

IS31LT3360

40V/1.2A LED DRIVER WITH INTERNAL SWITCH

January 2014

GENERAL DESCRIPTION

The IS31LT3360 is a continuous mode inductive step-down converter, designed for driving a single LED or multiple series connected LEDs efficiently from a voltage source higher than the LED voltage. The chip operates from an input supply between 6V and 40V and provides an externally adjustable output current of up to 1.2A.

The IS31LT3360 includes an integrated output switch and a high-side output current sensing circuit, which uses an external resistor to set the nominal average output current.

Output current can be adjusted linearly by applying an external control signal to the ADJ pin. The ADJ pin will accept either a DC voltage or a PWM waveform. This will provide either a continuous or a gated output current.

Applying a voltage less than 0.2V to the ADJ pin turns the output off and switches the chip into a low current standby state.

The chip is assembled in SOT89-5 package. It operates from 6V to 40V over two temperature ranges of -40°C to +105°C and -40°C to +125°C.

FEATURES

- Up to 1.2A output current
- High efficiency (up to 98%)
- Wide input voltage range: 6V ~ 40V
- Internal 40V power switch
- Simple low parts count
- Typical 3% output current accuracy (-40°C to +105°C, IS31LT3360-SDLS3-TR)
- Typical 5% output current accuracy (-40°C to +125°C, IS31LT3360-SDLS4-TR)
- Single pin on/off and brightness control using DC voltage or PWM
- Up to 1MHz switching frequency
- Inherent LED open-circuit/short-circuit protection
- Thermal shutdown protection circuitry
- Up to 1200: 1 dimming ratio

APPLICATIONS

- Automotive and avionic lighting
- LED MR16, MR11 spot light
- LED street light
- PAR light
- Industrial lighting
- Refrigeration lights
- Other LED lighting

TYPICAL APPLICATION CIRCUIT

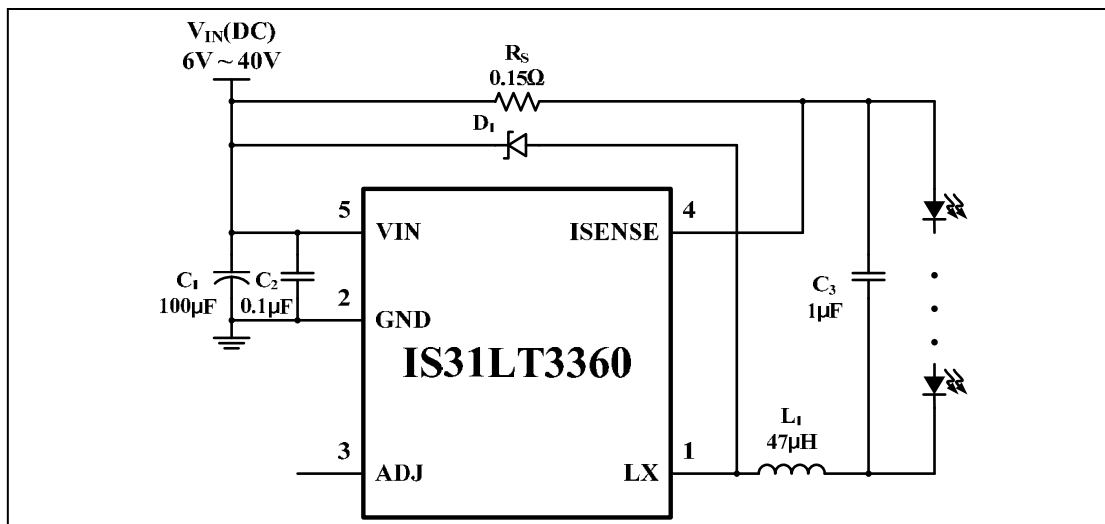
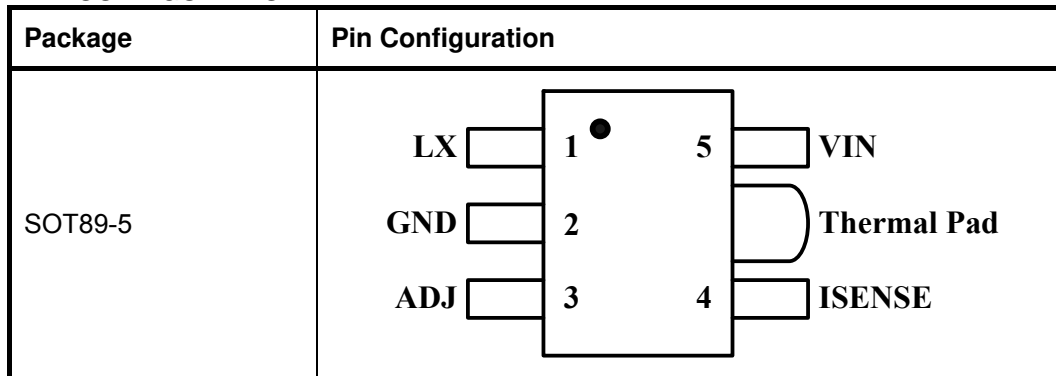

Figure 1 Typical Application Circuit

Note: The capacitor, C₂, can't be removed. And it should be placed as close as possible to the VIN and GND pins, otherwise the operation might be abnormal.

IS31LT3360

PIN CONFIGURATION



PIN DESCRIPTION

No.	Pin	Description
1	LX	Drain of power switch.
2	GND	Ground (0V).
3	ADJ	Multi-function On/Off and brightness control pin: * Leave floating for normal operation. ($V_{ADJ} = V_{REF} = 1.2V$ giving nominal average output current $I_{OUT(NOM)} = 0.1/R_S$) * Drive to voltage below 0.2V to turn off output current * Drive with DC voltage ($0.3V < V_{ADJ} < 1.2V$) to adjust output current from 25% to 100% of I_{OUT_NOM} * Drive with PWM signal to adjust output current. * When driving the ADJ pin above 1.2V, the current will be clamped to 100% brightness automatically.
4	ISENSE	Connect resistor R_S from this pin to V_{IN} to define nominal average output current $I_{OUT_NOM} = 0.1/R_S$
5	VIN	Input voltage (6V ~ 40V). Decouple to ground with 0.1 μ F X7R ceramic capacitor as close to device as possible.
	Thermal Pad	Connect to GND.

IS31LT3360

ORDERING INFORMATION

Industrial Range: -40°C to +105°C

Order Part No.	Package	QTY/Reel
IS31LT3360-SDLS3-TR	SOT89-5, Lead-free	2500

Industrial Range: -40°C to +125°C

Order Part No.	Package	QTY/Reel
IS31LT3360-SDLS4-TR	SOT89-5, Lead-free	2500

Copyright © 2014 Lumissil Microsystems. All rights reserved. Lumissil Microsystems reserves the right to make changes to this specification and its products at any time without notice. Lumissil Microsystems assumes no liability arising out of the application or use of any information, products or services described herein. Customers are advised to obtain the latest version of this device specification before relying on any published information and before placing orders for products.

Lumissil Microsystems does not recommend the use of any of its products in life support applications where the failure or malfunction of the product can reasonably be expected to cause failure of the life support system or to significantly affect its safety or effectiveness. Products are not authorized for use in such applications unless Lumissil Microsystems receives written assurance to its satisfaction, that:

- a.) the risk of injury or damage has been minimized;
- b.) the user assume all such risks; and
- c.) potential liability of Lumissil Microsystems is adequately protected under the circumstances

IS31LT3360

ABSOLUTE MAXIMUM RATINGS (NOTE 1)

Input voltage, V_{IN}	-0.3V ~ +50V
ISENSE voltage, V_{SENSE}	$V_{IN}-5V \sim V_{IN}+0.3V, V_{IN} \geq 5V$
	$-0.3V \sim V_{IN}+0.3V, V_{IN} < 5V$
LX output voltage, V_{LX}	-0.3V ~ +50V
Adjust pin input voltage, V_{ADJ}	-0.3V ~ +6.0V
Switch output current, I_{LX}	1.5A
Power dissipation, $P_{D(MAX)}$ (Note 2)	0.94W
Operating temperature, $T_A = T_J$	-40°C ~ +105°C, IS31LT3360-SDLS3-TR
	-40°C ~ +125°C, IS31LT3360-SDLS4-TR
Storage temperature, T_{ST}	-55°C ~ +150°C
Junction temperature, T_{JMAX}	150°C
Junction to ambient, θ_{JA}	132.6°C/W
ESD (HBM)	±4kV
ESD (CDM)	±750V

Note 1: Stresses beyond those listed under “Absolute Maximum Ratings” may cause permanent damage to the device. These are stress ratings only and functional operation of the device at these or any other condition beyond those indicated in the operational sections of the specifications is not implied. Exposure to absolute maximum rating conditions for extended periods may affect device reliability.

Note 2: Detail information please refer to package thermal de-rating curve on Page 12.

ELECTRICAL CHARACTERISTICS

Valid are at $V_{IN} = 12V$, typical value at 25°C, unless otherwise noted.

○ Parameter range based on $T_A = -40^\circ\text{C} \sim +125^\circ\text{C}$ (Note 3)

The symbol in the table means these parameters are only available in the above temperature range.

Symbol	Parameter	Conditions	Temp.	Min.	Typ.	Max.	Unit
V_{IN}	Input voltage			6		40	V
I_{INQ_OFF}	Quiescent supply current with output off	ADJ pin grounded		80	120	160	μA
			○	60	120	200	
I_{INQ_ON}	Quiescent supply current with output switching	ADJ pin floating			450	600	μA
			○		450	680	
V_{SENSE}	Mean current sense threshold voltage			97	100	103	mV
			○	95	100	105	
$V_{SENSEHYS}$	Sense threshold hysteresis				±15		%
I_{SENSE}	I_{SENSE} pin input current	$V_{SENSE} = V_{IN} - 0.1V$			8		μA
V_{REF}	Internal reference voltage	Measured on ADJ pin with pin floating			1.2		V
V_{ADJ}	External control voltage range on ADJ pin for dc brightness control			0.3		1.2	V
V_{ADJ_OFF}	DC voltage on ADJ pin to switch chip from active (on) state to quiescent (off) state	V_{ADJ} falling		0.15	0.2	0.25	V
			○	0.11	0.2	0.29	
V_{ADJ_ON}	DC voltage on ADJ pin to switch chip from quiescent (off) state to active (on) state	V_{ADJ} rising		0.2	0.25	0.3	V
			○	0.16	0.25	0.34	

IS31LT3360

ELECTRICAL CHARACTERISTICS (CONTINUED)

Valid are at $V_{IN} = 12V$, typical value at 25°C, unless otherwise noted.

○ Parameter range based on $T_A = -40^{\circ}C \sim +125^{\circ}C$ (Note 3)

The symbol in the table means these parameters are only available in the above temperature range.

Symbol	Parameter	Conditions	Temp.	Min.	Typ.	Max.	Unit
R_{ADJ}	Resistance between ADJ pin and V_{REF}				500		k Ω
I_{LX_LEAK}	LX switch leakage current					1	μA
			○			2.5	
I_{LX_MEAN}	Continuous LX switch current	(Note 4)			1.2		A
R_{LX}	LX switch 'ON' resistance				0.27	0.4	Ω
			○		0.27	0.7	
t_{ON_MIN}	Minimum switch 'ON' time	LX switch 'ON'			200		ns
t_{OFF_MIN}	Minimum switch 'OFF' time	LX switch 'OFF'			200		ns
t_{PD}	Internal comparator propagation delay	(Note 4)			50		ns
T_{SD}	Thermal shutdown temperature	(Note 4)			150		$^{\circ}C$
T_{SD_HYS}	Thermal shutdown hysteresis	(Note 4)			20		$^{\circ}C$

Note 3: Production testing of the device is performed at 25°C. Functional operation of the device and parameters specified over -40°C to +125°C temperature range, are guaranteed by design, characterization and process control.

Note 4: Guaranteed by design.

IS31LT3360

TYPICAL PERFORMANCE CHARACTERISTICS

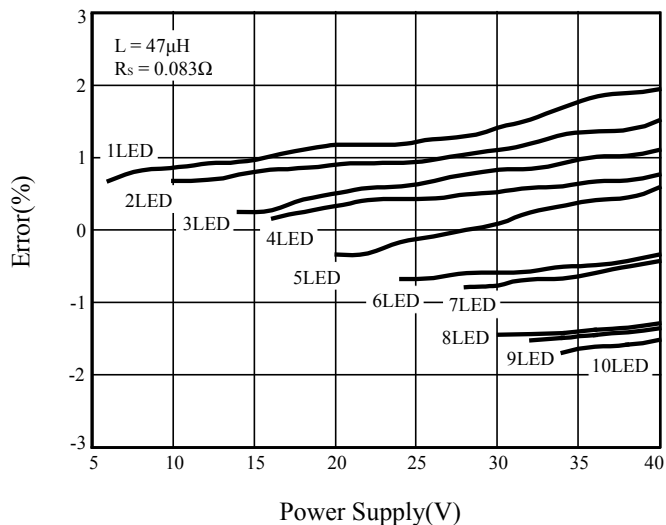

Figure 2 Output Current Error vs. Power Supply

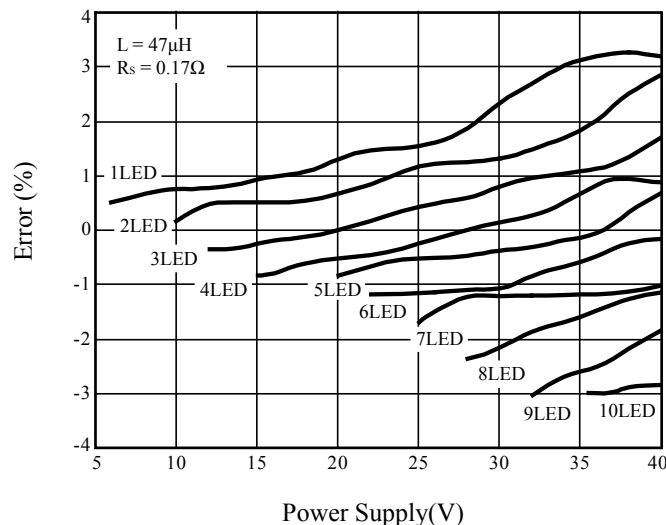

Figure 3 Output Current Error vs. Power Supply

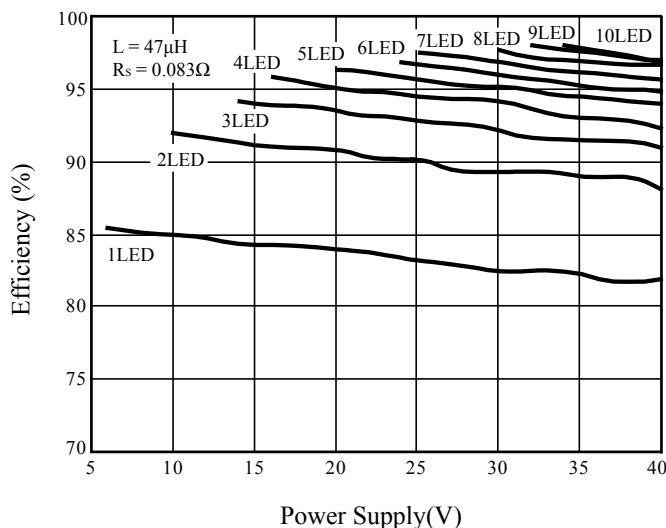

Figure 4 Efficiency vs. Power Supply

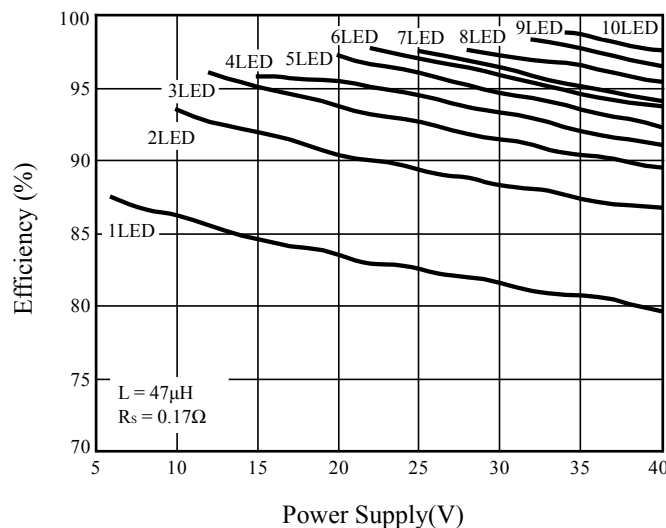

Figure 5 Efficiency vs. Power Supply

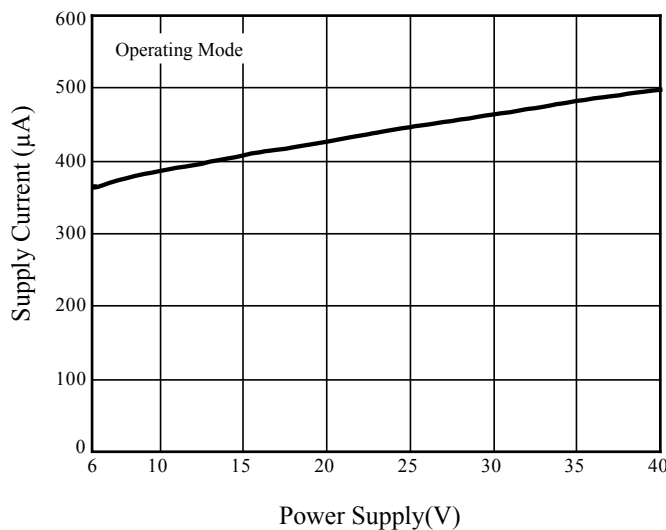

Figure 6 Supply Current vs. Power Supply (Operating Mode)

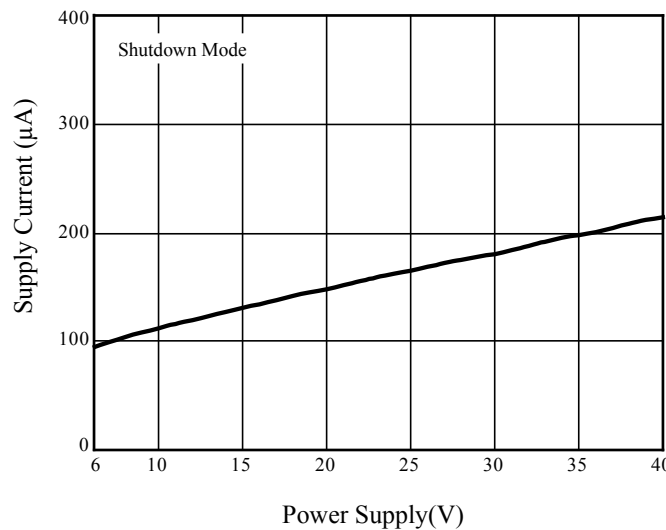

Figure 7 Supply Current vs. Power Supply (Shutdown Mode)

IS31LT3360

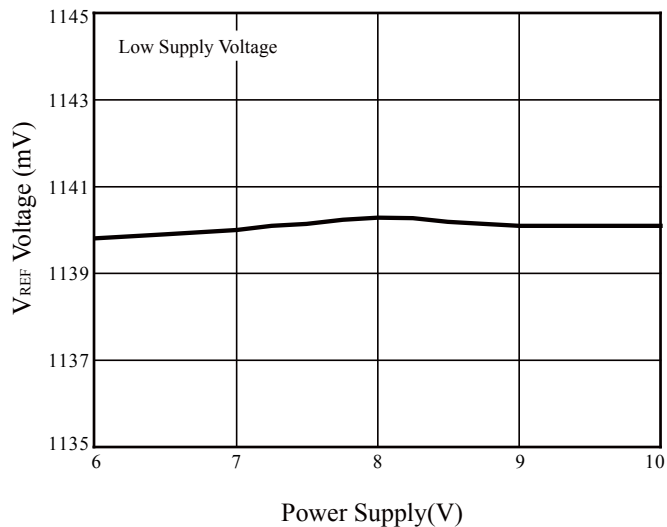

Figure 8 V_{REF} vs. Power Supply (Low Supply Voltage)

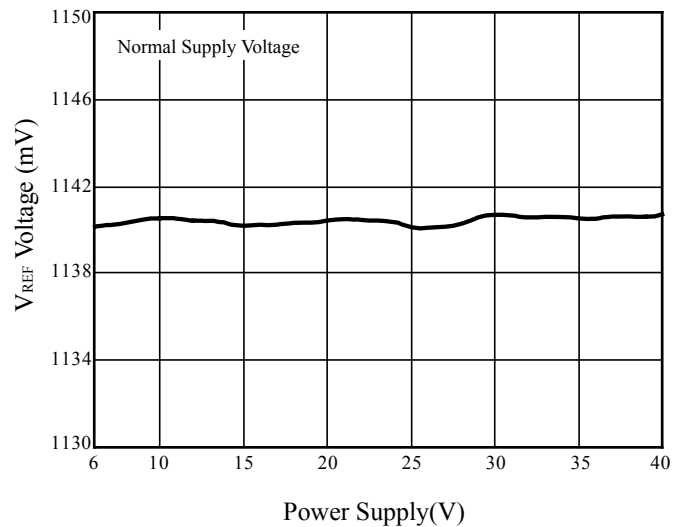

Figure 9 V_{REF} vs. Power Supply (Normal Supply Voltage)

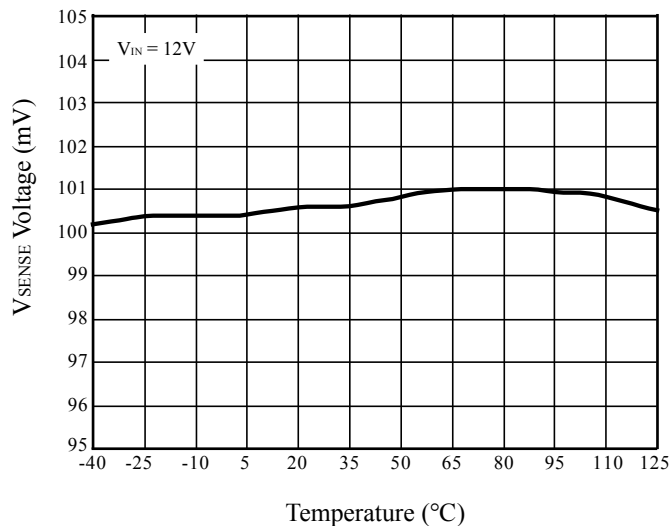

Figure 10 V_{SENSE} vs. Temperature

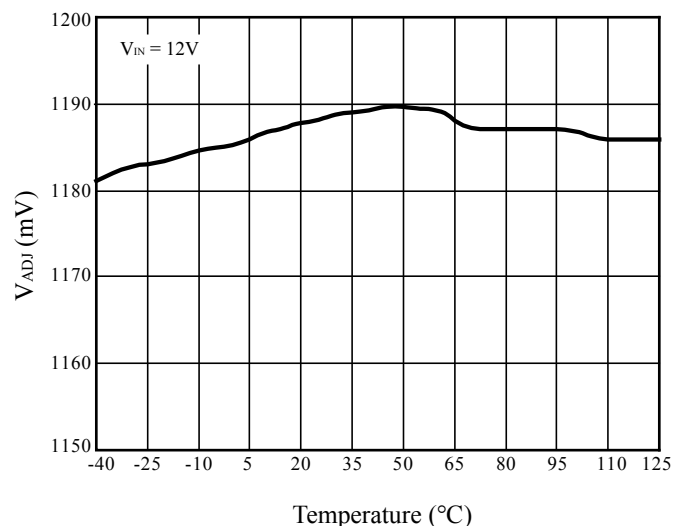

Figure 11 V_{ADJ} vs. Temperature

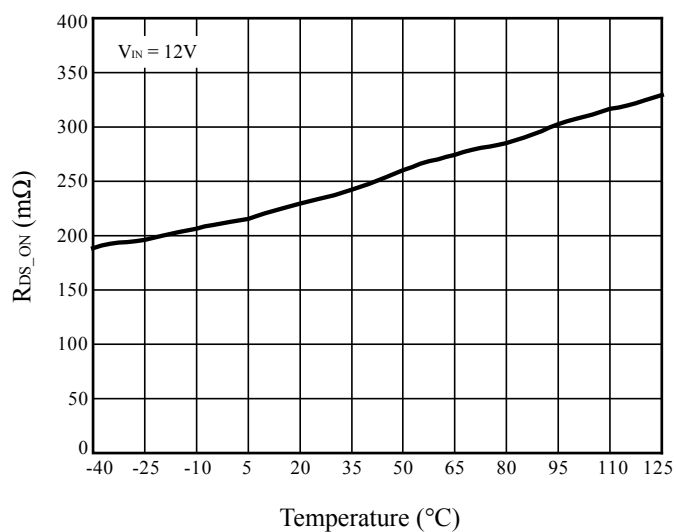

Figure 12 R_{DS_ON} vs. Temperature

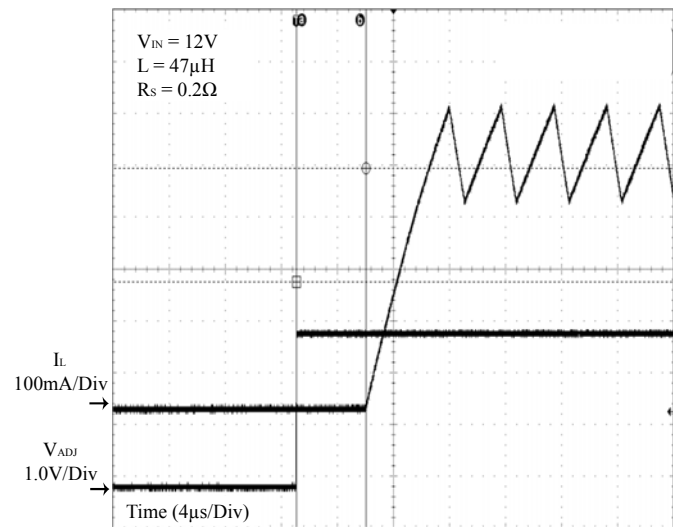

Figure 13 ADJ Pin Voltage vs. I_L

IS31LT3360

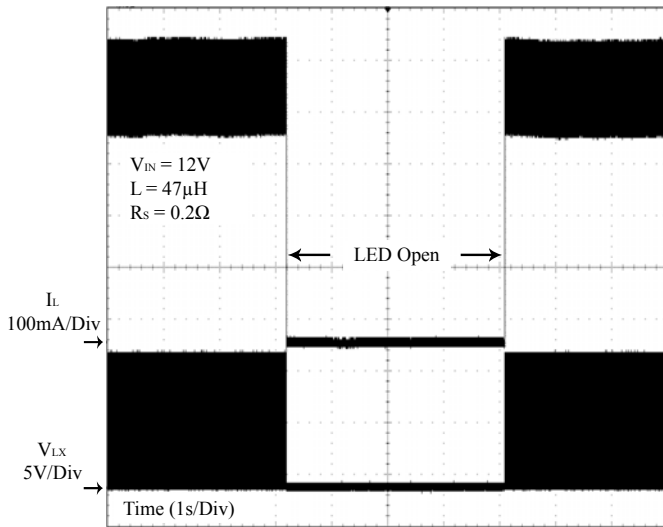

Figure 14 LED Open-Circuit Protection

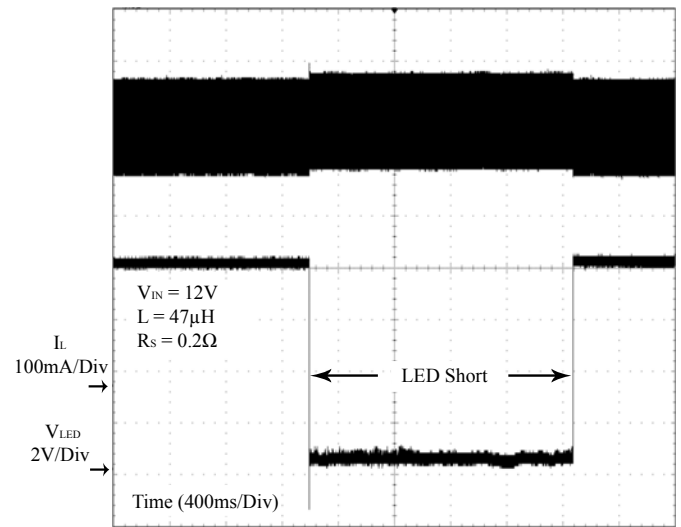
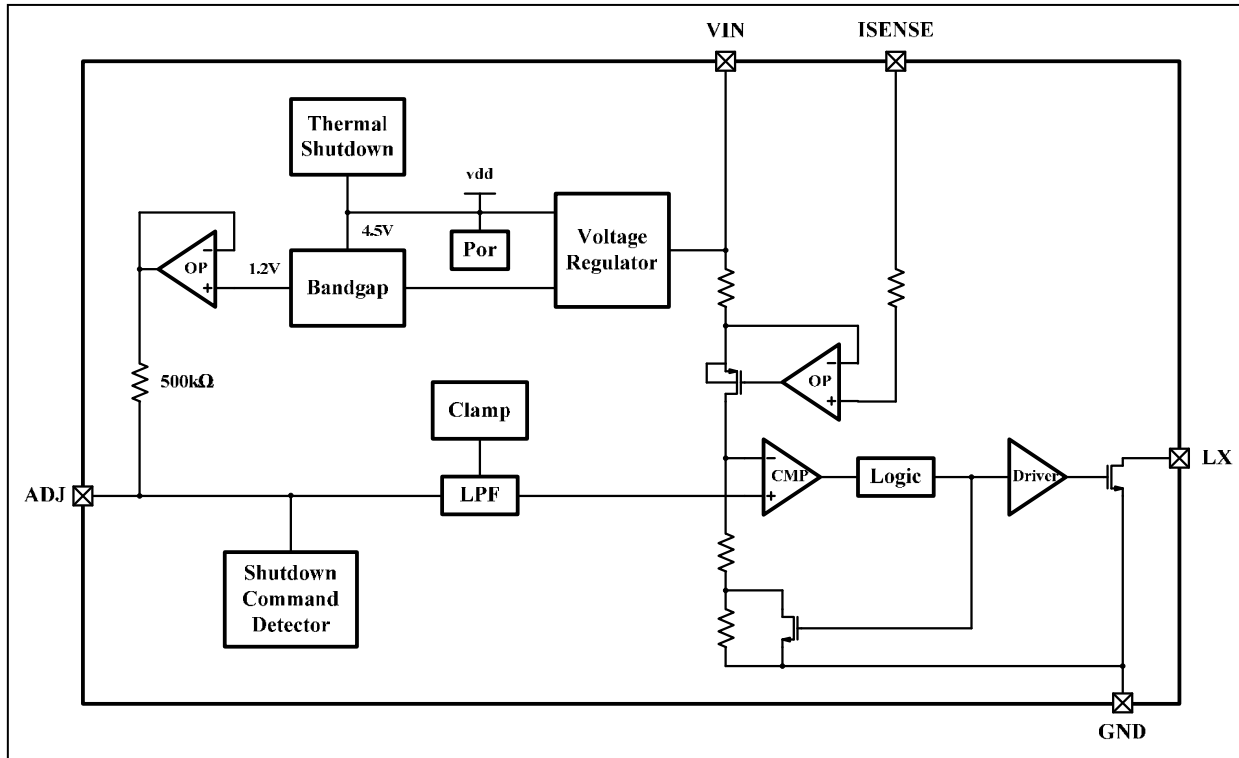

Figure 15 LED Short-Circuit Protection

IS31LT3360

FUNCTIONAL BLOCK DIAGRAM



IS31LT3360

APPLICATION INFORMATION

SETTING NOMINAL AVERAGE OUTPUT CURRENT WITH EXTERNAL RESISTOR R_S

The nominal average output current in the LED(s) is determined by the value of the external current sense resistor (R_S) connected between VIN and ISENSE pins and in is given by Equation (1):

$$I_{OUT_NOM} = \frac{0.1}{R_S} \quad (1)$$

Note that $R_S=0.083\Omega$ is the minimum allowed value of sense resistor under these conditions to maintain switch current below the specified maximum value. It is possible to use different values of R_S if the ADJ pin is driven from an external voltage.

The table below gives values of nominal average output current for several preferred values of current setting resistor (R_S) in the typical application circuit Figure 1:

R_S (Ω)	Nominal Average Output Current (mA)
0.083	1200
0.15	667
0.3	333

The above values assume that the ADJ pin is floating and at a nominal voltage of $V_{REF} = 1.2V$.

R_S need to be chosen 1% accuracy resistor with enough power tolerance and good temperature characteristic to ensure stable output current.

OUTPUT CURRENT ADJUSTMENT BY EXTERNAL DC CONTROL VOLTAGE

The ADJ pin can be driven by an external DC voltage (V_{ADJ}), as shown in Figure 16, to adjust the output current to a value above or below the nominal average value defined by R_S .

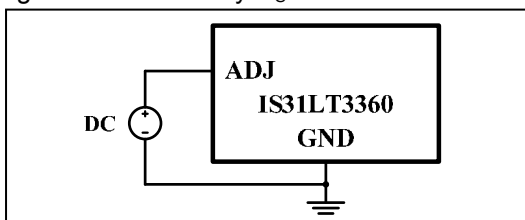

Figure 16 Dimming by External DC Voltage

The nominal average output current in this case is given by Equation (2):

$$I_{OUT_DC} = \frac{0.083 \times V_{ADJ}}{R_S} \quad (2)$$

For $0.3V < V_{ADJ} < 1.2V$.

Note that 100% brightness setting corresponds to $V_{ADJ} = V_{REF}$. When driving the ADJ pin above 1.2V,

the current will be clamped to 100% brightness automatically.

The input impedance of the ADJ pin is 500k Ω (Typ.).

OUTPUT CURRENT ADJUSTMENT BY PWM CONTROL

Directly Driving ADJ Input

A Pulse Width Modulated (PWM) signal with duty cycle D_{PWM} can be applied to the ADJ pin, as shown in Figure 17, to adjust the output current to a value below the nominal average value set by resistor R_S , the signal range is from 0V~5V. The logic "HIGH" is higher than 1.2V, the logic "LOW" is lower than 0.2V. The PWM signal must have the driving ability to drive internal 500k Ω pull-up resistor.

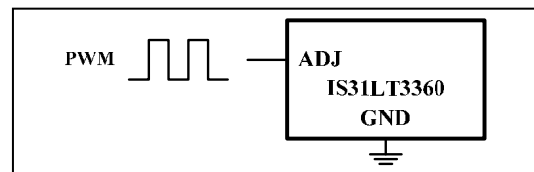

Figure 17 PWM Dimming Control Via ADJ Pin

Driving The ADJ Input From A Microcontroller

Another possibility is to drive the chip from the open drain output of a microcontroller. The Figure 18 below shows one method of doing this:

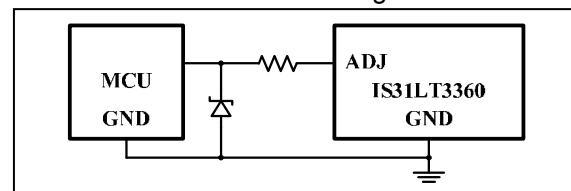

Figure 18 Dimming By MCU

The diode and resistor suppress possible high amplitude negative spikes on the ADJ input resulting from the drain-source capacitance of the FET. Negative spikes at the input to the chip should be avoided as they may cause errors in output current or erratic device operation.

SHUTDOWN MODE

Taking the ADJ pin to a voltage below 0.2V will turn off the output and supply current will fall to a low standby level of 120 μ A nominal.

INHERENT OPEN-CIRCUIT LED PROTECTION

If the connection to the LED(s) is open-circuited, the coil is isolated from the LX pin of the chip, so the chip will not be damaged, unlike in many boost converters, where the back EMF may damage the internal switch by forcing the drain above its breakdown voltage.

CAPACITOR SELECTION

A low ESR capacitor should be used for input decoupling, as the ESR of this capacitor appears in

IS31LT3360

series with the supply source impedance and lowers overall efficiency. This capacitor has to supply the relatively high peak current to the coil and smooth the current ripple on the input supply.

If the source is DC supply, the capacitor is decided by ripple of the source, the value is given by Equation (3):

$$C_{MIN} = \frac{I_F \times t_{ON}}{\Delta U_{MAX}} \quad (3)$$

I_F is the value of output current, ΔU_{MAX} is the ripple of power supply. t_{ON} is the "ON" time of MOSFET.

The value is higher than the minimum value. A 100 μ F capacitor is recommended.

If the source is an AC supply, typical output voltages ripple from a nominal 12V AC transformer can be $\pm 10\%$. If the input capacitor value is lower than 220 μ F, the AC input waveform is distorted, sometimes the lowest value will be lower than the forward voltage of LED strings. This lower the average current of the LEDs. So it is recommended to set the value of the capacitor bigger than 220 μ F.

INDUCTOR SELECTION

Recommended inductor values for the IS31LT3360 are in the range 47 μ H to 220 μ H.

Higher values of inductance are recommended at higher supply voltages and low output current in order to minimize errors due to switching delays, which result in increased ripple and lower efficiency. Higher values of inductance also result in a smaller change in output current over the supply voltage range. The inductor should be mounted as close to the chip as possible with low resistance connections to the LX and VIN pins.

The chosen coil should have a saturation current higher than the peak output current and a continuous current rating above the required mean output current. It is recommended to use inductor with saturation current bigger than 1.2A for 700mA output current and inductor with saturation current bigger than 500mA for 350mA output current.

The inductor value should be chosen to maintain operating duty cycle and switch 'on/off' times within the specified limits over the supply voltage and load current range.

The following equations can be used as a guide.

LX Switch 'ON' time:

$$t_{ON} = \frac{L \times \Delta I}{V_{IN} - V_{LED} - I_{AVG} (R_S + R_L + R_{LX})} \quad (4)$$

Note: $t_{ON_MIN} > 200ns$.

LX Switch 'OFF' time:

$$t_{OFF} = \frac{L \times \Delta I}{V_{LED} + V_D + I_{AVG} (R_L + R_S)} \quad (5)$$

Note: $t_{OFF_MIN} > 200ns$.

Where:

L is the coil inductance (H)

R_L is the coil resistance (Ω)

I_{AVG} is the required LED current (A)

ΔI is the coil peak-peak ripple current (A) {Internally set to $0.3 \times I_{AVG}$ }

V_{IN} is the supply voltage (V)

V_{LED} is the total LED forward voltage (V)

R_{LX} is the switch resistance (Ω)

V_D is the diode forward voltage at the required load current (V)

Example:

For $V_{IN}=12V$, $L=47\mu H$, $R_L=0.26\Omega$, $V_{LED}=3.4V$, $I_{AVG}=333mA$, $V_D=0.36V$, $R_S=0.3\Omega$, $R_{LX}=0.27\Omega$:

$$t_{ON} = \frac{47 \times 0.3 \times 0.333}{12 - 3.4 - 0.333 \times (0.3 + 0.26 + 0.27)} \approx 0.564 \mu s$$

$$t_{OFF} = \frac{47 \times 0.3 \times 0.333}{3.4 + 0.36 + 0.333 \times (0.26 + 0.3)} \approx 1.19 \mu s$$

This gives an operating frequency of 570kHz and a duty cycle of 32%.

Optimum performance will be achieved by setting the duty cycle close to 50% at the nominal supply voltage. This helps to equalize the undershoot and overshoot and improves temperature stability of the output current.

DIODE SELECTION

For maximum efficiency and performance, the rectifier (D_1) should be a fast low capacitance Schottky diode with low reverse leakage at the maximum operating voltage and temperature.

If alternative diodes are used, it is important to select parts with a peak current rating above the peak coil current and a continuous current rating higher than the maximum output load current. It is very important to consider the reverse leakage of the diode when operating at high temperature. Excess leakage will increase the power dissipation in the device.

The higher forward voltage and overshoot due to reverse recovery time in silicon diodes will increase the peak voltage on the LX output. If a silicon diode is used, care should be taken to ensure that the total voltage appearing on the LX pin including supply ripple, does not exceed the specified maximum value.

IS31LT3360

REDUCING OUTPUT RIPPLE

A value of 1µF will reduce nominal ripple current by a factor three (approx.). Proportionally lower ripple can be achieved with higher capacitor values. Note that the capacitor will not affect operating frequency or efficiency, but it will increase start-up delay, by reducing the rate of rise of LED voltage.

OPERATION AT LOW SUPPLY VOLTAGE

The internal regulator disables the drive to the switch until the supply has risen above the startup threshold set internally which makes power MOSFET on-resistance small enough. Above this threshold, the chip will start to operate. However, with the supply voltage below the specified minimum value, the switch duty cycle will be high and the chip power dissipation will be at a maximum. Care should be taken to avoid operating the chip under such conditions in the application, in order to minimize the risk of exceeding the maximum allowed die temperature. (See next section on thermal considerations).

Note that when driving loads of two or more LEDs, the forward drop will normally be sufficient to prevent the chip from switching below approximately 6V. This will minimize the risk of damage to the chip.

THERMAL CONSIDERATIONS

When operating the chip at high ambient temperatures, or when driving maximum load current, care must be taken to avoid exceeding the package power dissipation limits. The maximum power dissipation can be calculated using the following Equation (6):

$$P_{D(MAX)} = \frac{T_{J(MAX)} - T_A}{\theta_{JA}} \quad (6)$$

Where $T_{J(MAX)}$ is the maximum junction temperature, T_A is the ambient temperature, and θ_{JA} is the junction to ambient thermal resistance.

The recommended maximum operating junction temperature, $T_{J(MAX)}$, is 150°C and so maximum ambient temperature is determined by the junction to ambient thermal resistance, θ_{JA} .

Therefore the maximum power dissipation at $T_A = 25^\circ\text{C}$ is:

$$P_{D(MAX)} = \frac{150^\circ\text{C} - 25^\circ\text{C}}{132.6^\circ\text{C}/\text{W}} \approx 0.94\text{W}$$

To ensure the performance, the die temperature (T_J) of IS31LT3360 should not exceed 125°C. The graph below gives details for power derating.

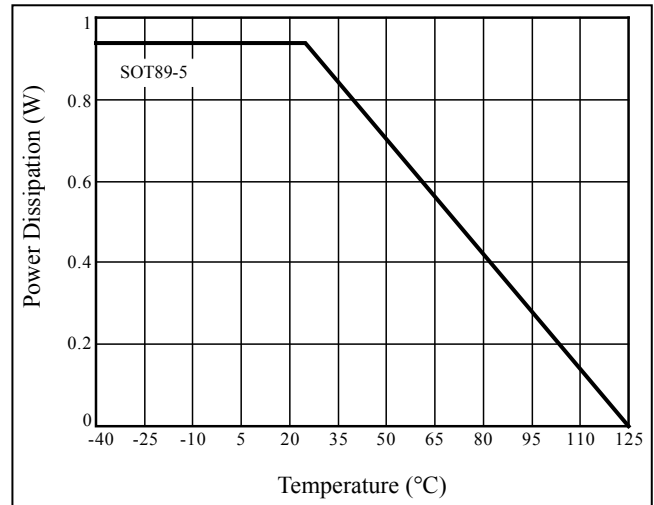

Figure 19 P_D vs. T_A

It will also increase if the efficiency of the circuit is low. This may result from the use of unsuitable coils, or excessive parasitic output capacitance on the switch output.

LAYOUT CONSIDERATIONS

VIN Pin

The GND of power supply usually have some distance to the chip GND pin, which cause parasitic resistance and inductance. It causes ground voltage bounce while the MOSFET is switching. Connect a 0.1µF capacitor C_2 as close to device as possible to minimize the ground bounce.

LX Pin

The LX pin of the chip is a fast switching node, so PCB traces should be kept as short as possible. To minimize ground 'bounce', the ground pin of the chip should be soldered directly to the ground plane.

Coil And Decoupling Capacitor C_1

It is particularly important to mount the coil and the input decoupling capacitor close to the chip to minimize parasitic resistance and inductance, which will degrade efficiency. It is also important to take account of any trace resistance in series with current sense resistor R_S .

ADJ Pin

The ADJ pin is a high impedance input, so when left floating, PCB traces to this pin should be as short as possible to reduce noise pickup. ADJ pin can also be connected to a voltage between 1.2V~5V. In this case, the internal circuit will clamp the output current at the value which is set by $V_{ADJ} = 1.2\text{V}$.

IS31LT3360

High Voltage Traces

Avoid running any high voltage traces close to the ADJ pin, to reduce the risk of leakage due to board contamination. Any such leakage may affect the ADJ pin voltage and cause unexpectable output current. The IS31LT3360 has external protection circuitry to prevent excessive output current if ADJ voltage rises above 1.2V. A ground ring placed around the ADJ pin will minimize changes in output current under these conditions.

IS31LT3360

CLASSIFICATION REFLOW PROFILES

Profile Feature	Pb-Free Assembly
Preheat & Soak Temperature min (T _{smin}) Temperature max (T _{smax}) Time (T _{smin} to T _{smax}) (t _s)	150°C 200°C 60-120 seconds
Average ramp-up rate (T _{smax} to T _p)	3°C/second max.
Liquidous temperature (T _L) Time at liquidous (t _L)	217°C 60-150 seconds
Peak package body temperature (T _p)*	Max 260°C
Time (t _p)** within 5°C of the specified classification temperature (T _c)	Max 30 seconds
Average ramp-down rate (T _p to T _{smax})	6°C/second max.
Time 25°C to peak temperature	8 minutes max.

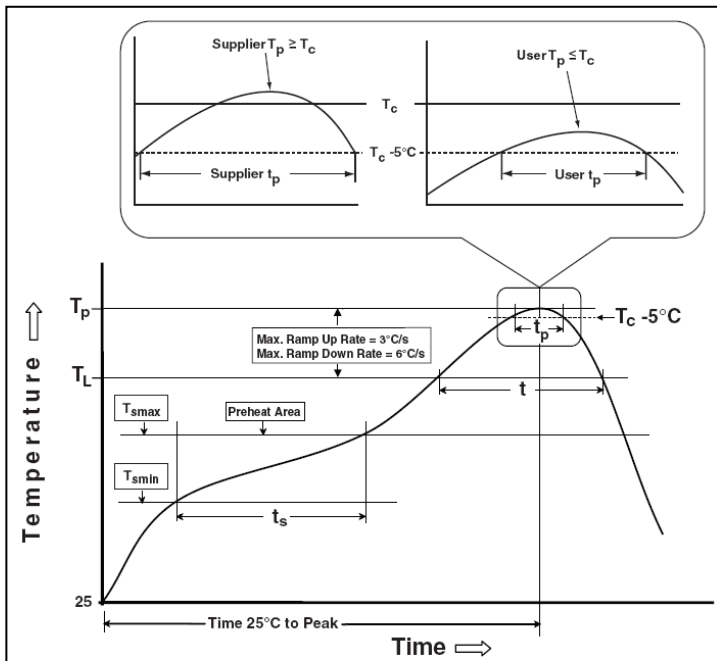
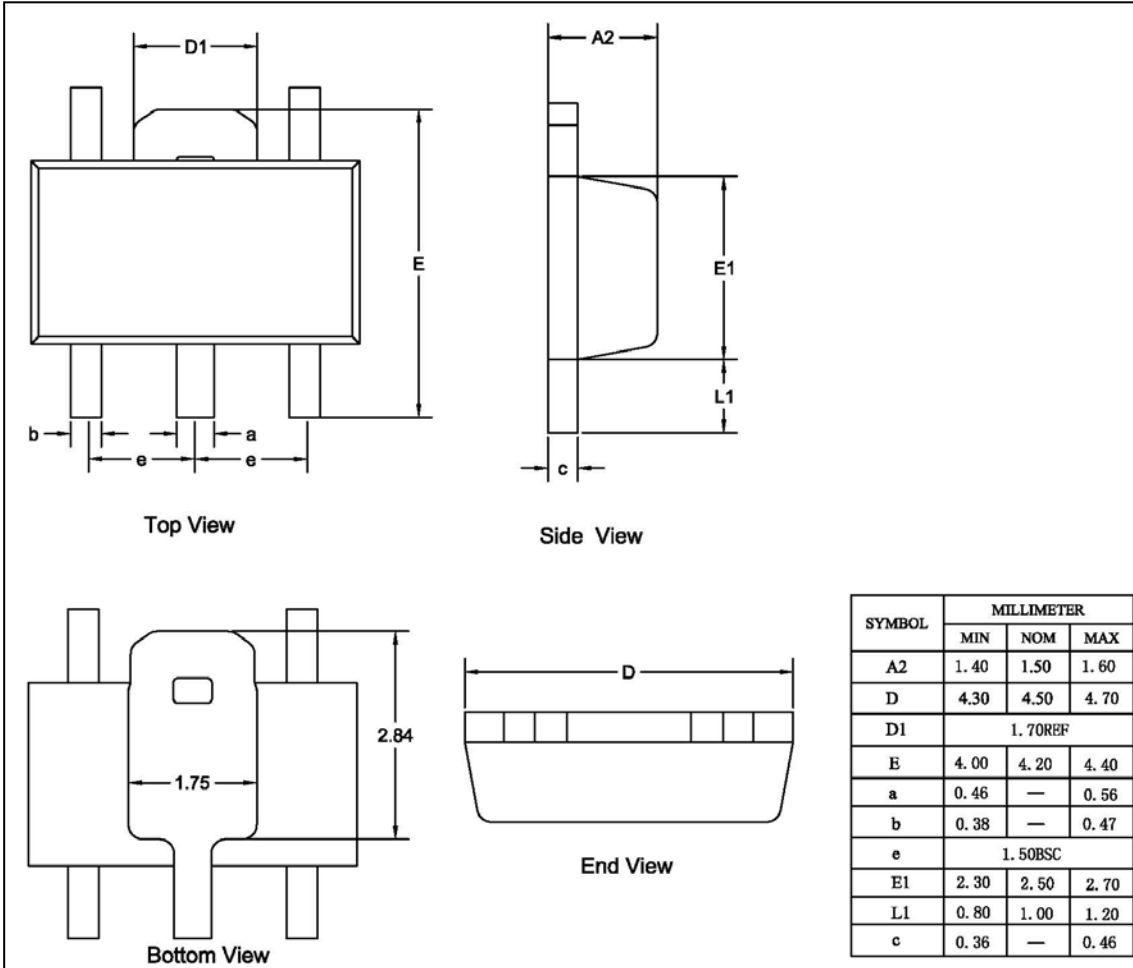

Figure 20 Classification Profile

IS31LT3360

PACKAGE INFORMATION

SOT89-5



Note: All dimensions in millimeters unless otherwise stated.