



AC/DC Converter

Built-in SiC MOSFET Isolation Fly-back Converter

Quasi-Resonant method 48 W 24 V

BM2SC123FP2-LBZ Reference Board

<High Voltage Safety Precautions>

◇ Read all safety precautions before use

Please note that this document covers only the BM2SC123FP2-LBZ evaluation board (BM2SC123FP2-EVK-001) and its functions. For additional information, please refer to the datasheet.

To ensure safe operation, please carefully read all precautions before handling the evaluation board



Depending on the configuration of the board and voltages used,

Potentially lethal voltages may be generated.

Therefore, please make sure to read and observe all safety precautions described in the red box below.

Before Use

- [1] Verify that the parts/components are not damaged or missing (i.e. due to the drops).
- [2] Check that there are no conductive foreign objects on the board.
- [3] Be careful when performing soldering on the module and/or evaluation board to ensure that solder splash does not occur.
- [4] Check that there is no condensation or water droplets on the circuit board.

During Use

- [5] Be careful to not allow conductive objects to come into contact with the board.
- [6] **Brief accidental contact or even bringing your hand close to the board may result in discharge and lead to severe injury or death.**

Therefore, DO NOT touch the board with your bare hands or bring them too close to the board.

In addition, as mentioned above please exercise extreme caution when using conductive tools such as tweezers and screwdrivers.

- [7] If used under conditions beyond its rated voltage, it may cause defects such as short-circuit or, depending on the circumstances, explosion or other permanent damages.
- [8] Be sure to wear insulated gloves when handling is required during operation.

After Use

- [9] The ROHM Evaluation Board contains the circuits which store the high voltage. Since it stores the charges even after the connected power circuits are cut, please discharge the electricity after using it, and please deal with it after confirming such electric discharge.
- [10] Protect against electric shocks by wearing insulated gloves when handling.

This evaluation board is intended for use only in research and development facilities and should be handled **only by qualified personnel familiar with all safety and operating procedures.**

We recommend carrying out operation in a safe environment that includes the use of high voltage signage at all entrances, safety interlocks, and protective glasses.

AC/DC Converter

Built-in SiC MOSFET Isolated Fly-back Converter QR method Output 48 W 24 V BM2SC123FP2-LBZ Reference Board BM2SC123FP2-EVK-001

Feature

- (1) Built-in 1700 V SiC MOSFET
- (2) Wide input voltage range by SiC MOSFET: DC = 300 V to 900 V, AC = 210 Vac to 480 Vac
- (3) High power surface mount type package TO263-7L.
- (4) This is a ranked product that guarantees a long-term supply for the industrial equipment market.



Figure 1. BM2SC123FP2-EVK-001

Electrical Specification

Input Conditions

Parameter	Min	Typ	Max	Units	Conditions
Input Voltage Range (DC)	300	-	900	V	
Input Voltage Range (AC)	210	-	480	Vac	
Input AC Frequency	47	50 / 60	63	Hz	
Operating Temperature Range	-10	+25	+65	°C	

Electrical Characteristics

Not guarantee the characteristics, is representative value. Unless otherwise noted: $V_{IN} = 600\text{ V (DC)}$, $I_o = 1.0\text{ A}$, $T_a = 25\text{ °C}$

Parameter	Min	Typ	Max	Units	Conditions
Output Voltage	22.8	24.0	25.2	V	
Maximum Output Power	-	-	48	W	$I_o = 2\text{ A}$
Output Current Range <i>(Note 1)</i>	0.0	-	2.0	A	
Stand-by Power	-	310	-	mW	$I_o = 0\text{ A}$
Efficiency	-	91	-	%	$I_o = 2\text{ A}$, $V_{IN}=300\text{ V(DC)}$
Output Ripple Voltage <i>(Note 2)</i>	-	-	200	mVpp	

(Note 1) Adjust operating time, within any parts surface temperature under 105 °C

(Note 2) Not include spike noise

Operation Procedure

1. Operation Equipment

- (1) 3 Phase AC Power supply 210 Vac to 480 Vac, or DC Power supply 300 Vdc to 900 Vdc. (80 W or more)
- (2) Electronic Load capacity 2.0 A
- (3) DC voltage meter

2. Connect method

- (1) Turn off each power supply and connect the measuring instrument as shown below.
 - (2) Set the power supply within the usage range and turn on the power.
 - (3) If using electronic load, set it between 0 A to 2 A.
 - (4) Connect the output DC voltage meter directly to the output and measure the voltage by sensing.
 - (5) When removing the measuring instrument, set the input voltage to 0 V and check that the voltage of the input electrolytic capacitors C8, 9, 10 are 10 V or less. After that, turn off the power of each measuring instrument and remove it.
- (Note that you may get an electric shock if high voltage remains in the input capacitor.)

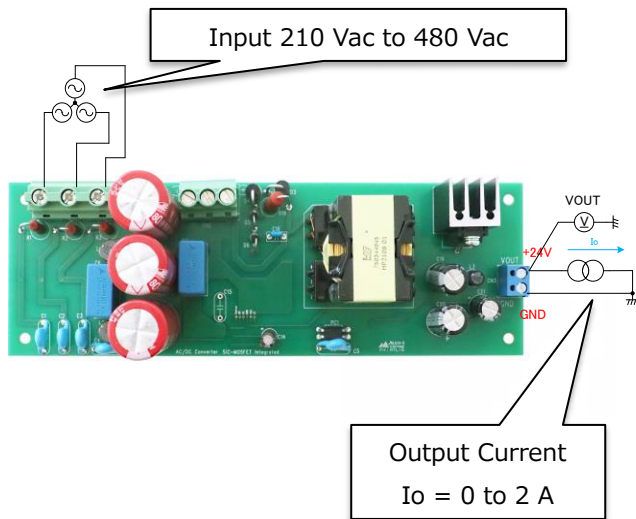

Figure 2. Input with 3-phase AC power supply

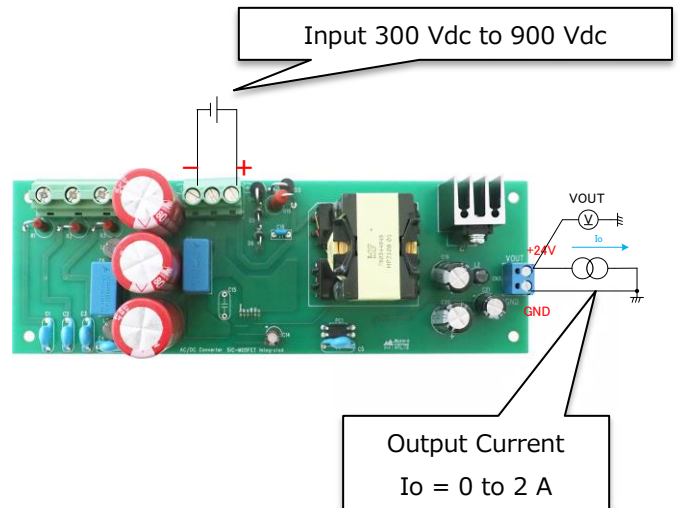
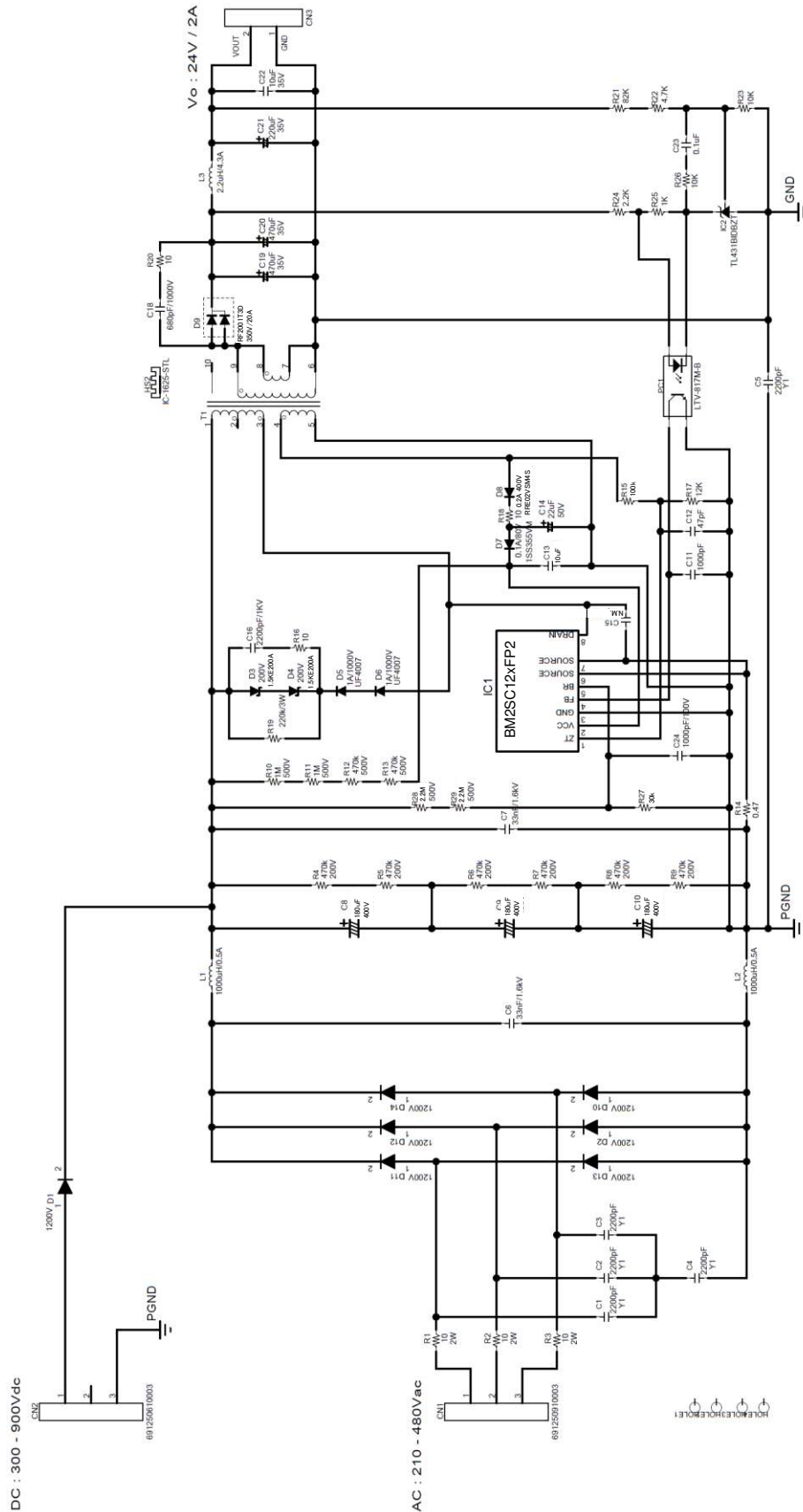

Figure 3. Inputting with DC power supply

Application Circuit



BOM LIST

Item		Specifications	Parts name	Manufacture
SCREW	-		SEMS-SCREW-P4-3X8	TOMOHO
CL	C1,C2,C3,C4,C5	2200 pF, 300 V	DE1E3RA222MJ4BP01F	MURATA
CFL	C6,C7	33 nF, 1600 V	B32672L1333J	TDK
CAL	C8,C9,C10	180 μF, 400 V	860021381024	WURTH ELECTRONIK
CAP	C11,C24	1000 pF, 100 V	HMK107B7102KA-T	TAIYO YUDEN
CAP	C12	47 pF, 250 V	GRM1885C2E470JW07	MURATA
CAP	C13	10 μF, 50 V	GRM31CD71H106KE11	MURATA
CAL	C14	22 μF, 50 V	UHD1H220MDD	NICHICON
OTHER	C15	-	NON MOUNTED	-
CL	C16	2200 pF, 1000 V	RDER73A222K2K1H03B	MURATA
CAP	C18	680 pF, 1000 V	GRM31B5C2J681FW01L	MURATA
CAL	C19,C20	470 μF, 35 V	EKZE350ELL471MJ20S	UNITED CHEMI-CON
CAL	C21	220 μF, 35 V	UHD1V221MPD	NICHICON
CAP	C22	10 μF, 50 V	GRM31CD71H106KE11	MURATA
CAP	C23	0.1 μF, 100 V	HMK107B7104MA-T	TAIYO YUDEN
CN	CN1	-	691250910003	WURTH ELECTRONIK
CN	CN2	-	691250610003	WURTH ELECTRONIK
CN	CN3	-	691101710002	WURTH ELECTRONIK
DI	D1,D2,D10,D11,D12,D13,D14	1 A, 1200 V	D1FK120	SHINDENGEN
ZD	D3,D4	Zener Diode, 200 V	1.5KE200A	LITTELFUSE
FRD	D5,D6	FRD, 1 A, 1000 V	UF4007	ON SEMICONDUCTOR
DI	D7	0.1 A, 80 V	1SS355VM	ROHM
DI	D8	0.2 A, 400 V	RRE02VSM4S	ROHM
FRD	D9	FRD, 20 A, 300 V	RF2001T3DNZ	ROHM
HS	HS2	22.9 k/W	IC-1625-STL	SANKYO THRMOTECH
IC	IC1	-	BM2SC123FP2-LBZ	ROHM
IC	IC2	-	TL431BIDBZT	TI
L	L1,L2	1000 μH	768772102	WURTH ELECTRONIK
L	L3	2.2 μH	7447462022	WURTH ELECTRONIK
PC	PC1	-	LTV-817M-B	LITEON
RES	R1,R2,R3	10 Ω	PR02FS0201009KR500	VISHAY
RES	R4,R5,R6,R7,R8,R9	470 kΩ	MCR18EZPJ474	ROHM
RES	R10,R11	1 MΩ	KTR18EZPJ105	ROHM
RES	R12,R13	470 kΩ	KTR18EZPJ474	ROHM
RES	R14	0.47 Ω	LTR100JZPFLR470	ROHM
RES	R15	100 kΩ	KTR03EZFX1003	ROHM
RES	R16,R20	10 Ω	MCR25JZHJ100	ROHM
RES	R17	12 kΩ	MCR03EZPFX1202	ROHM
RES	R18	10 Ω	MCR18EZPJ100	ROHM
RES	R19	220 kΩ	PR03000202203JAC00	VISHAY
RES	R21	82 kΩ	MCR03EZPFX8202	ROHM
RES	R22	4.7 kΩ	MCR03EZPFX4701	ROHM
RES	R23,R26	10 kΩ	MCR03EZPFX1002	ROHM
RES	R24	2.2 kΩ	MCR03EZPFX2201	ROHM
RES	R25	1 kΩ	MCR03EZPFX1001	ROHM
RES	R27	30 kΩ	MCR03EZPJ303	ROHM
RES	R28,R29	470 kΩ	KTR18EZPJ225	ROHM
T	T1	PQ3230	750344945	WURTH ELECTRONIK

BM2SC12xFP2 Overview

Feature

- Long Time Support Product for Industrial Applications
- TO263-7L Package
- Built-in 1700 V/9.2 A/1.15 Ω SiC-MOSFET
- Quasi-resonant Type
- Frequency Reduction Function
- Low Current Consumption (19 μA) during Standby
- Burst Operation at Light Load
- SOURCE Pin Leading Edge Blanking
- VCC UVLO (Under Voltage Lockout protection)
- VCC OVP (Over Voltage Protection)
- Over Current Protection Circuit per Cycle
- Soft Start Function
- ZT Pin Trigger Mask Function
- ZT OVP (Over Voltage Protection)
- BR UVLO (Under Voltage Lockout Protection)

Key specifications

- Operating Power Supply Voltage Range:
 - VCC: 15.0 V to 27.5 V
 - DRAIN: 1700 V (Max)
- Normal Operating Current: 800 μA (Typ)
- Burst Operating Current: 500 μA (Typ)
- Maximum Operating Frequency: 120 kHz (Typ)
- Operating Temperature: -40 °C to +105 °C

Table 1. Series Line-up

Product name	FB OLP	VCC OVP
BM2SCQ121FP2-LBZ	Auto Restart	Latch
BM2SCQ122FP2-LBZ	Latch	Latch
BM2SCQ123FP2-LBZ	Auto Restart	Auto Restart
BM2SCQ124FP2-LBZ	Latch	Auto Restart

Application

Power supply for Industrial Equipment, AC Adaptor, Household Application

Package

TO263-7L

W (Typ) x D (Typ) x H (Max)

10.18 mm x 15.5 mm x 4.56 mm

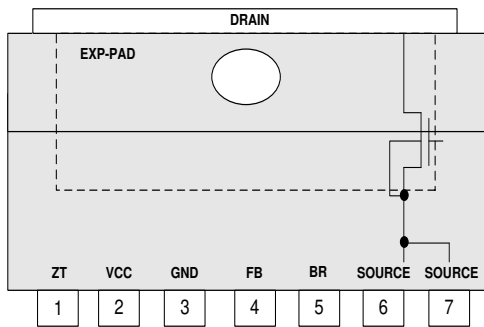

Figure 4. Pin Configuration

Table 2. BM2SC123FP2 PIN description

No.	Name	Function
1	ZT	Zero current detection pin
2	VCC	Power supply input pin
3	GND	GND pin
4	FB	Feedback signal input pin
5	BR	AC voltage detect pin
6	SOURCE	MOSFET SOURCE pin
7	SOURCE	MOSFET SOURCE pin
EXP-PAD	DRAIN	MOSFET DRAIN pin

Transformer Specification

Transformer design example

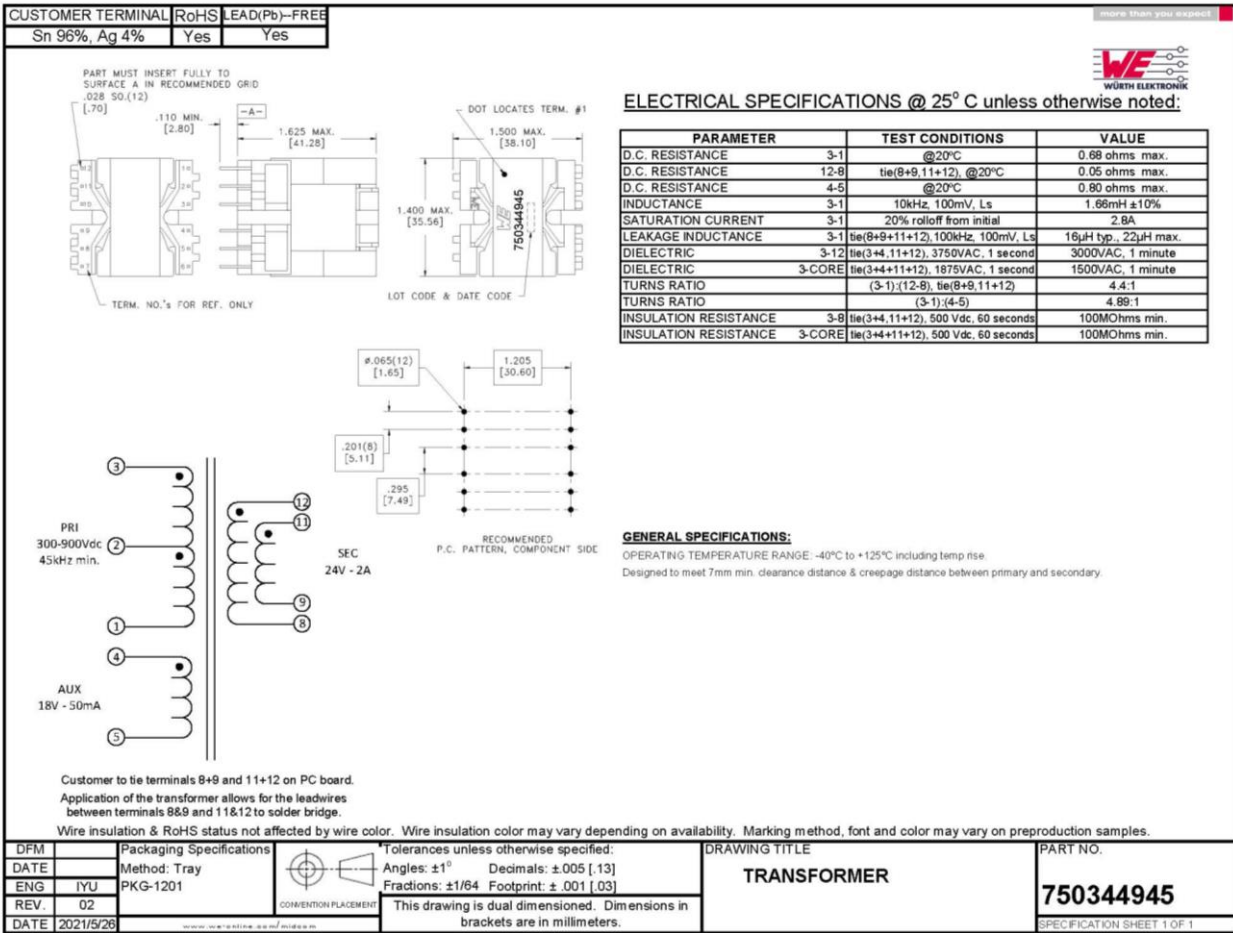

Figure 5. Transformer Specification

Table 3. Core and Bobbin Information

Item	Material
Core	TP4A
Bobbin	PQ3230 WH9100

Table 4. Winding Specification

Pin	Turn No.	Wire diagram
3=>1 pin	88T	AWG25
11=>9 pin, 12=>8 pin	20T	4 x AWG24
4 pin=>5 pin	18T	AWG32

Performance Data

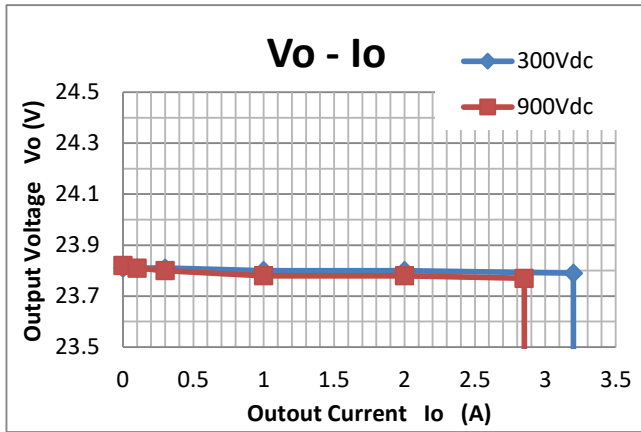

Figure 6. Output Voltage vs Output Current –

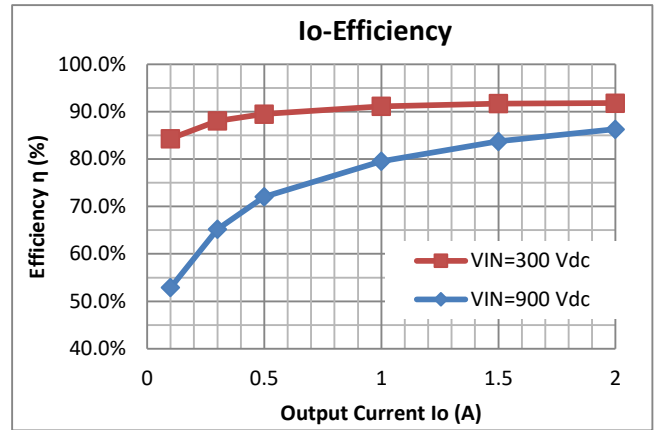

Figure 7. Output Current vs Efficiency

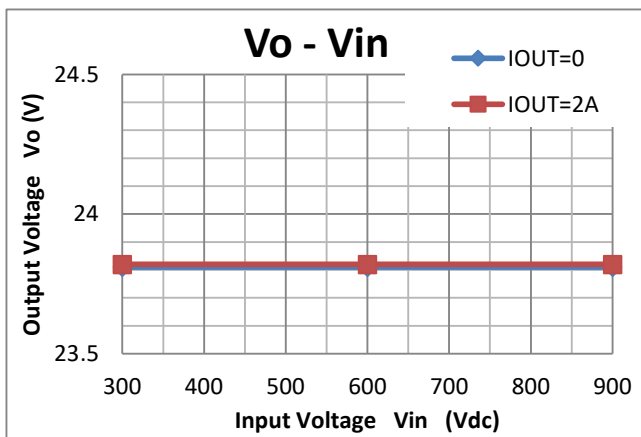

Figure 8. Input Voltage vs Output Voltage

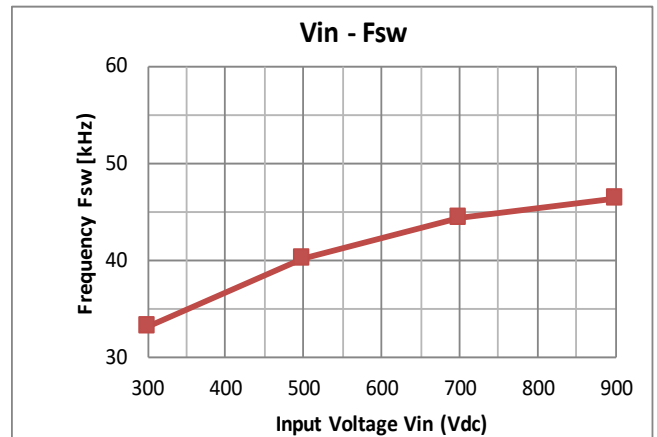

Figure 9. Input Voltage V_{in} vs Frequency ($I_o = 2$ A)

Performance Data – Continued

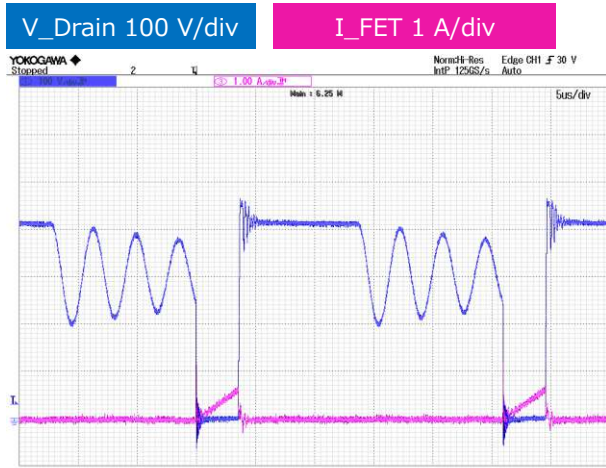

Figure 10. $V_{in_dc} = 300\text{ V}$, $I_o = 0.5\text{ A}$
Primary Side

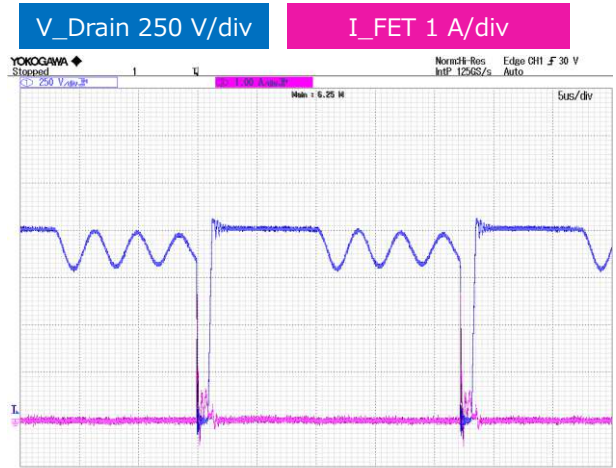

Figure 11. $V_{in_dc} = 900\text{ V}$, $I_o = 0.5\text{ A}$
Primary Side

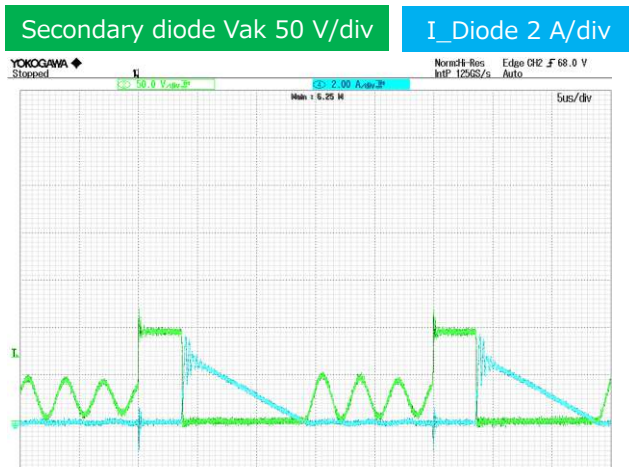

Figure 12. $V_{in_dc} = 300\text{ V}$, $I_o = 0.5\text{ A}$
Secondary Side

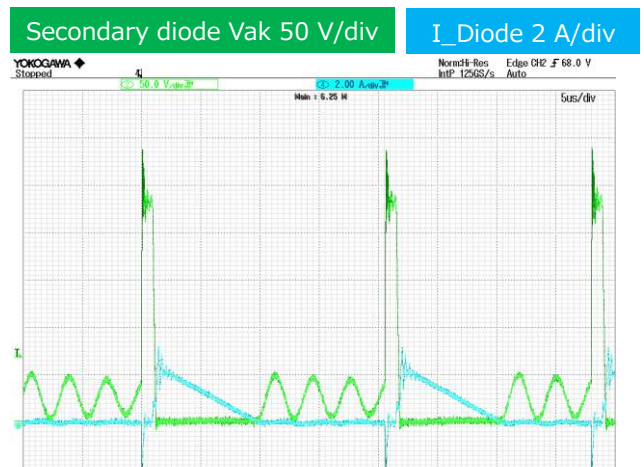

Figure 13. $V_{in_dc} = 900\text{ V}$, $I_o = 0.5\text{ A}$
Secondary Side

Performance Data – Continued

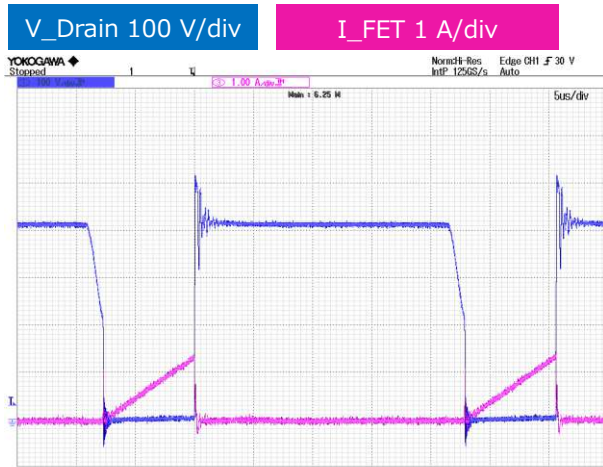

Figure 14. $V_{in_dc} = 300\text{ V}$, $I_o = 2.0\text{ A}$
Primary Side

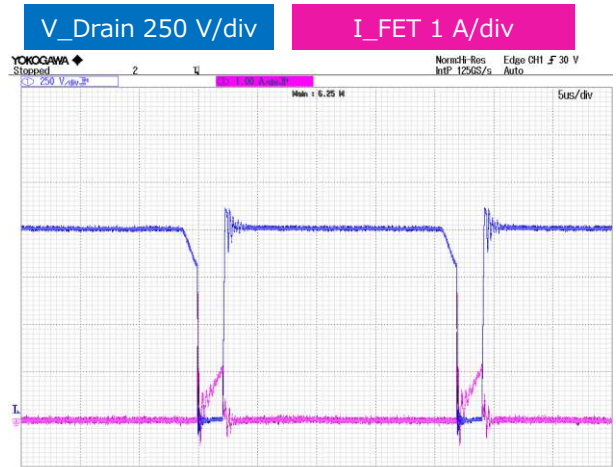

Figure 15. $V_{in_dc} = 900\text{ V}$, $I_o = 2.0\text{ A}$
Primary Side

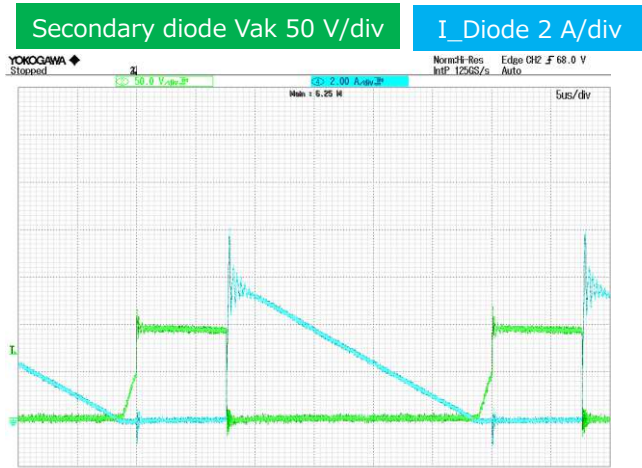

Figure 16. $V_{in_dc} = 300\text{ V}$, $I_o = 2.0\text{ A}$
Secondary Side

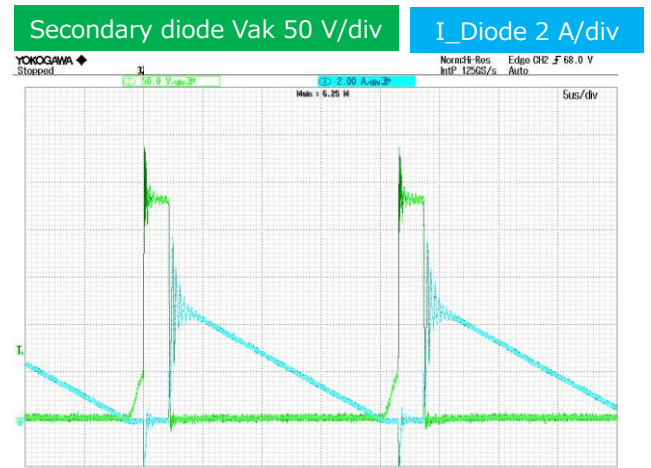

Figure 17. $V_{in_dc} = 900\text{ V}$, $I_o = 2.0\text{ A}$
Secondary Side

Performance Data – Continued

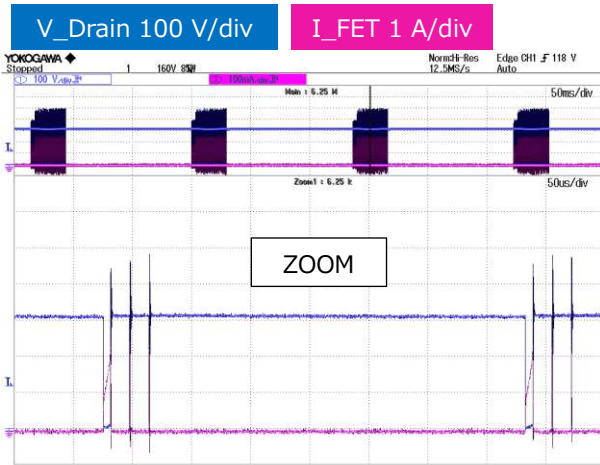

Figure 18. Output short $V_{in_dc} = 300\text{ V}$
Primary side



Figure 19. Output short $V_{in_dc} = 900\text{ V}$
Primary side

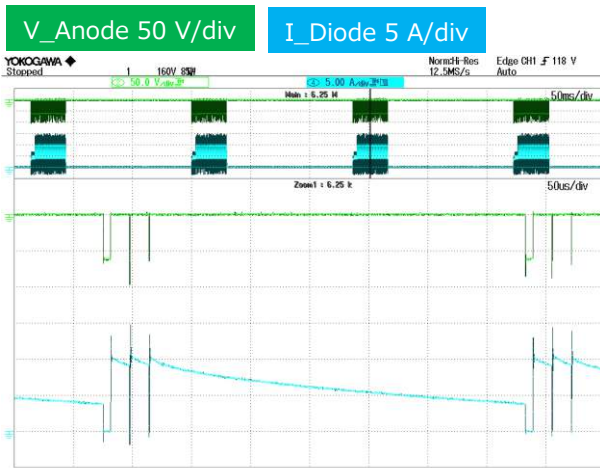

Figure 20. Output short $V_{in_dc} = 300\text{ V}$
Secondary side

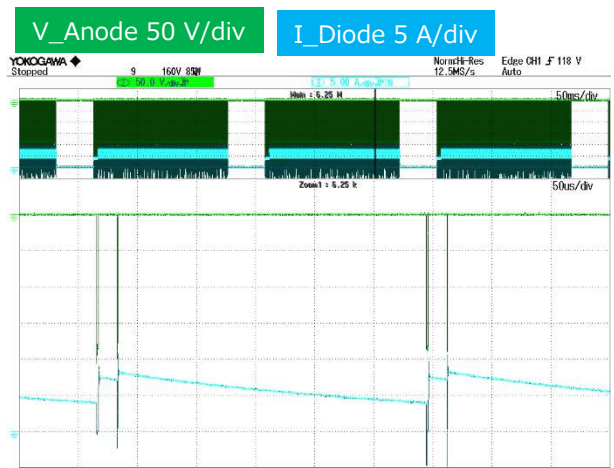

Figure 21. Output short $V_{in_dc} = 900\text{ V}$
Secondary side

Performance Data – Continued

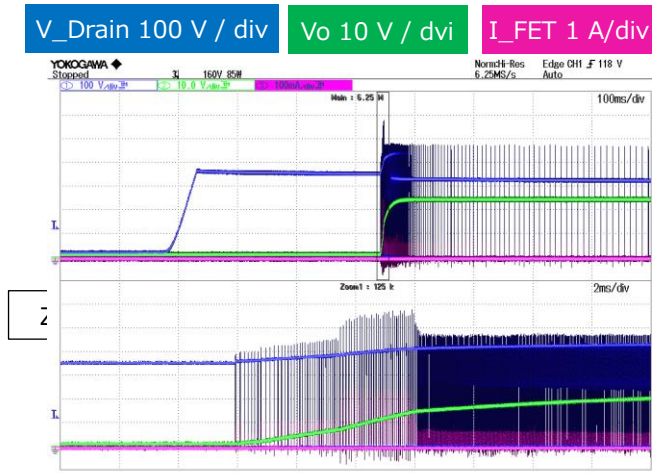

Figure 22. Startup $V_{in_dc} = 300\text{ V}$, $I_o = 0\text{ A}$

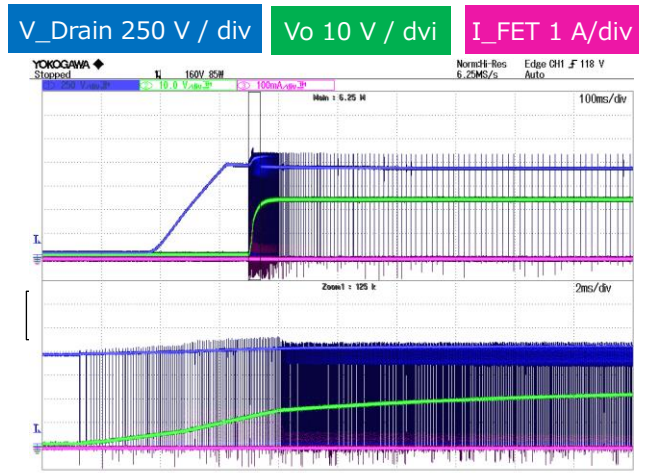

Figure 23. Startup $V_{in_dc} = 900\text{ V}$, $I_o = 0\text{ A}$

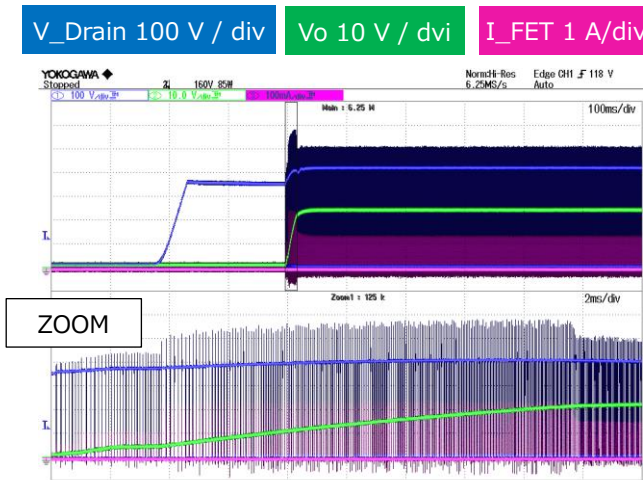

Figure 24. Startup $V_{in_dc} = 300\text{ V}$, $I_o = 2\text{ A}$

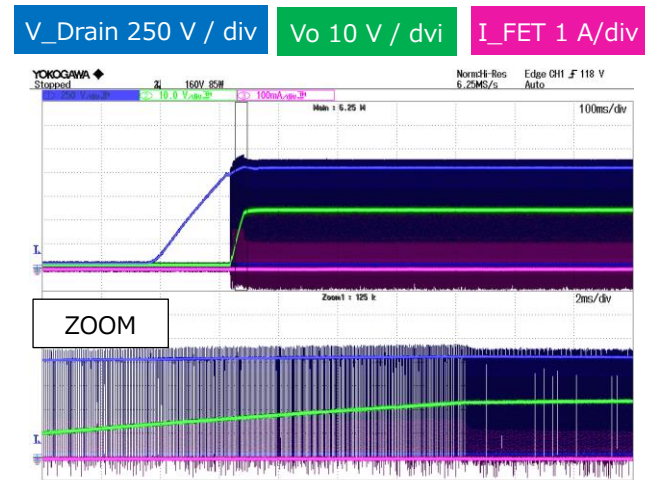

Figure 25. Startup $V_{in_dc} = 900\text{ V}$, $I_o = 2\text{ A}$

Performance Data – Continued

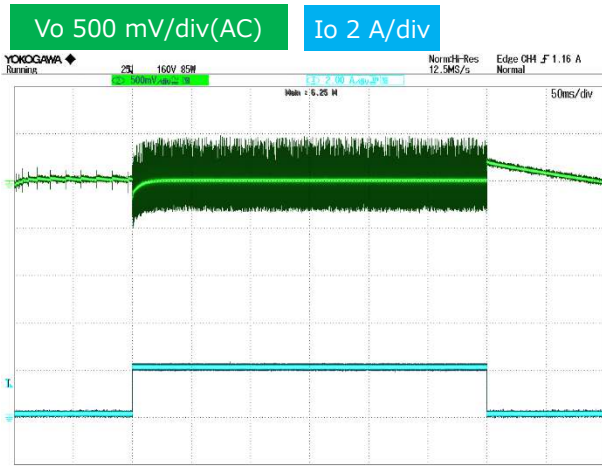

Figure 26. Load Response $V_{in_dc} = 300\text{ V}$, $I_o = 0 \rightarrow 2\text{ A}$

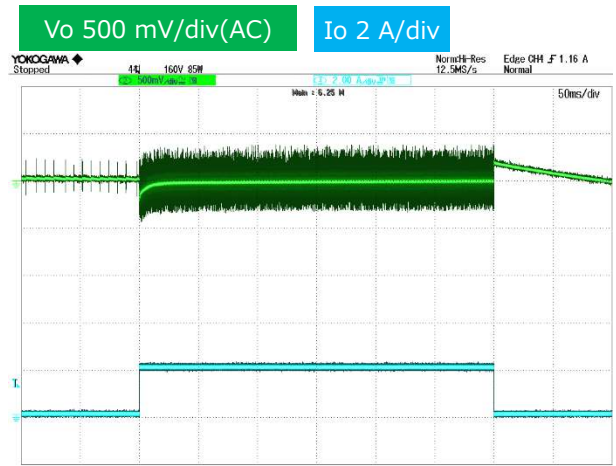

Figure 27. Load Response $V_{in_dc} = 900\text{ V}$, $I_o = 0 \rightarrow 2\text{ A}$

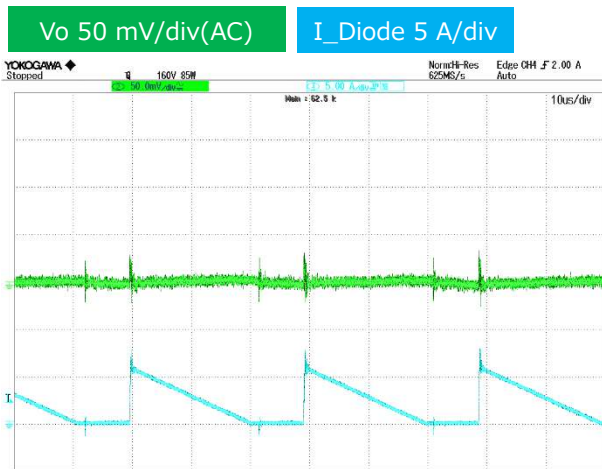

Figure 28. Output Ripple Voltage $V_{in_dc} = 300\text{ V}$,
 $I_o = 2\text{ A}$



Figure 29. Output Ripple Voltage $V_{in_dc} = 900\text{ V}$,
 $I_o = 2\text{ A}$

Performance Data – Continued

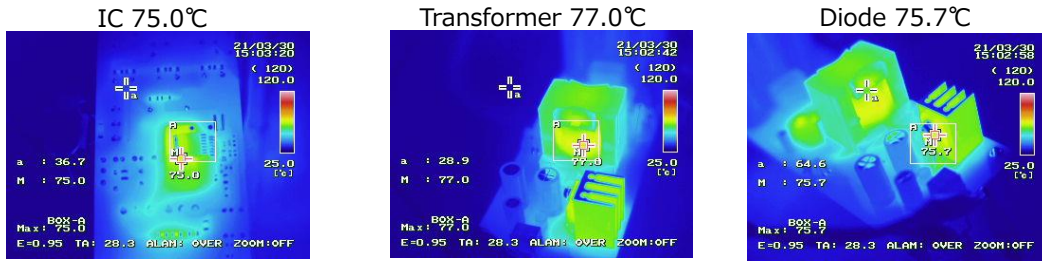

Figure 30. Parts surface temperature (Vin_dc = 900V, Iout = 2A after 30min.)

Consider selecting parts by checking the temperature range of the parts to be used.

PCB

Size : 60 mm x 180 mm

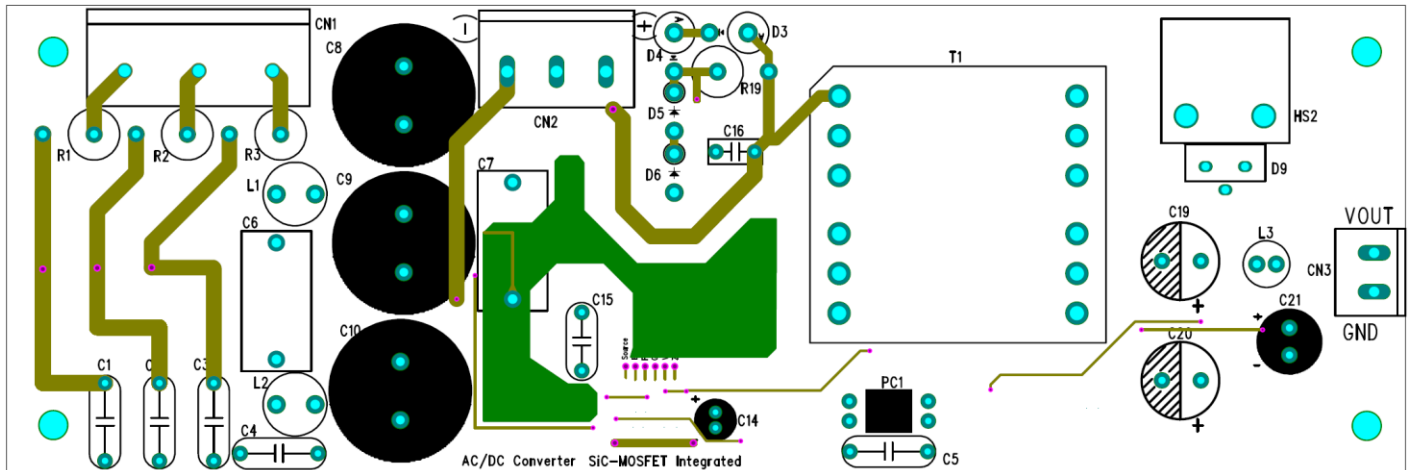

Figure 31. Top Layout (Top view)

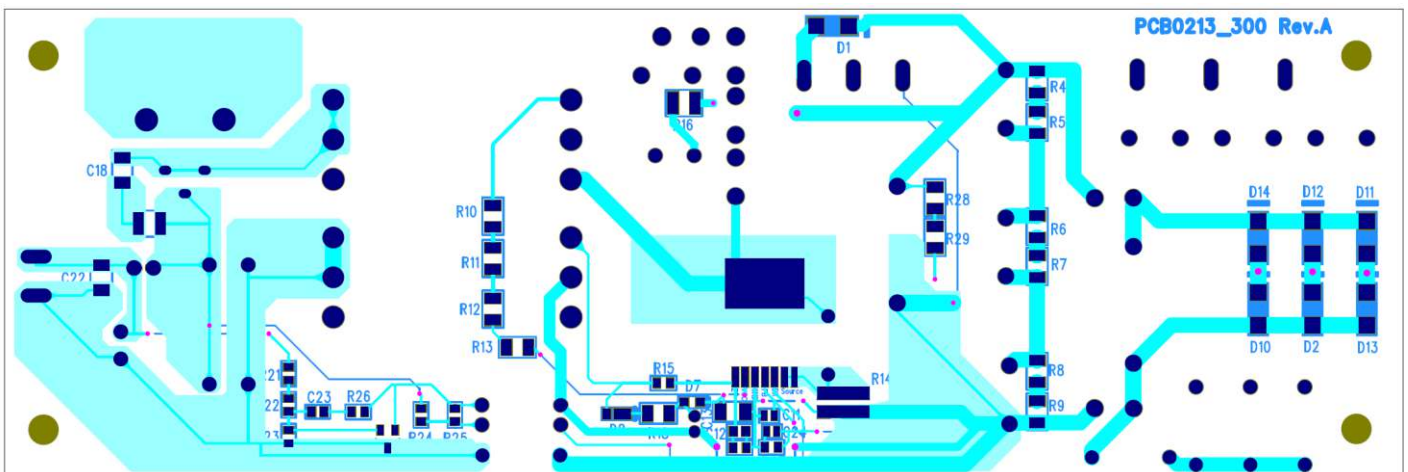

Figure 32. Bottom Layout (Bottom view)

Revision History

Date	Rev.	Changes
28.Apr.2021	001	New Release
1.Jun.2021	002	• P4 Transformer specification is modified • P6 Transformer specification modified
24.Jun.2021	003	• P4 Transformer name change

Notes

- 1) The information contained herein is subject to change without notice.
- 2) Before you use our Products, please contact our sales representative and verify the latest specifications :
- 3) Although ROHM is continuously working to improve product reliability and quality, semiconductors can break down and malfunction due to various factors.
Therefore, in order to prevent personal injury or fire arising from failure, please take safety measures such as complying with the derating characteristics, implementing redundant and fire prevention designs, and utilizing backups and fail-safe procedures. ROHM shall have no responsibility for any damages arising out of the use of our Products beyond the rating specified by ROHM.
- 4) Examples of application circuits, circuit constants and any other information contained herein are provided only to illustrate the standard usage and operations of the Products. The peripheral conditions must be taken into account when designing circuits for mass production.
- 5) The technical information specified herein is intended only to show the typical functions of and examples of application circuits for the Products. ROHM does not grant you, explicitly or implicitly, any license to use or exercise intellectual property or other rights held by ROHM or any other parties. ROHM shall have no responsibility whatsoever for any dispute arising out of the use of such technical information.
- 6) The Products specified in this document are not designed to be radiation tolerant.
- 7) For use of our Products in applications requiring a high degree of reliability (as exemplified below), please contact and consult with a ROHM representative : transportation equipment (i.e. cars, ships, trains), primary communication equipment, traffic lights, fire/crime prevention, safety equipment, medical systems, servers, solar cells, and power transmission systems.
- 8) Do not use our Products in applications requiring extremely high reliability, such as aerospace equipment, nuclear power control systems, and submarine repeaters.
- 9) ROHM shall have no responsibility for any damages or injury arising from non-compliance with the recommended usage conditions and specifications contained herein.
- 10) ROHM has used reasonable care to ensure the accuracy of the information contained in this document. However, ROHM does not warrants that such information is error-free, and ROHM shall have no responsibility for any damages arising from any inaccuracy or misprint of such information.
- 11) Please use the Products in accordance with any applicable environmental laws and regulations, such as the RoHS Directive. For more details, including RoHS compatibility, please contact a ROHM sales office. ROHM shall have no responsibility for any damages or losses resulting non-compliance with any applicable laws or regulations.
- 12) When providing our Products and technologies contained in this document to other countries, you must abide by the procedures and provisions stipulated in all applicable export laws and regulations, including without limitation the US Export Administration Regulations and the Foreign Exchange and Foreign Trade Act.
- 13) This document, in part or in whole, may not be reprinted or reproduced without prior consent of ROHM.



Thank you for your accessing to ROHM product informations.
More detail product informations and catalogs are available, please contact us.

ROHM Customer Support System

<http://www.rohm.com/contact/>