

# TLC2652, TLC2652A, TLC2652Y Advanced LinCMOS™ PRECISION CHOPPER-STABILIZED OPERATIONAL AMPLIFIERS

SLOS019E – SEPTEMBER 1988 – REVISED FEBRUARY 2005

- Extremely Low Offset Voltage . . . 1  $\mu$ V Max
- Extremely Low Change on Offset Voltage With Temperature . . . 0.003  $\mu$ V/°C Typ
- Low Input Offset Current  
500 pA Max at  $T_A = -55^\circ\text{C}$  to  $125^\circ\text{C}$
- $A_{VD}$  . . . 135 dB Min
- CMRR . . . 120 dB Min
- $k_{SVR}$  . . . 110 dB Min
- Single-Supply Operation
- Common-Mode Input Voltage Range Includes the Negative Rail
- No Noise Degradation With External Capacitors Connected to  $V_{DD-}$

## description

The TLC2652 and TLC2652A are high-precision chopper-stabilized operational amplifiers using Texas Instruments Advanced LinCMOS™ process. This process, in conjunction with unique chopper-stabilization circuitry, produces operational amplifiers whose performance matches or exceeds that of similar devices available today.

Chopper-stabilization techniques make possible extremely high dc precision by continuously nulling input offset voltage even during variations in temperature, time, common-mode voltage, and power supply voltage. In addition, low-frequency noise voltage is significantly reduced. This high precision, coupled with the extremely high input impedance of the CMOS input stage, makes the TLC2652 and TLC2652A an ideal choice for low-level signal processing applications such as strain gauges, thermocouples, and other transducer amplifiers. For applications that require extremely low noise and higher usable bandwidth, use the TLC2654 or TLC2654A device, which has a chopping frequency of 10 kHz.

The TLC2652 and TLC2652A input common-mode range includes the negative rail, thereby providing superior performance in either single-supply or split-supply applications, even at power supply voltage levels as low as  $\pm 1.9$  V.

Two external capacitors are required for operation of the device; however, the on-chip chopper-control circuitry is transparent to the user. On devices in the 14-pin and 20-pin packages, the control circuitry is made accessible to allow the user the option of controlling the clock frequency with an external frequency source. In addition, the clock threshold level of the TLC2652 and TLC2652A requires no level shifting when used in the single-supply configuration with a normal CMOS or TTL clock input.

D008, JG, OR P PACKAGE  
(TOP VIEW)

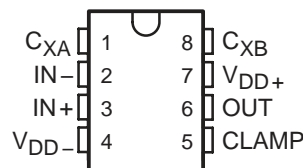

D014, J, OR N PACKAGE  
(TOP VIEW)

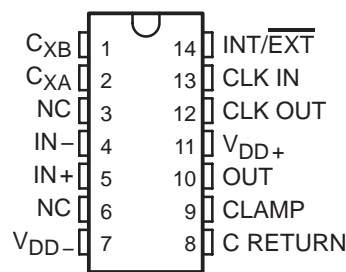

FK PACKAGE  
(TOP VIEW)

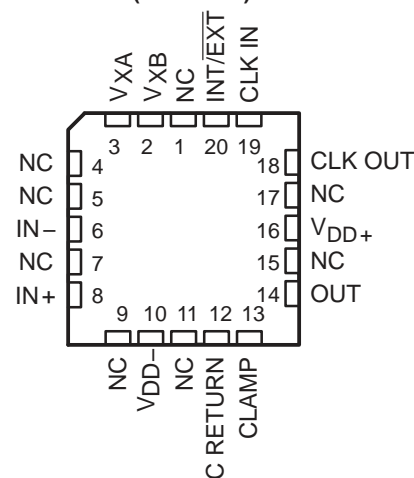

NC – No internal connection



Please be aware that an important notice concerning availability, standard warranty, and use in critical applications of Texas Instruments semiconductor products and disclaimers thereto appears at the end of this data sheet.

Advanced LinCMOS is a trademark of Texas Instruments.

PRODUCTION DATA information is current as of publication date. Products conform to specifications per the terms of Texas Instruments standard warranty. Production processing does not necessarily include testing of all parameters.

 **TEXAS  
INSTRUMENTS**

POST OFFICE BOX 655303 • DALLAS, TEXAS 75265

Copyright © 1988–2005, Texas Instruments Incorporated

On products compliant to MIL-PRF-38535, all parameters are tested unless otherwise noted. On all other products, production processing does not necessarily include testing of all parameters.

# TLC2652, TLC2652A, TLC2652Y

## Advanced LinCMOS™ PRECISION CHOPPER-STABILIZED OPERATIONAL AMPLIFIERS

SLOS019E – SEPTEMBER 1988 – REVISED FEBRUARY 2005

### description (continued)

Innovative circuit techniques are used on the TLC2652 and TLC2652A to allow exceptionally fast overload recovery time. If desired, an output clamp pin is available to reduce the recovery time even further.

The device inputs and output are designed to withstand  $\pm 100$ -mA surge currents without sustaining latch-up. Additionally the TLC2652 and TLC2652A incorporate internal ESD-protection circuits that prevent functional failures at voltages up to 2000 V as tested under MIL-STD-883C, Method 3015.2; however, care should be exercised in handling these devices, as exposure to ESD may result in degradation of the device parametric performance.

The C-suffix devices are characterized for operation from 0°C to 70°C. The I-suffix devices are characterized for operation from -40°C to 85°C. The Q-suffix devices are characterized for operation from -40°C to 125°C. The M-suffix devices are characterized for operation over the full military temperature range of -55°C to 125°C.

### AVAILABLE OPTIONS(1)

T <sub>A</sub>	V <sub>IOmax</sub> AT 25°C	PACKAGED DEVICES							CHIP FORM (Y)
		8 PIN			14 PIN			20 PIN	
		SMALL OUTLINE (D008)	CERAMIC DIP (JG)	PLASTIC DIP (P)	SMALL OUTLINE (D014)	CERAMIC DIP (J)	PLASTIC DIP (N)	CHIP CARRIER (FK)	
0°C to 70°C	1 $\mu$ V 3 $\mu$ V	TLC2652AC-8D TLC2652C-8D	— —	TLC2652ACP TLC2652CP	TLC2652AC-14D TLC2652C-14D	— —	TLC2652ACN TLC2652CN	— —	TLC2652Y
-40°C to 85°C	1 $\mu$ V 3 $\mu$ V	TLC2652AI-8D TLC2652A-8D	— —	TLC2652AIP TLC2652IP	TLC2652AI-14D TLC2652I-14D	— —	TLC2652AIN TLC2652IN	— —	—
-40°C to 125°C	3.5 $\mu$ V	TLC2652Q-8D	—	—	—	—	—	—	—
-55°C to 125°C	3 $\mu$ V 3.5 $\mu$ V	TLC2652AM-8D TLC2652M-8D	TLC2652AMJG TLC2652MJG	TLC2652AMP TLC2652MP	TLC2652AM-14D TLC2652M-14D	TLC2652AMJ TLC2652MJ	TLC2652AMN TLC2652MN	TLC2652AMFK TLC2652MFK	—

The D008 and D014 packages are available taped and reeled. Add R suffix to the device type (e.g., TLC2652AC-8DR). Chips are tested at 25°C. NOTE (1): For the most current package and ordering information, see the Package Option Addendum at the end of this document, or see the TI website at [www.ti.com](http://www.ti.com).

### functional block diagram

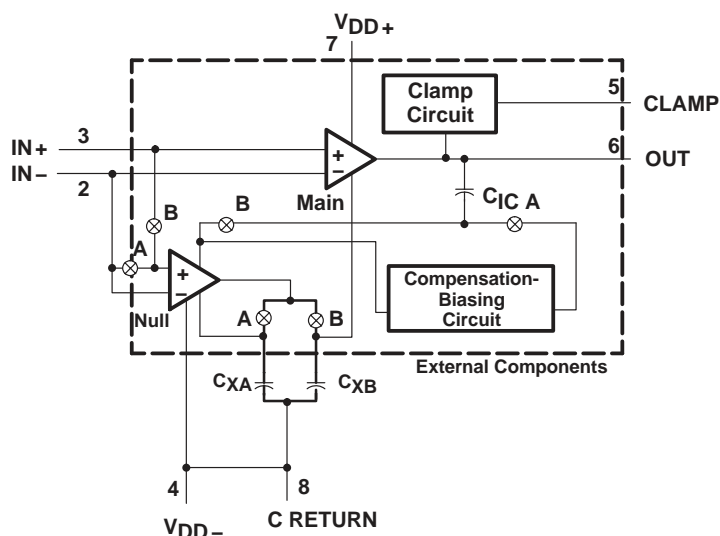

Pin numbers shown are for the D (14 pin), JG, and N packages.

### DISTRIBUTION OF TLC2652 INPUT OFFSET VOLTAGE

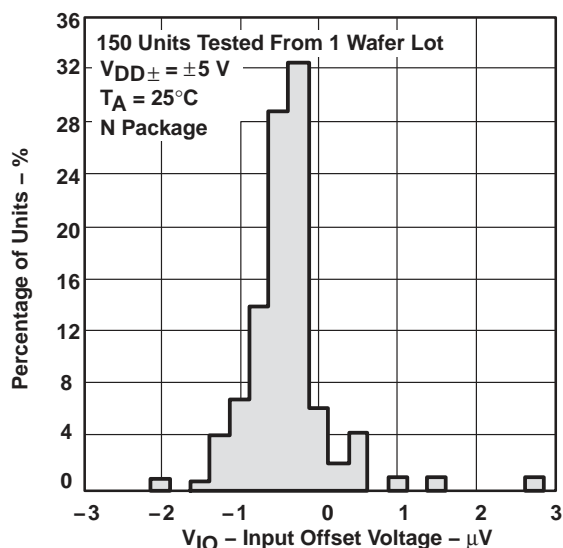

**TLC2652, TLC2652A, TLC2652Y**  
**Advanced LinCMOS™ PRECISION CHOPPER-STABILIZED**  
**OPERATIONAL AMPLIFIERS**

SLOS019E – SEPTEMBER 1988 – REVISED FEBRUARY 2005

**TLC2652Y chip information**

This chip, when properly assembled, displays characteristics similar to the TLC2652C. Thermal compression or ultrasonic bonding may be used on the doped-aluminum bonding pads. Chips may be mounted with conductive epoxy or a gold-silicon preform.

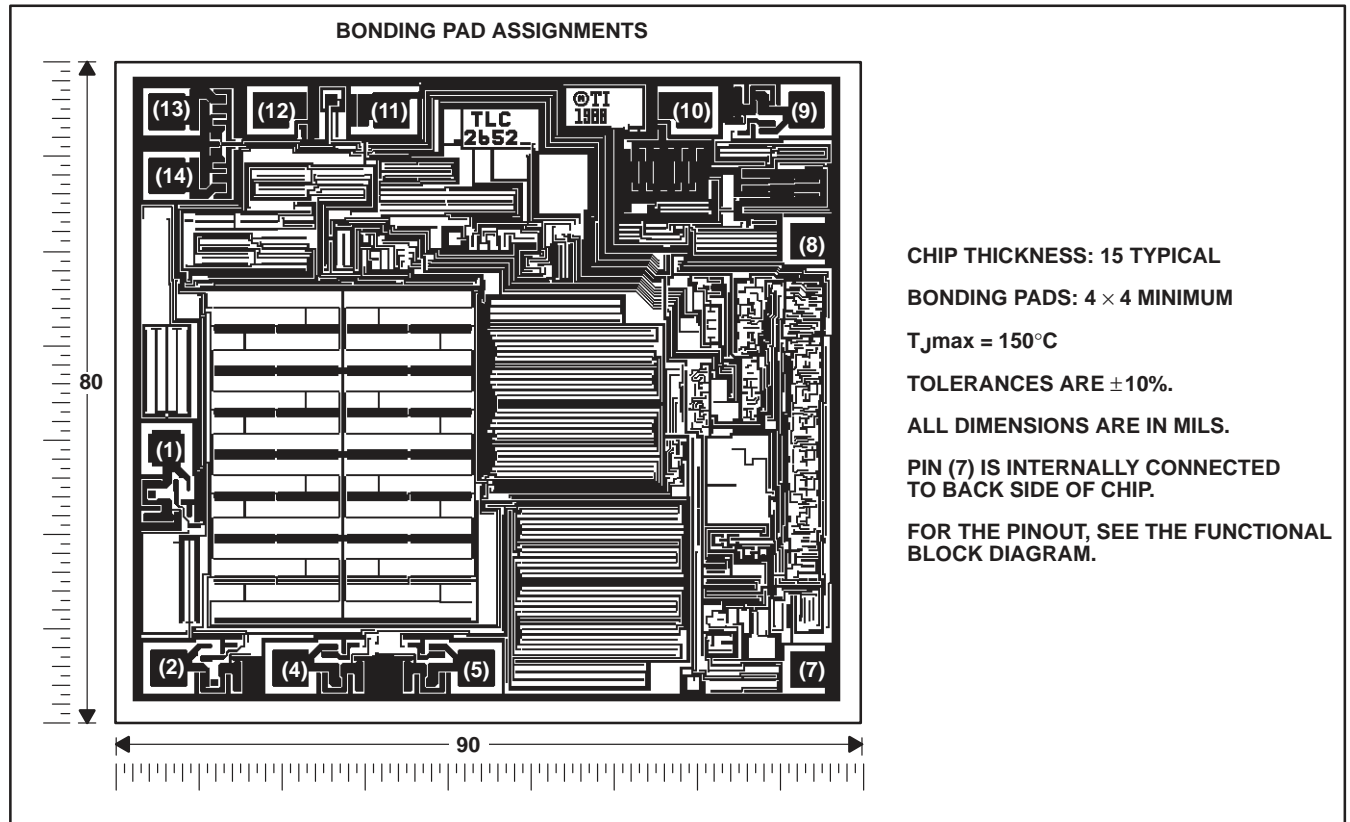

# TLC2652, TLC2652A, TLC2652Y

## Advanced LinCMOS™ PRECISION CHOPPER-STABILIZED OPERATIONAL AMPLIFIERS

SLOS019E – SEPTEMBER 1988 – REVISED FEBRUARY 2005

### absolute maximum ratings over operating free-air temperature range (unless otherwise noted)‡

Supply voltage $V_{DD+}$ (see Note 1)	8 V
Supply voltage $V_{DD-}$ (see Note 1)	-8 V
Differential input voltage, $V_{ID}$ (see Note 2)	$\pm 16$ V
Input voltage, $V_I$ (any input, see Note 1)	$\pm 8$ V
Voltage range on CLK IN and INT/ $\overline{EXT}$	$V_{DD-}$ to $V_{DD+} + 5.2$ V
Input current, $I_I$ (each input)	$\pm 5$ mA
Output current, $I_O$	$\pm 50$ mA
Duration of short-circuit current at (or below) 25°C (see Note 3)	unlimited
Current into CLK IN and INT/ $\overline{EXT}$	$\pm 5$ mA
Continuous total dissipation	See Dissipation Rating Table
Operating free-air temperature range, $T_A$ : C suffix	0°C to 70°C
I suffix	-40°C to 85°C
Q suffix	-40°C to 125°C
M suffix	-55°C to 125°C
Storage temperature range	-65°C to 150°C
Case temperature for 60 seconds: FK package	260°C
Lead temperature 1,6 mm (1/16 inch) from case for 10 seconds: D, N, or P package	260°C
Lead temperature 1,6 mm (1/16 inch) from case for 60 seconds: J or JG package	300°C

† Stresses beyond those listed under “absolute maximum ratings” may cause permanent damage to the device. These are stress ratings only, and functional operation of the device at these or any other conditions beyond those indicated under “recommended operating conditions” is not implied. Exposure to absolute-maximum-rated conditions for extended periods may affect device reliability.

- NOTES: 1. All voltage values, except differential voltages, are with respect to the midpoint between  $V_{DD+}$  and  $V_{DD-}$ .  
 2. Differential voltages are at IN+ with respect to IN-.  
 3. The output may be shorted to either supply. Temperature and/or supply voltages must be limited to ensure that the maximum dissipation rating is not exceeded.

DISSIPATION RATING TABLE

PACKAGE	$T_A \leq 25^\circ\text{C}$	DERATING FACTOR	$T_A = 70^\circ\text{C}$	$T_A = 85^\circ\text{C}$	$T_A = 125^\circ\text{C}$
	POWER RATING	ABOVE $T_A = 25^\circ\text{C}$	POWER RATING	POWER RATING	POWER RATING
D008	725 mW	5.8 mW/°C	464 mW	377 mW	145 mW
D014	950 mW	7.6 mW/°C	608 mW	494 mW	190 mW
FK	1375 mW	11.0 mW/°C	880 mW	715 mW	275 mW
J	1375 mW	11.0 mW/°C	880 mW	715 mW	275 mW
JG	1050 mW	8.4 mW/°C	672 mW	546 mW	210 mW
N	1575 mW	12.6 mW/°C	1008 mW	819 mW	315 mW
P	1000 mW	8.0 mW/°C	640 mW	520 mW	200 mW

### recommended operating conditions

	C SUFFIX		I SUFFIX		Q SUFFIX		M SUFFIX		UNIT
	MIN	MAX	MIN	MAX	MIN	MAX	MIN	MAX	
Supply voltage, $V_{DD\pm}$	$\pm 1.9$	$\pm 8$	$\pm 1.9$	$\pm 8$	$\pm 1.9$	$\pm 8$	$\pm 1.9$	$\pm 8$	V
Common-mode input voltage, $V_{IC}$	$V_{DD-}$	$V_{DD+} - 1.9$	$V_{DD-}$	$V_{DD+} - 1.9$	$V_{DD-}$	$V_{DD+} - 1.9$	$V_{DD-}$	$V_{DD+} - 1.9$	V
Clock input voltage	$V_{DD-}$	$V_{DD-} + 5$	$V_{DD-}$	$V_{DD-} + 5$	$V_{DD-}$	$V_{DD-} + 5$	$V_{DD-}$	$V_{DD-} + 5$	V
Operating free-air temperature, $T_A$	0	70	-40	85	-40	125	-55	125	°C



**TLC2652, TLC2652A, TLC2652Y**  
**Advanced LinCMOS™ PRECISION CHOPPER-STABILIZED**  
**OPERATIONAL AMPLIFIERS**

SLOS019E – SEPTEMBER 1988 – REVISED FEBRUARY 2005

**electrical characteristics at specified free-air temperature,  $V_{DD} \pm = \pm 5$  V (unless otherwise noted)**

PARAMETER	TEST CONDITIONS	$T_A$ †	TLC2652C			TLC2652AC			UNIT	
			MIN	TYP	MAX	MIN	TYP	MAX		
$V_{IO}$ Input offset voltage	$V_{IC} = 0, R_S = 50 \Omega$	25°C	0.6		3	0.5		1	$\mu V$	
		Full range	4.35			2.35				
$\alpha_{VIO}$ Temperature coefficient of input offset voltage		Full range	0.003	0.03		0.003	0.03		$\mu V/^\circ C$	
Input offset voltage long-term drift (see Note 4)		25°C	0.003	0.06		0.003	0.02		$\mu V/mo$	
$I_{IO}$ Input offset current		25°C	2		60	2		60	$pA$	
		Full range	100			100				
$I_{IB}$ Input bias current		25°C	4		60	4		60	$pA$	
		Full range	100			100				
$V_{ICR}$ Common-mode input voltage range		$R_S = 50 \Omega$	Full range	-5 to 3.1		-5 to 3.1				V
$V_{OM+}$ Maximum positive peak output voltage swing		$R_L = 10 k\Omega$ , See Note 5	25°C	4.7	4.8		4.7	4.8		V
	Full range		4.7			4.7				
$V_{OM-}$ Maximum negative peak output voltage swing	$R_L = 10 k\Omega$ , See Note 5	25°C	-4.7	-4.9		-4.7	-4.9		V	
		Full range	-4.7			-4.7				
$A_{VD}$ Large-signal differential voltage amplification	$V_O = \pm 4$ V, $R_L = 10 k\Omega$	25°C	120	150		135	150		dB	
		Full range	120			130				
$f_{ch}$ Internal chopping frequency		25°C	450			450			Hz	
Clamp on-state current	$R_L = 100 k\Omega$	25°C	25			25			$\mu A$	
		Full range	25			25				
Clamp off-state current	$V_O = -4$ V to 4 V	25°C	100			100			$pA$	
		Full range	100			100				
CMRR Common-mode rejection ratio	$V_O = 0, V_{IC} = V_{ICRmin}, R_S = 50 \Omega$	25°C	120	140		120	140		dB	
		Full range	120			120				
$k_{SVR}$ Supply-voltage rejection ratio ( $\Delta V_{DD} / \Delta V_{IO}$ )	$V_{DD} \pm = \pm 1.9$ V to $\pm 8$ V, $V_O = 0, R_S = 50 \Omega$	25°C	110	135		110	135		dB	
		Full range	110			110				
$I_{DD}$ Supply current		25°C	1.5		2.4	1.5		2.4	mA	
		Full range	2.5			2.5				

† Full range is 0° to 70°C.

- NOTES: 4. Typical values are based on the input offset voltage shift observed through 168 hours of operating life test at  $T_A = 150^\circ C$  extrapolated at  $T_A = 25^\circ$  using the Arrhenius equation and assuming an activation energy of 0.96 eV.  
5. Output clamp is not connected.



**TLC2652, TLC2652A, TLC2652Y**  
**Advanced LinCMOS™ PRECISION CHOPPER-STABILIZED**  
**OPERATIONAL AMPLIFIERS**

SLOS019E – SEPTEMBER 1988 – REVISED FEBRUARY 2005

operating characteristics specified free-air temperature,  $V_{DD\pm} = \pm 5\text{ V}$

PARAMETER	TEST CONDITIONS	T <sub>A</sub> †	TLC2652C			TLC2652AC			UNIT
			MIN	TYP	MAX	MIN	TYP	MAX	
SR+ Positive slew rate at unity gain	V <sub>O</sub> = ±2.3 V, R <sub>L</sub> = 10 kΩ, C <sub>L</sub> = 100 pF	25°C	2	2.8		2	2.8		V/μs
		Full range	1.5			1.5			
SR- Negative slew rate at unity gain		25°C	2.3	3.1		2.3	3.1		V/μs
		Full range	1.8			1.8			
V <sub>n</sub> Equivalent input noise voltage (see Note 6)	f = 10 Hz	25°C		94		94	140	nV/√Hz	
	f = 1 kHz	25°C		23		23	35		
V <sub>N(PP)</sub> Peak-to-peak equivalent input noise voltage	f = 0 to 1 Hz	25°C		0.8		0.8		μV	
	f = 0 to 10 Hz	25°C		2.8		2.8			
I <sub>n</sub> Equivalent input noise current	f = 10 kHz	25°C		0.004		0.004		fA/√Hz	
Gain-bandwidth product	f = 10 kHz, R <sub>L</sub> = 10 kΩ, C <sub>L</sub> = 100 pF	25°C		1.9		1.9		MHz	
φ <sub>m</sub> Phase margin at unity gain	R <sub>L</sub> = 10 kΩ, C <sub>L</sub> = 100 pF	25°C		48°		48°			

† Full range is 0° to 70°C.

NOTE 6: This parameter is tested on a sample basis for the TLC2652A. For other test requirements, please contact the factory. This statement has no bearing on testing or nontesting of other parameters.



# TLC2652, TLC2652A, TLC2652Y Advanced LinCMOS™ PRECISION CHOPPER-STABILIZED OPERATIONAL AMPLIFIERS

SLOS019E – SEPTEMBER 1988 – REVISED FEBRUARY 2005

**electrical characteristics at specified free-air temperature,  $V_{DD} \pm = \pm 5$  V (unless otherwise noted)**

PARAMETER	TEST CONDITIONS	$T_A$ †	TLC2652I			TLC2652AI			UNIT
			MIN	TYP	MAX	MIN	TYP	MAX	
$V_{IO}$ Input offset voltage	$V_{IC} = 0, R_S = 50 \Omega$	25°C	0.6	3		0.5	1	$\mu V$	
		Full range			4.95		2.95		
$\alpha_{VIO}$ Temperature coefficient of input offset voltage		Full range	0.003	0.03		0.003	0.03	$\mu V/^\circ C$	
Input offset voltage long-term drift (see Note 4)		25°C	0.003	0.06		0.003	0.02	$\mu V/mo$	
$I_{IO}$ Input offset current		25°C		2	60		2	60	$pA$
		Full range			150			150	
$I_{IB}$ Input bias current	25°C		4	60		4	60	$pA$	
	Full range			150			150		
$V_{ICR}$ Common-mode input voltage range	$R_S = 50 \Omega$	Full range	-5 to 3.1			-5 to 3.1		V	
$V_{OM+}$ Maximum positive peak output voltage swing	$R_L = 10 k\Omega, \text{ See Note 5}$	25°C	4.7	4.8		4.7	4.8	V	
		Full range	4.7			4.7			
$V_{OM-}$ Maximum negative peak output voltage swing	$R_L = 10 k\Omega, \text{ See Note 5}$	25°C	-4.7	-4.9		-4.7	-4.9	V	
		Full range	-4.7			-4.7			
$A_{VD}$ Large-signal differential voltage amplification	$V_O = \pm 4 V, R_L = 10 k\Omega$	25°C	120	150		135	150	dB	
		Full range	120			125			
Internal chopping frequency		25°C		450			450	Hz	
Clamp on-state current	$R_L = 100 k\Omega$	25°C		25			25	$\mu A$	
		Full range		25			25		
Clamp off-state current	$V_O = -4 V \text{ to } 4 V$	25°C					100	$pA$	
		Full range					100		
CMRR Common-mode rejection ratio	$V_O = 0, V_{IC} = V_{ICRmin}, R_S = 50 \Omega$	25°C	120	140		120	140	dB	
		Full range	120			120			
$k_{SVR}$ Supply-voltage rejection ratio ( $\Delta V_{DD} / \Delta V_{IO}$ )	$V_{DD} \pm = \pm 1.9 V \text{ to } \pm 8 V, V_O = 0, R_S = 50 \Omega$	25°C	110	135		110	135	dB	
		Full range	110			110			
$I_{DD}$ Supply current	$V_O = 0, \text{ No load}$	25°C		1.5	2.4		1.5	2.4	mA
		Full range			2.5			2.5	

† Full range is  $-40^\circ$  to  $85^\circ C$ .

- NOTES: 4. Typical values are based on the input offset voltage shift observed through 168 hours of operating life test at  $T_A = 150^\circ C$  extrapolated at  $T_A = 25^\circ$  using the Arrhenius equation and assuming an activation energy of 0.96 eV.  
5. Output clamp is not connected.

**TLC2652, TLC2652A, TLC2652Y**  
**Advanced LinCMOS™ PRECISION CHOPPER-STABILIZED**  
**OPERATIONAL AMPLIFIERS**

SLOS019E – SEPTEMBER 1988 – REVISED FEBRUARY 2005

operating characteristics at specified free-air temperature,  $V_{DD\pm} = \pm 5\text{ V}$

PARAMETER	TEST CONDITIONS	T <sub>A</sub> †	TLC2652I			TLC2652AI			UNIT
			MIN	TYP	MAX	MIN	TYP	MAX	
SR+	Positive slew rate at unity gain	V <sub>O</sub> = ±2.3 V, R <sub>L</sub> = 10 kΩ, C <sub>L</sub> = 100 pF	25°C	2	2.8		2	2.8	V/μs
			Full range	1.4			1.4		
SR–	Negative slew rate at unity gain	V <sub>O</sub> = ±2.3 V, R <sub>L</sub> = 10 kΩ, C <sub>L</sub> = 100 pF	25°C	2.3	3.1		2.3	3.1	V/μs
			Full range	1.7			1.7		
V <sub>n</sub>	Equivalent input noise voltage (see Note 6)	f = 10 Hz	25°C		94		94	140	nV/√Hz
			25°C		23		23	35	
V <sub>N(PP)</sub>	Peak-to-peak equivalent input noise voltage	f = 0 to 1 Hz	25°C		0.8		0.8		μV
			25°C		2.8		2.8		
I <sub>n</sub>	Equivalent input noise current	f = 1 kHz	25°C		0.004		0.004	pA/√Hz	
	Gain-bandwidth product	f = 10 kHz, R <sub>L</sub> = 10 kΩ, C <sub>L</sub> = 100 pF	25°C		1.9		1.9	MHz	
φ <sub>m</sub>	Phase margin at unity gain	R <sub>L</sub> = 10 kΩ, C <sub>L</sub> = 100 pF	25°C		48°		48°		

† Full range is –40° to 85°C.

NOTE 6: This parameter is tested on a sample basis for the TLC2652A. For other test requirements, please contact the factory. This statement has no bearing on testing or nontesting of other parameters.





# TLC2652, TLC2652A, TLC2652Y Advanced LinCMOS™ PRECISION CHOPPER-STABILIZED OPERATIONAL AMPLIFIERS

SLOS019E – SEPTEMBER 1988 – REVISED FEBRUARY 2005

**electrical characteristics at specified free-air temperature,  $V_{DD} \pm \pm 5\text{ V}$  (unless otherwise noted)**

PARAMETER	TEST CONDITIONS	$T_A$ †	TLC2652Q TLC2652M			TLC2652AM			UNIT	
			MIN	TYP	MAX	MIN	TYP	MAX		
$V_{IO}$ Input offset voltage (see Note 7)	$V_{IC} = 0, \quad R_S = 50\ \Omega$	25°C		0.6	3.5		0.5	3	$\mu\text{V}$	
		Full range			10			8		
$\alpha_{VIO}$ Temperature coefficient of input offset voltage		Full range		0.003	0.03*		0.003	0.03*	$\mu\text{V}/^\circ\text{C}$	
Input offset voltage long-term drift (see Note 4)		25°C		0.003	0.06*		0.003	0.02*	$\mu\text{V}/\text{mo}$	
$I_{IO}$ Input offset current		25°C			2	60		2	60	$\text{pA}$
		Full range				500			500	
$I_{IB}$ Input bias current		25°C			4	60		4	60	$\text{pA}$
		Full range				500			500	
$V_{ICR}$ Common-mode input voltage range	$R_S = 50\ \Omega$	Full range		-5 to 3.1			-5 to 3.1		V	
$V_{OM+}$ Maximum positive peak output voltage swing	$R_L = 10\ \text{k}\Omega, \quad \text{See Note 5}$	25°C		4.7	4.8		4.7	4.8	V	
		Full range		4.7			4.7			
$V_{OM-}$ Maximum negative peak output voltage swing	$R_L = 10\ \text{k}\Omega, \quad \text{See Note 5}$	25°C		-4.7	-4.9		-4.7	-4.9	V	
		Full range		-4.7			-4.7			
$A_{VD}$ Large-signal differential voltage amplification	$V_O = \pm 4\ \text{V}, \quad R_L = 10\ \text{k}\Omega$	25°C		120	150		135	150	dB	
		Full range		120			120			
$f_{ch}$ Internal chopping frequency		25°C		450			450	Hz		
Clamp on-state current	$V_O = -5\ \text{V to } 5\ \text{V}$	25°C		25			25		$\mu\text{A}$	
		Full range		25			25			
Clamp off-state current	$R_L = 100\ \text{k}\Omega$	25°C			100			100	$\text{pA}$	
		Full range			500			500		
CMRR Common-mode rejection ratio	$V_O = 0, \quad V_{IC} = V_{ICR\text{min}},$ $R_S = 50\ \Omega$	25°C		120	140		120	140	dB	
		Full range		120			120			
$k_{SVR}$ Supply-voltage rejection ratio ( $\Delta V_{DD\pm}/\Delta V_{IO}$ )	$V_{DD\pm} = \pm 1.9\ \text{V to } \pm 8\ \text{V},$ $V_O = 0, \quad R_S = 50\ \Omega$	25°C		110	135		110	135	dB	
		Full range		110			110			
$I_{DD}$ Supply current	$V_O = 0, \quad \text{No load}$	25°C		1.5	2.4		1.5	2.4	mA	
		Full range			2.5			2.5		

\* On products compliant to MIL-PRF-38535, this parameter is not production tested.

† Full range is  $-40^\circ$  to  $125^\circ\text{C}$  for Q suffix,  $-55^\circ$  to  $125^\circ\text{C}$  for M suffix.

NOTES: 4. Typical values are based on the input offset voltage shift observed through 168 hours of operating life test at  $T_A = 150^\circ\text{C}$  extrapolated at  $T_A = 25^\circ$  using the Arrhenius equation and assuming an activation energy of 0.96 eV.

5. Output clamp is not connected.

7. This parameter is not production tested. Thermocouple effects preclude measurement of the actual  $V_{IO}$  of these devices in high speed automated testing.  $V_{IO}$  is measured to a limit determined by the test equipment capability at the temperature extremes. The test ensures that the stabilization circuitry is performing properly.



**TLC2652, TLC2652A, TLC2652Y**  
**Advanced LinCMOS™ PRECISION CHOPPER-STABILIZED**  
**OPERATIONAL AMPLIFIERS**

SLOS019E – SEPTEMBER 1988 – REVISED FEBRUARY 2005

operating characteristics at specified free-air temperature,  $V_{DD\pm} = \pm 5\text{ V}$

PARAMETER	TEST CONDITIONS	$T_A$ †	TLC2652Q TLC2652M TLC2652AM			UNIT
			MIN	TYP	MAX	
SR+ Positive slew rate at unity gain	$V_O = \pm 2.3\text{ V}$ , $R_L = 10\text{ k}\Omega$ , $C_L = 100\text{ pF}$	25°C	2	2.8	V/ $\mu$ s	
		Full range	1.3			
SR– Negative slew rate at unity gain		25°C	2.3	3.1	V/ $\mu$ s	
		Full range	1.6			
$V_n$ Equivalent input noise voltage	f = 10 Hz	25°C	94		nV/ $\sqrt{\text{Hz}}$	
	f = 1 kHz	25°C	23			
$V_{N(PP)}$ Peak-to-peak equivalent input noise voltage	f = 0 to 1 Hz	25°C	0.8		$\mu$ V	
	f = 0 to 10 Hz	25°C	2.8			
$I_n$ Equivalent input noise current	f = 1 kHz	25°C	0.004		pA/ $\sqrt{\text{Hz}}$	
Gain-bandwidth product	f = 10 kHz, $R_L = 10\text{ k}\Omega$ , $C_L = 100\text{ pF}$	25°C	1.9		MHz	
$\phi_m$ Phase margin at unity gain	$R_L = 10\text{ k}\Omega$ , $C_L = 100\text{ pF}$	25°C	48°			

† Full range is –40° to 125°C for the Q suffix, –55° to 125°C for the M suffix.



# TLC2652, TLC2652A, TLC2652Y Advanced LinCMOS™ PRECISION CHOPPER-STABILIZED OPERATIONAL AMPLIFIERS

SLOS019E – SEPTEMBER 1988 – REVISED FEBRUARY 2005

**electrical characteristics at  $V_{DD\pm} = \pm 5\text{ V}$ ,  $T_A = 25^\circ\text{C}$  (unless otherwise noted)**

PARAMETER		TEST CONDITIONS	TLC2652Y			UNIT
			MIN	TYP	MAX	
$V_{IO}$	Input offset voltage	$V_{IC} = 0$ , $R_S = 50\ \Omega$		0.6	3	$\mu\text{V}$
	Input offset voltage long-term drift (see Note 4)			0.003	0.006	$\mu\text{V}/\text{mo}$
$I_{IO}$	Input offset current			2	60	$\text{pA}$
$I_{IB}$	Input bias current			4	60	$\text{pA}$
$V_{ICR}$	Common-mode input voltage range	$R_S = 50\ \Omega$	-5 to 3.1			V
$V_{OM+}$	Maximum positive peak output voltage swing	$R_L = 10\ \text{k}\Omega$ , See Note 5	4.7	4.8		V
$V_{OM-}$	Maximum negative peak output voltage swing	$R_L = 10\ \text{k}\Omega$ , See Note 5	-4.7	-4.9		V
$A_{VD}$	Large-signal differential voltage amplification	$V_O = \pm 4\ \text{V}$ , $R_L = 10\ \text{k}\Omega$	120	150		dB
$f_{ch}$	Internal chopping frequency			450		Hz
	Clamp on-state current	$R_L = 100\ \text{k}\Omega$	25			$\mu\text{A}$
	Clamp off-state current	$V_O = -4\ \text{V}$ to $4\ \text{V}$			100	$\text{pA}$
CMRR	Common-mode rejection ratio	$V_O = 0$ , $R_S = 50\ \Omega$ , $V_{IC} = V_{ICR\text{min}}$	120	140		dB
$k_{SVR}$	Supply-voltage rejection ratio ( $\Delta V_{DD\pm}/\Delta V_{IO}$ )	$V_{DD\pm} = \pm 1.9\ \text{V}$ to $\pm 8\ \text{V}$ , $R_S = 50\ \Omega$ , $V_O = 0$	110	135		dB
$I_{DD}$	Supply current	$V_O = 0$ , No load		1.5	2.4	$\text{mA}$

- NOTES: 4. Typical values are based on the input offset voltage shift observed through 168 hours of operating life test at  $T_A = 150^\circ\text{C}$  extrapolated at  $T_A = 25^\circ$  using the Arrhenius equation and assuming an activation energy of 0.96 eV.  
5. Output clamp is not connected.

**operating characteristics at  $V_{DD\pm} = \pm 5\text{ V}$ ,  $T_A = 25^\circ\text{C}$**

PARAMETER		TEST CONDITIONS	TLC2652Y			UNIT
			MIN	TYP	MAX	
$SR+$	Positive slew rate at unity gain	$V_O = \pm 2.3\ \text{V}$ , $R_L = 10\ \text{k}\Omega$ , $C_L = 100\ \text{pF}$	2	2.8		$\text{V}/\mu\text{s}$
$SR-$	Negative slew rate at unity gain		2.3	3.1		$\text{V}/\mu\text{s}$
$V_n$	Equivalent input noise voltage	$f = 10\ \text{Hz}$		94		$\text{nV}/\sqrt{\text{Hz}}$
		$f = 1\ \text{kHz}$		23		
$V_{N(PP)}$	Peak-to-peak equivalent input noise voltage	$f = 0$ to $1\ \text{Hz}$		0.8		$\mu\text{V}$
		$f = 0$ to $10\ \text{Hz}$		2.8		
$I_n$	Equivalent input noise current	$f = 1\ \text{kHz}$				$\text{pA}/\sqrt{\text{Hz}}$
	Gain-bandwidth product	$f = 10\ \text{kHz}$ , $R_L = 10\ \text{k}\Omega$ , $C_L = 100\ \text{pF}$		1.9		MHz
$\phi_m$	Phase margin at unity gain	$R_L = 10\ \text{k}\Omega$ , $C_L = 100\ \text{pF}$		48°		



**TLC2652, TLC2652A, TLC2652Y**  
**Advanced LinCMOS™ PRECISION CHOPPER-STABILIZED**  
**OPERATIONAL AMPLIFIERS**

SLOS019E – SEPTEMBER 1988 – REVISED FEBRUARY 2005

**TYPICAL CHARACTERISTICS**

**Table of Graphs**

		<b>FIGURE</b>	
$V_{IO}$	Normalized input offset voltage	vs Chopping frequency	1
$I_{IB}$	Input bias current	vs Common-mode input voltage	2
		vs Chopping frequency	3
		vs Free-air temperature	4
$I_{IO}$	Input offset current	vs Chopping frequency	5
		vs Free-air temperature	6
	Clamp current	vs Output voltage	7
$V_{(OPP)}$	Maximum peak-to-peak output voltage	vs Frequency	8
$V_{OM}$	Maximum peak output voltage	vs Output current	9, 10
		vs Free-air temperature	11, 12
$A_{VD}$	Large-signal differential voltage amplification	vs Frequency	13
		vs Free-air temperature	14
	Chopping frequency	vs Supply voltage	15
		vs Free-air temperature	16
$I_{DD}$	Supply current	vs Supply voltage	17
		vs Free-air temperature	18
$I_{OS}$	Short-circuit output current	vs Supply voltage	19
		vs Free-air temperature	20
SR	Slew rate	vs Supply voltage	21
		vs Free-air temperature	22
	Voltage-follower pulse response	Small-signal	23
		Large-signal	24
$V_{N(PP)}$	Peak-to-peak equivalent input noise voltage	vs Chopping frequency	25, 26
$V_n$	Equivalent input noise voltage	vs Frequency	27
	Gain-bandwidth product	vs Supply voltage	28
		vs Free-air temperature	29
$\phi_m$	Phase margin	vs Supply voltage	30
		vs Free-air temperature	31
		vs Load capacitance	32
	Phase shift	vs Frequency	13



TYPICAL CHARACTERISTICS†

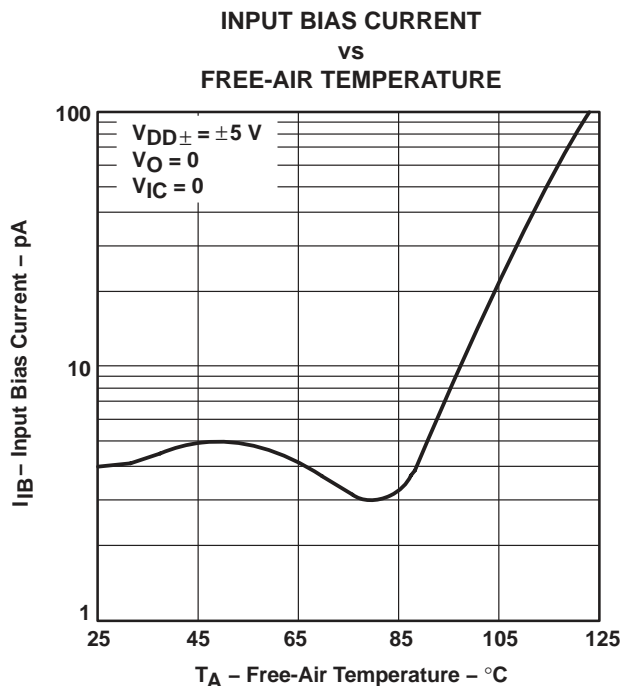
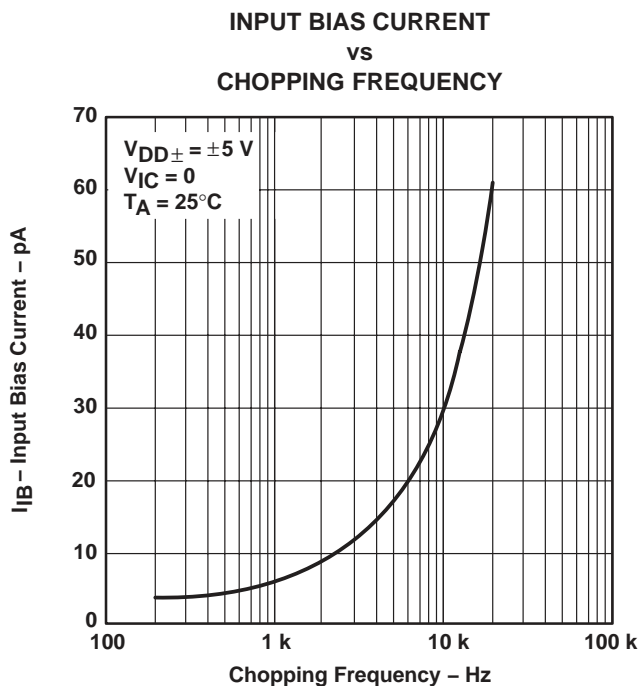
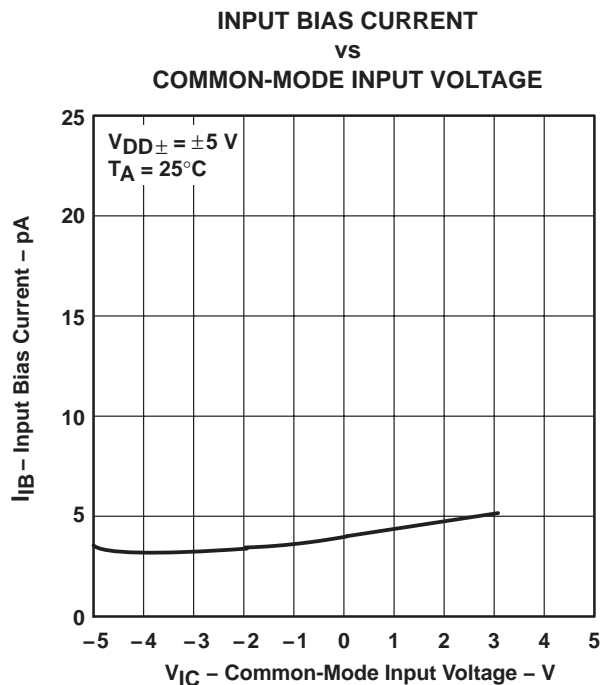
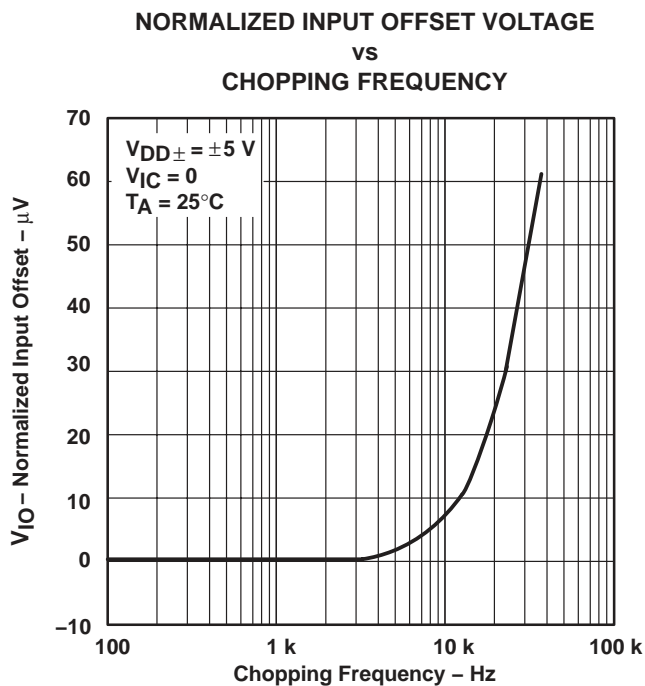

† Data at high and low temperatures are applicable only within the rated operating free-air temperature ranges of the various devices.

**TLC2652, TLC2652A, TLC2652Y**  
**Advanced LinCMOS™ PRECISION CHOPPER-STABILIZED**  
**OPERATIONAL AMPLIFIERS**

SLOS019E – SEPTEMBER 1988 – REVISED FEBRUARY 2005

**TYPICAL CHARACTERISTICS†**

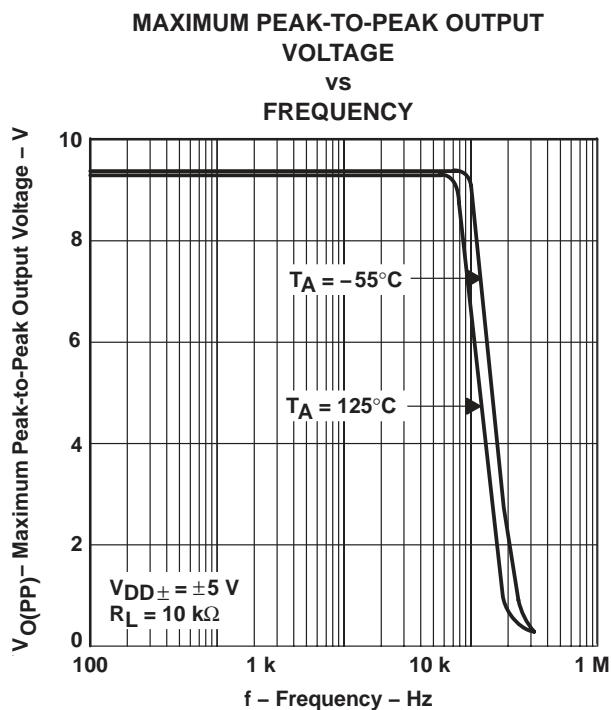
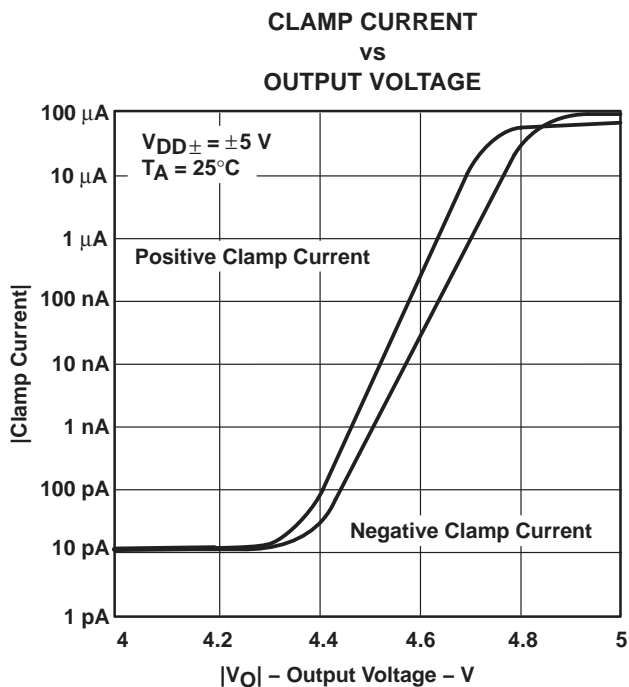
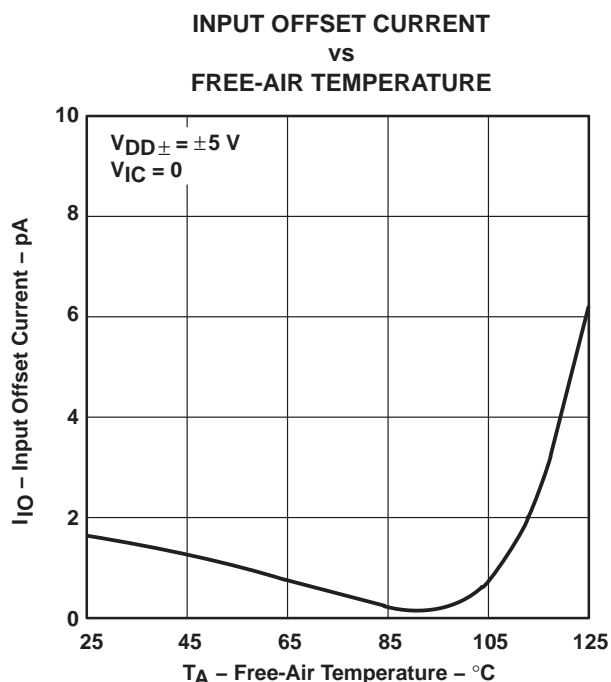
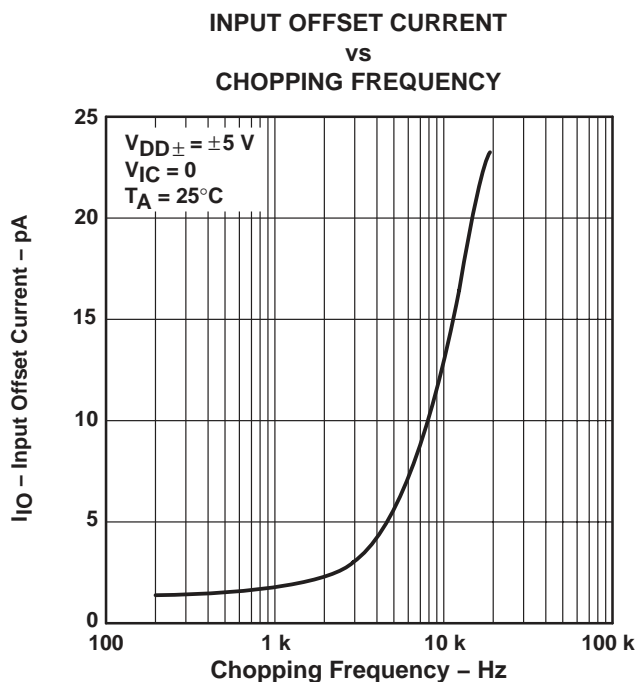

† Data at high and low temperatures are applicable only within the rated operating free-air temperature ranges of the various devices.

TYPICAL CHARACTERISTICS†

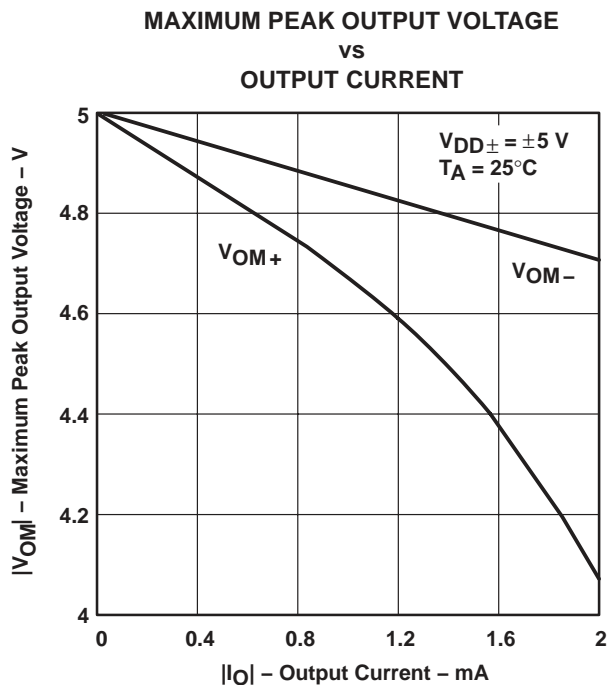

Figure 9

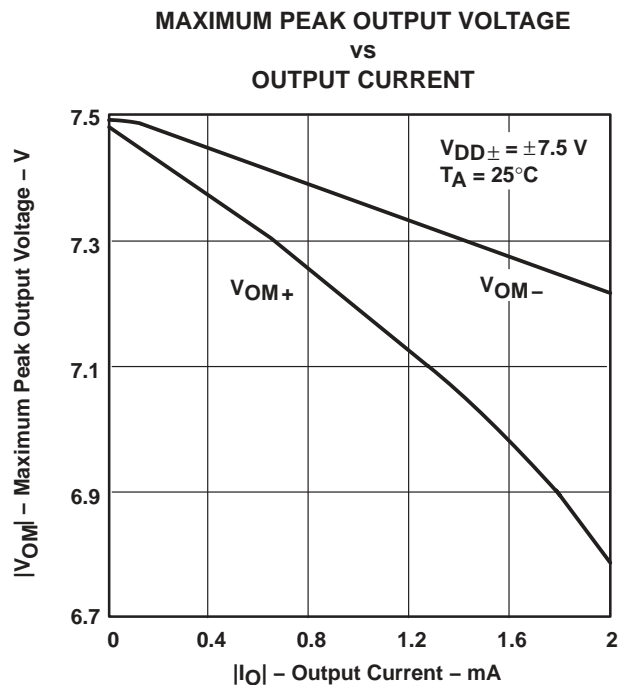

Figure 10

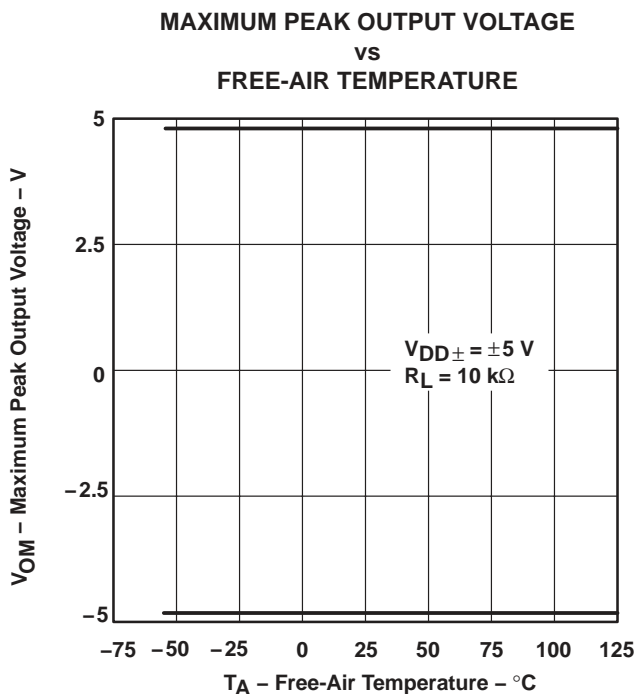

Figure 11

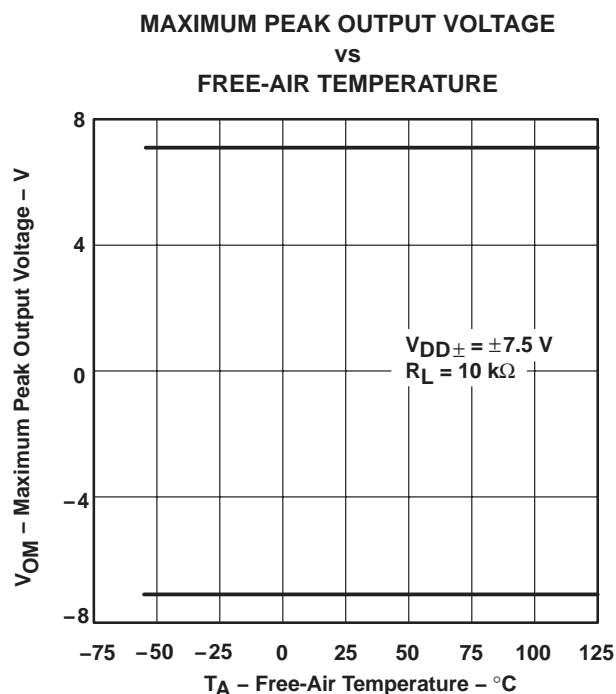

Figure 12

† Data at high and low temperatures are applicable only within the rated operating free-air temperature ranges of the various devices.

**TLC2652, TLC2652A, TLC2652Y**  
**Advanced LinCMOS™ PRECISION CHOPPER-STABILIZED**  
**OPERATIONAL AMPLIFIERS**

SLOS019E – SEPTEMBER 1988 – REVISED FEBRUARY 2005

**TYPICAL CHARACTERISTICS†**

**LARGE-SIGNAL DIFFERENTIAL VOLTAGE AMPLIFICATION AND PHASE SHIFT**

**vs**  
**FREQUENCY**

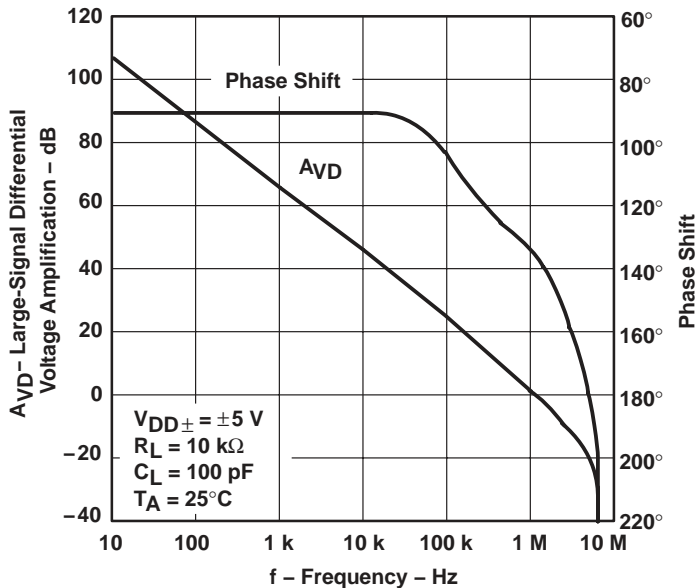

**Figure 13**

**LARGE-SIGNAL DIFFERENTIAL VOLTAGE AMPLIFICATION**

**vs**  
**FREE-AIR TEMPERATURE**

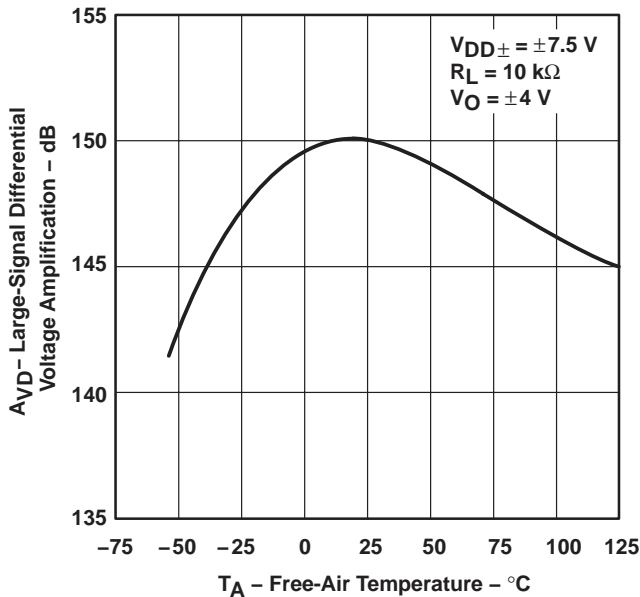

**Figure 14**

† Data at high and low temperatures are applicable only within the rated operating free-air temperature ranges of the various devices.





TYPICAL CHARACTERISTICS†

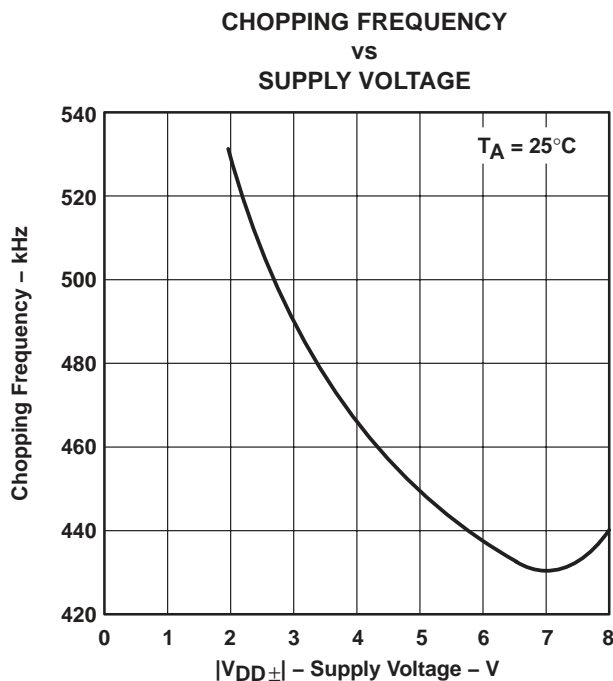

Figure 15

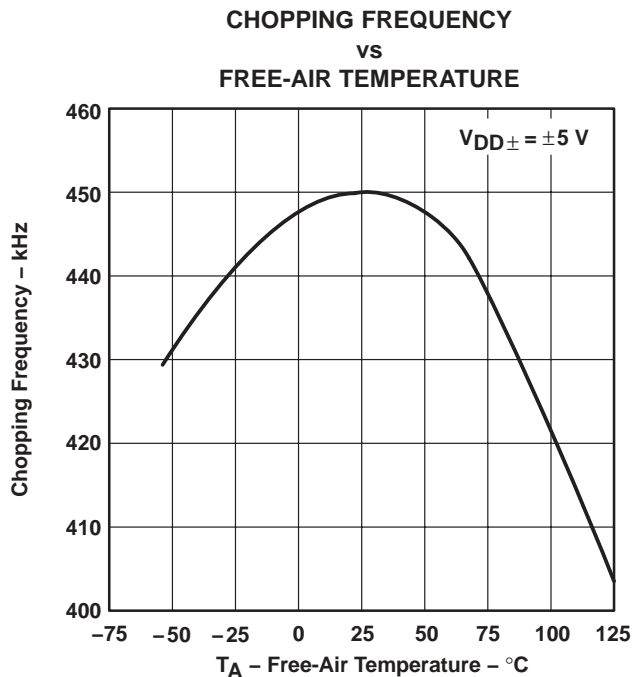

Figure 16

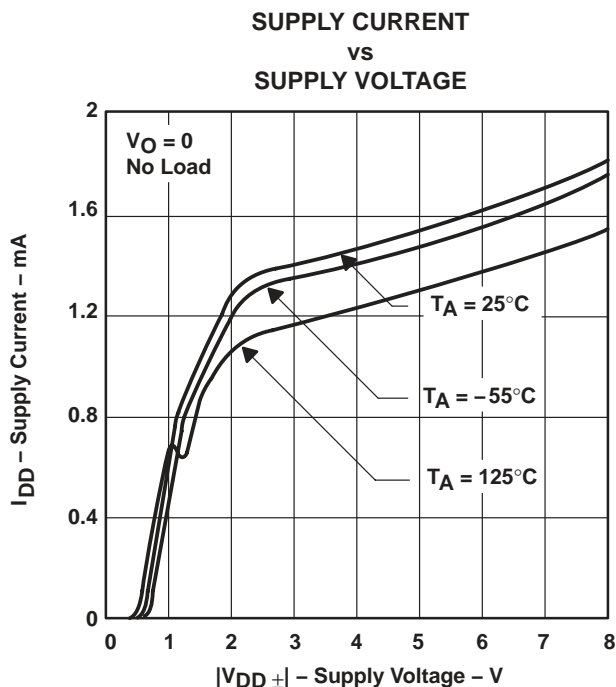

Figure 17

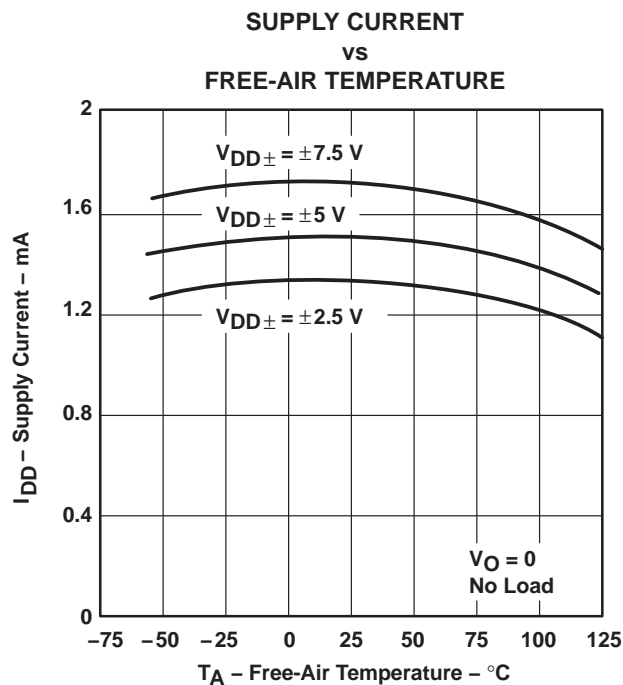

Figure 18

† Data at high and low temperatures are applicable only within the rated operating free-air temperature ranges of the various devices.

**TLC2652, TLC2652A, TLC2652Y**  
**Advanced LinCMOS™ PRECISION CHOPPER-STABILIZED**  
**OPERATIONAL AMPLIFIERS**

SLOS019E – SEPTEMBER 1988 – REVISED FEBRUARY 2005

**TYPICAL CHARACTERISTICS†**

**SHORT-CIRCUIT OUTPUT CURRENT**  
**vs**  
**SUPPLY VOLTAGE**

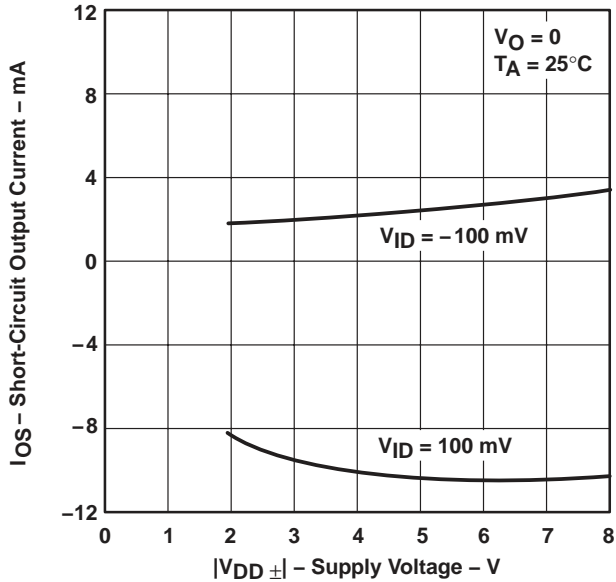

**Figure 19**

**SHORT-CIRCUIT OUTPUT CURRENT**  
**vs**  
**FREE-AIR TEMPERATURE**

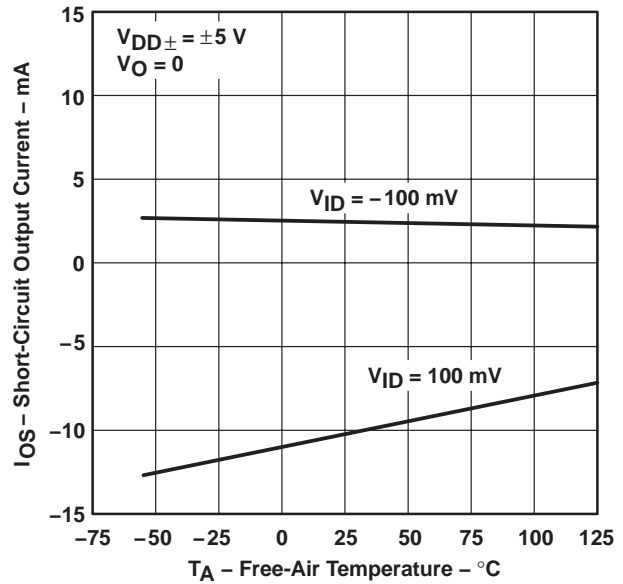

**Figure 20**

**SLEW RATE**  
**vs**  
**SUPPLY VOLTAGE**

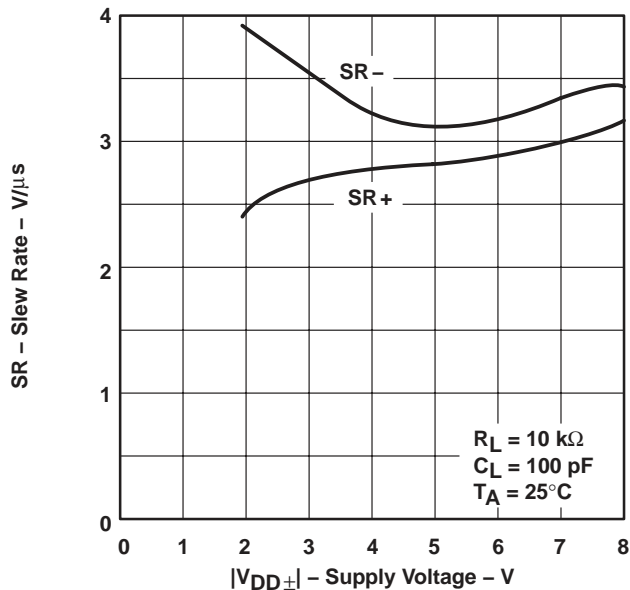

**Figure 21**

**SLEW RATE**  
**vs**  
**FREE-AIR TEMPERATURE**

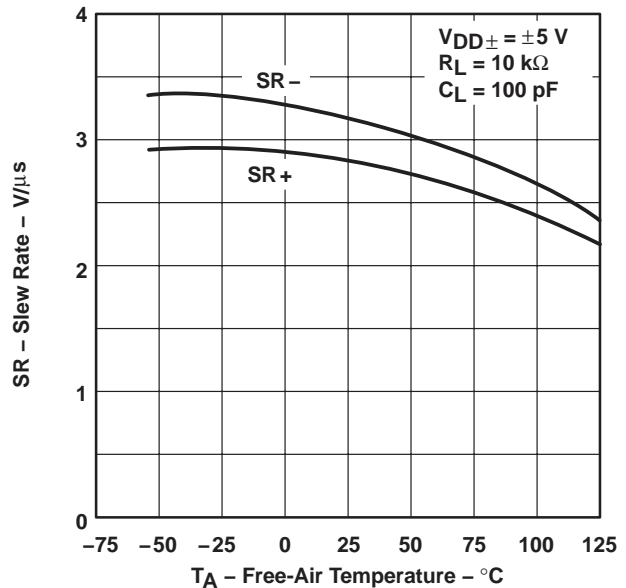

**Figure 22**

† Data at high and low temperatures are applicable only within the rated operating free-air temperature ranges of the various devices.



TYPICAL CHARACTERISTICS

VOLTAGE-FOLLOWER  
 SMALL-SIGNAL  
 PULSE RESPONSE

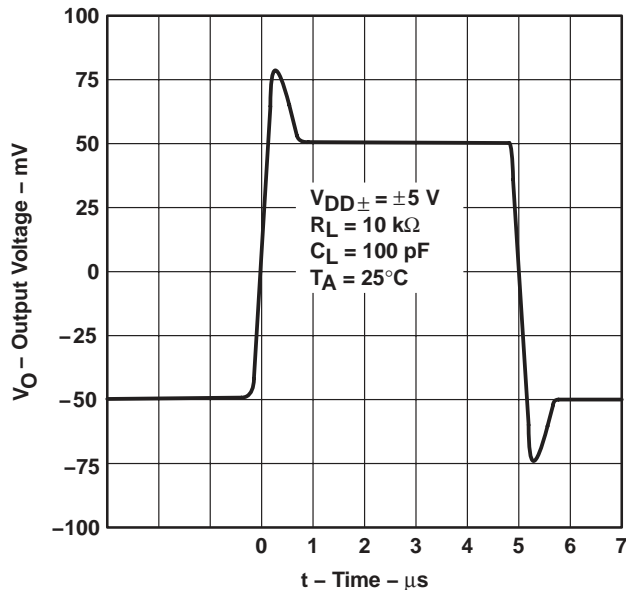

Figure 23

VOLTAGE-FOLLOWER  
 LARGE-SIGNAL  
 PULSE RESPONSE

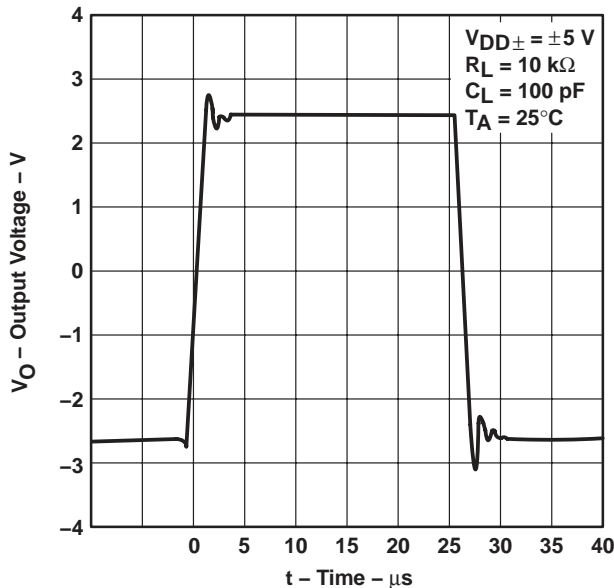

Figure 24

PEAK-TO-PEAK INPUT NOISE VOLTAGE  
 vs  
 CHOPPING FREQUENCY

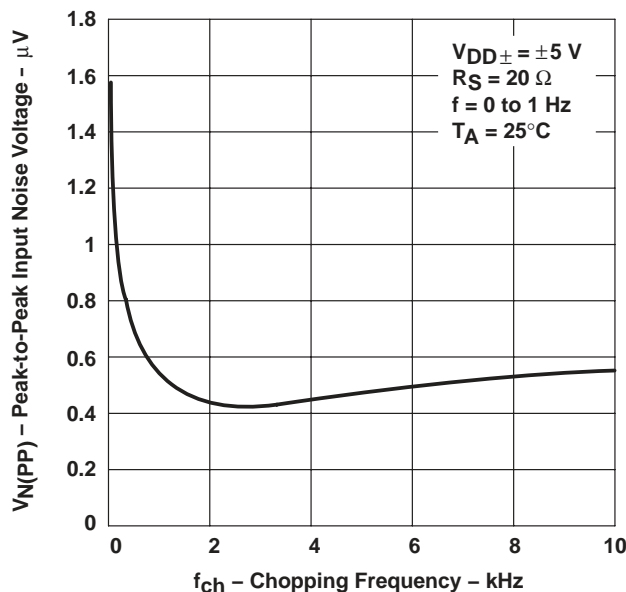

Figure 25

PEAK-TO-PEAK INPUT NOISE VOLTAGE  
 vs  
 CHOPPING FREQUENCY

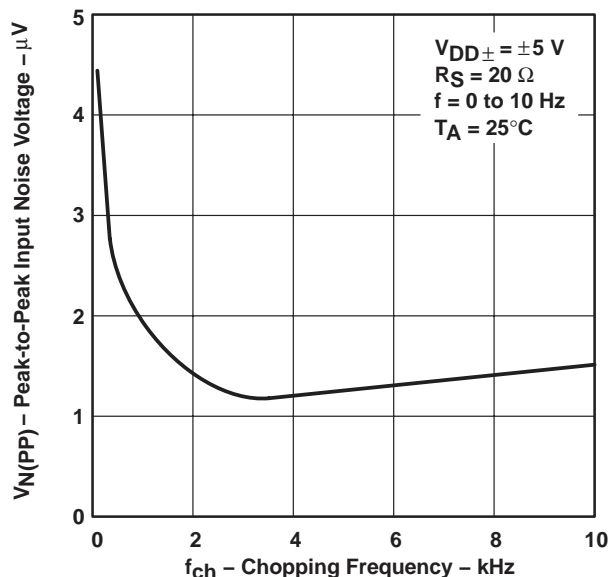

Figure 26

# TLC2652, TLC2652A, TLC2652Y

## Advanced LinCMOS™ PRECISION CHOPPER-STABILIZED OPERATIONAL AMPLIFIERS

SLOS019E – SEPTEMBER 1988 – REVISED FEBRUARY 2005

### TYPICAL CHARACTERISTICS†

**EQUIVALENT INPUT NOISE VOLTAGE  
vs  
FREQUENCY**

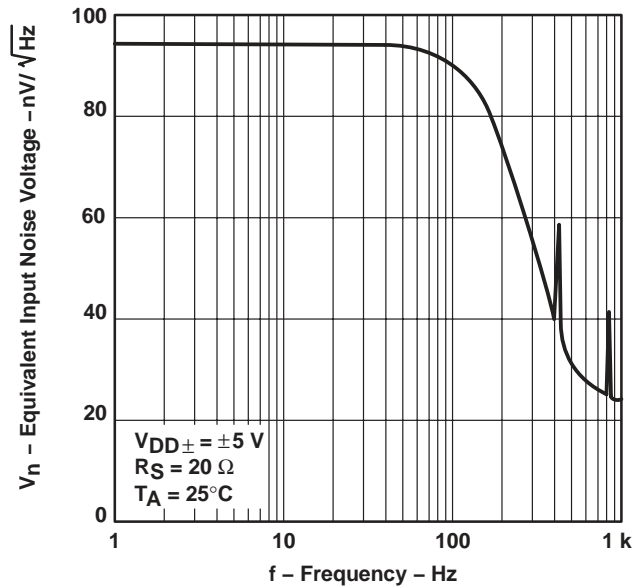

Figure 27

**GAIN-BANDWIDTH PRODUCT  
vs  
SUPPLY VOLTAGE**

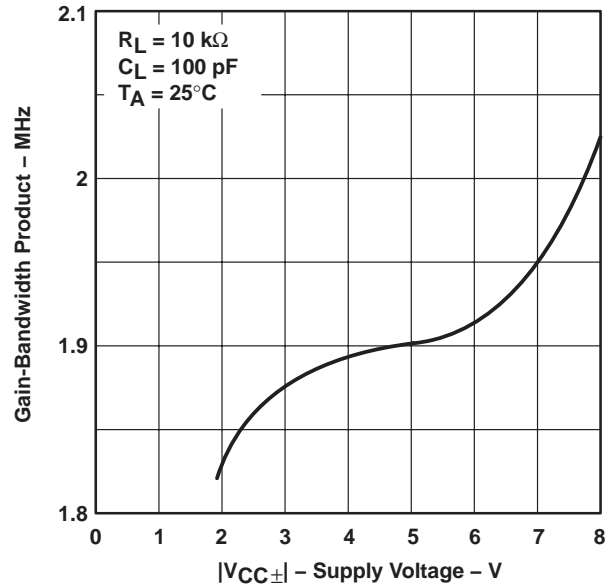

Figure 28

**GAIN-BANDWIDTH PRODUCT  
vs  
FREE-AIR TEMPERATURE**

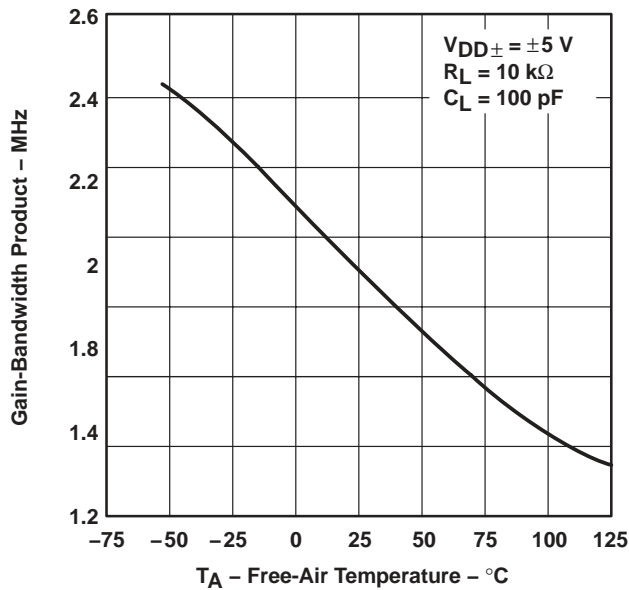

Figure 29

**PHASE MARGIN  
vs  
SUPPLY VOLTAGE**

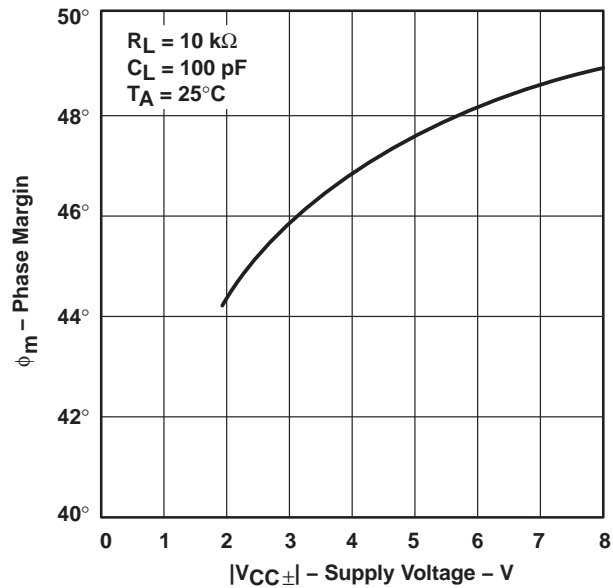
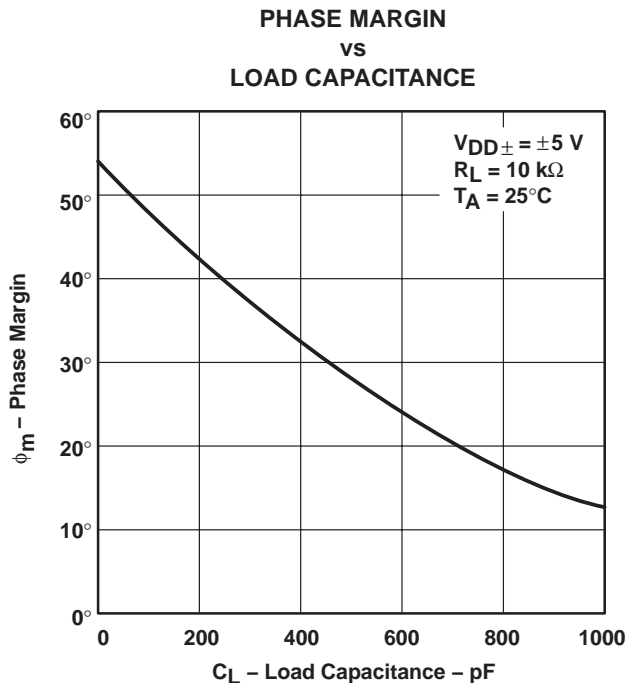
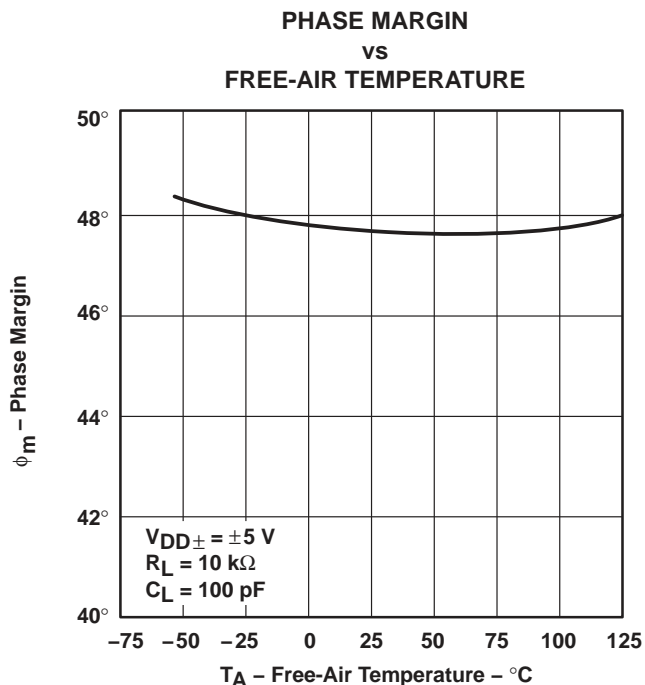

Figure 30

† Data at high and low temperatures are applicable only within the rated operating free-air temperature ranges of the various devices.

**TYPICAL CHARACTERISTICS†**



† Data at high and low temperatures are applicable only within the rated operating free-air temperature ranges of the various devices.

**APPLICATION INFORMATION**

**capacitor selection and placement**

The two important factors to consider when selecting external capacitors  $C_{XA}$  and  $C_{XB}$  are leakage and dielectric absorption. Both factors can cause system degradation, negating the performance advantages realized by using the TLC2652.

Degradation from capacitor leakage becomes more apparent with the increasing temperatures. Low-leakage capacitors and standoffs are recommended for operation at  $T_A = 125^\circ\text{C}$ . In addition, guard bands are recommended around the capacitor connections on both sides of the printed circuit board to alleviate problems caused by surface leakage on circuit boards.

Capacitors with high dielectric absorption tend to take several seconds to settle upon application of power, which directly affects input offset voltage. In applications where fast settling of input offset voltage is needed, it is recommended that high-quality film capacitors, such as mylar, polystyrene, or polypropylene, be used. In other applications, however, a ceramic or other low-grade capacitor can suffice.

Unlike many choppers available today, the TLC2652 is designed to function with values of  $C_{XA}$  and  $C_{XB}$  in the range of  $0.1 \mu\text{F}$  to  $1 \mu\text{F}$  without degradation to input offset voltage or input noise voltage. These capacitors should be located as close as possible to the  $C_{XA}$  and  $C_{XB}$  pins and returned to either  $V_{DD-}$  or C RETURN. On many choppers, connecting these capacitors to  $V_{DD-}$  causes degradation in noise performance. This problem is eliminated on the TLC2652.

**APPLICATION INFORMATION**

**internal/external clock**

The TLC2652 has an internal clock that sets the chopping frequency to a nominal value of 450 Hz. On 8-pin packages, the chopping frequency can only be controlled by the internal clock; however, on all 14-pin packages and the 20-pin FK package, the device chopping frequency can be set by the internal clock or controlled externally by use of the INT/EXT and CLK IN pins. To use the internal 450-Hz clock, no connection is necessary. If external clocking is desired, connect INT/EXT to  $V_{DD-}$  and the external clock to CLK IN. The external clock trip point is 2.5 V above the negative rail; however, CLK IN can be driven from the negative rail to 5 V above the negative rail. If this level is exceeded, damage could occur to the device unless the current into CLK IN is limited to  $\pm 5$  mA. When operating in the single-supply configuration, this feature allows the TLC2652 to be driven directly by 5-V TTL and CMOS logic. A divide-by-two frequency divider interfaces with CLK IN and sets the clock chopping frequency. The duty cycle of the external clock is not critical but should be kept between 30% and 60%.

**overload recovery/output clamp**

When large differential input voltage conditions are applied to the TLC2652, the nulling loop attempts to prevent the output from saturating by driving  $C_{XA}$  and  $C_{XB}$  to internally-clamped voltage levels. Once the overdrive condition is removed, a period of time is required to allow the built-up charge to dissipate. This time period is defined as overload recovery time (see Figure 33). Typical overload recovery time for the TLC2652 is significantly faster than competitive products; however, if required, this time can be reduced further by use of internal clamp circuitry accessible through CLAMP if required.

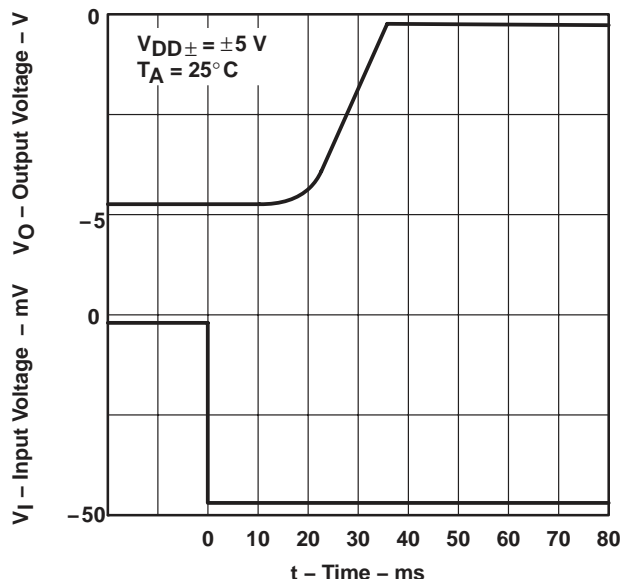

**Figure 33. Overload Recovery**

The clamp is a switch that is automatically activated when the output is approximately 1 V from either supply rail. When connected to the inverting input (in parallel with the closed-loop feedback resistor), the closed-loop gain is reduced, and the TLC2652 output is prevented from going into saturation. Since the output must source or sink current through the switch (see Figure 7), the maximum output voltage swing is slightly reduced.

**thermoelectric effects**

To take advantage of the extremely low offset voltage drift of the TLC2652, care must be taken to compensate for the thermoelectric effects present when two dissimilar metals are brought into contact with each other (such as device leads being soldered to a printed circuit board). Dissimilar metal junctions can produce thermoelectric voltages in the range of several microvolts per degree Celsius (orders of magnitude greater than the  $0.01\text{-}\mu\text{V}/^\circ\text{C}$  typical of the TLC2652).

To help minimize thermoelectric effects, careful attention should be paid to component selection and circuit-board layout. Avoid the use of nonsoldered connections (such as sockets, relays, switches, etc.) in the input signal path. Cancel thermoelectric effects by duplicating the number of components and junctions in each device input. The use of low-thermoelectric-coefficient components, such as wire-wound resistors, is also beneficial.

## APPLICATION INFORMATION

### latch-up avoidance

Because CMOS devices are susceptible to latch-up due to their inherent parasitic thyristors, the TLC2652 inputs and output are designed to withstand –100-mA surge currents without sustaining latch-up; however, techniques to reduce the chance of latch-up should be used whenever possible. Internal protection diodes should not, by design, be forward biased. Applied input and output voltages should not exceed the supply voltage by more than 300 mV. Care should be exercised when using capacitive coupling on pulse generators. Supply transients should be shunted by the use of decoupling capacitors (0.1  $\mu$ F typical) located across the supply rails as close to the device as possible.

The current path established if latch-up occurs is usually between the supply rails and is limited only by the impedance of the power supply and the forward resistance of the parasitic thyristor. The chance of latch-up occurring increases with increasing temperature and supply voltage.

### electrostatic discharge protection

The TLC2652 incorporates internal ESD-protection circuits that prevent functional failures at voltages at or below 2000 V. Care should be exercised in handling these devices, as exposure to ESD may result in degradation of the device parametric performance.

### theory of operation

Chopper-stabilized operational amplifiers offer the best dc performance of any monolithic operational amplifier. This superior performance is the result of using two operational amplifiers, a main amplifier and a nulling amplifier, plus oscillator-controlled logic and two external capacitors to create a system that behaves as a single amplifier. With this approach, the TLC2652 achieves submicrovolt input offset voltage, submicrovolt noise voltage, and offset voltage variations with temperature in the nV/°C range.

The TLC2652 on-chip control logic produces two dominant clock phases: a nulling phase and an amplifying phase. The term chopper-stabilized derives from the process of switching between these two clock phases. Figure 34 shows a simplified block diagram of the TLC2652. Switches A and B are make-before-break types.

During the nulling phase, switch A is closed shorting the nulling amplifier inputs together and allowing the nulling amplifier to reduce its own input offset voltage by feeding its output signal back to an inverting input node. Simultaneously, external capacitor  $C_{XA}$  stores the nulling potential to allow the offset voltage of the amplifier to remain nulled during the amplifying phase.

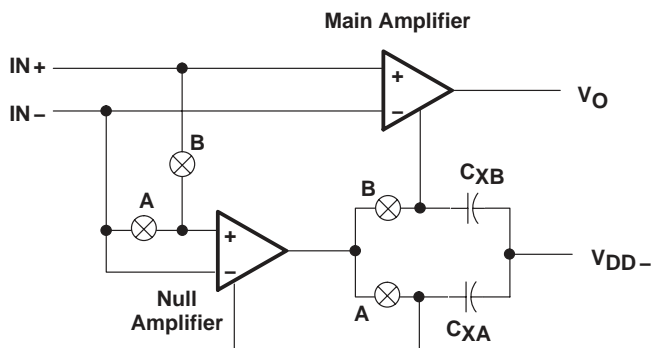

**Figure 34. TLC2652 Simplified Block Diagram**

# TLC2652, TLC2652A, TLC2652Y

## Advanced LinCMOS™ PRECISION CHOPPER-STABILIZED OPERATIONAL AMPLIFIERS

SLOS019E – SEPTEMBER 1988 – REVISED FEBRUARY 2005

---

### APPLICATION INFORMATION

#### theory of operation (continued)

During the amplifying phase, switch B is closed connecting the output of the nulling amplifier to a noninverting input of the main amplifier. In this configuration, the input offset voltage of the main amplifier is nulled. Also, external capacitor  $C_{XB}$  stores the nulling potential to allow the offset voltage of the main amplifier to remain nulled during the next nulling phase.

This continuous chopping process allows offset voltage nulling during variations in time and temperature over the common-mode input voltage range and power supply range. In addition, because the low-frequency signal path is through both the null and main amplifiers, extremely high gain is achieved.

The low-frequency noise of a chopper amplifier depends on the magnitude of the component noise prior to chopping and the capability of the circuit to reduce this noise while chopping. The use of the Advanced LinCMOS process, with its low-noise analog MOS transistors and patent-pending input stage design, significantly reduces the input noise voltage.

The primary source of nonideal operation in chopper-stabilized amplifiers is error charge from the switches. As charge imbalance accumulates on critical nodes, input offset voltage can increase, especially with increasing chopping frequency. This problem has been significantly reduced in the TLC2652 by use of a patent-pending compensation circuit and the Advanced LinCMOS process.

The TLC2652 incorporates a feed-forward design that ensures continuous frequency response. Essentially, the gain magnitude of the nulling amplifier and compensation network crosses unity at the break frequency of the main amplifier. As a result, the high-frequency response of the system is the same as the frequency response of the main amplifier. This approach also ensures that the slewing characteristics remain the same during both the nulling and amplifying phases.





**PACKAGING INFORMATION**

Orderable Device	Status (1)	Package Type	Package Drawing	Pins	Package Qty	Eco Plan (2)	Lead/Ball Finish (6)	MSL Peak Temp (3)	Op Temp (°C)	Device Marking (4/5)	Samples
5962-9089501M2A	NRND	LCCC	FK	20	1	TBD	POST-PLATE	N / A for Pkg Type	-55 to 125	5962- 9089501M2A TLC2652MFKB	
5962-9089501MCA	NRND	CDIP	J	14	1	TBD	A42	N / A for Pkg Type	-55 to 125	5962-9089501MC A TLC2652MJB	
5962-9089501MPA	ACTIVE	CDIP	JG	8	1	TBD	A42	N / A for Pkg Type	-55 to 125	9089501MPA TLC2652M	<a href="#">Samples</a>
5962-9089503M2A	NRND	LCCC	FK	20	1	TBD	POST-PLATE	N / A for Pkg Type	-55 to 125	5962- 9089503M2A TLC2652AMFKB	
5962-9089503MCA	ACTIVE	CDIP	J	14	1	TBD	A42	N / A for Pkg Type	-55 to 125	5962-9089503MC A TLC2652AMJB	<a href="#">Samples</a>
5962-9089503MPA	ACTIVE	CDIP	JG	8	1	TBD	A42	N / A for Pkg Type	-55 to 125	9089503MPA TLC2652AM	<a href="#">Samples</a>
TLC2652AC-14D	ACTIVE	SOIC	D	14	50	Green (RoHS & no Sb/Br)	CU NIPDAU	Level-1-260C-UNLIM		2652AC	<a href="#">Samples</a>
TLC2652AC-8D	ACTIVE	SOIC	D	8	75	Green (RoHS & no Sb/Br)	CU NIPDAU	Level-1-260C-UNLIM		2652AC	<a href="#">Samples</a>
TLC2652AC-8DG4	ACTIVE	SOIC	D	8	75	Green (RoHS & no Sb/Br)	CU NIPDAU	Level-1-260C-UNLIM		2652AC	<a href="#">Samples</a>
TLC2652AC-8DR	OBSOLETE	SOIC	D	0		TBD	Call TI	Call TI			
TLC2652ACN	ACTIVE	PDIP	N	14	25	Pb-Free (RoHS)	CU NIPDAU	N / A for Pkg Type		TLC2652ACN	<a href="#">Samples</a>
TLC2652ACP	ACTIVE	PDIP	P	8	50	Pb-Free (RoHS)	CU NIPDAU	N / A for Pkg Type		TLC2652AC	<a href="#">Samples</a>
TLC2652ACPE4	ACTIVE	PDIP	P	8	50	Pb-Free (RoHS)	CU NIPDAU	N / A for Pkg Type		TLC2652AC	<a href="#">Samples</a>
TLC2652AI-14D	ACTIVE	SOIC	D	14	50	Green (RoHS & no Sb/Br)	CU NIPDAU	Level-1-260C-UNLIM		2652AI	<a href="#">Samples</a>
TLC2652AI-8D	ACTIVE	SOIC	D	8	75	Green (RoHS & no Sb/Br)	CU NIPDAU	Level-1-260C-UNLIM		2652AI	<a href="#">Samples</a>
TLC2652AI-8DG4	ACTIVE	SOIC	D	8	75	Green (RoHS & no Sb/Br)	CU NIPDAU	Level-1-260C-UNLIM		2652AI	<a href="#">Samples</a>

Orderable Device	Status (1)	Package Type	Package Drawing	Pins	Package Qty	Eco Plan (2)	Lead/Ball Finish (6)	MSL Peak Temp (3)	Op Temp (°C)	Device Marking (4/5)	Samples
TLC2652AI-8DR	ACTIVE	SOIC	D	8	2500	Green (RoHS & no Sb/Br)	CU NIPDAU	Level-1-260C-UNLIM		2652AI	<a href="#">Samples</a>
TLC2652AI-8DRG4	ACTIVE	SOIC	D	8	2500	Green (RoHS & no Sb/Br)	CU NIPDAU	Level-1-260C-UNLIM		2652AI	<a href="#">Samples</a>
TLC2652AIN	ACTIVE	PDIP	N	14	25	Pb-Free (RoHS)	CU NIPDAU	N / A for Pkg Type		TLC2652AIN	<a href="#">Samples</a>
TLC2652AIP	ACTIVE	PDIP	P	8	50	Pb-Free (RoHS)	CU NIPDAU	N / A for Pkg Type		TLC2652AI	<a href="#">Samples</a>
TLC2652AIPE4	ACTIVE	PDIP	P	8	50	Pb-Free (RoHS)	CU NIPDAU	N / A for Pkg Type		TLC2652AI	<a href="#">Samples</a>
TLC2652AMFKB	NRND	LCCC	FK	20	1	TBD	POST-PLATE	N / A for Pkg Type	-55 to 125	5962-9089503M2A TLC2652AMFKB	
TLC2652AMJB	ACTIVE	CDIP	J	14	1	TBD	A42	N / A for Pkg Type	-55 to 125	5962-9089503MC A TLC2652AMJB	<a href="#">Samples</a>
TLC2652AMJG	ACTIVE	CDIP	JG	8	1	TBD	A42	N / A for Pkg Type	-55 to 125	TLC2652 AMJG	<a href="#">Samples</a>
TLC2652AMJGB	ACTIVE	CDIP	JG	8	1	TBD	A42	N / A for Pkg Type	-55 to 125	9089503MPA TLC2652AM	<a href="#">Samples</a>
TLC2652C-14D	OBSOLETE	SOIC	D	14		TBD	Call TI	Call TI			
TLC2652C-8D	ACTIVE	SOIC	D	8	75	Green (RoHS & no Sb/Br)	CU NIPDAU	Level-1-260C-UNLIM		2652C	<a href="#">Samples</a>
TLC2652C-8DG4	ACTIVE	SOIC	D	8		TBD	Call TI	Call TI			<a href="#">Samples</a>
TLC2652C-8DR	ACTIVE	SOIC	D	8	2500	Green (RoHS & no Sb/Br)	CU NIPDAU	Level-1-260C-UNLIM		2652C	<a href="#">Samples</a>
TLC2652C-8DRG4	ACTIVE	SOIC	D	8	2500	Green (RoHS & no Sb/Br)	CU NIPDAU	Level-1-260C-UNLIM		2652C	<a href="#">Samples</a>
TLC2652CN	ACTIVE	PDIP	N	14	25	Pb-Free (RoHS)	CU NIPDAU	N / A for Pkg Type		TLC2652CN	<a href="#">Samples</a>
TLC2652CP	ACTIVE	PDIP	P	8	50	Pb-Free (RoHS)	CU NIPDAU	N / A for Pkg Type		TLC2652CP	<a href="#">Samples</a>
TLC2652I-8D	ACTIVE	SOIC	D	8	75	Green (RoHS & no Sb/Br)	CU NIPDAU	Level-1-260C-UNLIM		2652I	<a href="#">Samples</a>
TLC2652I-8DG4	ACTIVE	SOIC	D	8	75	Green (RoHS & no Sb/Br)	CU NIPDAU	Level-1-260C-UNLIM		2652I	<a href="#">Samples</a>

Orderable Device	Status (1)	Package Type	Package Drawing	Pins	Package Qty	Eco Plan (2)	Lead/Ball Finish (6)	MSL Peak Temp (3)	Op Temp (°C)	Device Marking (4/5)	Samples
TLC2652I-8DR	ACTIVE	SOIC	D	8	2500	Green (RoHS & no Sb/Br)	CU NIPDAU	Level-1-260C-UNLIM		2652I	<a href="#">Samples</a>
TLC2652IP	ACTIVE	PDIP	P	8	50	Pb-Free (RoHS)	CU NIPDAU	N / A for Pkg Type		TLC2652IP	<a href="#">Samples</a>
TLC2652M-8DG4	ACTIVE	SOIC	D	8	1000	Green (RoHS & no Sb/Br)	CU NIPDAU	Level-1-260C-UNLIM		T2652M	<a href="#">Samples</a>
TLC2652MFKB	NRND	LCCC	FK	20	1	TBD	POST-PLATE	N / A for Pkg Type	-55 to 125	5962-9089501M2A TLC2652MFKB	
TLC2652MJG	ACTIVE	CDIP	JG	8	1	TBD	A42	N / A for Pkg Type	-55 to 125	TLC2652MJG	<a href="#">Samples</a>
TLC2652MJGB	ACTIVE	CDIP	JG	8	1	TBD	A42	N / A for Pkg Type	-55 to 125	9089501MPA TLC2652M	<a href="#">Samples</a>
TLC2652Q-8D	ACTIVE	SOIC	D	8	75	Green (RoHS & no Sb/Br)	CU NIPDAU	Level-1-260C-UNLIM	-40 to 125	T2652Q	<a href="#">Samples</a>
TLC2652Q-8DG4	ACTIVE	SOIC	D	8	75	Green (RoHS & no Sb/Br)	CU NIPDAU	Level-1-260C-UNLIM		T2652Q	<a href="#">Samples</a>

(1) The marketing status values are defined as follows:

**ACTIVE:** Product device recommended for new designs.

**LIFEBUY:** TI has announced that the device will be discontinued, and a lifetime-buy period is in effect.

**NRND:** Not recommended for new designs. Device is in production to support existing customers, but TI does not recommend using this part in a new design.

**PREVIEW:** Device has been announced but is not in production. Samples may or may not be available.

**OBSELETE:** TI has discontinued the production of the device.

(2) Eco Plan - The planned eco-friendly classification: Pb-Free (RoHS), Pb-Free (RoHS Exempt), or Green (RoHS & no Sb/Br) - please check <http://www.ti.com/productcontent> for the latest availability information and additional product content details.

**TBD:** The Pb-Free/Green conversion plan has not been defined.

**Pb-Free (RoHS):** TI's terms "Lead-Free" or "Pb-Free" mean semiconductor products that are compatible with the current RoHS requirements for all 6 substances, including the requirement that lead not exceed 0.1% by weight in homogeneous materials. Where designed to be soldered at high temperatures, TI Pb-Free products are suitable for use in specified lead-free processes.

**Pb-Free (RoHS Exempt):** This component has a RoHS exemption for either 1) lead-based flip-chip solder bumps used between the die and package, or 2) lead-based die adhesive used between the die and leadframe. The component is otherwise considered Pb-Free (RoHS compatible) as defined above.

**Green (RoHS & no Sb/Br):** TI defines "Green" to mean Pb-Free (RoHS compatible), and free of Bromine (Br) and Antimony (Sb) based flame retardants (Br or Sb do not exceed 0.1% by weight in homogeneous material)

(3) MSL, Peak Temp. - The Moisture Sensitivity Level rating according to the JEDEC industry standard classifications, and peak solder temperature.

(4) There may be additional marking, which relates to the logo, the lot trace code information, or the environmental category on the device.

<sup>(5)</sup> Multiple Device Markings will be inside parentheses. Only one Device Marking contained in parentheses and separated by a "~" will appear on a device. If a line is indented then it is a continuation of the previous line and the two combined represent the entire Device Marking for that device.

<sup>(6)</sup> Lead/Ball Finish - Orderable Devices may have multiple material finish options. Finish options are separated by a vertical ruled line. Lead/Ball Finish values may wrap to two lines if the finish value exceeds the maximum column width.

**Important Information and Disclaimer:** The information provided on this page represents TI's knowledge and belief as of the date that it is provided. TI bases its knowledge and belief on information provided by third parties, and makes no representation or warranty as to the accuracy of such information. Efforts are underway to better integrate information from third parties. TI has taken and continues to take reasonable steps to provide representative and accurate information but may not have conducted destructive testing or chemical analysis on incoming materials and chemicals. TI and TI suppliers consider certain information to be proprietary, and thus CAS numbers and other limited information may not be available for release.

In no event shall TI's liability arising out of such information exceed the total purchase price of the TI part(s) at issue in this document sold by TI to Customer on an annual basis.

**OTHER QUALIFIED VERSIONS OF TLC2652, TLC2652A, TLC2652AM, TLC2652M :**

- Catalog: [TLC2652A](#), [TLC2652](#)
- Military: [TLC2652M](#), [TLC2652AM](#)

NOTE: Qualified Version Definitions:

- Catalog - TI's standard catalog product
- Military - QML certified for Military and Defense Applications

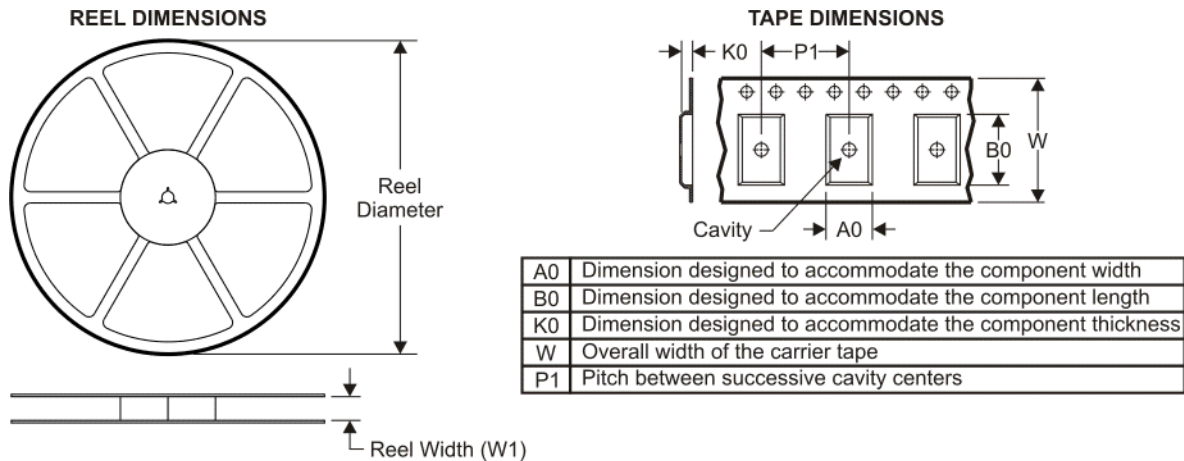
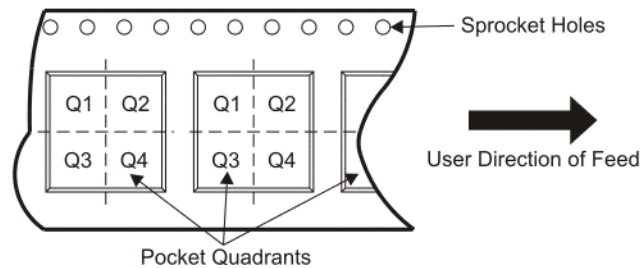
**TAPE AND REEL INFORMATION**

**QUADRANT ASSIGNMENTS FOR PIN 1 ORIENTATION IN TAPE**

\*All dimensions are nominal

Device	Package Type	Package Drawing	Pins	SPQ	Reel Diameter (mm)	Reel Width W1 (mm)	A0 (mm)	B0 (mm)	K0 (mm)	P1 (mm)	W (mm)	Pin1 Quadrant
TLC2652AI-8DR	SOIC	D	8	2500	330.0	12.4	6.4	5.2	2.1	8.0	12.0	Q1
TLC2652C-8DR	SOIC	D	8	2500	330.0	12.4	6.4	5.2	2.1	8.0	12.0	Q1
TLC2652I-8DR	SOIC	D	8	2500	330.0	12.4	6.4	5.2	2.1	8.0	12.0	Q1

**TAPE AND REEL BOX DIMENSIONS**

\*All dimensions are nominal

Device	Package Type	Package Drawing	Pins	SPQ	Length (mm)	Width (mm)	Height (mm)
TLC2652AI-8DR	SOIC	D	8	2500	340.5	338.1	20.6
TLC2652C-8DR	SOIC	D	8	2500	340.5	338.1	20.6
TLC2652I-8DR	SOIC	D	8	2500	340.5	338.1	20.6

JG (R-GDIP-T8)

CERAMIC DUAL-IN-LINE

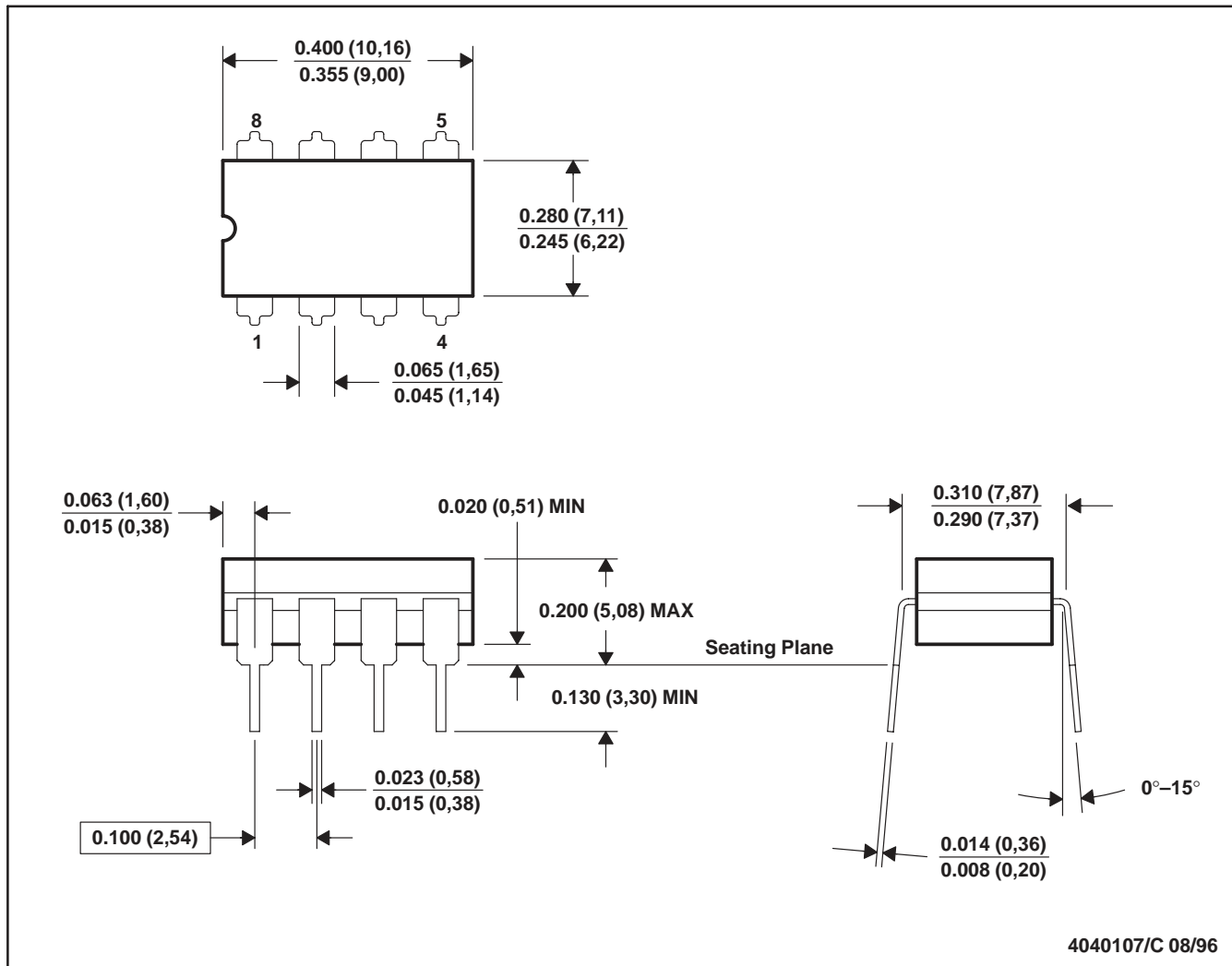

- NOTES: A. All linear dimensions are in inches (millimeters).  
 B. This drawing is subject to change without notice.  
 C. This package can be hermetically sealed with a ceramic lid using glass frit.  
 D. Index point is provided on cap for terminal identification.  
 E. Falls within MIL STD 1835 GDIP1-T8

J (R-GDIP-T\*\*)

14 LEADS SHOWN

CERAMIC DUAL IN-LINE PACKAGE

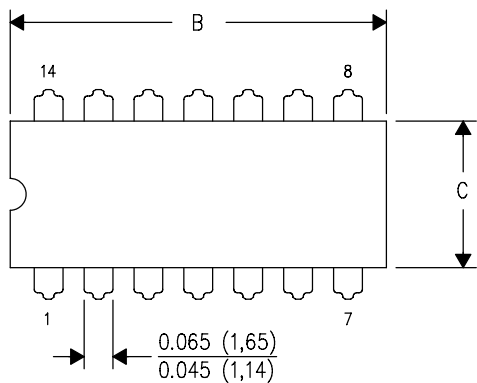

DIM \ PINS **	14	16	18	20
A	0.300 (7,62) BSC	0.300 (7,62) BSC	0.300 (7,62) BSC	0.300 (7,62) BSC
B MAX	0.785 (19,94)	.840 (21,34)	0.960 (24,38)	1.060 (26,92)
B MIN	—	—	—	—
C MAX	0.300 (7,62)	0.300 (7,62)	0.310 (7,87)	0.300 (7,62)
C MIN	0.245 (6,22)	0.245 (6,22)	0.220 (5,59)	0.245 (6,22)

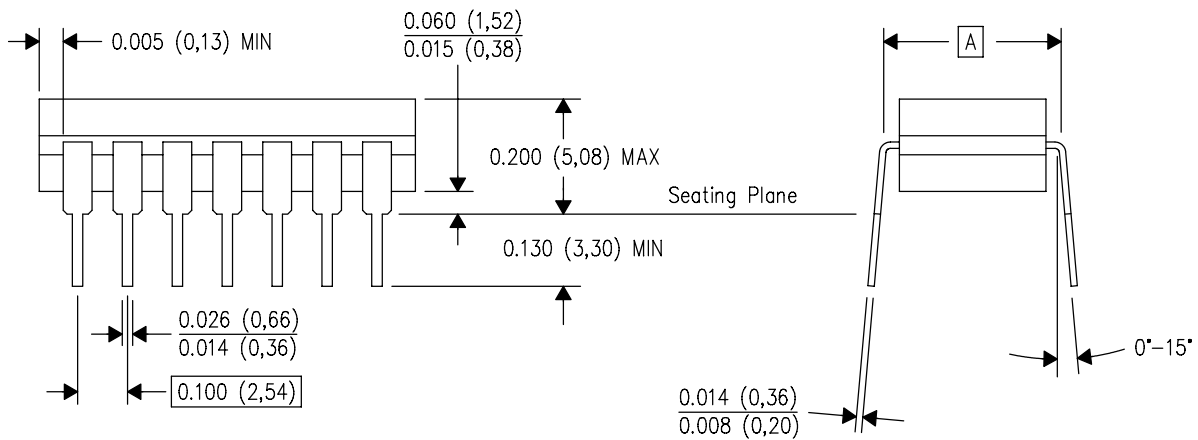

4040083/F 03/03

- NOTES:
- A. All linear dimensions are in inches (millimeters).
  - B. This drawing is subject to change without notice.
  - C. This package is hermetically sealed with a ceramic lid using glass frit.
  - D. Index point is provided on cap for terminal identification only on press ceramic glass frit seal only.
  - E. Falls within MIL STD 1835 GDIP1-T14, GDIP1-T16, GDIP1-T18 and GDIP1-T20.



FK (S-CQCC-N\*\*)

LEADLESS CERAMIC CHIP CARRIER

28 TERMINAL SHOWN

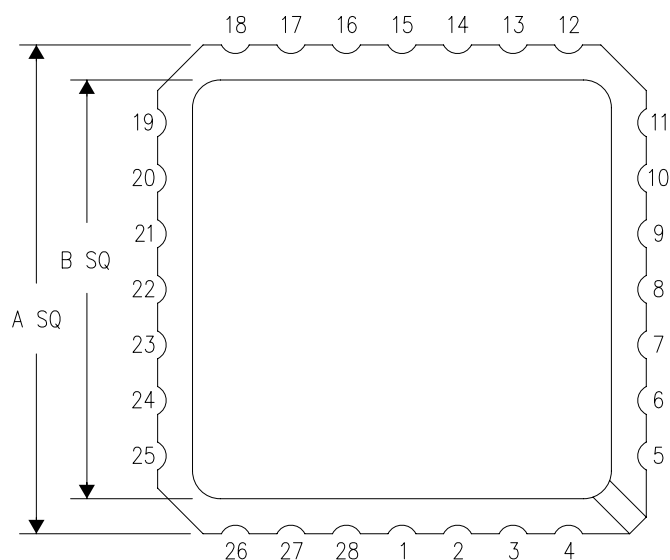

NO. OF TERMINALS **	A		B	
	MIN	MAX	MIN	MAX
20	0.342 (8,69)	0.358 (9,09)	0.307 (7,80)	0.358 (9,09)
28	0.442 (11,23)	0.458 (11,63)	0.406 (10,31)	0.458 (11,63)
44	0.640 (16,26)	0.660 (16,76)	0.495 (12,58)	0.560 (14,22)
52	0.740 (18,78)	0.761 (19,32)	0.495 (12,58)	0.560 (14,22)
68	0.938 (23,83)	0.962 (24,43)	0.850 (21,6)	0.858 (21,8)
84	1.141 (28,99)	1.165 (29,59)	1.047 (26,6)	1.063 (27,0)

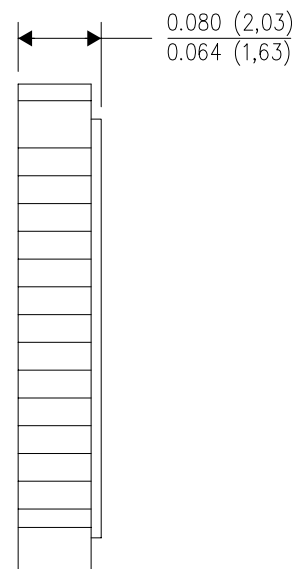
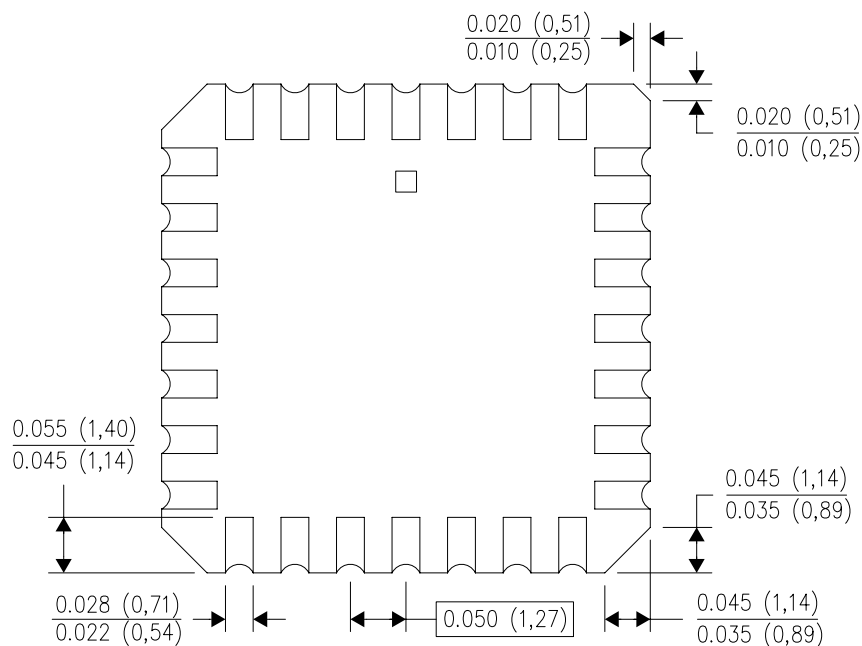

4040140/D 01/11

- NOTES:
- All linear dimensions are in inches (millimeters).
  - This drawing is subject to change without notice.
  - This package can be hermetically sealed with a metal lid.
  - Falls within JEDEC MS-004

P (R-PDIP-T8)

PLASTIC DUAL-IN-LINE PACKAGE

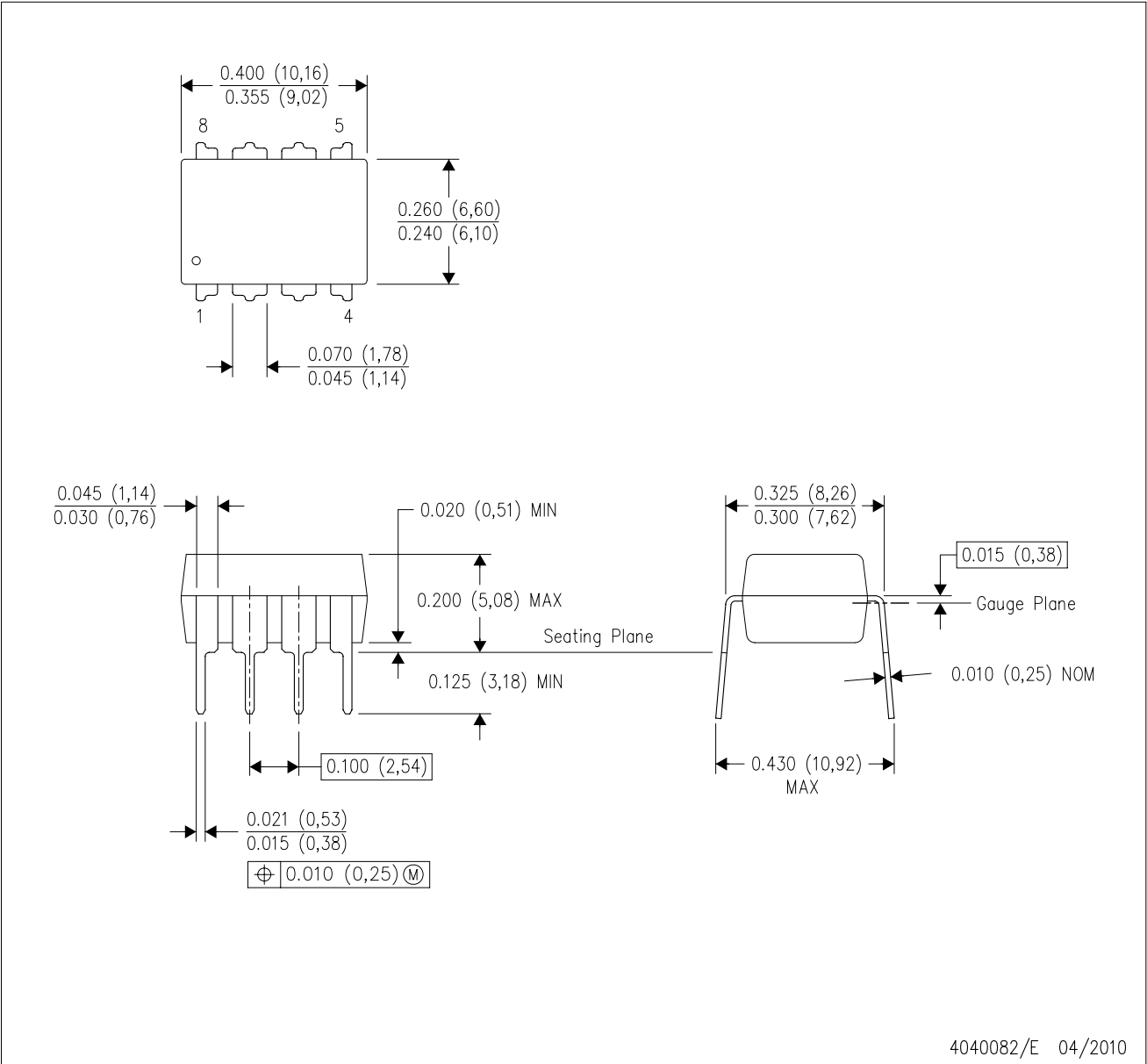



NOTES: A. All linear dimensions are in inches (millimeters).  
B. This drawing is subject to change without notice.  
C. Falls within JEDEC MS-001 variation BA.

D (R-PDSO-G14)

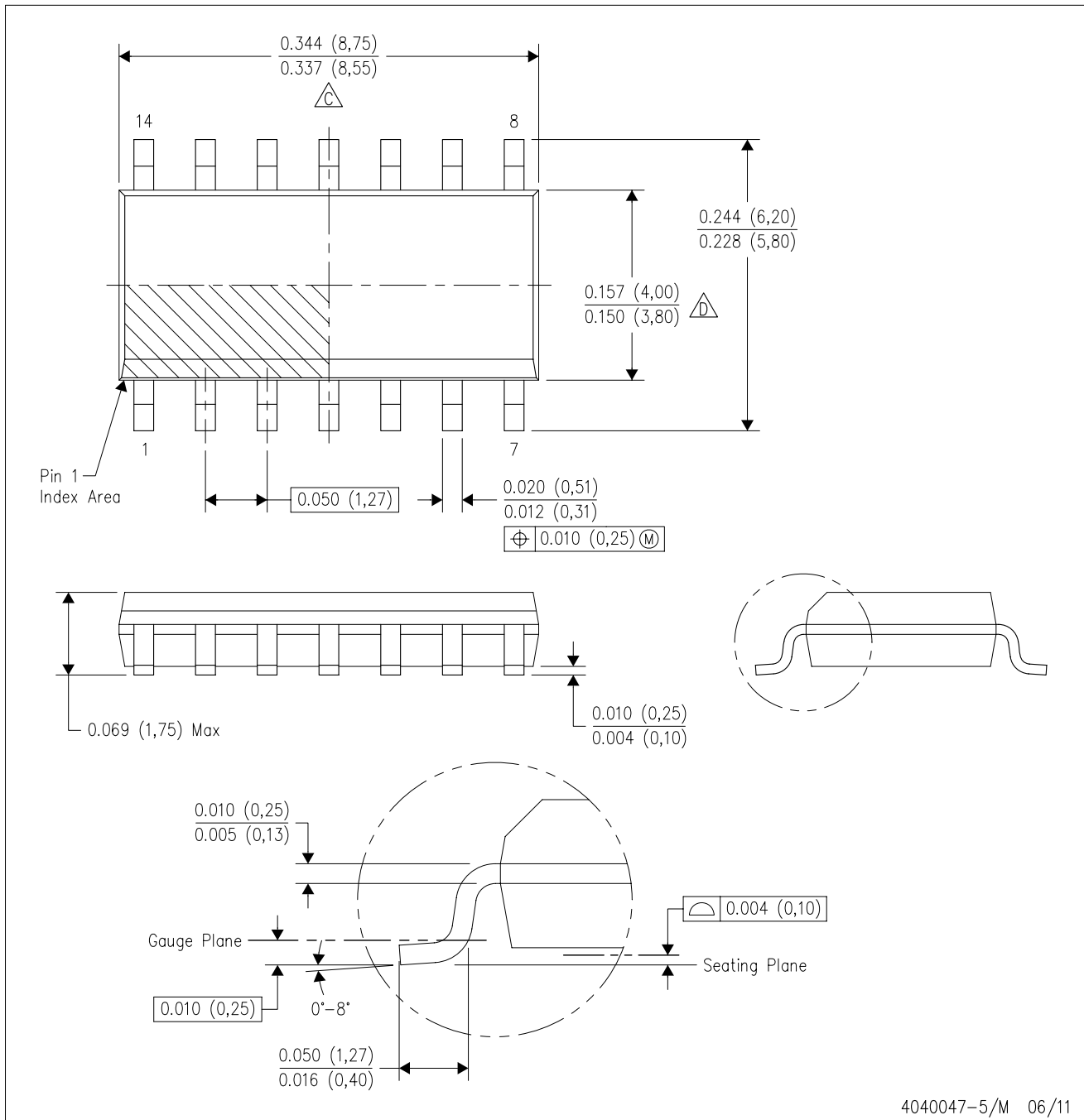
PLASTIC SMALL OUTLINE



- NOTES:
- A. All linear dimensions are in inches (millimeters).
  - B. This drawing is subject to change without notice.
  -  Body length does not include mold flash, protrusions, or gate burrs. Mold flash, protrusions, or gate burrs shall not exceed 0.006 (0,15) each side.
  -  Body width does not include interlead flash. Interlead flash shall not exceed 0.017 (0,43) each side.
  - E. Reference JEDEC MS-012 variation AB.

D (R-PDSO-G14)

PLASTIC SMALL OUTLINE

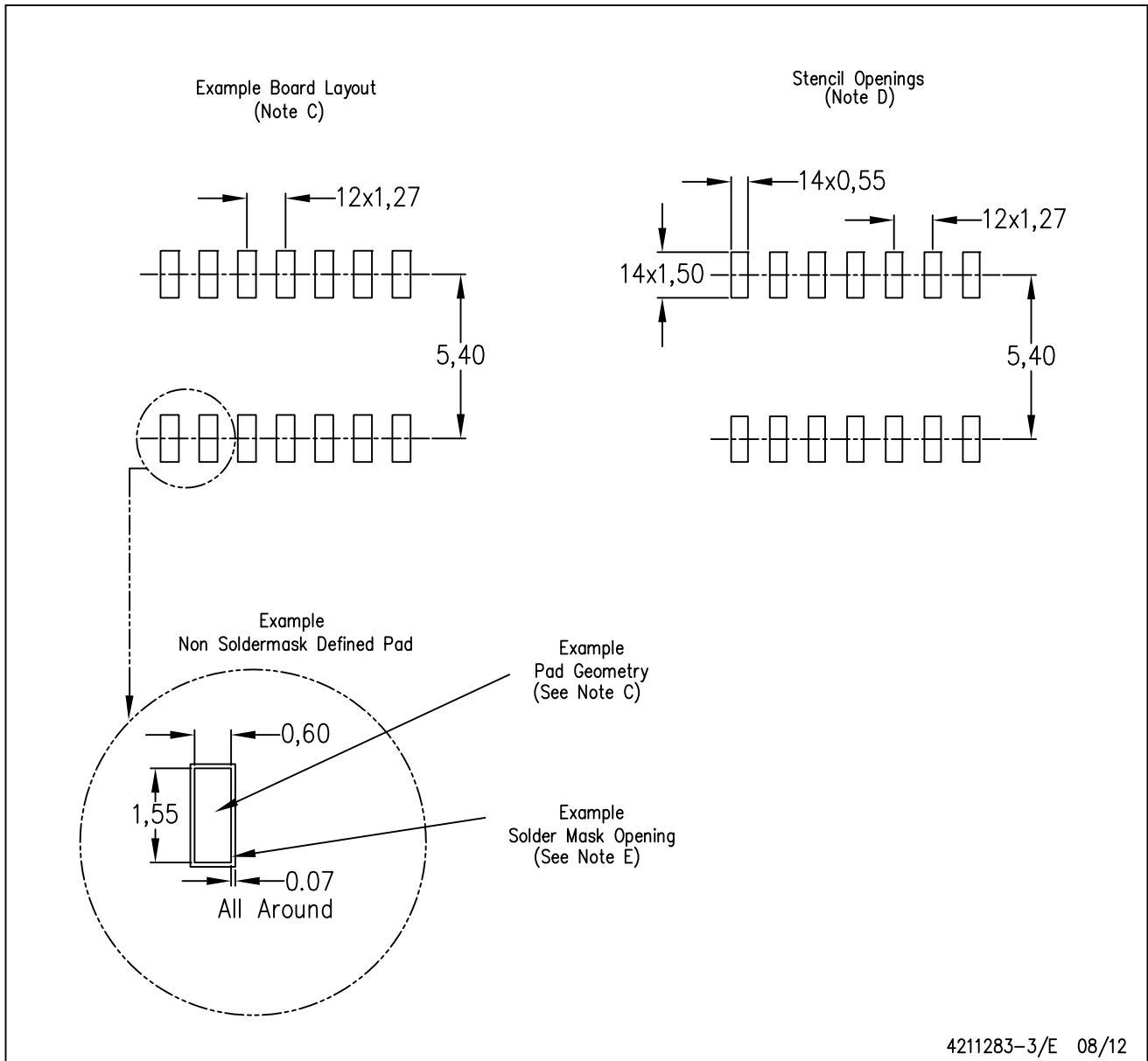

4211283-3/E 08/12

- NOTES:
- All linear dimensions are in millimeters.
  - This drawing is subject to change without notice.
  - Publication IPC-7351 is recommended for alternate designs.
  - Laser cutting apertures with trapezoidal walls and also rounding corners will offer better paste release. Customers should contact their board assembly site for stencil design recommendations. Refer to IPC-7525 for other stencil recommendations.
  - Customers should contact their board fabrication site for solder mask tolerances between and around signal pads.

D (R-PDSO-G8)

PLASTIC SMALL OUTLINE

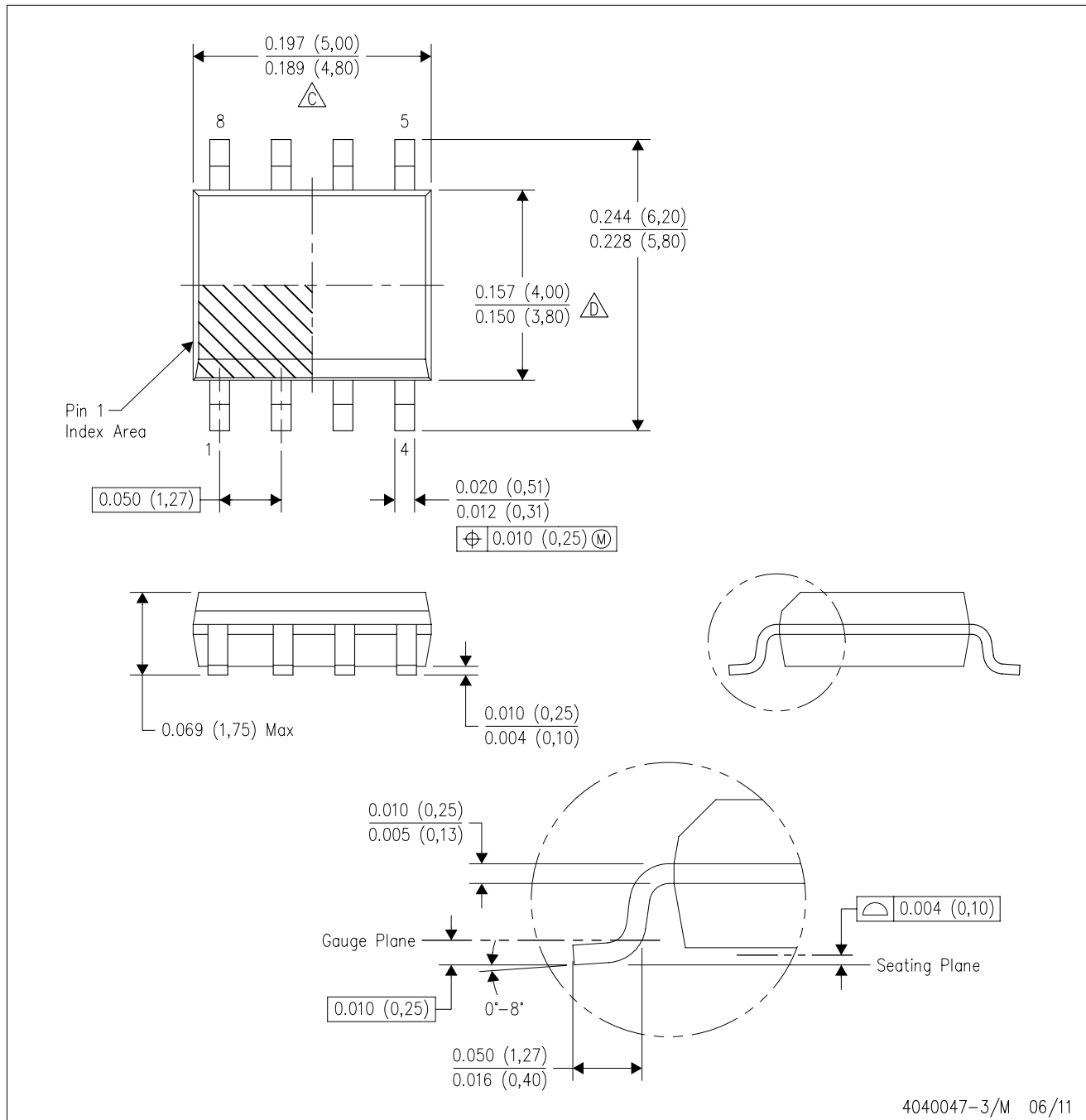

4040047-3/M 06/11

- NOTES:
- A. All linear dimensions are in inches (millimeters).
  - B. This drawing is subject to change without notice.
  - $\triangle C$  Body length does not include mold flash, protrusions, or gate burrs. Mold flash, protrusions, or gate burrs shall not exceed 0.006 (0,15) each side.
  - $\triangle D$  Body width does not include interlead flash. Interlead flash shall not exceed 0.017 (0,43) each side.
  - E. Reference JEDEC MS-012 variation AA.

D (R-PDSO-G8)

PLASTIC SMALL OUTLINE

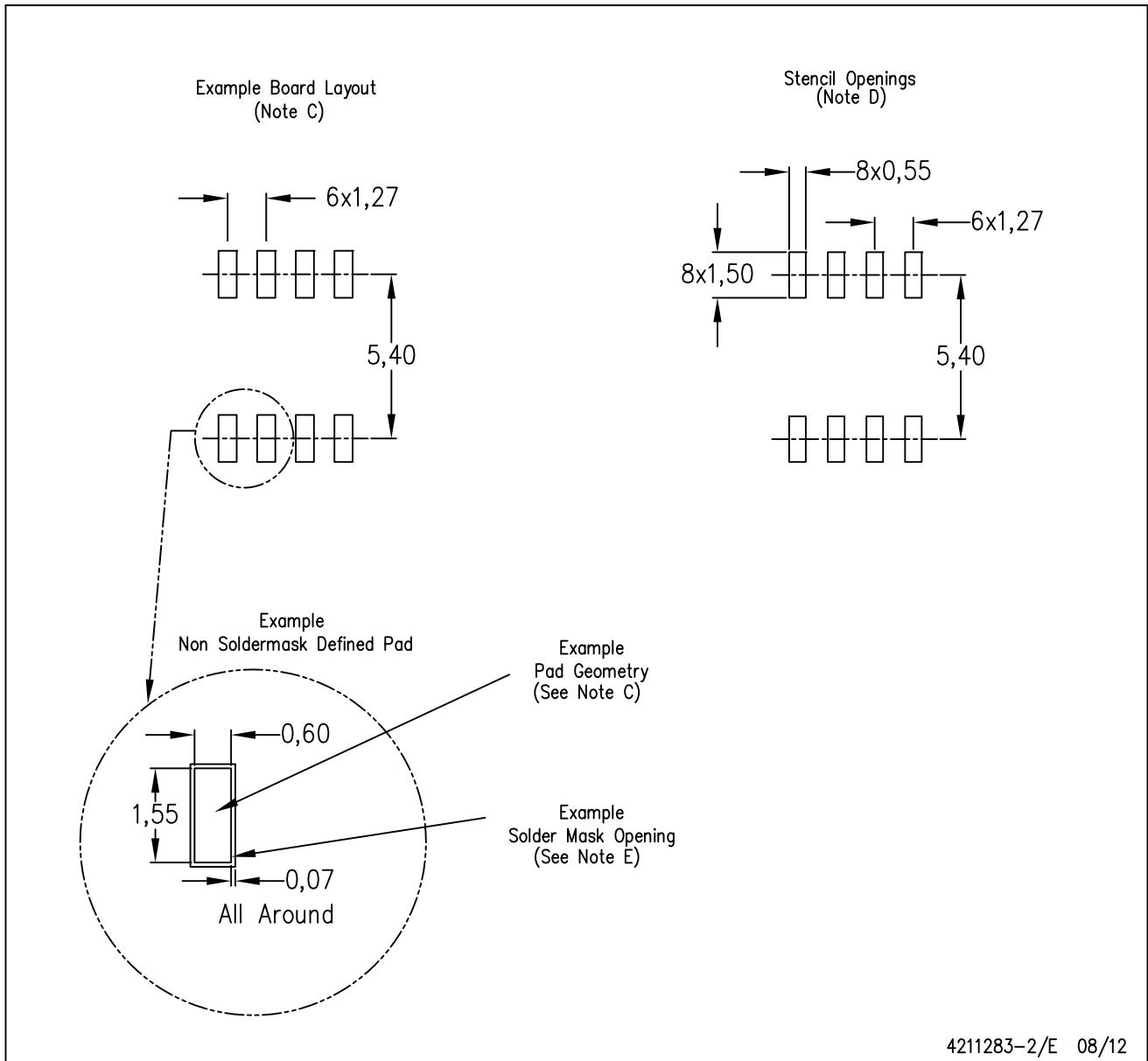

- NOTES:
- All linear dimensions are in millimeters.
  - This drawing is subject to change without notice.
  - Publication IPC-7351 is recommended for alternate designs.
  - Laser cutting apertures with trapezoidal walls and also rounding corners will offer better paste release. Customers should contact their board assembly site for stencil design recommendations. Refer to IPC-7525 for other stencil recommendations.
  - Customers should contact their board fabrication site for solder mask tolerances between and around signal pads.

## IMPORTANT NOTICE

Texas Instruments Incorporated and its subsidiaries (TI) reserve the right to make corrections, enhancements, improvements and other changes to its semiconductor products and services per JESD46, latest issue, and to discontinue any product or service per JESD48, latest issue. Buyers should obtain the latest relevant information before placing orders and should verify that such information is current and complete. All semiconductor products (also referred to herein as "components") are sold subject to TI's terms and conditions of sale supplied at the time of order acknowledgment.

TI warrants performance of its components to the specifications applicable at the time of sale, in accordance with the warranty in TI's terms and conditions of sale of semiconductor products. Testing and other quality control techniques are used to the extent TI deems necessary to support this warranty. Except where mandated by applicable law, testing of all parameters of each component is not necessarily performed.

TI assumes no liability for applications assistance or the design of Buyers' products. Buyers are responsible for their products and applications using TI components. To minimize the risks associated with Buyers' products and applications, Buyers should provide adequate design and operating safeguards.

TI does not warrant or represent that any license, either express or implied, is granted under any patent right, copyright, mask work right, or other intellectual property right relating to any combination, machine, or process in which TI components or services are used. Information published by TI regarding third-party products or services does not constitute a license to use such products or services or a warranty or endorsement thereof. Use of such information may require a license from a third party under the patents or other intellectual property of the third party, or a license from TI under the patents or other intellectual property of TI.

Reproduction of significant portions of TI information in TI data books or data sheets is permissible only if reproduction is without alteration and is accompanied by all associated warranties, conditions, limitations, and notices. TI is not responsible or liable for such altered documentation. Information of third parties may be subject to additional restrictions.

Resale of TI components or services with statements different from or beyond the parameters stated by TI for that component or service voids all express and any implied warranties for the associated TI component or service and is an unfair and deceptive business practice. TI is not responsible or liable for any such statements.

Buyer acknowledges and agrees that it is solely responsible for compliance with all legal, regulatory and safety-related requirements concerning its products, and any use of TI components in its applications, notwithstanding any applications-related information or support that may be provided by TI. Buyer represents and agrees that it has all the necessary expertise to create and implement safeguards which anticipate dangerous consequences of failures, monitor failures and their consequences, lessen the likelihood of failures that might cause harm and take appropriate remedial actions. Buyer will fully indemnify TI and its representatives against any damages arising out of the use of any TI components in safety-critical applications.

In some cases, TI components may be promoted specifically to facilitate safety-related applications. With such components, TI's goal is to help enable customers to design and create their own end-product solutions that meet applicable functional safety standards and requirements. Nonetheless, such components are subject to these terms.

No TI components are authorized for use in FDA Class III (or similar life-critical medical equipment) unless authorized officers of the parties have executed a special agreement specifically governing such use.

Only those TI components which TI has specifically designated as military grade or "enhanced plastic" are designed and intended for use in military/aerospace applications or environments. Buyer acknowledges and agrees that any military or aerospace use of TI components which have **not** been so designated is solely at the Buyer's risk, and that Buyer is solely responsible for compliance with all legal and regulatory requirements in connection with such use.

TI has specifically designated certain components as meeting ISO/TS16949 requirements, mainly for automotive use. In any case of use of non-designated products, TI will not be responsible for any failure to meet ISO/TS16949.

### Products

Audio	<a href="http://www.ti.com/audio">www.ti.com/audio</a>
Amplifiers	<a href="http://amplifier.ti.com">amplifier.ti.com</a>
Data Converters	<a href="http://dataconverter.ti.com">dataconverter.ti.com</a>
DLP® Products	<a href="http://www.dlp.com">www.dlp.com</a>
DSP	<a href="http://dsp.ti.com">dsp.ti.com</a>
Clocks and Timers	<a href="http://www.ti.com/clocks">www.ti.com/clocks</a>
Interface	<a href="http://interface.ti.com">interface.ti.com</a>
Logic	<a href="http://logic.ti.com">logic.ti.com</a>
Power Mgmt	<a href="http://power.ti.com">power.ti.com</a>
Microcontrollers	<a href="http://microcontroller.ti.com">microcontroller.ti.com</a>
RFID	<a href="http://www.ti-rfid.com">www.ti-rfid.com</a>
OMAP Applications Processors	<a href="http://www.ti.com/omap">www.ti.com/omap</a>
Wireless Connectivity	<a href="http://www.ti.com/wirelessconnectivity">www.ti.com/wirelessconnectivity</a>

### Applications

Automotive and Transportation	<a href="http://www.ti.com/automotive">www.ti.com/automotive</a>
Communications and Telecom	<a href="http://www.ti.com/communications">www.ti.com/communications</a>
Computers and Peripherals	<a href="http://www.ti.com/computers">www.ti.com/computers</a>
Consumer Electronics	<a href="http://www.ti.com/consumer-apps">www.ti.com/consumer-apps</a>
Energy and Lighting	<a href="http://www.ti.com/energy">www.ti.com/energy</a>
Industrial	<a href="http://www.ti.com/industrial">www.ti.com/industrial</a>
Medical	<a href="http://www.ti.com/medical">www.ti.com/medical</a>
Security	<a href="http://www.ti.com/security">www.ti.com/security</a>
Space, Avionics and Defense	<a href="http://www.ti.com/space-avionics-defense">www.ti.com/space-avionics-defense</a>
Video and Imaging	<a href="http://www.ti.com/video">www.ti.com/video</a>

### TI E2E Community

[e2e.ti.com](http://e2e.ti.com)