



### Main

Range of Product	Modicon TM7
Product or Component Type	CANopen interface I/O block
Range Compatibility	Modicon LMC058 Modicon M258
Enclosure Material	Plastic
Bus type	CANopen
[Ue] rated operational voltage	24 V DC
Input/output number	16
Input/output number of block	16 I/O

### Complementary

Discrete input number	0...16 configurable by software
Discrete input voltage	24 V
Discrete input voltage type	DC
Discrete input current	4.4 mA
Discrete input logic	Positive
Discrete output number	0...16 configurable by software
Discrete output voltage	24 V
Discrete output voltage type	DC
Discrete output current	<= 0.5 A
Discrete output type	Transistor
Sensor power supply	24 V, 500 mA for all channels overload, short-circuit and reverse polarity protection
Electrical connection	1 male connector M12 - A coding - 5 ways CANopen bus IN 1 female connector M12 - B coding - 4 ways TM7 bus OUT 1 male connector M8 - 4 ways power IN 1 female connector M8 - 4 ways power OUT 1 female connector M12 - A coding - 5 ways CANopen bus OUT 8 female connectors M12 - A coding - 5 ways sensor or actuator
Local signalling	For bus diagnostic 2 LEDs For actuator power supply diagnostics 1 LED For sensor power supply diagnostics 1 LED
Operating position	Any position
Fixing Mode	By 2 screws
Net Weight	0.71 lb(US) (0.32 kg)

### Environment

Standards	IEC 61131-2
Product Certifications	ATEX II 3g EEx nA II T5 C-tick CURus GOST-R
Marking	CE
Ambient air temperature for operation	14...140 °F (-10...60 °C)
Ambient Air Temperature for Storage	-13...185 °F (-25...85 °C)
Relative humidity	5...95 % without condensation or dripping water
Pollution degree	2 IEC 60664

IP degree of protection	IP67 conforming to IEC 61131-2
Operating altitude	0...6561.68 ft (0...2000 m)
Storage altitude	0.00...9842.52 ft (0...3000 m)
Vibration resistance	7.5 mm constant amplitude 2...8 Hz)IEC 60721-3-5 Class 5M3 2 gn constant acceleration 8...200 Hz)IEC 60721-3-5 Class 5M3 4 gn constant acceleration 200...500 Hz)IEC 60721-3-5 Class 5M3
Shock resistance	30 gn 11 ms IEC 60721-3-5 Class 5M3
Resistance to electrostatic discharge	6 kV in contact EN/IEC 61000-4-2 8 kV in air EN/IEC 61000-4-2
Resistance to electromagnetic fields	9.14 V/M (10 V/m) 0.08...2 Hz EN/IEC 61000-4-3 0.91 V/m (1 V/m) 2...2.7 Hz EN/IEC 61000-4-3
Resistance to fast transients	2 kV EN/IEC 61000-4-4 power supply) 1 kV EN/IEC 61000-4-4 input/output) 1 kV EN/IEC 61000-4-4 shielded cable)
Surge withstand for DC 24 V circuit	1 kV power supply (common mode) EN/IEC 61000-4-5 0.5 kV power supply (differential mode) EN/IEC 61000-4-5 1 kV unshielded links (common mode) EN/IEC 61000-4-5 0.5 kV unshielded links (differential mode) EN/IEC 61000-4-5 1 kV shielded links (common mode) EN/IEC 61000-4-5 0.5 kV shielded links (differential mode) EN/IEC 61000-4-5
Electromagnetic compatibility	EN/IEC 61000-4-6
Disturbance radiated/conducted	CISPR 11

## Ordering and shipping details

Category	22532 - M258 PLC
Discount Schedule	PC12
GTIN	3595864092805
Nbr. of units in pkg.	1
Package weight(Lbs)	14.46 oz (410 g)
Returnability	No
Country of origin	AT

## Packing Units

Unit Type of Package 1	PCE
Package 1 Height	1.77 in (4.5 cm)
Package 1 width	2.17 in (5.5 cm)
Package 1 Length	6.89 in (17.5 cm)

## Offer Sustainability

Sustainable offer status	Green Premium product
California proposition 65	WARNING: This product can expose you to chemicals including: Lead and lead compounds, which is known to the State of California to cause cancer and birth defects or other reproductive harm. For more information go to <a href="http://www.P65Warnings.ca.gov">www.P65Warnings.ca.gov</a>
REACH Regulation	<a href="#">REACH Declaration</a>
REACH free of SVHC	Yes
EU RoHS Directive	Pro-active compliance (Product out of EU RoHS legal scope) <a href="#">EU RoHS Declaration</a>
Toxic heavy metal free	Yes
Mercury free	Yes
RoHS exemption information	<a href="#">Yes</a>
China RoHS Regulation	<a href="#">China RoHS Declaration</a>
Environmental Disclosure	<a href="#">Product Environmental Profile</a>
Circularity Profile	<a href="#">End Of Life Information</a>
WEEE	The product must be disposed on European Union markets following specific waste collection and never end up in rubbish bins.
PVC free	Yes

## Contractual warranty

---

Warranty	18 months
----------	-----------

---

TM7 CANopen Interface I/O Block

Description

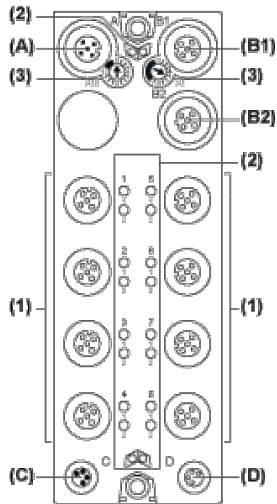

- (A) CANopen bus IN connector
- (B1) CANopen bus OUT connector
- (B2) TM7 bus OUT connector
- (C) 24 Vdc power IN connector
- (D) 24 Vdc power OUT connector
- (1) Input / Output connectors
- (2) Status and channel LEDs
- (3) CANopen Address settings rotary switches

Connector and Channel Assignments

I/O connectors	Channel types	Channels
1	Input/Output	I0/Q0
2	Input/Output	I1/Q1
3	Input/Output	I2/Q2
4	Input/Output	I3/Q3
5	Input/Output	I4/Q4
6	Input/Output	I5/Q5
7	Input/Output	I6/Q6
8	Input/Output	I7/Q7
9	Input/Output	I8/Q8
10	Input/Output	I9/Q9
11	Input/Output	I10/Q10
12	Input/Output	I11/Q11
13	Input/Output	I12/Q12
14	Input/Output	I13/Q13
15	Input/Output	I14/Q14
16	Input/Output	I15/Q15

TM7 Block, Size 2

Dimensions

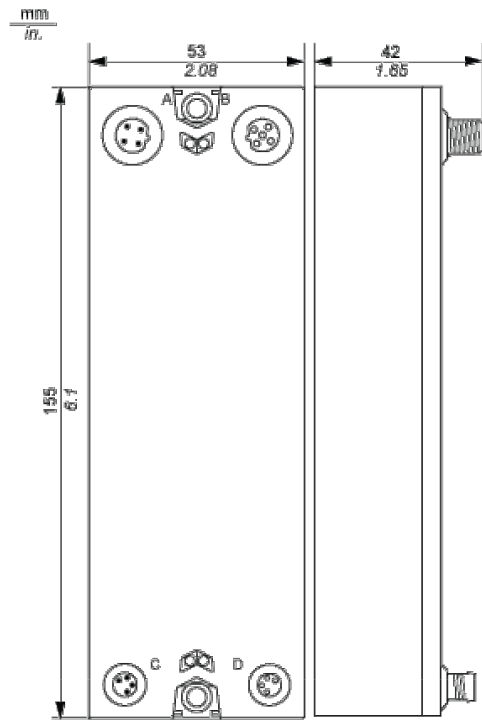

Spacing Requirements

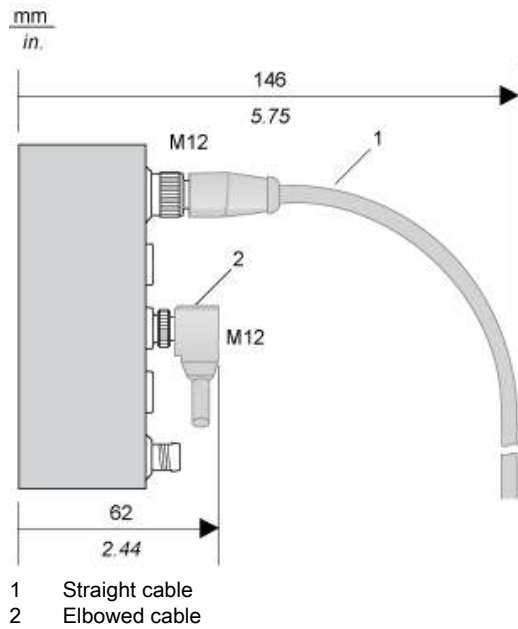

Installation Guidelines

TM7 Block on an Aluminium Frame

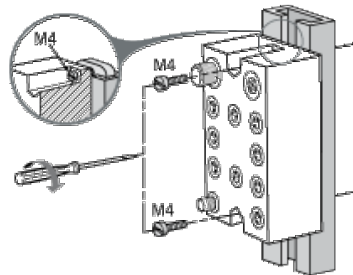

NOTE: Maximum torque to fasten the required M4 screws is 0.6 N.m (5.3 lbf-in).

TM7 Block on a DIN Rail

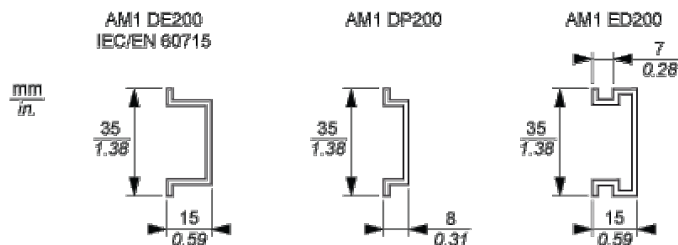

NOTE: Only size 1 (smallest) blocks can be installed on DIN rail with the TM7ACMP mounting plate.

## TM7 Block Directly on the Machine

Drilling template of the block:

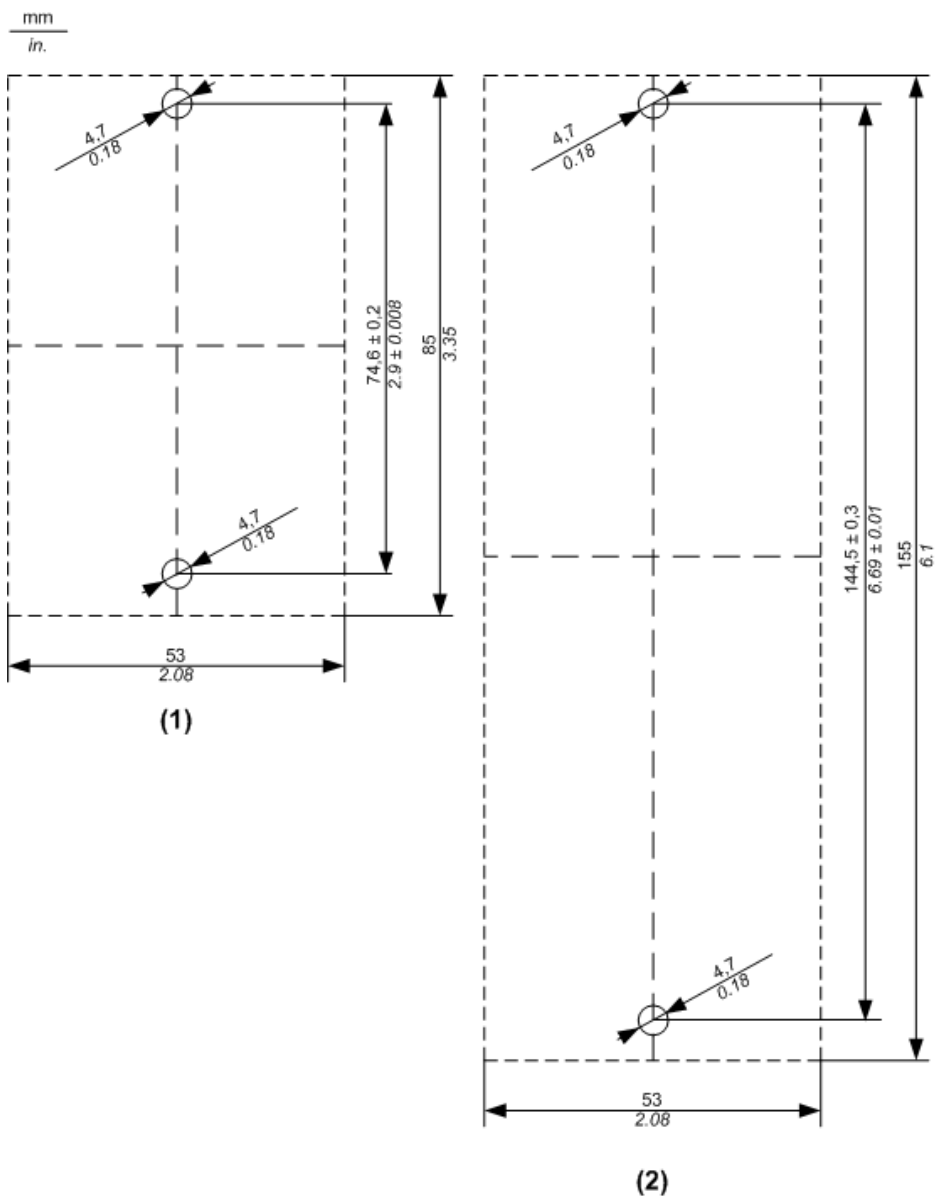

- (1) Size 1
- (2) Size 2

The thickness of the base plate should be taken into consideration when defining the screw length.

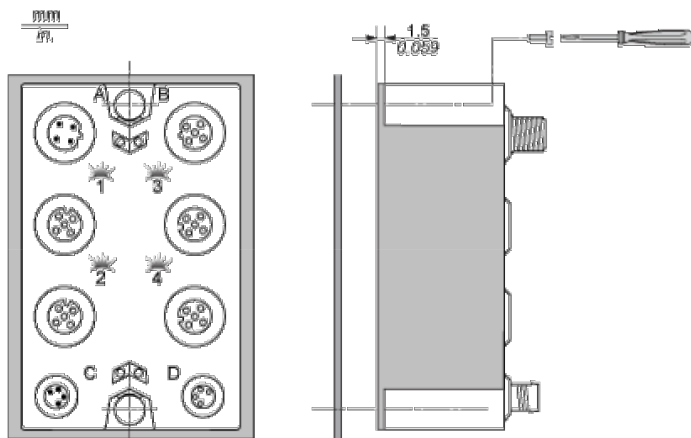

NOTE: Maximum torque to fasten the required M4 screws is 0.6 N.m (5.3 lbf-in).

Wiring Diagram

Pin Assignments for I/O Connectors

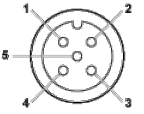
Connection	Pin	Designation
	1	24 Vdc sensor supply
	2	DI: input signal channel 1
	3	0 Vdc
	4	DI: input signal channel 2
	5	N.C.

CANopen Pins and Connectors

Connector Assignments

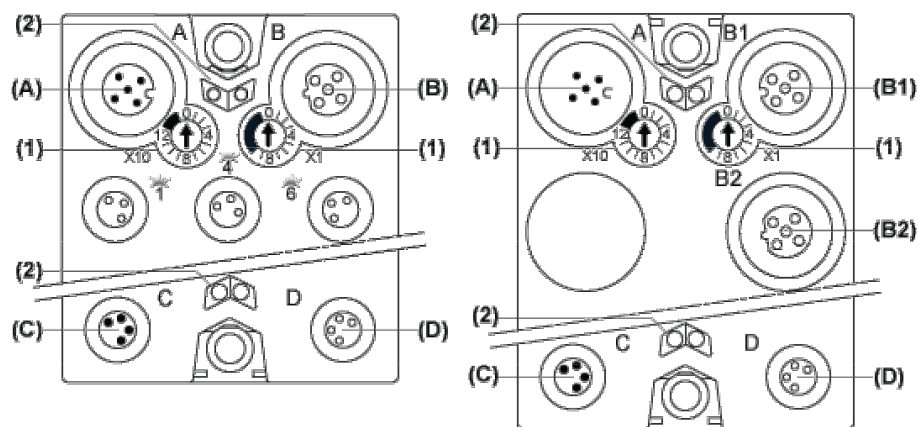

- (A) Field bus IN connector
- (B) TM7 bus OUT connector M12
- and
- (B2)
- (B1) CANopen bus OUT connector M12
- (C) 24 Vdc power IN connector
- (D) 24 Vdc power OUT connector
- (1) Address settings rotary switches
- (2) Status LEDs

Pin Assignments

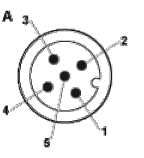
Connectors	Pin	Designation
	1	CAN_SHLD
	2	(CAN_V+)
	3	CAN_GND

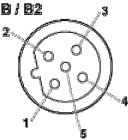
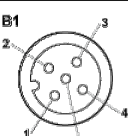
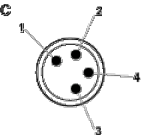
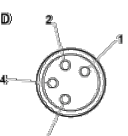

Connectors	Pin	Designation	
4	CAN_H		
5	CAN_L		
	1		TM7 V+
2	TM7 Bus Data		
3	TM7 0V		
4	TM7 Bus Data		
5	N.C.		
	1	CAN_SHLD	
2	(CAN_V+)		
3	CAN_GND		
4	CAN_H		
5	CAN_L		
Connectors	Pin	Designation	
	1	24 Vdc main power	
2	24 Vdc I/O power segment		
3	0 Vdc		
4	0 Vdc		
	1	24 Vdc I/O power segment	
2	24 Vdc I/O power segment		
3	0 Vdc		
4	0 Vdc		

### Wiring the Power Supply

Connections	2 Power Supplies
24 Vdc main power that generates power for TM7 power bus	PS1
24 Vdc I/O power segment	PS2

TM7NCOM●●

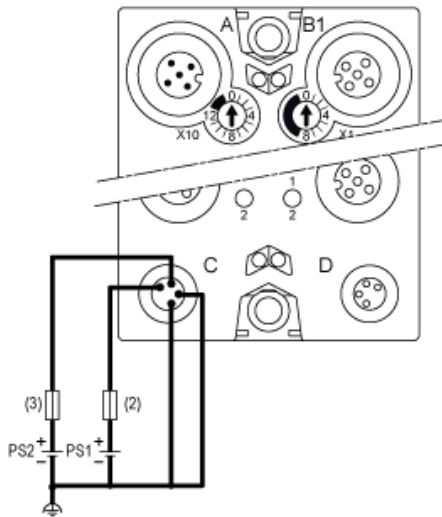

- (2) External fuse, Type T slow-blow, 1 A, 250 V <sup>1</sup>
- (3) External fuse, Type T slow-blow, 4 A max., 250 V
- PS1 External isolated main power supply, 24 Vdc
- PS2 External isolated I/O power supply, 24 Vdc

<sup>1</sup> Fuse limited to 1 A per PDB, maximum fuse limited to 5 A with maximum 4 PDB interconnected. If less than 4 PDBs size the fuse in accordance with the number of PDBs.

Switching Inductive Load Characteristics

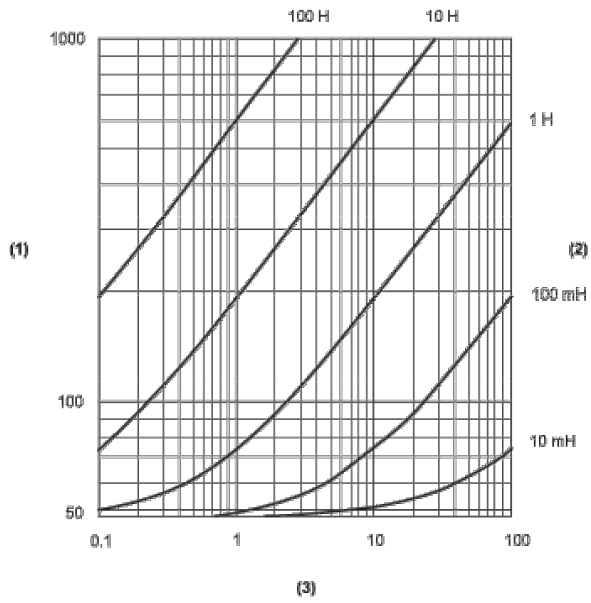

- (1) Load resistance in  $\Omega$
- (2) Load inductance in H
- (3) Max. operating cycles / second