

**Features**

- Ideal for indication light on hand held products
- Long life and robust package
- Standard Package: 2,000pcs/ Reel
- MSL (Moisture Sensitivity Level): 3
- RoHS compliant



**ATTENTION**  
OBSERVE PRECAUTIONS  
FOR HANDLING  
ELECTROSTATIC  
DISCHARGE  
SENSITIVE  
DEVICES

**Package Schematics**

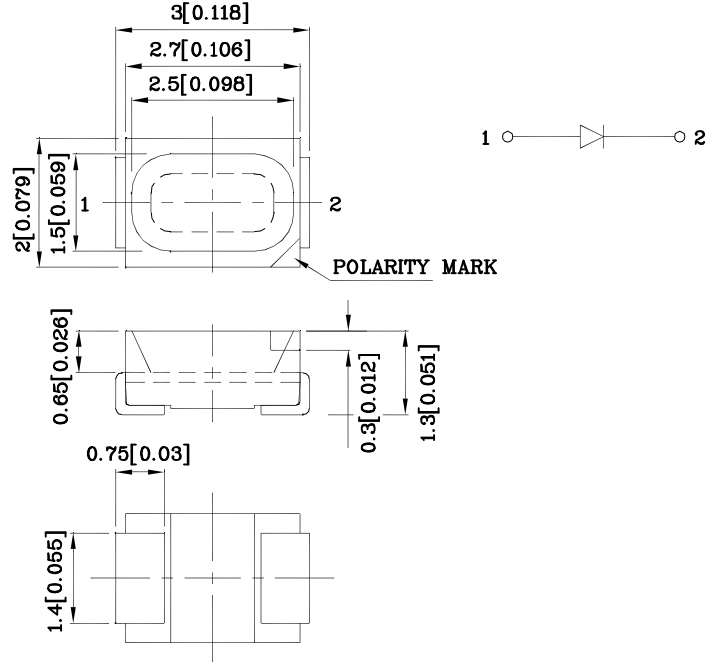

**Notes:**

1. All dimensions are in millimeters (inches).
2. Tolerance is  $\pm 0.2(0.008)$  unless otherwise noted.
3. Specifications are subject to change without notice.

Absolute Maximum Ratings ( $T_A=25^\circ\text{C}$ )		CWD (InGaN)	Unit
Reverse Voltage	$V_R$	5	V
Forward Current	$I_F$	30	mA
Forward Current (Peak) 1/10 Duty Cycle 0.1ms Pulse Width	$i_{FS}$	150	mA
Power Dissipation	$P_D$	120	mW
Electrostatic Discharge Threshold (HBM)		250	V
Operating Temperature	$T_A$	-40 ~ +85	°C
Storage Temperature	$T_{stg}$	-40 ~ +85	

Operating Characteristics ( $T_A=25^\circ\text{C}$ )		CWD (InGaN)	Unit
Forward Voltage (Typ.) ( $I_F=20\text{mA}$ )	$V_F$	3.3	V
Forward Voltage (Max.) ( $I_F=20\text{mA}$ )	$V_F$	4	V
Reverse Current (Max.) ( $V_R=5\text{V}$ )	$I_R$	50	$\mu\text{A}$
Chromaticity Coordinates (Typ.)	x	0.31	
	y	0.31	
Capacitance (Typ.) ( $V_F=0\text{V}$ , $f=1\text{MHz}$ )	C	100	pF

Part Number	Emitting Color	Emitting Material	Lens-color	Luminous Intensity CIE127-2007* ( $I_F=20\text{mA}$ ) mcd		Viewing Angle 20 1/2
				min.	typ.	
XZCWD105S	White	InGaN	Water Clear	300*	597*	125°

\*Luminous intensity value is in accordance with CIE127-2007 standards.

### Handling Precautions

Compare to epoxy encapsulant that is hard and brittle, silicone is softer and flexible. Although its characteristic significantly reduces thermal stress, it is more susceptible to damage by external mechanical force.

As a result, special handling precautions need to be observed during assembly using silicone encapsulated LED products. Failure to comply might lead to damage and premature failure of the LED.

1. Handle the component along the side surfaces by using forceps or appropriate tools.

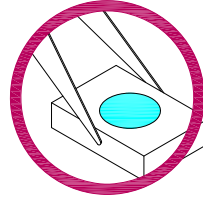

2. Do not directly touch or handle the silicone lens surface. It may damage the internal circuitry.

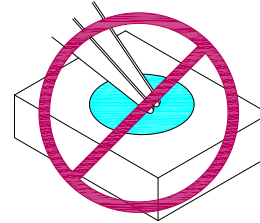
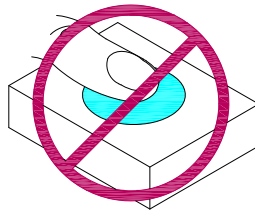

3. Do not stack together assembled PCBs containing exposed LEDs. Impact may scratch the silicone lens or damage the internal circuitry.

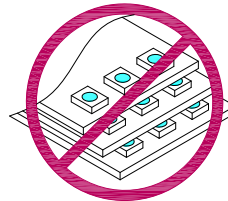

- 4.1. The inner diameter of the SMD pickup nozzle should not exceed the size of the LED to prevent air leaks.
- 4.2. A pliable material is suggested for the nozzle tip to avoid scratching or damaging the LED surface during pickup.
- 4.3. The dimensions of the component must be accurately programmed in the pick-and-place machine to insure precise pickup and avoid damage during production.

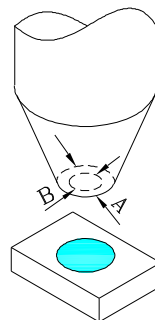

5. As silicone encapsulation is permeable to gases, some corrosive substances such as H<sub>2</sub>S might corrode silver plating of leadframe. Special care should be taken if an LED with silicone encapsulation is to be used near such substances.

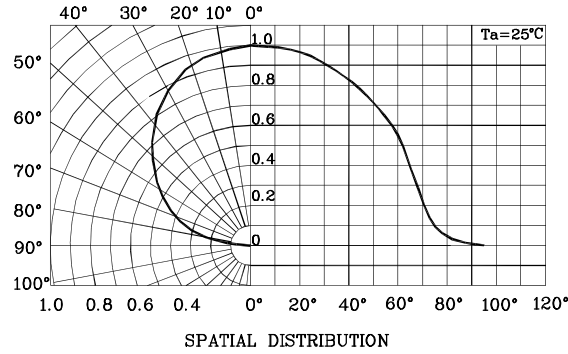

❖ CWD

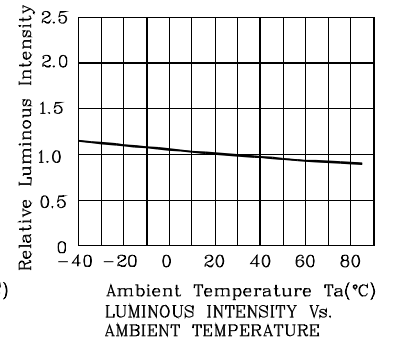
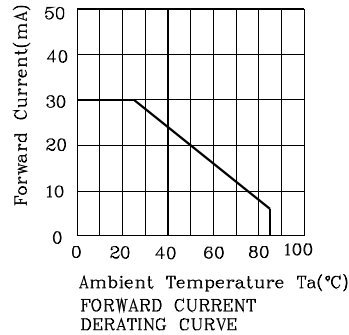
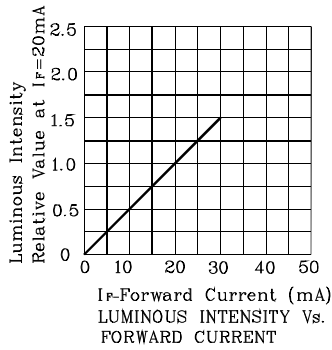
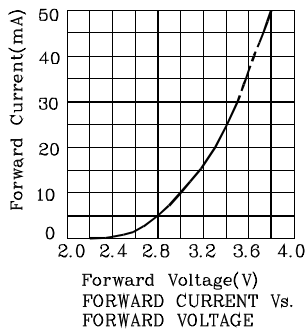

**LED is recommended for reflow soldering and soldering profile is shown below.**

**Reflow Soldering Profile for SMD Products (Pb-Free Components)**



- Notes:
1. Maximum soldering temperature should not exceed 260°C
  2. Recommended reflow temperature: 145°C-260°C
  3. Do not put stress to the epoxy resin during high temperatures conditions



XZCWD105S

White CIE

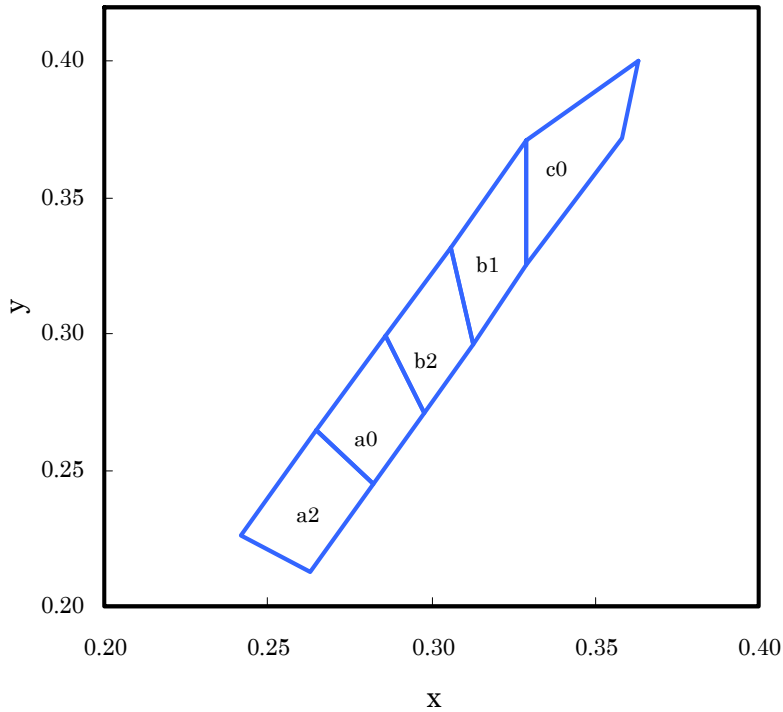

	x	y		x	y		x	y
a2	0.263	0.213	a0	0.282	0.245	b2	0.298	0.271
	0.282	0.245		0.298	0.271		0.313	0.296
	0.265	0.265		0.286	0.299		0.306	0.332
	0.242	0.226		0.265	0.265	0.286	0.299	
b1	0.313	0.296	c0	0.329	0.325			
	0.329	0.325		0.358	0.372			
	0.329	0.371		0.363	0.400			
	0.306	0.332		0.329	0.371			

Notes:  
Shipment may contain more than one chromaticity regions.  
Orders for single chromaticity region are generally not accepted.  
Measurement tolerance of the chromaticity coordinates is  $\pm 0.01$ .



❖ The device has a single mounting surface.  
The device must be mounted according to the specifications.

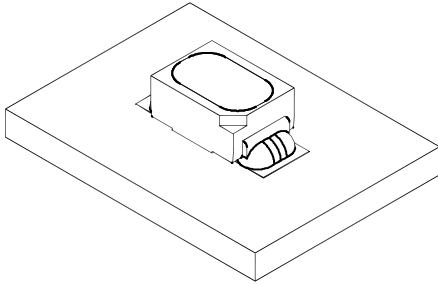

❖ Recommended Soldering Pattern  
(Units : mm; Tolerance: ± 0.1)

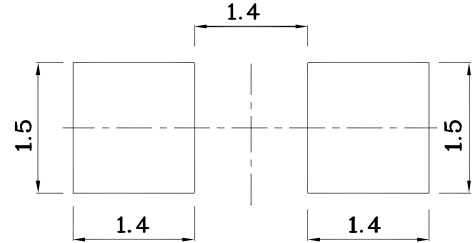

❖ Reel Dimension

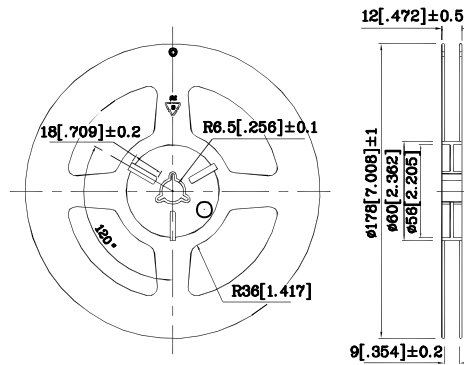

❖ Tape Specification (Units : mm)

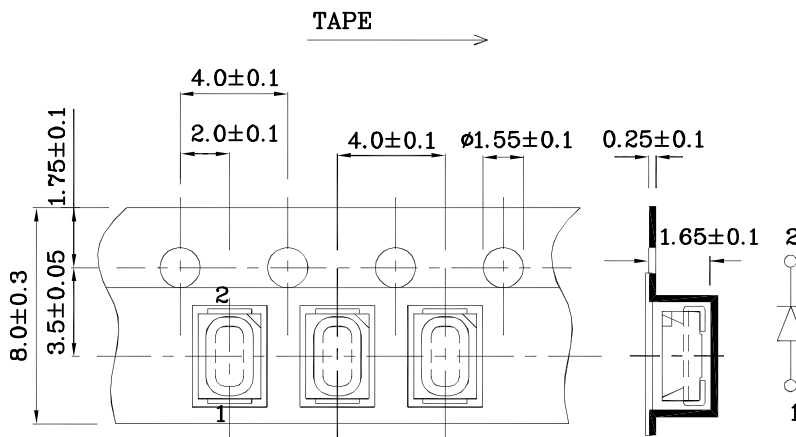



Remarks:

If special sorting is required (e.g. binning based on forward voltage, luminous intensity / luminous flux or chromaticity), the typical accuracy of the sorting process is as follows:

1. Measurement tolerance of the chromaticity coordinates is ±0.01.
2. Luminous Intensity / Luminous Flux: +/-15%
3. Forward Voltage: +/-0.1V

Note: Accuracy may depend on the sorting parameters.

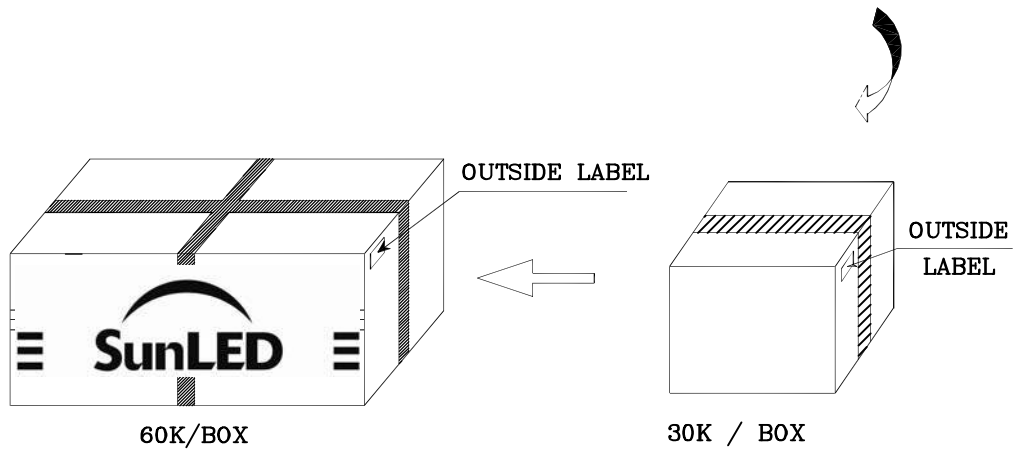
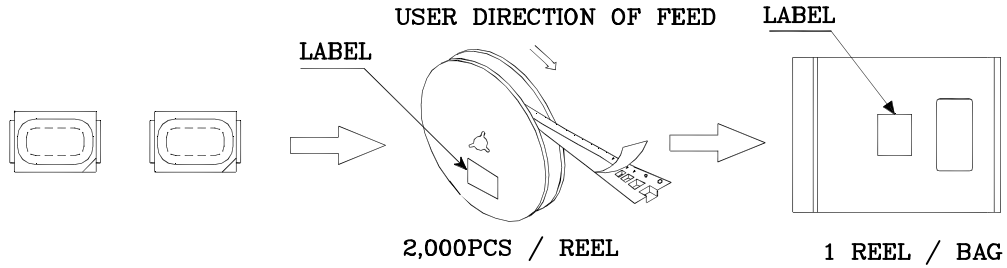
**PACKING & LABEL SPECIFICATIONS**

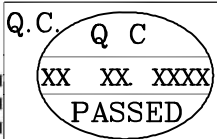
P/NO : XZxxx105x	
QTY : 2,000 pcs	CODE: XXX
S/N : XX	
LOT NO :	
 XXXXXXXXXXXXXXXXXXXXXXXXXXXX	
<b>RoHS Compliant</b>	

**TERMS OF USE**

1. Data presented in this document reflect statistical figures and should be treated as technical reference only.
2. Contents within this document are subject to improvement and enhancement changes without notice.
3. The product(s) in this document are designed to be operated within the electrical and environmental specifications indicated on the datasheet. User accepts full risk and responsibility when operating the product(s) beyond their intended specifications.
4. The product(s) described in this document are intended for electronic applications in which a person's life is not reliant upon the LED. Please consult with a SunLED representative for special applications where the LED may have a direct impact on a person's life.
5. The contents within this document may not be altered without prior consent by SunLED.
6. Additional technical notes are available at <http://www.SunLEDusa.com/TechnicalNotes.asp>