

16-Channel PMBus Power System Manager

FEATURES

- Sequence, Trim, Margin and Supervise 16 Power Supplies
- Manage Faults, Monitor Telemetry and Create Fault Logs
- PMBus™ Compliant Command Set
- Supported by LTpowerPlay® GUI
- Margin or Trim Supplies to Within 0.25% of Target
- Fast OV/UV Supervisors Per Channel
- Coordinate Sequencing and Fault Management Across Multiple LTC PSM Devices
- Automatic Fault Logging to Internal EEPROM
- Operate Autonomously without Additional Software
- Internal Temperature and Input Voltage Supervisors
- Accurate Monitoring of 16 Output Voltages, Two Input Voltages and Internal Die Temperature
- I²C/SMBus Serial Interface
- Can Be Powered from 3.3V, or 4.5V to 15V
- Programmable Watchdog Timer
- Available in 144-Pin 12mm × 12mm BGA Package

APPLICATIONS

- Computers and Network Servers
- Industrial Test and Measurement
- High Reliability Systems
- Medical Imaging
- Video

DESCRIPTION

The LTC[®]2980 is a 16-channel Power System Manager used to sequence, trim (servo), margin, supervise, manage faults, provide telemetry and create fault logs. PMBus commands support power supply sequencing, precision point-of-load voltage adjustment and margining. DACs use a proprietary soft-connect algorithm to minimize supply disturbances. Supervisory functions include overvoltage and undervoltage threshold limits for sixteen power supply output channels and two power supply input channels, as well as over and under temperature limits. Programmable fault responses can disable the power supplies with optional retry after a fault is detected. Faults that disable a power supply can automatically trigger black box EEPROM storage of fault status and associated telemetry. An internal 16-bit ADC monitors sixteen output voltages, two input voltages, and die temperature. In addition, odd numbered channels can be configured to measure the voltage across a current sense resistor. A programmable watchdog timer monitors microprocessor activity for a stalled condition and resets the microprocessor if necessary. A single wire bus synchronizes power supplies across multiple LTC Power System Management (PSM) devices. Configuration EEPROM with ECC supports autonomous operation without additional software.

LT, LTC, LTM, LTpowerPlay, PolyPhase, Linear Technology and the Linear logo are registered trademarks of Analog Devices, Inc. PMBus is a trademark of SMIF, Inc. All other trademarks are the property of their respective owners. Protected by U.S. Patents including 7382303, 7420359 and 7940091.

TYPICAL APPLICATION

16-Channel PMBus Power System Manager

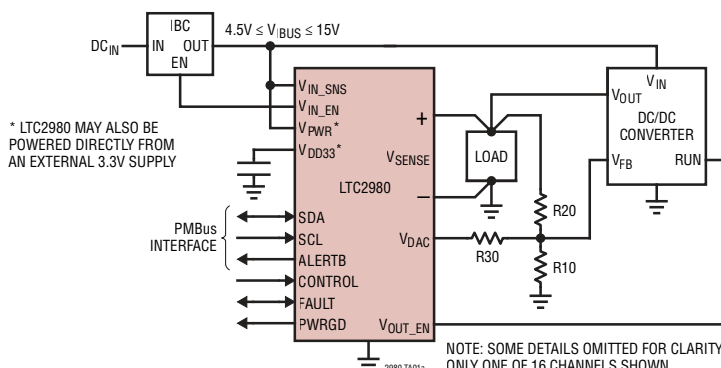

Power Supply Accuracy

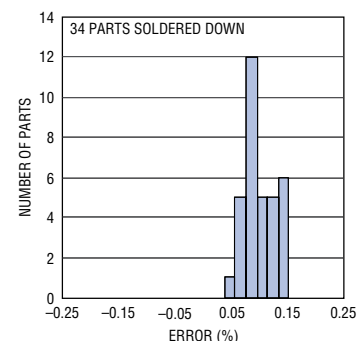

LTC2980

ABSOLUTE MAXIMUM RATINGS

(Notes 1, 2, 3)

Supply Voltages:

V_{PWR}	-0.3V to 15V
V_{IN_SNS}	-0.3V to 15V
V_{DD33}	-0.3V to 3.6V
V_{DD25}	-0.3V to 2.75V

Digital Input/Output Voltages:

ALERTB, SDA, SCL, CONTROL0, CONTROL1.....	-0.3V to 5.5V
PWRGD, SHARE_CLK, WDI/RESETB, WP.....	-0.3V to $V_{DD33} + 0.3V$
FAULTB00, FAULTB01, FAULTB10, FAULTB11.....	-0.3V to $V_{DD33} + 0.3V$
ASELO, ASEL1.....	-0.3V to $V_{DD33} + 0.3V$

Analog Voltages:

REFP.....	-0.3V to 1.35V
REFM.....	-0.3V to 0.3V
$V_{SENSE[7:0]}$	-0.3V to 6V
$V_{SENSEM[7:0]}$	-0.3V to 6V
$V_{OUT_EN[3:0]}$, V_{IN_EN}	-0.3V to 15V
$V_{OUT_EN[7:4]}$	-0.3V to 6V
$V_{DACP[7:0]}$	-0.3V to 6V
$V_{DACM[7:0]}$	-0.3V to 0.3V

Operating Junction Temperature Range:

LTC2980C.....	0°C to 70°C
LTC2980I.....	-40°C to 105°C

Storage Temperature Range -55°C to 125°C*

Maximum Junction Temperature 125°C*

Maximum Solder Temperature..... 260°C

*See OPERATION section of the LTC2977 data sheet for detailed EEPROM derating information for junction temperatures in excess of 105°C.

PIN CONFIGURATION

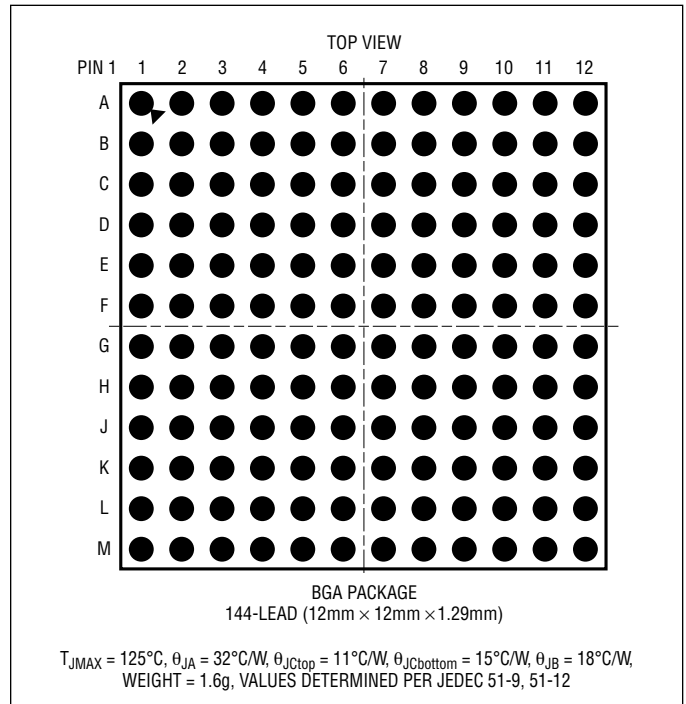

ORDER INFORMATION <http://www.linear.com/product/LTC2980#orderinfo>

PART NUMBER	PAD OR BALL FINISH	PART MARKING*		PACKAGE TYPE	MSL RATING	OPERATING JUNCTION TEMPERATURE RANGE
		DEVICE	FINISH CODE			
LTC2980CY#PBF	SAC305 (RoHS)	LTC2980Y	e1	BGA	3	0°C to 70°C
LTC2980IY#PBF	SAC305 (RoHS)	LTC2980Y	e1	BGA	3	-40°C to 105°C

Consult Marketing for parts specified with wider operating temperature ranges. *Device temperature grade is indicated by a label on the shipping container. Pad or ball finish code is per IPC/JEDEC J-STD-609.

- Terminal Finish Part Marking: www.linear.com/leadfree
- Recommended LGA and BGA PCB Assembly and Manufacturing Procedures: www.linear.com/umodule/pcbassembly
- LGA and BGA Package and Tray Drawings: www.linear.com/packaging

ELECTRICAL CHARACTERISTICS

The ● denotes the specifications which apply over the full operating temperature range, otherwise specifications are at $T_J = 25^\circ\text{C}$. $V_{PWR} = V_{IN_SNS} = 12\text{V}$, V_{DD33} , V_{DD25} and REF pins floating, unless otherwise indicated. (Notes 2, 3)

SYMBOL	PARAMETER	CONDITIONS	MIN	TYP	MAX	UNITS	
Power Supply Characteristics							
V_{PWR}	V_{PWR} Supply Input Operating Range		● 4.5		15	V	
I_{PWR}	V_{PWR} Supply Current	$4.5\text{V} \leq V_{PWR} \leq 15\text{V}$, V_{DD33} Floating	●	10	13	mA	
I_{VDD33}	V_{DD33} Supply Current	$3.13\text{V} \leq V_{DD33} \leq 3.47\text{V}$, $V_{PWR} = V_{DD33}$	●	10	13	mA	
V_{UVLO_VDD33}	V_{DD33} Undervoltage Lockout	V_{DD33} Ramping Up, $V_{PWR} = V_{DD33}$	●	2.35	2.55	2.8	V
	V_{DD33} Undervoltage Lockout Hysteresis			120		mV	
V_{DD33}	Supply Input Operating Range	$V_{PWR} = V_{DD33}$	●	3.13		3.47	V
	Regulator Output Voltage	$4.5\text{V} \leq V_{PWR} \leq 15\text{V}$	●	3.13	3.26	3.47	V
	Regulator Output Short-Circuit Current	$V_{PWR} = 4.5\text{V}$, $V_{DD33} = 0\text{V}$	●	75	90	140	mA
V_{DD25}	Regulator Output Voltage	$3.13\text{V} \leq V_{DD33} \leq 3.47\text{V}$	●	2.35	2.5	2.6	V
	Regulator Output Short-Circuit Current	$V_{PWR} = V_{DD33} = 3.47\text{V}$, $V_{DD25} = 0\text{V}$	●	30	55	80	mA
t_{INIT}	Initialization Time	Time from V_{IN} Applied Until the TON_DELAY Timer Starts		30		ms	
Voltage Reference Characteristics							
V_{REF}	Output Voltage	(Note 4)		1.232		V	
	Temperature Coefficient			3		ppm/ $^\circ\text{C}$	
	Hysteresis	(Note 5)		100		ppm	
ADC Characteristics							
V_{IN_ADC}	Voltage Sense Input Range	Differential Voltage: $V_{IN_ADC} = (V_{SENSEPN} - V_{SENSEMN})$	●	0	6	V	
		Single-Ended Voltage: $V_{SENSEMN}$	●	-0.1	0.1	V	
	Current Sense Input Range (Odd Numbered Channels Only)	Single-Ended Voltage: $V_{SENSEPN}$, $V_{SENSEMN}$	●	-0.1	6	V	
		Differential Voltage: V_{IN_ADC}	●	-170	170	mV	
N_ADC	Voltage Sense Resolution (Uses L16 Format)	$0\text{V} \leq V_{IN_ADC} \leq 6\text{V}$ $Mfr_config_adc_hires = 0$		122		$\mu\text{V}/\text{LSB}$	
	Current Sense Resolution (Odd Numbered Channels Only)	$0\text{mV} \leq V_{IN_ADC} < 16\text{mV}$ (Note 6) $16\text{mV} \leq V_{IN_ADC} < 32\text{mV}$ $32\text{mV} \leq V_{IN_ADC} < 63.9\text{mV}$ $63.9\text{mV} \leq V_{IN_ADC} < 127.9\text{mV}$ $127.9\text{mV} \leq V_{IN_ADC} $ $Mfr_config_adc_hires = 1$		15.625 31.25 62.5 125 250		$\mu\text{V}/\text{LSB}$ $\mu\text{V}/\text{LSB}$ $\mu\text{V}/\text{LSB}$ $\mu\text{V}/\text{LSB}$ $\mu\text{V}/\text{LSB}$	
$TUE_ADC_VOLT_SNS$	Total Unadjusted Error (Note 4)	Voltage Sense Mode $V_{IN_ADC} \geq 1\text{V}$	●		± 0.25	% of Reading	
		Voltage Sense Mode $0 \leq V_{IN_ADC} \leq 1\text{V}$	●		± 2.5	mV	
$TUE_ADC_CURR_SNS$	Total Unadjusted Error (Note 4)	Current Sense Mode, Odd Numbered Channels Only, $20\text{mV} \leq V_{IN_ADC} \leq 170\text{mV}$	●		± 0.7	% of Reading	
		Current Sense Mode, Odd Numbered Channels Only, $V_{IN_ADC} \leq 20\text{mV}$	●		± 140	μV	
V_{OS_ADC}	Offset Error	Current Sense Mode, Odd Numbered Channels Only	●		± 100	μV	
t_{CONV_ADC}	Conversion Time	Voltage Sense Mode (Note 7)		6.15		ms	
		Current Sense Mode (Note 7)		24.6		ms	
		Temperature Input (Note 7)		24.6		ms	

ELECTRICAL CHARACTERISTICS

The ● denotes the specifications which apply over the full operating temperature range, otherwise specifications are at $T_J = 25^\circ\text{C}$. $V_{PWR} = V_{IN_SNS} = 12\text{V}$, V_{DD33} , V_{DD25} and REF pins floating, unless otherwise indicated. (Notes 2, 3)

SYMBOL	PARAMETER	CONDITIONS	MIN	TYP	MAX	UNITS
t_{UPDATE_ADC}	Update Time	Odd Numbered Channels in Current Sense Mode (Note 7)		160		ms
C_{IN_ADC}	Input Sampling Capacitance			1		pF
f_{IN_ADC}	Input Sampling Frequency			62.5		kHz
I_{IN_ADC}	Input Leakage Current	$V_{IN_ADC} = 0\text{V}$, $0\text{V} \leq V_{COMMONMODE} \leq 6\text{V}$, Current Sense Mode	●		± 0.5	μA
	Differential Input Current	$V_{IN_ADC} = 0.17\text{V}$, Current Sense Mode	●	80	250	nA
		$V_{IN_ADC} = 6\text{V}$, Voltage Sense Mode	●	10	15	μA

DAC Output Characteristics

N_{VDACP}	Resolution			10		Bits	
V_{FS_VDACP}	Full-Scale Output Voltage (Programmable)	DAC Code = 0x3FF	●	1.32	1.38	1.44	V
		DAC Polarity = 1	●	2.53	2.65	2.77	V
INL_VDACP	Integral Nonlinearity	(Note 8)	●		± 2	LSB	
DNL_VDACP	Differential Nonlinearity	(Note 8)	●		± 2.4	LSB	
V_{OS_VDACP}	Offset Voltage	(Note 8)	●		± 10	mV	
V_{DACP}	Load Regulation ($V_{DACPn} - V_{DACMn}$)	$V_{DACPn} = 2.65\text{V}$, I_{VDACPn} Sourcing = 2mA		100		ppm/mA	
		$V_{DACPn} = 0.1\text{V}$, I_{VDACPn} Sinking = 2mA		100		ppm/mA	
	PSRR ($V_{DACPn} - V_{DACMn}$)	DC: $3.13\text{V} \leq V_{DD33} \leq 3.47\text{V}$, $V_{PWR} = V_{DD33}$		60		dB	
		100mV Step in 20ns with 50pF Load		40		dB	
	DC CMRR ($V_{DACPn} - V_{DACMn}$)	$-0.1\text{V} \leq V_{DACMn} \leq 0.1\text{V}$		60		dB	
	Leakage Current	V_{DACPn} Hi-Z, $0\text{V} \leq V_{DACPn} \leq 6\text{V}$	●		± 100	nA	
	Short-Circuit Current Low	V_{DACPn} Shorted to GND	●	-10		-4	mA
Short-Circuit Current High	V_{DACPn} Shorted to V_{DD33}	●	4		10	mA	
C_{OUT}	Output Capacitance	V_{DACPn} Hi-Z		10		pF	
t_{S_VDACP}	DAC Output Update Rate	Fast Servo Mode		500		μs	

DAC Soft-Connect Comparator Characteristics

V_{OS_CMP}	Offset Voltage	$V_{DACPn} = 0.2\text{V}$	●	± 1	± 18	mV
		$V_{DACPn} = 1.3\text{V}$	●	± 2	± 26	mV
		$V_{DACPn} = 2.65\text{V}$	●	± 3	± 52	mV

Voltage Supervisor Characteristics

V_{IN_VS}	Input Voltage Range (Programmable)	$V_{IN_VS} = (V_{SENSEPN} - V_{SENSEMn})$	Low Resolution Mode	●	0	6	V
			High Resolution Mode	●	0	3.8	V
		Single-Ended Voltage: $V_{SENSEMn}$	●	-0.1	0.1	V	
N_{VS}	Voltage Sensing Resolution	0V to 3.8V Range: High Resolution Mode		4		mV/LSB	
		0V to 6V Range: Low Resolution Mode		8		mV/LSB	
TUE_VS	Total Unadjusted Error	$2\text{V} \leq V_{IN_VS} \leq 6\text{V}$, Low Resolution Mode	●		± 1.25	% of Reading	
		$1.5\text{V} < V_{IN_VS} \leq 3.8\text{V}$, High Resolution Mode	●		± 1.0	% of Reading	
		$0.8\text{V} \leq V_{IN_VS} \leq 1.5\text{V}$, High Resolution Mode	●		± 1.5	% of Reading	
t_{S_VS}	Update Period			12.21		μs	

ELECTRICAL CHARACTERISTICS The ● denotes the specifications which apply over the full operating temperature range, otherwise specifications are at $T_J = 25^\circ\text{C}$. $V_{PWR} = V_{IN_SNS} = 12\text{V}$, V_{DD33} , V_{DD25} and REF pins floating, unless otherwise indicated. (Notes 2, 3)

SYMBOL	PARAMETER	CONDITIONS		MIN	TYP	MAX	UNITS
V_{IN_SNS} Input Characteristics							
V_{IN_SNS}	V_{IN_SNS} Input Voltage Range		●	0		15	V
R_{VIN_SNS}	V_{IN_SNS} Input Resistance		●	70	90	110	k Ω
TUE_{VIN_SNS}	VIN_ON, VIN_OFF Threshold Total Unadjusted Error	$3\text{V} \leq V_{VIN_SNS} \leq 8\text{V}$	●			± 2.0	% of Reading
		$V_{VIN_SNS} > 8\text{V}$	●			± 1.0	% of Reading
	READ_VIN Total Unadjusted Error	$3\text{V} \leq V_{VIN_SNS} \leq 8\text{V}$	●			± 1.5	% of Reading
		$V_{VIN_SNS} > 8\text{V}$	●			± 1.0	% of Reading
Temperature Sensor Characteristics							
TUE_{TS}	Total Unadjusted Error				± 1		$^\circ\text{C}$
V_{OUT_ENn} Output (V_{OUT_EN} [3:0]) Characteristics							
V_{VOUT_ENn}	Output High Voltage (Note 9)	$I_{VOUT_ENn} = -5\mu\text{A}$, $V_{DD33} = 3.3\text{V}$	●	10	12.5	14.7	V
I_{VOUT_ENn}	Output Sourcing Current	V_{VOUT_ENn} Pull-Up Enabled, $V_{VOUT_ENn} = 1\text{V}$	●	-5	-6	-8	μA
	Output Sinking Current	Strong Pull-Down Enabled, $V_{VOUT_ENn} = 0.4\text{V}$	●	3	5	8	mA
		Weak Pull-Down Enabled, $V_{VOUT_ENn} = 0.4\text{V}$	●	33	50	60	μA
	Output Leakage Current	Internal Pull-Up Disabled, $0\text{V} \leq V_{VOUT_ENn} \leq 15\text{V}$	●			± 1	μA
V_{OUT_ENn} Output (V_{OUT_EN} [7:4]) Characteristics							
I_{VOUT_ENn}	Output Sinking Current	Strong Pull-Down Enabled, $V_{OUT_ENn} = 0.1\text{V}$	●	3	6	9	mA
	Output Leakage Current	$0\text{V} \leq V_{VOUT_ENn} \leq 6\text{V}$	●			± 1	μA
V_{IN_EN} Enable Output (V_{IN_EN}) Characteristics							
V_{VIN_EN}	Output High Voltage	$I_{VIN_EN} = -5\mu\text{A}$, $V_{DD33} = 3.3\text{V}$	●	10	12.5	14.7	V
I_{VIN_EN}	Output Sourcing Current	V_{IN_EN} Pull-Up Enabled, $V_{VIN_EN} = 1\text{V}$	●	-5	-6	-8	μA
	Output Sinking Current	$V_{VIN_EN} = 0.4\text{V}$	●	3	5	8	mA
	Leakage Current	Internal Pull-Up Disabled, $0\text{V} \leq V_{VIN_EN} \leq 15\text{V}$	●			± 1	μA
EEPROM Characteristics							
Endurance	(Notes 10, 11)	$0^\circ\text{C} < T_J < 85^\circ\text{C}$ During EEPROM Write Operations	●	10,000			Cycles
Retention	(Notes 10, 11)	$T_J < 105^\circ\text{C}$	●	20			Years
t_{MASS_WRITE}	Mass Write Operation Time (Note 12)	STORE_USER_ALL, $0^\circ\text{C} < T_J < 85^\circ\text{C}$ During EEPROM Write Operations	●		440	4100	ms
Digital Inputs SCL, SDA, CONTROL0, CONTROL1, WDI/RESETB, FAULTB00, FAULTB01, FAULTB10, FAULTB11, WP							
V_{IH}	High Level Input Voltage		●	2.1			V
V_{IL}	Low Level Input Voltage		●			1.5	V
V_{HYST}	Input Hysteresis				20		mV
I_{LEAK}	Input Leakage Current	$0\text{V} \leq V_{PIN} \leq 5.5\text{V}$, SDA, SCL, CONTROL n Pins Only	●			± 2	μA
		$0\text{V} \leq V_{PIN} \leq V_{DD33} + 0.3\text{V}$, FAULTB zn , WDI/RESETB, WP Pins Only	●			± 2	μA

ELECTRICAL CHARACTERISTICS

The ● denotes the specifications which apply over the full operating temperature range, otherwise specifications are at $T_J = 25^\circ\text{C}$. $V_{PWR} = V_{IN_SNS} = 12\text{V}$, V_{DD33} , V_{DD25} and REF pins floating, unless otherwise indicated. (Notes 2, 3)

SYMBOL	PARAMETER	CONDITIONS	MIN	TYP	MAX	UNITS
t_{SP}	Pulse Width of Spike Suppressed	FAULTBzn, CONTROLn Pins Only		10		μs
		SDA, SCL Pins Only		98		ns
t_{FAULT_MIN}	Minimum Low Pulse Width for Externally Generated Faults		110			ms
t_{RESETB}	Pulse Width to Assert Reset	$V_{WDI/RESETB} \leq 1.5\text{V}$	●	300		μs
t_{WDI}	Pulse Width to Reset Watchdog Timer	$V_{WDI/RESETB} \leq 1.5\text{V}$	●	0.3	200	μs
f_{WDI}	Watchdog Interrupt Input Frequency		●		1	MHz
C_{IN}	Digital Input Capacitance			10		pF

Digital Input SHARE_CLK

V_{IH}	High Level Input Voltage		●	1.6		V
V_{IL}	Low Level Input Voltage		●		0.8	V
$f_{SHARE_CLK_IN}$	Input Frequency Operating Range		●	90	110	kHz
t_{LOW}	Assertion Low Time	$V_{SHARE_CLK} < 0.8\text{V}$	●	0.825	1.1	μs
t_{RISE}	Rise Time	$V_{SHARE_CLK} < 0.8\text{V}$ to $V_{SHARE_CLK} > 1.6\text{V}$	●		450	ns
I_{LEAK}	Input Leakage Current	$0\text{V} \leq V_{SHARE_CLK} \leq V_{DD33} + 0.3\text{V}$	●		± 1	μA
C_{IN}	Input Capacitance			10		pF

Digital Outputs SDA, ALERTB, PWRGD, SHARE_CLK, FAULTB00, FAULTB01, FAULTB10, FAULTB11

V_{OL}	Digital Output Low Voltage	$I_{SINK} = 3\text{mA}$	●		0.4	V	
$f_{SHARE_CLK_OUT}$	Output Frequency Operating Range	5.49k Ω Pull-Up to V_{DD33}	●	90	100	110	kHz

Digital Inputs ASELO,ASEL1

V_{IH}	Input High Threshold Voltage		●	$V_{DD33} - 0.5$		V
V_{IL}	Input Low Threshold Voltage		●		0.5	V
I_{IH}, I_{IL}	High, Low Input Current	$ASEL[1:0] = 0, V_{DD33}$	●		± 95	μA
I_{HIZ}	Hi-Z Input Current		●		± 24	μA
C_{IN}	Input Capacitance			10		pF

Serial Bus Timing Characteristics

f_{SCL}	Serial Clock Frequency (Note 13)		●	10	400	kHz
t_{LOW}	Serial Clock Low Period (Note 13)		●	1.3		μs
t_{HIGH}	Serial Clock High Period (Note 13)		●	0.6		μs
t_{BUF}	Bus Free Time Between Stop and Start (Note 13)		●	1.3		μs
$t_{HD,STA}$	Start Condition Hold Time (Note 13)		●	600		ns
$t_{SU,STA}$	Start Condition Setup Time (Note 13)		●	600		ns
$t_{SU,STO}$	Stop Condition Setup Time (Note 13)		●	600		ns
$t_{HD,DAT}$	Data Hold Time (LTC2980 Receiving Data) (Note 13)		●	0		ns
	Data Hold Time (LTC2980 Transmitting Data) (Note 13)		●	300	900	ns
$t_{SU,DAT}$	Data Setup Time (Note 13)		●	100		ns

ELECTRICAL CHARACTERISTICS

The ● denotes the specifications which apply over the full operating temperature range, otherwise specifications are at $T_J = 25^\circ\text{C}$. $V_{PWR} = V_{IN_SNS} = 12\text{V}$, V_{DD33} , V_{DD25} and REF pins floating, unless otherwise indicated. (Notes 2, 3)

SYMBOL	PARAMETER	CONDITIONS	MIN	TYP	MAX	UNITS
t_{SP}	Pulse Width of Spike Suppressed (Note 13)			98		ns
$t_{TIMEOUT_BUS}$	Time Allowed to Complete any PMBus Command After Which Time SDA Will Be Released and Command Terminated	Mfr_config_all_longer_pmbus_timeout = 0 ● Mfr_config_all_longer_pmbus_timeout = 1 ●		25 200	35 280	ms ms

Additional Digital Timing Characteristics

t_{OFF_MIN}	Minimum Off Time for Any Channel			100		ms
----------------	----------------------------------	--	--	-----	--	----

Note 1: Stresses beyond those listed under Absolute Maximum Ratings may cause permanent damage to the device. Exposure to any Absolute Maximum Rating for extended periods may affect device reliability and lifetime.

Note 2: All currents into device pins are positive. All currents out of device pins are negative. All voltages are referenced to GND unless otherwise specified. If power is supplied to the chip via the V_{DD33} pin only, connect V_{PWR} and V_{DD33} pins together.

Note 3: The LTC2980 electrical characteristics apply to each half of the device, unless otherwise noted. The specifications and functions are the same for both Device A pins and Device B pins.

Note 4: The ADC total unadjusted error includes all error sources. First, a two-point analog trim is performed to achieve a flat reference voltage (V_{REF}) over temperature. This results in minimal temperature coefficient, but the absolute voltage can still vary. To compensate for this, a high-resolution, drift-free, and noiseless digital trim is applied at the output of the ADC, resulting in a very high accuracy measurement.

Note 5: Hysteresis in the output voltage is created by package stress that differs depending on whether the module was previously at a higher or lower temperature. Output voltage is always measured at 25°C , but the module is cycled to 105°C or -40°C before successive measurements. Hysteresis is roughly proportional to the square of the temperature change.

Note 6: The current sense resolution is determined by the L11 format and the mV units of the returned value. For example a full scale value of 170mV returns a L11 value of $0xF2A8 = 680 \cdot 2^{-2} = 170$. This is the lowest range

that can represent this value without overflowing the L11 mantissa and the resolution for 1LSB in this range is $2^{-2} \text{ mV} = 250\mu\text{V}$. Each successively lower range improves resolution by cutting the LSB size in half.

Note 7: The time between successive ADC conversions (latency of the ADC) for any given channel is given as: $36.9\text{ms} + (6.15\text{ms} \cdot \text{number of ADC channels configured in Low Resolution mode}) + (24.6\text{ms} \cdot \text{number of ADC channels configured in High Resolution mode})$.

Note 8: Nonlinearity is defined from the first code that is greater than or equal to the maximum offset specification to full-scale code, 1023.

Note 9: Output enable pins are charge pumped from V_{DD33} .

Note 10: EEPROM endurance and retention are guaranteed by design, characterization and correlation with statistical process controls. The minimum retention specification applies for devices whose EEPROM has been cycled less than the minimum endurance specification.

Note 11: EEPROM endurance and retention will be degraded when $T_J > 105^\circ\text{C}$.

Note 12: The LTC2980 will not acknowledge any PMBus commands while a mass write operation is being executed. This includes the STORE_USER_ALL and MFR_FAULT_LOG_STORE commands or a fault log store initiated by a channel faulting off.

Note 13: Maximum capacitive load, C_B , for SCL and SDA is 400pF. Data and clock rise time (t_r) and fall time (t_f) are:

$$(20 + 0.1 \cdot C_B) \text{ (ns)} < t_r < 300\text{ns} \text{ and } (20 + 0.1 \cdot C_B) \text{ (ns)} < t_f < 300\text{ns}.$$

C_B = capacitance of one bus line in pF. SCL and SDA external pull-up voltage, V_{IO} , is $3.13\text{V} < V_{IO} < 5.5\text{V}$.

PMBUS TIMING DIAGRAM

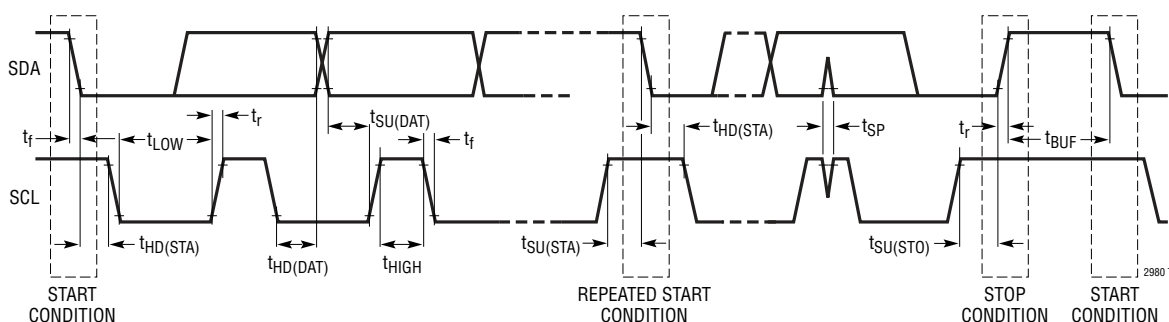

TYPICAL PERFORMANCE CHARACTERISTICS

Reference Voltage vs Temperature

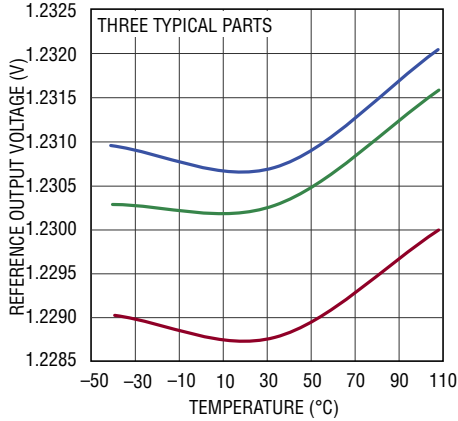

Temperature Sensor Error vs Temperature

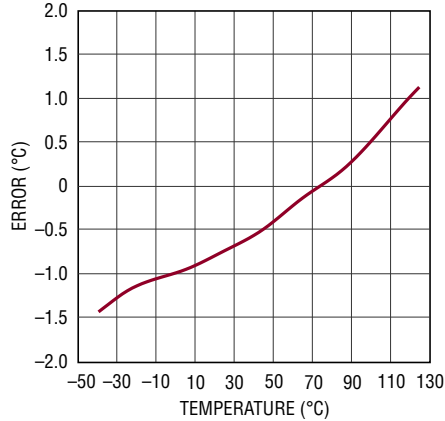

ADC Total Unadjusted Error vs Temperature

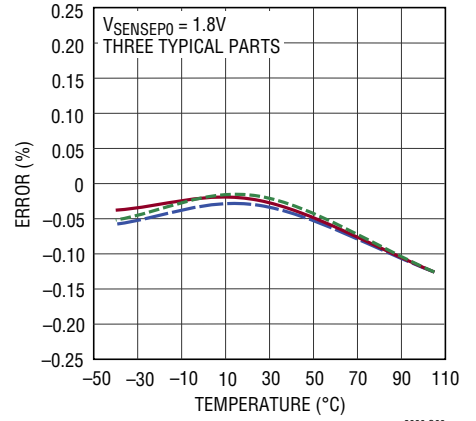

ADC Zero Code Center Offset Voltage vs Temperature

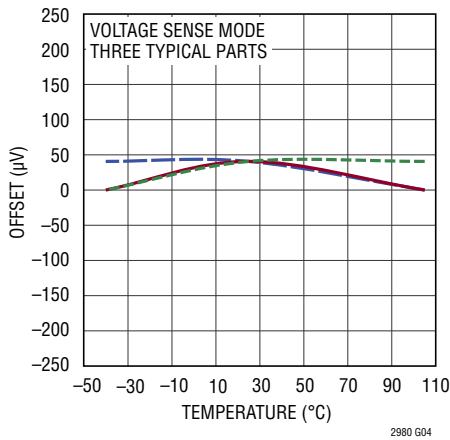

ADC INL

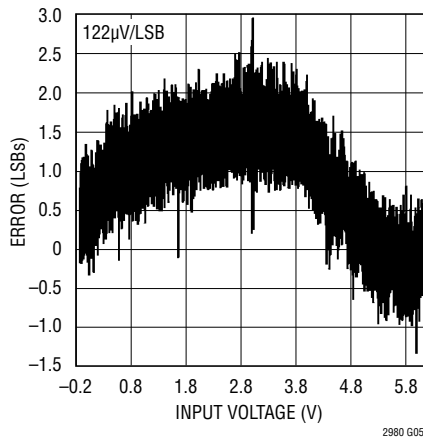

ADC DNL

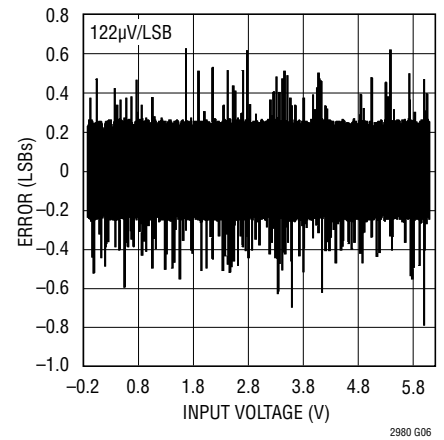

ADC Noise Histogram

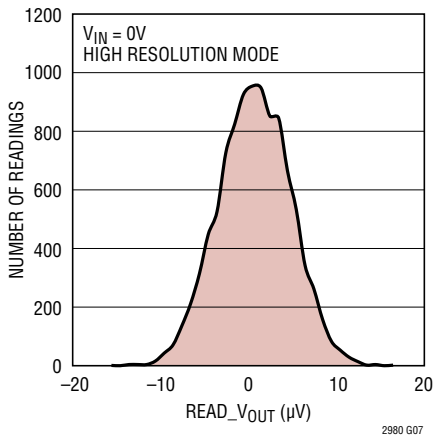

Voltage Supervisor Total Unadjusted Error vs Temperature

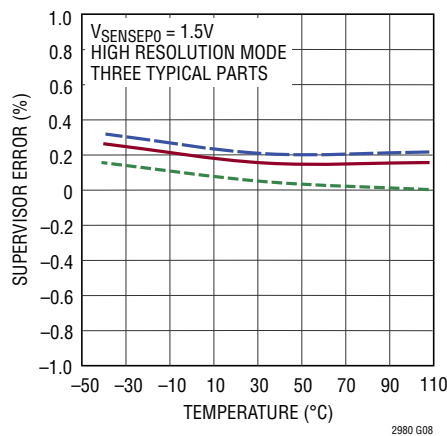

Input Sampling Current vs Differential Input Voltage

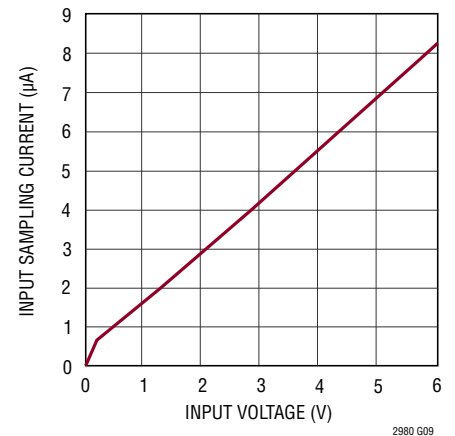

TYPICAL PERFORMANCE CHARACTERISTICS

**ADC High Resolution Mode
Differential Input Current**

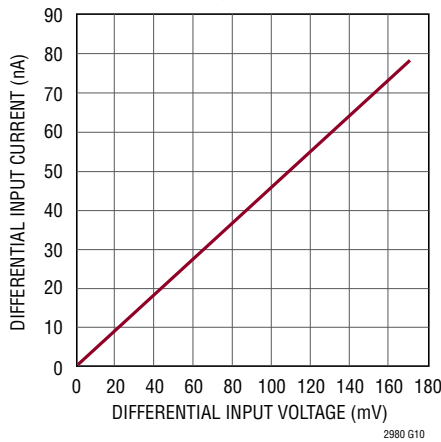

**DAC Full-Scale Output Voltage vs
Temperature**

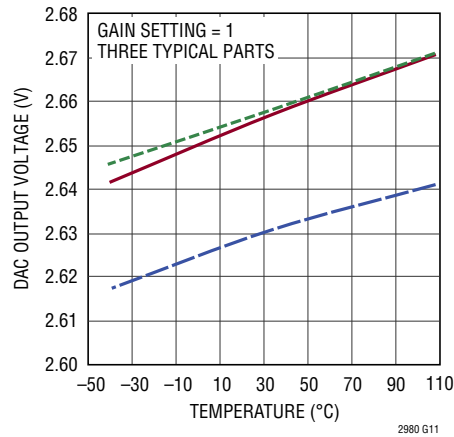

**DAC Offset Voltage vs
Temperature**

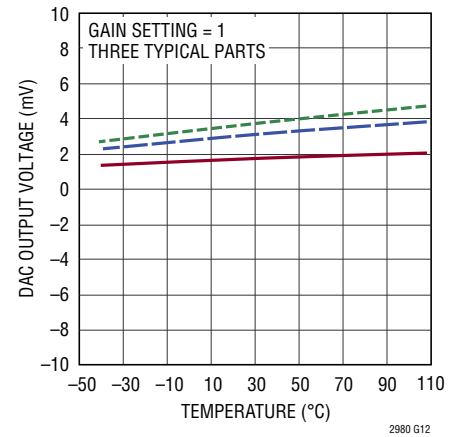

**DAC Short-Circuit Current vs
Temperature**

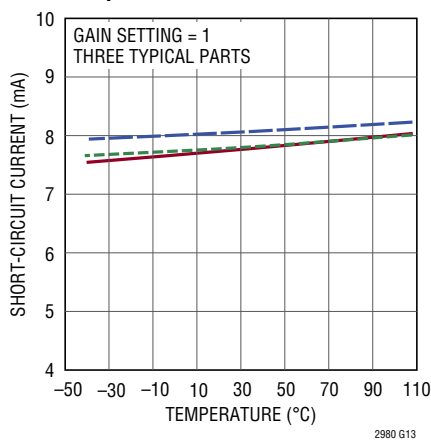

**DAC Output Impedance vs
Frequency**

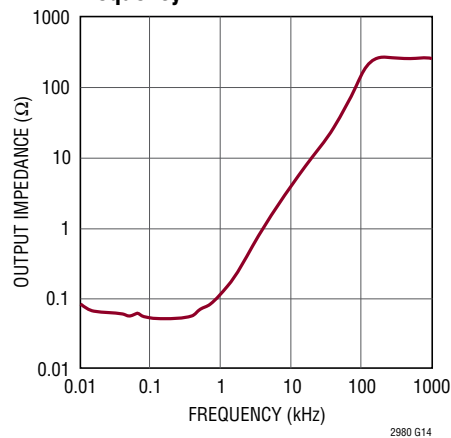

Closed-Loop Servo Error

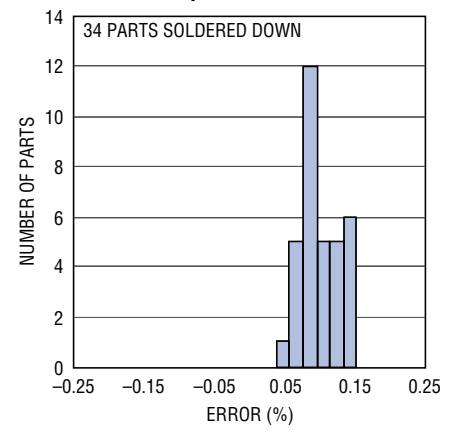

**DAC Transient Response to 1LSB
DAC Code Change**

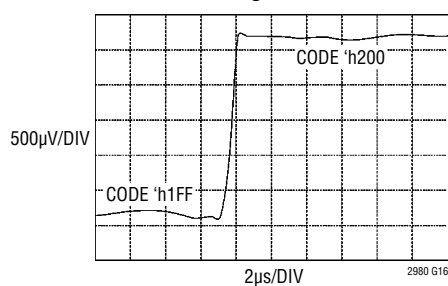

**DAC Soft-Connect Transient
Response When Transitioning
from Hi-Z State to ON State**

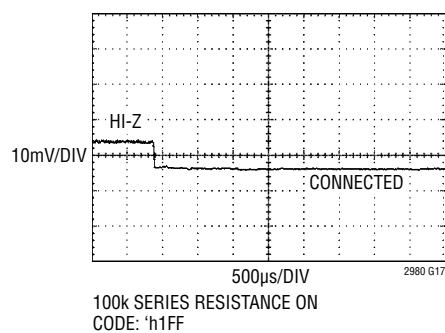

**DAC Soft-Connect Transient
Response When Transitioning
from ON State to Hi-Z State**

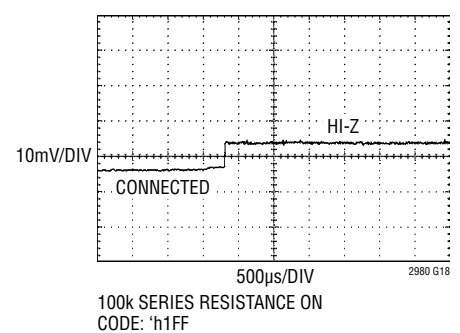

TYPICAL PERFORMANCE CHARACTERISTICS

V_{DD33} Regulator Output Voltage vs Temperature

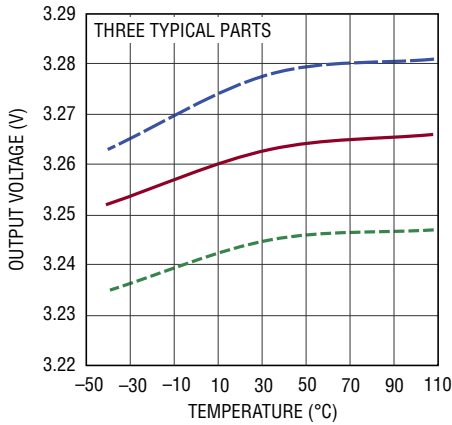

V_{DD33} Regulator Load Regulation

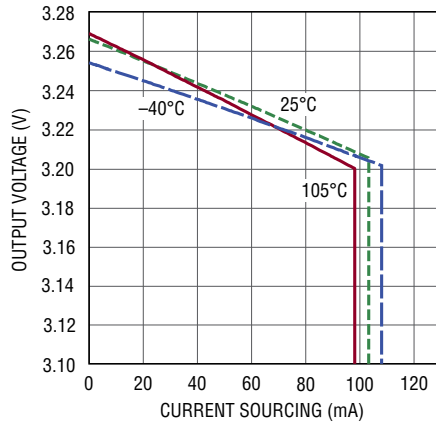

Supply Current vs Supply Voltage (1/2 LTC2980)

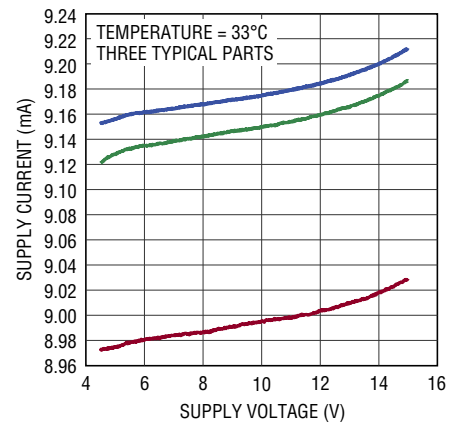

Supply Current vs Temperature (1/2 LTC2980)

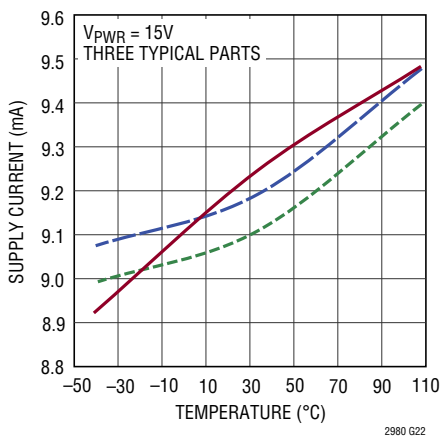

V_{OUT_EN[3:0]} and V_{IN_EN} Output High Voltage vs Current

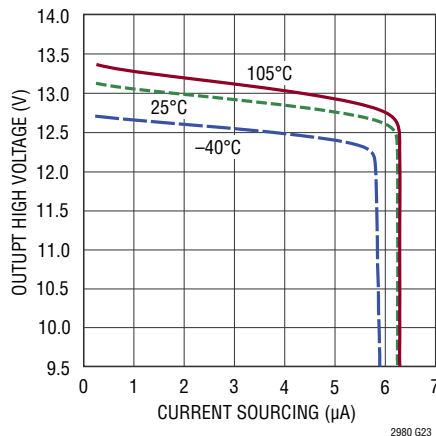

V_{OUT_EN[3:0]} and V_{IN_EN} Output V_{OL} vs Current

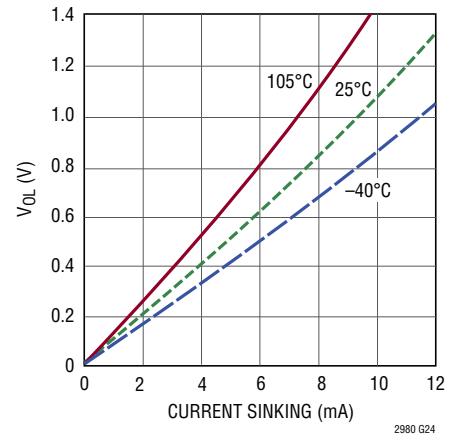

V_{OUT_EN[7:4]} V_{OL} vs Current

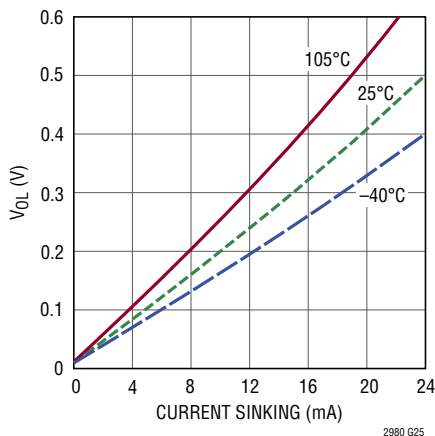

V_{OUT_EN[7:0]} Output Voltage vs V_{DD33}

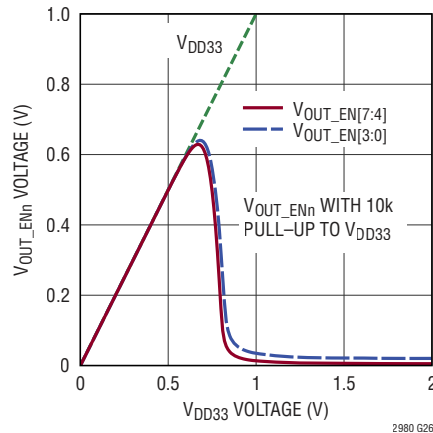

PIN FUNCTIONS

PIN NAME	PIN		PIN TYPE	DESCRIPTION
	Device A	Device B		
V _{SENSE} P0	G5	G11	In	DC/DC Converter Differential (+) Output Voltage-0 Sensing Pin
V _{SENSE} M0	H6	H12	In	DC/DC Converter Differential (-) Output Voltage-0 Sensing Pin
V _{SENSE} P1	E5	E11	In	DC/DC Converter Differential (+) Output Voltage or Current-1 Sensing Pins
V _{SENSE} M1	D6	D12	In	DC/DC Converter Differential (-) Output Voltage or Current-1 Sensing Pins
V _{SENSE} P2	A6	A12	In	DC/DC Converter Differential (+) Output Voltage-2 Sensing Pin
V _{SENSE} M2	A5	A11	In	DC/DC Converter Differential (-) Output Voltage-2 Sensing Pin
V _{SENSE} P3	B5	B11	In	DC/DC Converter Differential (+) Output Voltage or Current-3 Sensing Pins
V _{SENSE} M3	C5	C11	In	DC/DC Converter Differential (-) Output Voltage or Current-3 Sensing Pins
V _{SENSE} P4	B4	B10	In	DC/DC Converter Differential (+) Output Voltage-4 Sensing Pin
V _{SENSE} M4	A4	A10	In	DC/DC Converter Differential (-) Output Voltage-4 Sensing Pin
V _{SENSE} P5	C2	C8	In	DC/DC Converter Differential (+) Output Voltage or Current-5 Sensing Pins
V _{SENSE} M5	B2	B8	In	DC/DC Converter Differential (-) Output Voltage or Current-5 Sensing Pins
V _{SENSE} P6	E2	E8	In	DC/DC Converter Differential (+) Output Voltage-6 Sensing Pin
V _{SENSE} M6	F2	F8	In	DC/DC Converter Differential (-) Output Voltage-6 Sensing Pin
V _{SENSE} P7	A2	A8	In	DC/DC Converter Differential (+) Output Voltage or Current-7 Sensing Pin
V _{SENSE} M7	A1	A7	In	DC/DC Converter Differential (-) Output Voltage or Current-7 Sensing Pin
V _{OUT_EN} 0	B1	B7	Out	DC/DC Converter Enable-0 Pin. Output High Voltage Optionally Pulled Up to 12V by 5 μ A
V _{OUT_EN} 1	C1	C7	Out	DC/DC Converter Enable-1 Pin. Output High Voltage Optionally Pulled Up to 12V by 5 μ A
V _{OUT_EN} 2	D1	D7	Out	DC/DC Converter Enable-2 Pin. Output High Voltage Optionally Pulled Up to 12V by 5 μ A
V _{OUT_EN} 3	J1	J7	Out	DC/DC Converter Enable-3 Pin. Output High Voltage Optionally Pulled Up to 12V by 5 μ A
V _{OUT_EN} 4	H1	H7	Out	DC/DC Converter Enable-4 Pin. Open-Drain Pull-Down Output
V _{OUT_EN} 5	E1	E7	Out	DC/DC Converter Enable-5 Pin. Open-Drain Pull-Down Output
V _{OUT_EN} 6	M1	M7	Out	DC/DC Converter Enable-6 Pin. Open-Drain Pull-Down Output
V _{OUT_EN} 7	L1	L7	Out	DC/DC Converter Enable-7 Pin. Open-Drain Pull-Down Output
V _{IN_EN}	K1	K7	Out	DC/DC Converter V _{IN} ENABLE Pin. Output High Voltage Optionally Pulled Up to 12V by 5 μ A
V _{IN_SNS}	G1	G7	In	V _{IN} SENSE Input. This Voltage is Compared Against the V _{IN} On and Off Voltage Thresholds in Order to Determine When to Enable and Disable, Respectively, the Downstream DC/DC Converters
V _{PWR}	G2	G8	In	V _{PWR} Serves as the Unregulated Power Supply Input to the Chip (4.5V to 15V). If a 4.5V to 15V Supply Voltage is Unavailable, Short V _{PWR} to V _{DD33} and Power the Chip Directly from a 3.3V Supply
V _{DD33}	H2	H8	In/Out	If Shorted to V _{PWR} , it Serves as 3.13V to 3.47V Supply Input Pin. Otherwise it is a 3.3V Internally Regulated Voltage Output. If using the internal regulator to provide V _{DD33} , do not connect to V _{DD33} pins of any other devices
V _{DD33}	J2	J8	In	Input for Internal 2.5V Sub-Regulator. Short Pin J2 to Pin H2 and Pin J8 to Pin H8. If using the internal regulator to provide V _{DD33} , do not connect to V _{DD33} pins of any other devices
V _{DD25}	K2	K8	In/Out	2.5V Internally Regulated Voltage Output. Do not connect to V _{DD25} pins of any other devices
WP	M2	M8	In	Digital Input. Write-Protect Input Pin, Active High
PWRGD	L2	L8	Out	Power Good Open-Drain Output. Indicates When Outputs are Power Good. Can be Used as System Power-On Reset. The Latency of This Signal May Be as Long as the ADC Latency. See Note 7
SHARE_CLK	K3	K9	In/Out	Bidirectional Clock Sharing Pin. Connect a 5.49k Pull-Up Resistor to V _{DD33} . Connect to all other SHARE_CLK pins in the system
WDI/RESETB	L3	L9	In	Watchdog Timer Interrupt and Chip Reset Input. Connect a 10k Pull-Up Resistor to V _{DD33} . Rising Edge Resets Watchdog Counter. Holding This Pin Low for More Than t _{RESETB} Resets the Chip
FAULTB00	M3	M9	In/Out	Open-Drain Output and Digital Input. Active Low Bidirectional Fault Indicator-00. Connect a 10k Pull-Up Resistor to V _{DD33}
FAULTB01	L4	L10	In/Out	Open-Drain Output and Digital Input. Active Low Bidirectional Fault Indicator-01. Connect a 10k Pull-Up Resistor to V _{DD33}

PIN FUNCTIONS

PIN NAME	PIN		PIN TYPE	DESCRIPTION
	Device A	Device B		
FAULTB10	K4	K10	In/Out	Open-Drain Output and Digital Input. Active Low Bidirectional Fault Indicator-10. Connect a 10k Pull-Up Resistor to V_{DD33}
FAULTB11	M4	M10	In/Out	Open-Drain Output and Digital Input. Active Low Bidirectional Fault Indicator-11. Connect a 10k Pull-Up Resistor to V_{DD33}
SDA	M5	M11	In/Out	PMBus Bidirectional Serial Data Pin
SCL	M6	M12	In	PMBus Serial Clock Input Pin (400kHz Maximum)
ALERTB	L5	L11	Out	Open-Drain Output. Generates an Interrupt Request in a Fault/Warning Situation
CONTROL0	L6	L12	In	Control Pin 0 Input
CONTROL1	K6	K12	In	Control Pin 1 Input
ASEL0	K5	K11	In	Ternary Address Select Pin 0 Input. Connect to V_{DD33} , GND or Float to Encode 1 of 3 Logic States
ASEL1	J6	J12	In	Ternary Address Select Pin 1 Input. Connect to V_{DD33} , GND or Float to Encode 1 of 3 Logic States
REFP	J5	J11	Out	Reference Voltage Output
REFM	H5	H11	Out	Reference Return Pin
V_{DACP0}	F6	F12	Out	DAC0 Output
V_{DACM0}	G6	G12	Out	DAC0 Return. Connect to Channel 0 DC/DC Converter's GND Sense or Return to GND
V_{DACP1}	E6	E12	Out	DAC1 Output
V_{DACM1}	F5	F11	Out	DAC1 Return. Connect to Channel 1 DC/DC Converter's GND Sense or Return to GND
V_{DACP2}	C6	C12	Out	DAC2 Output
V_{DACM2}	B6	B12	Out	DAC2 Return. Connect to Channel 2 DC/DC Converter's GND Sense or Return to GND
V_{DACP3}	D5	D11	Out	DAC3 Output
V_{DACM3}	C4	C10	Out	DAC3 Return. Connect to Channel 3 DC/DC Converter's GND Sense or Return to GND
V_{DACP4}	E4	E10	Out	DAC4 Output
V_{DACM4}	D4	D10	Out	DAC4 Return. Connect to Channel 4 DC/DC Converter's GND Sense or Return to GND
V_{DACP5}	A3	A9	Out	DAC5 Output
V_{DACM5}	B3	B9	Out	DAC5 Return. Connect to Channel 5 DC/DC Converter's GND Sense or Return to GND
V_{DACP6}	D3	D9	Out	DAC6 Output
V_{DACM6}	C3	C9	Out	DAC6 Return. Connect to Channel 6 DC/DC Converter's GND Sense or Return to GND
V_{DACP7}	E3	E9	Out	DAC7 Output
V_{DACM7}	D2	D8	Out	DAC7 Return. Connect to Channel 7 DC/DC Converter's GND Sense or Return to GND
GND	F3, F4, G3, G4, H3, H4, J3, J4	F9, F10, G9, G10, H9, H10, J9, J10	Ground	Device A Ground Pins are Isolated from the Device B Ground Pins
DNC	F1	F7	Do Not Connect	Do Not Connect to This Pin

*Any unused $V_{SENSEPN}$ or $V_{SENSEMn}$ or V_{DACMn} pins must be tied to GND.

BLOCK DIAGRAM

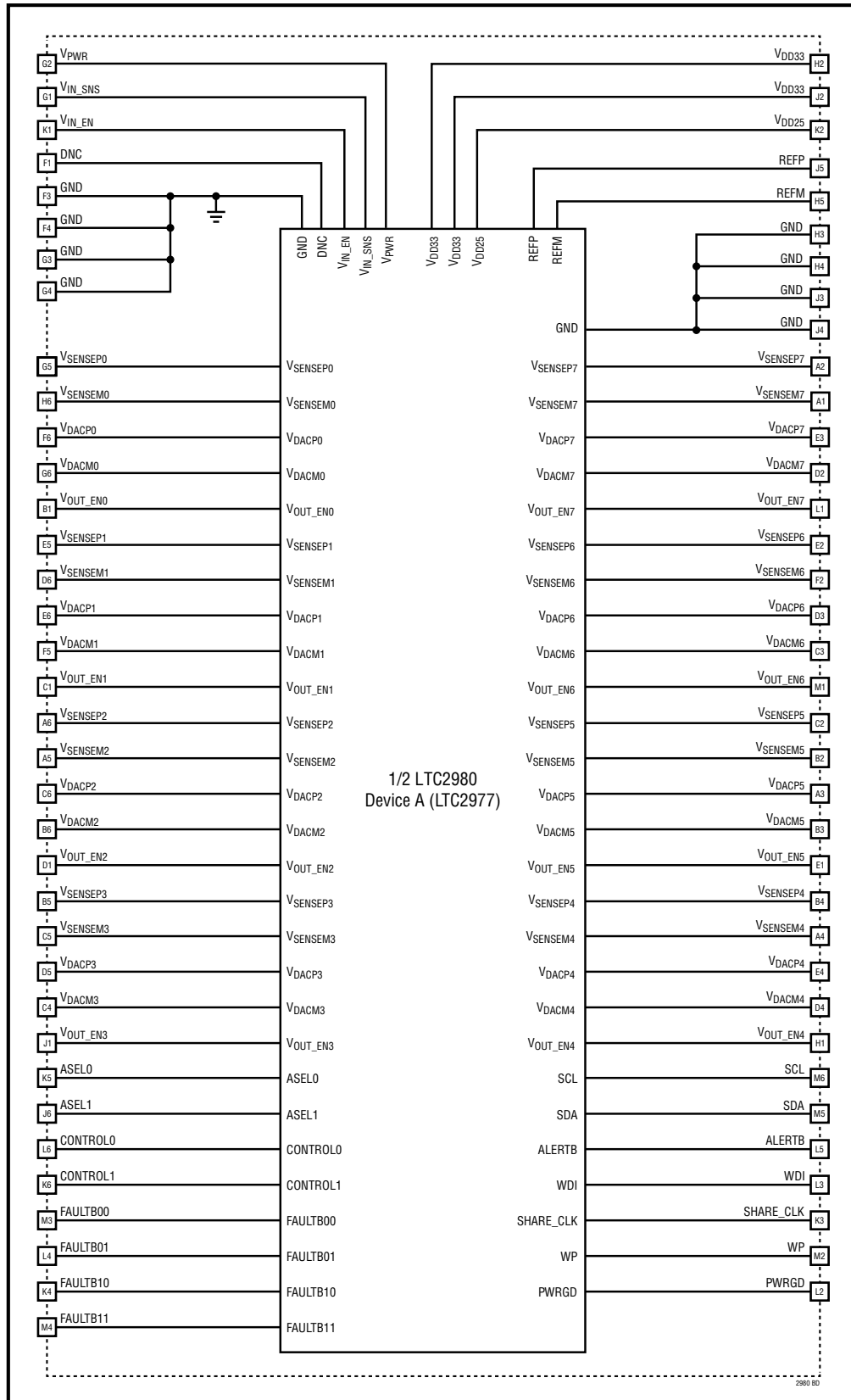

OPERATION

Overview

The LTC2980 contains two independent LTC2977 devices. Each half of the LTC2980 behaves the same as a stand-alone LTC2977 including independent power supply and ground pins.

Refer to the LTC2977 data sheet for a detailed description of the device operation, the PMBus command set, and applications information.

Device Address

Since the LTC2980 consists of two independent LTC2977 devices, each half of the LTC2980 must be configured for a unique address. The I²C/SMBus addresses of the LTC2980 are configured in the same manner as for individual LTC2977 devices. The LTC2980 also responds to

the LTC2977 global address and the SMBus alert response address, regardless of the state of the ASEL pins and the MFR_I2C_BASE_ADDRESS register. Please refer to the Device Address section in the LTC2977 data sheet for more details.

MFR_SPECIAL_ID

The LTC2980 contains unique MFR_SPECIAL_ID values to differentiate it from the LTC2977. Table 1 lists the MFR_SPECIAL_ID values for the LTC2980.

Table 1. LTC2980 MFR_SPECIAL_ID Values

LTC2980 DEVICE	MFR_SPECIAL_ID
Device A	0x8031
Device B	0x8041

APPLICATIONS INFORMATION

OVERVIEW

The LTC2980 is a digital power system manager that is capable of sequencing, margining, trimming, supervising output voltage for OV/UV conditions, providing fault management, and voltage readback for sixteen DC/DC converters. Input voltage and LTC2980 junction temperature readback are also available. Odd numbered channels can be configured to read back current sense resistor voltages. Multiple LTC2980s can be synchronized to operate in unison using the SHARE_CLK, FAULTB and CONTROL pins. The LTC2980 utilizes a PMBus compliant interface and command set.

POWERING THE LTC2980

The LTC2980 can be powered two ways. The first method requires that a voltage between 4.5V and 15V be applied to the V_{PWR} pin. See Figure 1. Internal linear regulators convert V_{PWR} down to 3.3V which drives all of the internal circuitry in each device. Do not tie the V_{DD33(A)} and V_{DD33(B)} pins together since each half of the LTC2980 has independent voltage regulators.

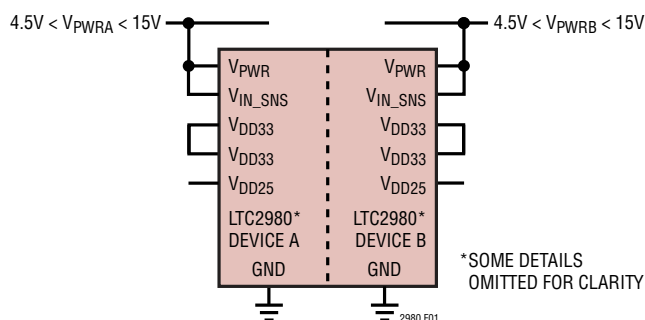

Figure 1. Powering LTC2980 Directly from an Intermediate Bus

APPLICATIONS INFORMATION

Alternatively, power from an external 3.3V supply may be applied directly to the V_{DD33} pins using a voltage between 3.13V and 3.47V. Tie V_{PWR} to the V_{DD33} pins. See Figure 2. In this case, $V_{DD33(A)}$ and $V_{DD33(B)}$ may be tied together. All functionality is available when using this alternate power method. The higher voltages needed for the $V_{OUT_EN[0:3]}$ pins and bias for the V_{SENSE} pins are charge pumped from V_{DD33} .

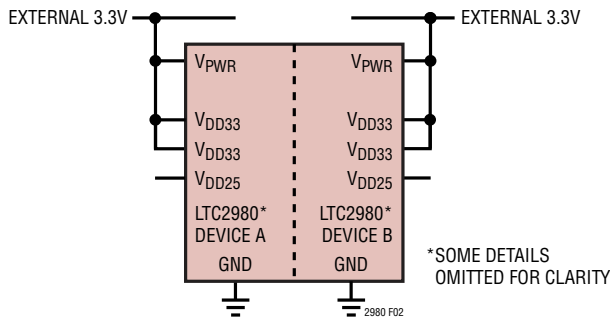

Figure 2. Powering LTC2980 from External 3.3V Supply

The method used to power each device in the LTC2980 is independent of the other device. Either method may be used in any combination.

APPLICATION CIRCUITS

V_{IN} Sense

Voltages other than V_{IN} can be monitored and supervised using the V_{IN_SNS} pins. Each V_{IN_SNS} pin has a calibrated internal divider allowing it to directly sense voltages up to 15V.

Unused ADC Sense Inputs

Connect all unused ADC sense inputs (V_{SENSEn} or V_{SENSEm}) to GND. In a system where the inputs are connected to removable cards and may be left floating in certain situations, connect the inputs to GND using 100k resistors, as shown in Figure 3.

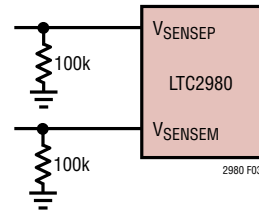

Figure 3. Undedicated Pull-Up Resistors

PCB ASSEMBLY AND LAYOUT SUGGESTIONS

Bypass Capacitor Placement

The LTC2980 requires 0.1 μ F bypass capacitors between the V_{DD33} pins and GND, the V_{DD25} pins and GND, and between the REFP and REFM pins. If the chip is being powered from the V_{PWR} input, then that pin should also be bypassed to GND by a 0.1 μ F capacitor. In order to be effective, these capacitors should be made of high quality ceramic dielectric such as X5R or X7R and be placed as close to the chip as possible. The PCB layout should adhere to good layout guidelines. A multilayer PCB that dedicates a layer to power and ground is recommended. Low resistance and low inductance power and ground connections are important to minimize power supply noise and ensure proper device operation.

DESIGN CHECKLIST

I^2C

- Each half of the LTC2980 must be configured for a unique address. Unique hardware ASELn values are recommended for simplest in system programming.
- The address select pins (ASELn) are tri-level; Check Table 1 of the LTC2977 data sheet.
- Check addresses for collision with other devices on the bus and any global addresses.

APPLICATIONS INFORMATION

Output Enables

- Use appropriate pull-up resistors on all V_{OUT_ENn} pins.
- Verify that the absolute maximum ratings of the V_{OUT_ENn} pins are not exceeded.

V_{IN} Sense

- No external resistive divider is required to sense V_{IN} ; V_{IN_SNS} already has an internal calibrated divider.

Logic Signals

- Verify the absolute maximum ratings of the digital pins (SCL, SDA, ALERTB, FAULTB zn , CONTROL n , SHARE_CLK, WDI, ASEL n , PWRGD) are not exceeded.
- Connect all SHARE_CLK pins in the system together and pull up to 3.3V with a 5.49k resistor.
- Do not leave CONTROL n pins floating. Pull up to 3.3V with a 10k resistor.
- Tie WDI/RESETB to V_{DD33} with a 10k resistor. Do not connect a capacitor to the WDI/RESETB pin.
- Tie WP to either VDD33 or GND. Do not leave floating.

Unused Inputs

- Connect all unused V_{SENSEp_n} , V_{SENSEM_n} and DACM n pins to GND. Do not float unused inputs. Refer to Unused ADC Sense Inputs in the Applications Information section of the LTC2977 data sheet

DAC Outputs

- Select appropriate resistor for desired margin range. Refer to the resistor selection tool in LTpowerPlay for assistance.

Power Supplies

- If powered from V_{PWR} , do not connect the $V_{DD33(A)}$ and $V_{DD33(B)}$ pins together. Each V_{DD33} pin has an independent, internal regulator.

For a more complete list of design considerations and a schematic checklist, see the Design Checklist on the LTC2980 product page:

www.linear.com/LTC2980

PACKAGE DESCRIPTION

LTC2980 Component BGA Pinout (Top View)

	DEVICE A						DEVICE B					
	1	2	3	4	5	6	7	8	9	10	11	12
A	$V_{SENSEM7}$	$V_{SENSEP7}$	V_{DACP5}	$V_{SENSEM4}$	$V_{SENSEM2}$	$V_{SENSEP2}$	$V_{SENSEM7}$	$V_{SENSEP7}$	V_{DACP5}	$V_{SENSEM4}$	$V_{SENSEM2}$	$V_{SENSEP2}$
B	V_{OUT_EN0}	$V_{SENSEM5}$	V_{DACM5}	$V_{SENSEP4}$	$V_{SENSEP3}$	V_{DACM2}	V_{OUT_EN0}	$V_{SENSEM5}$	V_{DACM5}	$V_{SENSEP4}$	$V_{SENSEP3}$	V_{DACM2}
C	V_{OUT_EN1}	$V_{SENSEP5}$	V_{DACM6}	V_{DACM3}	$V_{SENSEM3}$	V_{DACP2}	V_{OUT_EN1}	$V_{SENSEP5}$	V_{DACM6}	V_{DACM3}	$V_{SENSEM3}$	V_{DACP2}
D	V_{OUT_EN2}	V_{DACM7}	V_{DACP6}	V_{DACM4}	V_{DACP3}	$V_{SENSEM1}$	V_{OUT_EN2}	V_{DACM7}	V_{DACP6}	V_{DACM4}	V_{DACP3}	$V_{SENSEM1}$
E	V_{OUT_EN5}	$V_{SENSEP6}$	V_{DACP7}	V_{DACP4}	$V_{SENSEP1}$	V_{DACP1}	V_{OUT_EN5}	$V_{SENSEP6}$	V_{DACP7}	V_{DACP4}	$V_{SENSEP1}$	V_{DACP1}
F	DNC	$V_{SENSEM6}$	GND	GND	V_{DACM1}	V_{DACP0}	DNC	$V_{SENSEM6}$	GND	GND	V_{DACM1}	V_{DACP0}
G	V_{IN_SNS}	V_{PWR}	GND	GND	$V_{SENSEP0}$	V_{DACM0}	V_{IN_SNS}	V_{PWR}	GND	GND	$V_{SENSEP0}$	V_{DACM0}
H	V_{OUT_EN4}	V_{DD33}	GND	GND	REFM	$V_{SENSEM0}$	V_{OUT_EN4}	V_{DD33}	GND	GND	REFM	$V_{SENSEM0}$
J	V_{OUT_EN3}	V_{DD33}	GND	GND	REFP	ASEL1	V_{OUT_EN3}	V_{DD33}	GND	GND	REFP	ASEL1
K	V_{IN_EN}	V_{DD25}	SHARE_CLK	FAULTB10	ASEL0	CONTROL1	V_{IN_EN}	V_{DD25}	SHARE_CLK	FAULTB10	ASEL0	CONTROL1
L	V_{OUT_EN7}	PWRGD	WDI	FAULTB01	ALERTB	CONTROL0	V_{OUT_EN7}	PWRGD	WDI	FAULTB01	ALERTB	CONTROL0
M	V_{OUT_EN6}	WP	FAULTB00	FAULTB11	SDA	SCL	V_{OUT_EN6}	WP	FAULTB00	FAULTB11	SDA	SCL

PACKAGE DESCRIPTION

Please refer to <http://www.linear.com/product/LTC2980#packaging> for the most recent package drawings.

BGA Package
144-Lead (12mm × 12mm × 1.29mm)
 (Reference LTC DWG # 05-08-1967 Rev 0)
 (Y144AH)

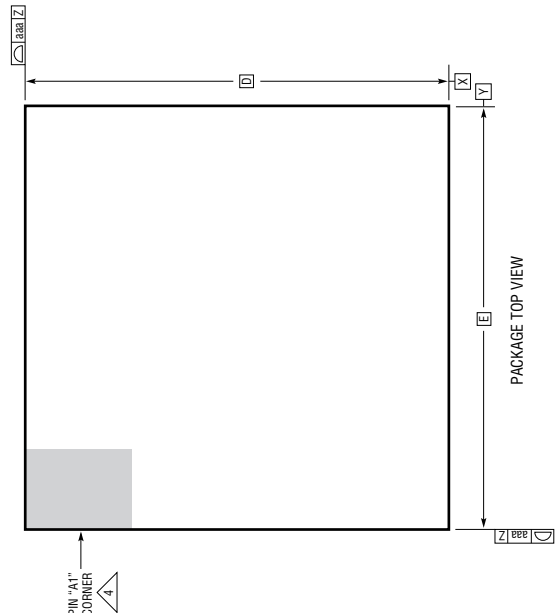
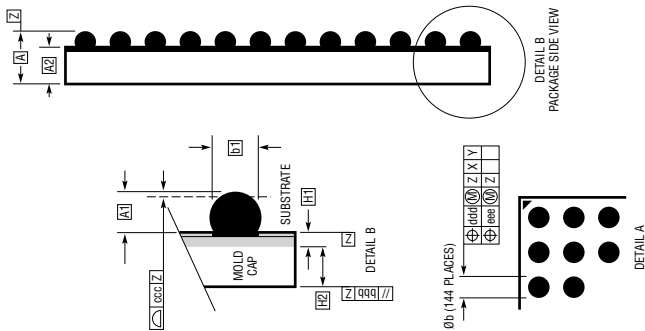
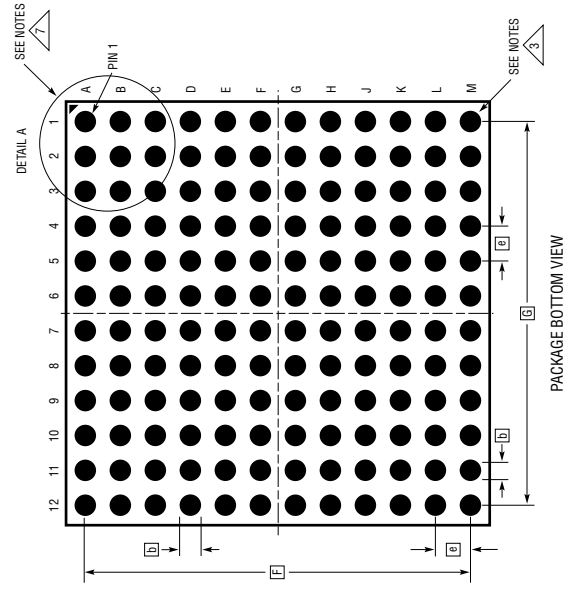

- NOTES:**
1. DIMENSIONING AND TOLERANCING PER ASME Y14.5M-1994
 2. ALL DIMENSIONS ARE IN MILLIMETERS. DRAWING NOT TO SCALE
 3. BALL DESIGNATION PER JEDEC MS-028 AND JEP95
 4. DETAILS OF PIN #1 IDENTIFIER ARE OPTIONAL BUT MUST BE LOCATED WITHIN THE ZONE INDICATED. THE PIN #1 IDENTIFIER MAY BE EITHER A MOLD OR MARKED FEATURE
 5. PRIMARY DATUM - Z - IS SEATING PLANE
 6. SOLDER BALL COMPOSITION IS 96.5% Sn/3.0% Ag/0.5% Cu
 7. PACKAGE ROW AND COLUMN LABELING MAY VARY AMONG PRODUCTS. REVIEW EACH PACKAGE LAYOUT CAREFULLY

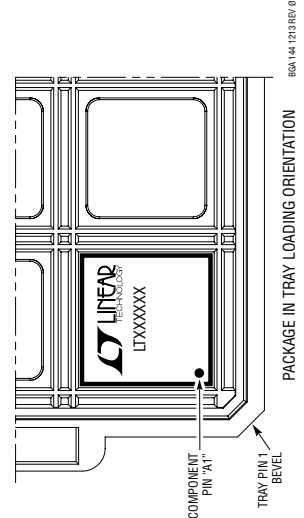

DIMENSIONS		MIN	NOM	MAX	NOTES
SYMBOL					
A		1.24	1.29	1.34	
A1		0.27	0.32	0.37	
A2		0.92	0.97	1.02	
b		0.35	0.40	0.45	
b1		0.30	0.35	0.40	
D			12.00		
E			12.00		
e			1.00		
F			11.00		
G			11.00		
H1		0.22	0.27	0.32	
H2		0.65	0.70	0.75	
aaa				0.15	
bbb				0.10	
ccc				0.12	
ddd				0.15	
eee				0.08	
					TOTAL NUMBER OF BALLS: 144

REVISION HISTORY

REV	DATE	DESCRIPTION	PAGE NUMBER
A	08/17	Added EEPROM ECC information and updated Typical Application.	1
		Updated DAC Output Update Rate (t_{S_VDACP}).	4
		Added graph: $V_{OUT_EN(7:0)}$ Output Voltage vs V_{DD33}	10
		Updated MFR_SPECIAL_ID in Table 1	15

TYPICAL APPLICATION

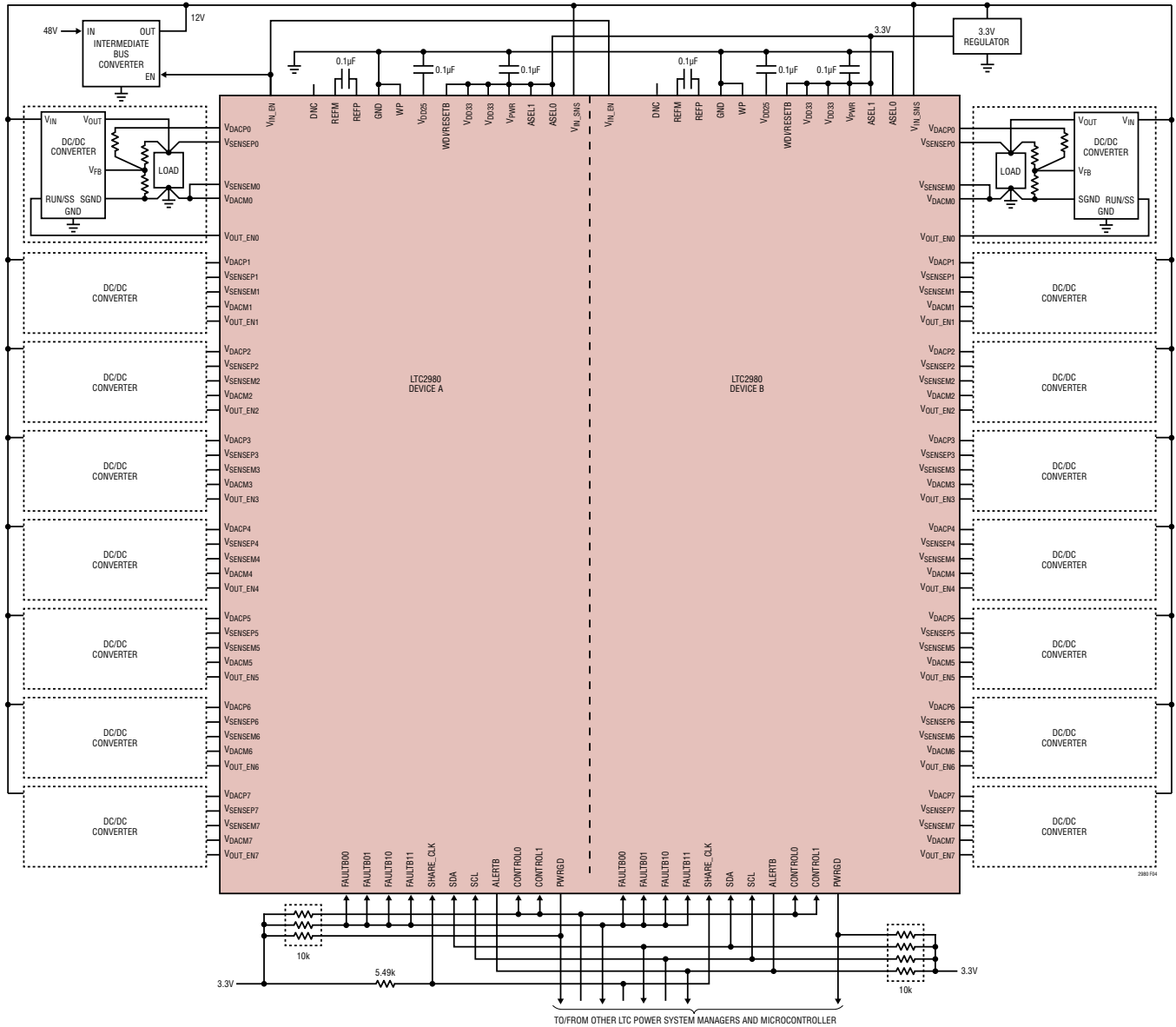

Figure 4. LTC2980 16-Channel Application Circuit with External 3.3V Chip Power

RELATED PARTS

PART NUMBER	DESCRIPTION	COMMENTS
LTC2970	Dual I ² C Power Supply Monitor and Margining Controller	5V to 15V, 0.5% TUE 14-Bit ADC, 8-Bit DAC, Temperature Sensor
LTC2974	4-Channel PMBus Power System Manager	0.25% TUE 16-Bit ADC, Voltage/Current/Temperature Monitoring and Supervision
LTC2975	4-Channel PMBus Power System Manager	0.25% TUE 16-Bit ADC, Voltage/Current/Temperature Monitoring and Supervision, Input Current and Power, Input Energy Accumulator
LTC2977	8-Channel PMBus Power System Manager	0.25% TUE 16-Bit ADC, Voltage/Temperature Monitoring and Supervision
LTM [®] 2987	16-Channel μModule PMBus Power System Manager	Dual LTC2977 with Integrated Passive Components
LTC3880	Dual Output PolyPhase Step-Down DC/DC Controller	0.5% TUE 16-Bit ADC, Voltage/Current/Temperature Monitoring and Supervision
LTC3883	Single Output PolyPhase Step-Down DC/DC Controller	0.5% TUE 16-Bit ADC, Voltage/Current/Temperature Monitoring and Supervision

2980fa