

RF Power Field Effect Transistors

N-Channel Enhancement-Mode Lateral MOSFETs

Designed for broadband commercial and industrial applications with frequencies up to 1000 MHz. The high gain and broadband performance of these devices make them ideal for large-signal, common-source amplifier applications in 28 volt base station equipment.

- Typical Single-Carrier N-CDMA Performance: $V_{DD} = 28$ Volts, $I_{DQ} = 1400$ mA, $P_{out} = 40$ Watts Avg., $f = 880$ MHz, IS-95 CDMA (Pilot, Sync, Paging, Traffic Codes 8 Through 13). Channel Bandwidth = 1.2288 MHz, PAR = 9.8 dB @ 0.01% Probability on CCDF.
Power Gain — 20.8 dB
Drain Efficiency — 31.3%
Device Output Signal PAR — 8.1 dB @ 0.01% Probability on CCDF
ACPR @ 750 kHz Offset — -46.5 dBc in 30 kHz Channel Bandwidth
- Capable of Handling 10:1 VSWR, @ 32 Vdc, 880 MHz, $P_{out} = 270$ W CW (2 dB Input Overdrive from Rated P_{out}), Designed for Enhanced Ruggedness

Features

- 100% PAR Tested for Guaranteed Output Power Capability
- Characterized with Series Equivalent Large-Signal Impedance Parameters
- Internally Matched for Ease of Use
- Greater Negative Gate-Source Voltage Range for Improved Class C Operation
- Qualified Up to a Maximum of 32 V_{DD} Operation
- Integrated ESD Protection
- RoHS Compliant
- In Tape and Reel. R3 Suffix = 250 Units per 56 mm, 13 inch Reel.

MRFE6S9201HR3
MRFE6S9201HSR3

880 MHz, 40 W AVG., 28 V
SINGLE N-CDMA
LATERAL N-CHANNEL
RF POWER MOSFETs

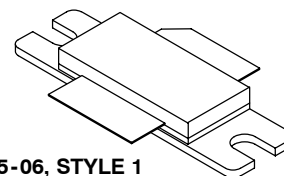

CASE 465-06, STYLE 1
NI-780
MRFE6S9201HR3

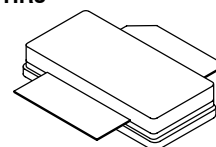

CASE 465A-06, STYLE 1
NI-780S
MRFE6S9201HSR3

Table 1. Maximum Ratings

Rating	Symbol	Value	Unit
Drain-Source Voltage	V_{DSS}	-0.5, +66	Vdc
Gate-Source Voltage	V_{GS}	-6.0, +10	Vdc
Storage Temperature Range	T_{stg}	-65 to +150	°C
Case Operating Temperature	T_C	150	°C
Operating Junction Temperature (1,2)	T_J	225	°C

Table 2. Thermal Characteristics

Characteristic	Symbol	Value (2,3)	Unit
Thermal Resistance, Junction to Case	$R_{\theta JC}$		°C/W
Case Temperature 85°C, 197 W CW		0.34	
Case Temperature 75°C, 40 W CW		0.33	

1. Continuous use at maximum temperature will affect MTTF.
2. MTTF calculator available at <http://www.freescale.com/rf>. Select Software & Tools/Development Tools/Calculators to access MTTF calculators by product.
3. Refer to AN1955, *Thermal Measurement Methodology of RF Power Amplifiers*. Go to <http://www.freescale.com/rf>. Select Documentation/Application Notes - AN1955.

Table 3. ESD Protection Characteristics

Test Methodology	Class
Human Body Model (per JESD22-A114)	1B (Minimum)
Machine Model (per EIA/JESD22-A115)	A (Minimum)
Charge Device Model (per JESD22-C101)	IV (Minimum)

Table 4. Electrical Characteristics ($T_C = 25^\circ\text{C}$ unless otherwise noted)

Characteristic	Symbol	Min	Typ	Max	Unit
Off Characteristics					
Zero Gate Voltage Drain Leakage Current ($V_{DS} = 66\text{ Vdc}$, $V_{GS} = 0\text{ Vdc}$)	I_{DSS}	—	—	10	μAdc
Zero Gate Voltage Drain Leakage Current ($V_{DS} = 28\text{ Vdc}$, $V_{GS} = 0\text{ Vdc}$)	I_{DSS}	—	—	1	μAdc
Gate-Source Leakage Current ($V_{GS} = 5\text{ Vdc}$, $V_{DS} = 0\text{ Vdc}$)	I_{GSS}	—	—	10	μAdc

On Characteristics

Gate Threshold Voltage ($V_{DS} = 10\text{ Vdc}$, $I_D = 400\ \mu\text{Adc}$)	$V_{GS(th)}$	1.5	2.2	3	Vdc
Gate Quiescent Voltage ($V_{DD} = 28\text{ Vdc}$, $I_D = 1400\ \text{mAdc}$, Measured in Functional Test)	$V_{GS(Q)}$	2.25	2.9	3.75	Vdc
Drain-Source On-Voltage ($V_{GS} = 10\text{ Vdc}$, $I_D = 4.11\ \text{Adc}$)	$V_{DS(on)}$	0.1	0.21	0.35	Vdc

Dynamic Characteristics ⁽¹⁾

Reverse Transfer Capacitance ($V_{DS} = 28\text{ Vdc} \pm 30\ \text{mV(rms)ac}$ @ 1 MHz, $V_{GS} = 0\text{ Vdc}$)	C_{rss}	—	2.3	—	pF
Output Capacitance ($V_{DS} = 28\text{ Vdc} \pm 30\ \text{mV(rms)ac}$ @ 1 MHz, $V_{GS} = 0\text{ Vdc}$)	C_{oss}	—	90	—	pF
Input Capacitance ($V_{DS} = 28\text{ Vdc}$, $V_{GS} = 0\text{ Vdc} \pm 30\ \text{mV(rms)ac}$ @ 1 MHz)	C_{iss}	—	480	—	pF

Functional Tests (In Freescale Test Fixture, 50 ohm system) $V_{DD} = 28\text{ Vdc}$, $I_{DQ} = 1400\ \text{mA}$, $P_{out} = 40\ \text{W Avg}$. N-CDMA, $f = 880\ \text{MHz}$, Single-Carrier N-CDMA, 1.2288 MHz Channel Bandwidth Carrier. ACPR measured in 30 kHz Channel Bandwidth @ $\pm 750\ \text{kHz}$ Offset. PAR = 9.8 dB @ 0.01% Probability on CCDF.

Power Gain	G_{ps}	19.5	20.8	22.5	dB
Drain Efficiency	η_D	29	31.3	—	%
Output Peak-to-Average Ratio @ 0.01% Probability on CCDF	PAR	7.7	8.1	—	dB
Adjacent Channel Power Ratio	ACPR	—	-46.5	-45	dBc
Input Return Loss	IRL	—	-16	-9	dB

1. Part is internally matched on input.

(continued)

Table 4. Electrical Characteristics ($T_C = 25^\circ\text{C}$ unless otherwise noted) (continued)

Characteristic	Symbol	Min	Typ	Max	Unit
Typical Performances (In Freescale Test Fixture, 50 ohm system) $V_{DD} = 28\text{ Vdc}$, $I_{DQ} = 1400\text{ mA}$, 865-900 MHz Bandwidth					
Video Bandwidth @ 200 W PEP P_{out} where $IM3 = -30\text{ dBc}$ (Tone Spacing from 100 kHz to VBW) $\Delta IMD3 = IMD3 @ \text{VBW frequency} - IMD3 @ 100\text{ kHz} < 1\text{ dBc}$ (both sidebands)	VBW	—	10	—	MHz
Gain Flatness in 35 MHz Bandwidth @ $P_{out} = 40\text{ W Avg.}$	G_F	—	0.19	—	dB
Average Deviation from Linear Phase in 35 MHz Bandwidth @ $P_{out} = 200\text{ W CW}$	Φ	—	0.461	—	°
Average Group Delay @ $P_{out} = 200\text{ W CW}$, $f = 880\text{ MHz}$	Delay	—	11.66	—	ns
Part-to-Part Insertion Phase Variation @ $P_{out} = 200\text{ W CW}$, $f = 880\text{ MHz}$, Six Sigma Window	$\Delta\Phi$	—	14.97	—	°
Gain Variation over Temperature (-30°C to $+85^\circ\text{C}$)	ΔG	—	0.011	—	dB/°C
Output Power Variation over Temperature (-30°C to $+85^\circ\text{C}$)	ΔP_{1dB}	—	0.39	—	dBm/°C

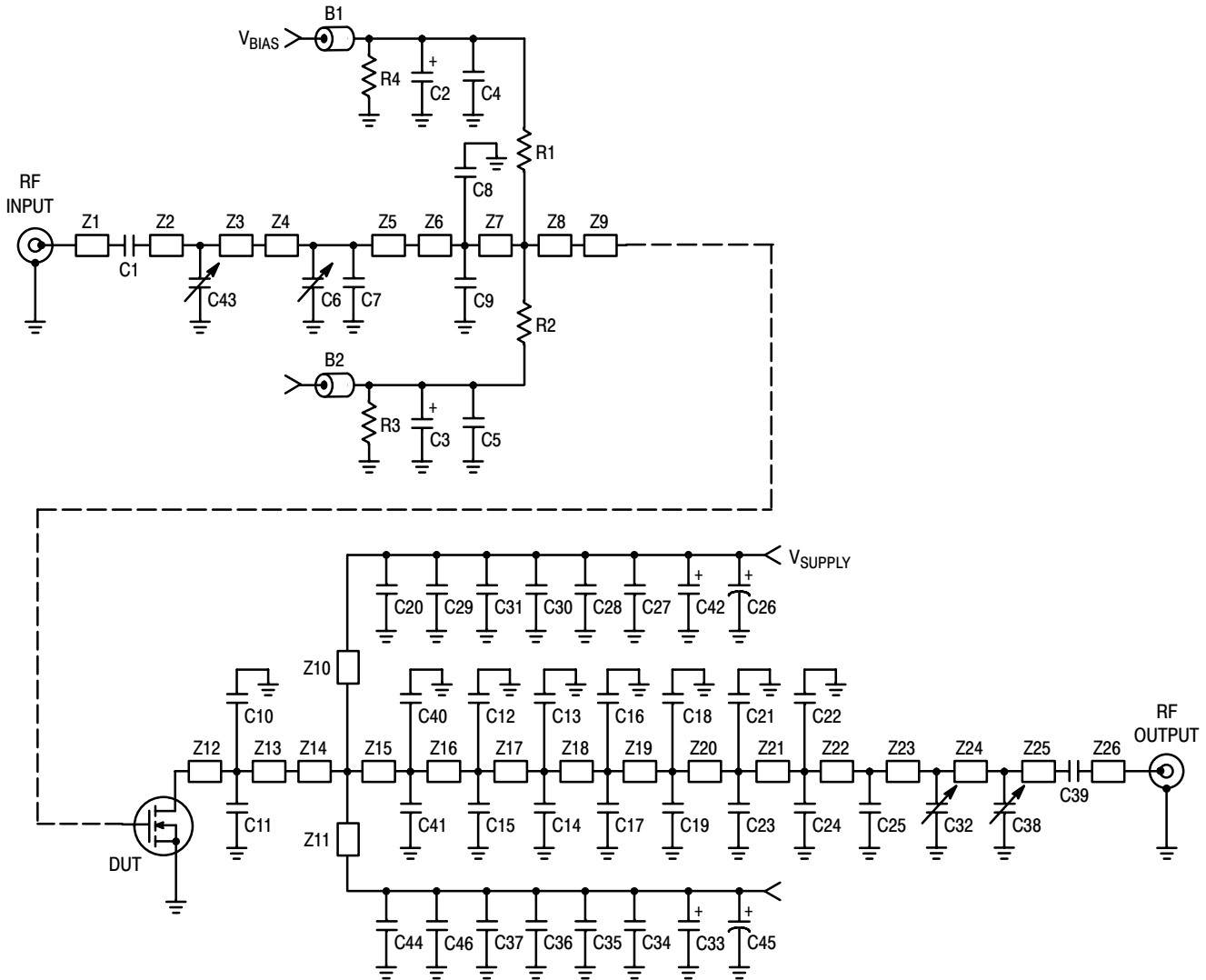

Z1	0.227" x 0.065" Microstrip	Z10, Z11	0.853" x 0.100" Microstrip	Z19	0.020" x 0.365" Microstrip
Z2	0.938" x 0.065" Microstrip	Z12	0.084" x 0.780" Microstrip	Z20	0.097" x 0.065" Microstrip
Z3	0.492" x 0.065" Microstrip	Z13	0.086" x 0.780" Microstrip	Z21, Z22	0.050" x 0.065" Microstrip
Z4	0.046" x 0.300" Microstrip	Z14	0.035" x 0.780" x 0.709" Taper	Z23	0.305" x 0.065" Microstrip
Z5	0.094" x 0.300" Microstrip	Z15	0.093" x 0.709" x 0.499" Taper	Z24	0.456" x 0.065" Microstrip
Z6	0.141" x 0.546" x 0.300" Taper	Z16	0.131" x 0.499" x 0.286" Taper	Z25	0.357" x 0.065" Microstrip
Z7	0.076" x 0.734" x 0.546" Taper	Z17	0.047" x 0.365" Microstrip	Z26	0.340" x 0.065" Microstrip
Z8	0.023" x 0.780" x 0.734" Taper	Z18	0.054" x 0.365" Microstrip	PCB	Taconic RF-35, 0.030", $\epsilon_r = 3.5$
Z9	0.170" x 0.780" Microstrip				

Figure 1. MRFE6S9201HR3(HSR3) Test Circuit Schematic

Table 5. MRFE6S9201HR3(HSR3) Test Circuit Component Designations and Values

Part	Description	Part Number	Manufacturer
B1, B2	Short RF Beads	2743019447ROP50	Fair-Rite
C1, C4, C5, C20, C39, C44	33 pF Chip Capacitors	ATC100B330JT500XT	ATC
C2, C3	10 μ F, 50 V Tantalum Capacitors	T491C106K050AT	Kemet
C6, C32, C38, C43	0.6 - 4.5 pF Variable Capacitors, Gigatrim	27271SL	Johanson
C7, C12, C13, C14, C15, C16, C17, C25	3.3 pF Chip Capacitors	ATC600F3R3BT250XT	ATC
C8, C9	4.7 pF Chip Capacitors	ATC600F4R7BT250XT	ATC
C10, C11	15 pF Chip Capacitors	ATC100B6R8JT500XT	ATC
C18, C19, C21, C22, C23, C24	1.0 pF Chip Capacitors	ATC600F1R0BT250XT	ATC
C26, C45	470 μ F, 63 V Electrolytic Capacitors	EKMG630ELL331MJ20S	United Chemi-Con
C27, C34	1.2K pF Chip Capacitors	ATC100B1R2BT500XT	ATC
C28, C35	20K pF Chip Capacitors	ATC200B203MT50XT	ATC
C29, C31, C37, C46	10 μ F, 50 V Chip Capacitors	GRM55DR61H106KA88B	Murata
C30, C36	0.047 pF, 50 V Chip Capacitors	C1825C473J5RAC	Kemet
C33, C42	22 μ F, 50 V Tantalum Capacitors	T491C226K050AT	Kemet
C40, C41	5.6 pF Chip Capacitors	ATC600F5R6BT250XT	ATC
R1, R2	12 Ω , 1/4 W Chip Resistors	CRCW120612R0FKEA	Vishay
R3, R4	1 K Ω , 1/4 W Chip Resistors	CRCW12061001FKEA	Vishay

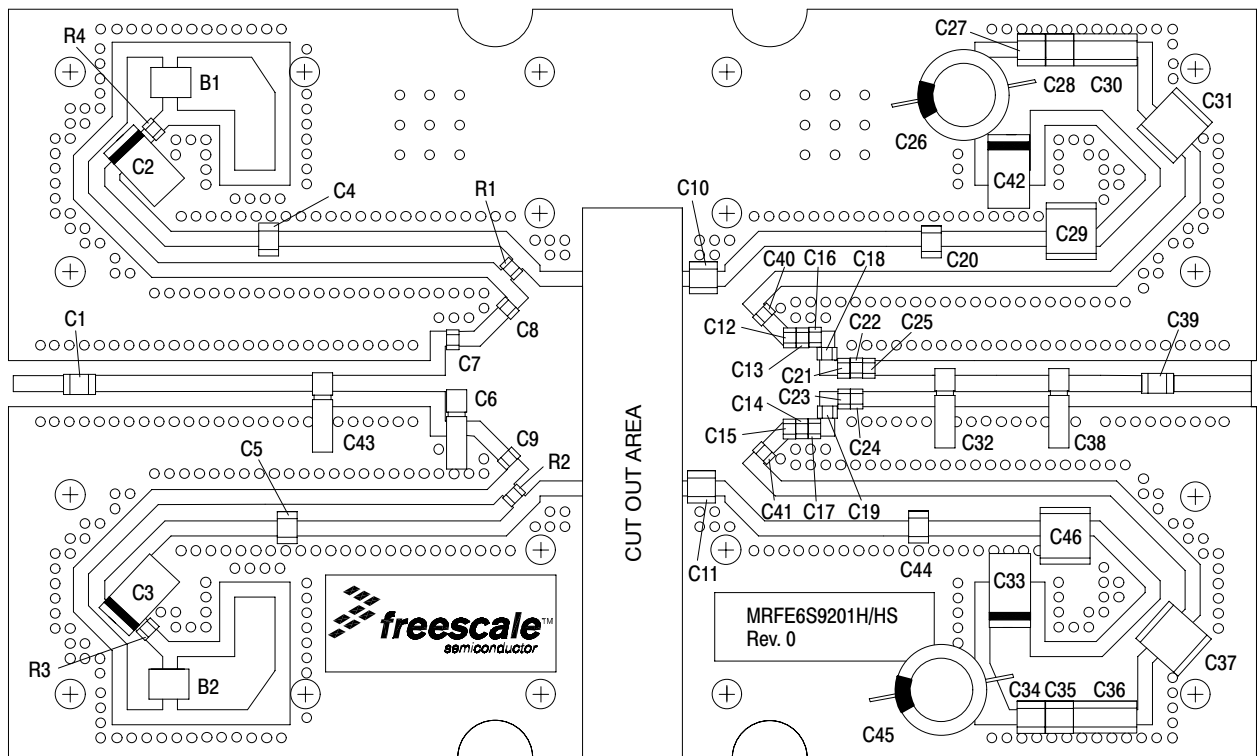

Figure 2. MRFE6S9201HR3(HSR3) Test Circuit Component Layout

TYPICAL CHARACTERISTICS

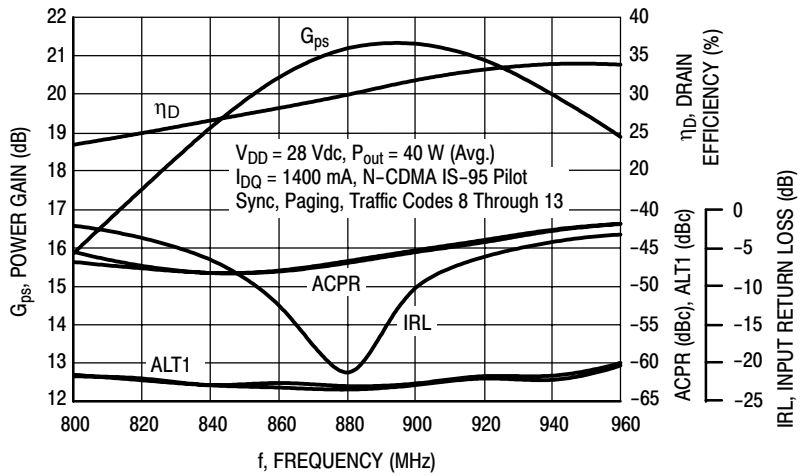

Figure 3. Single-Carrier N-CDMA Broadband Performance @ $P_{out} = 40$ Watts Avg.

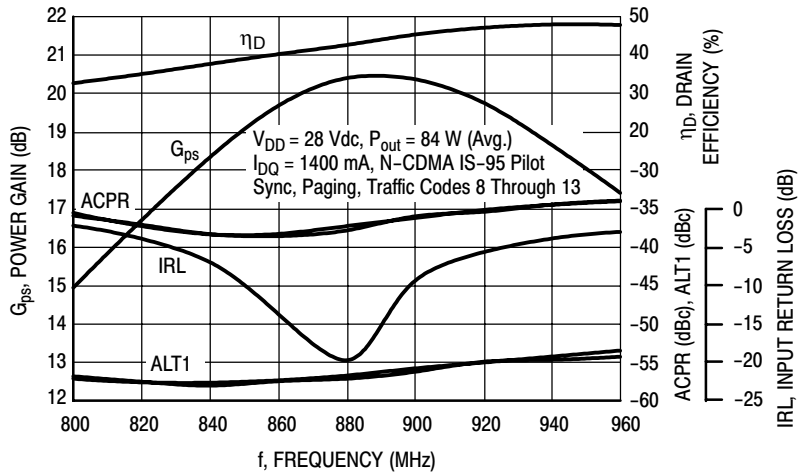

Figure 4. Single-Carrier N-CDMA Broadband Performance @ $P_{out} = 84$ Watts Avg.

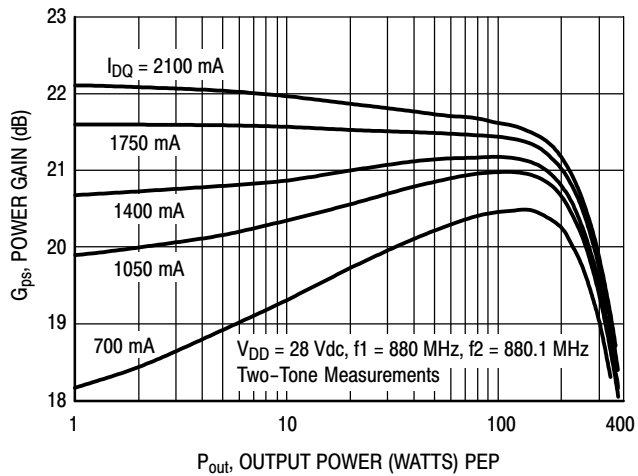

Figure 5. Two-Tone Power Gain versus Output Power

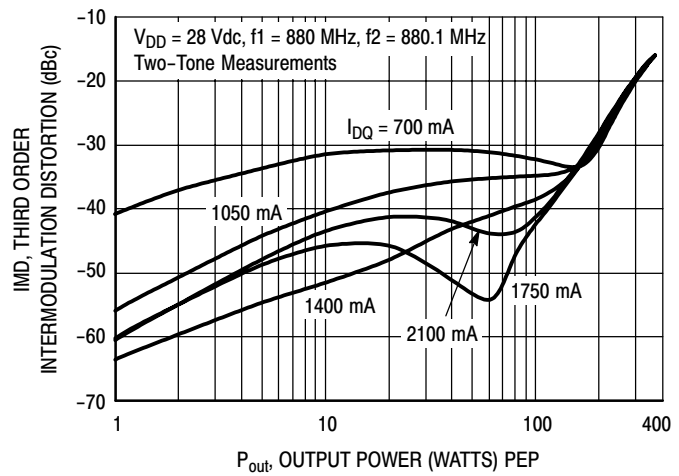

Figure 6. Third Order Intermodulation Distortion versus Output Power

TYPICAL CHARACTERISTICS

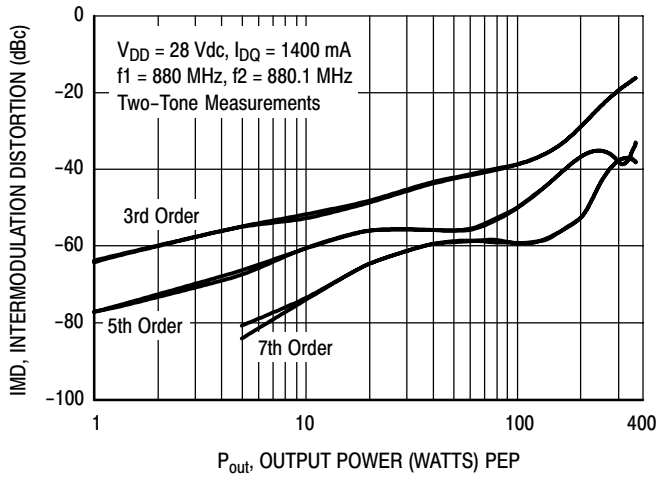

Figure 7. Intermodulation Distortion Products versus Output Power

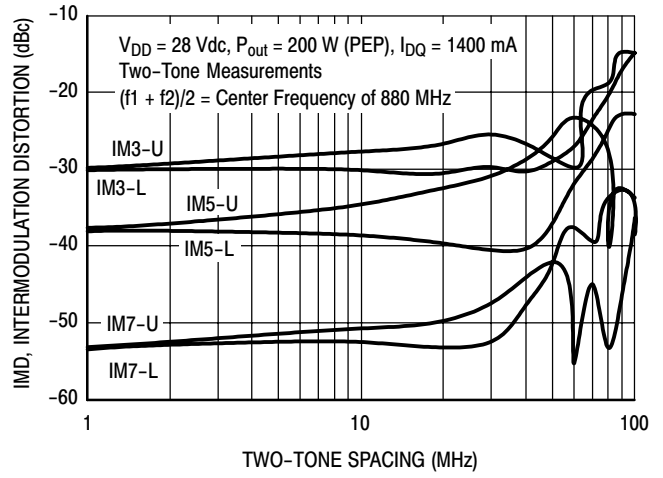

Figure 8. Intermodulation Distortion Products versus Tone Spacing

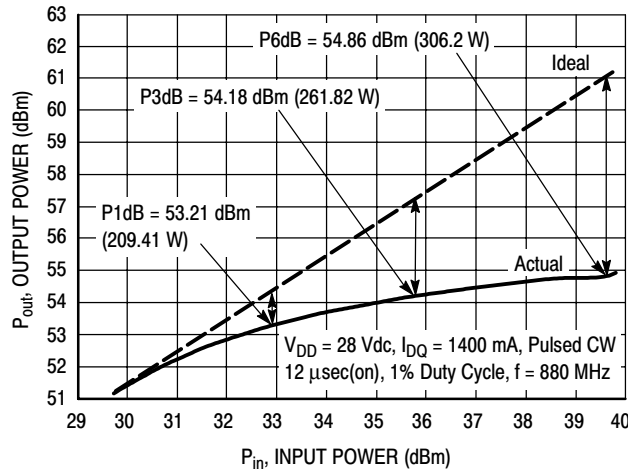

Figure 9. Pulsed CW Output Power versus Input Power

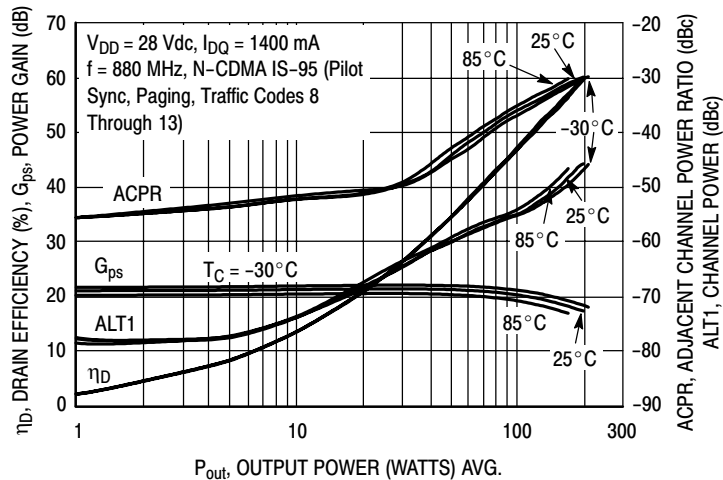

Figure 10. Single-Carrier N-CDMA ACPR, ALT1, Power Gain and Drain Efficiency versus Output Power

TYPICAL CHARACTERISTICS

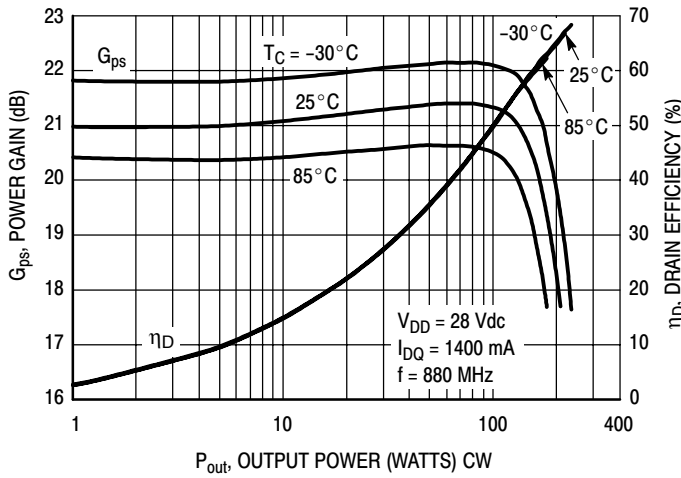

Figure 11. Power Gain and Drain Efficiency versus CW Output Power

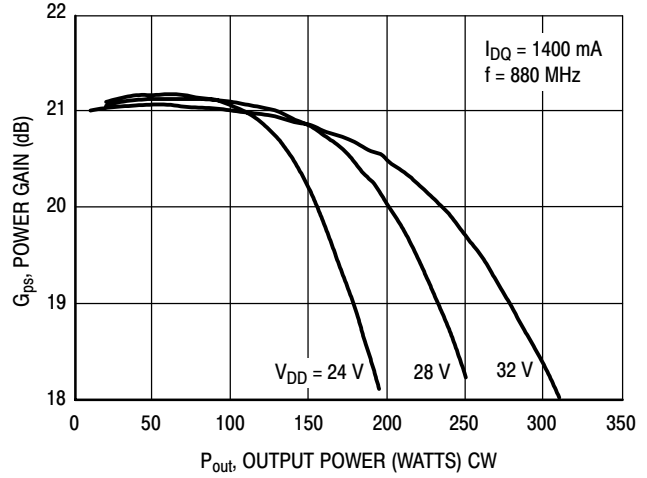
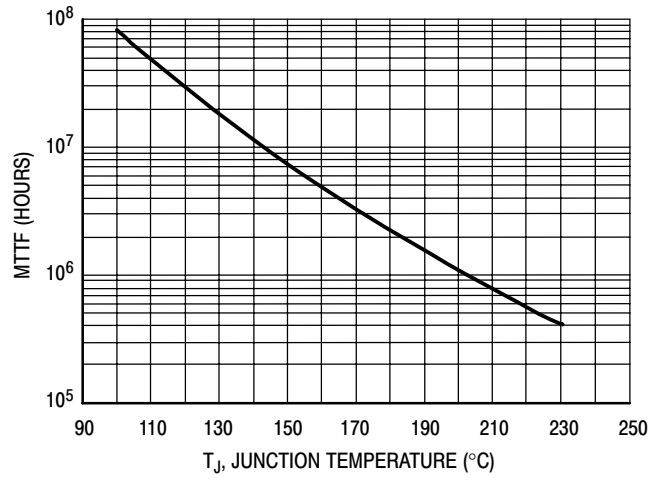

Figure 12. Power Gain versus Output Power



This above graph displays calculated MTTF in hours when the device is operated at $V_{DD} = 28$ Vdc, $P_{out} = 40$ W Avg., and $\eta_D = 31.3\%$.

MTTF calculator available at <http://www.freescale.com/rf>. Select Software & Tools/Development Tools/Calculators to access MTTF calculators by product.

Figure 13. MTTF versus Junction Temperature

N-CDMA TEST SIGNAL

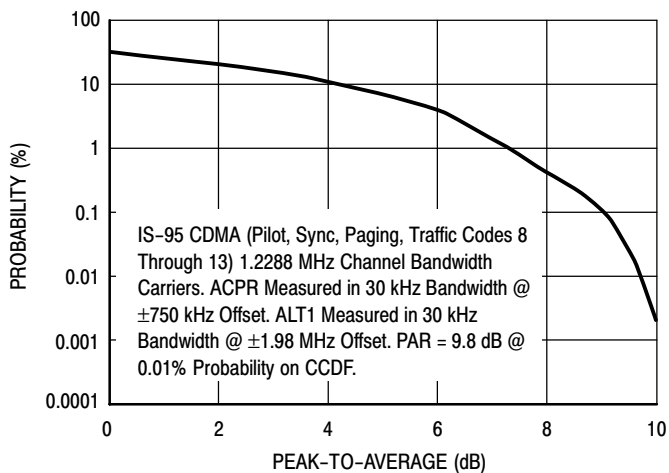

Figure 14. Single-Carrier CCDF N-CDMA

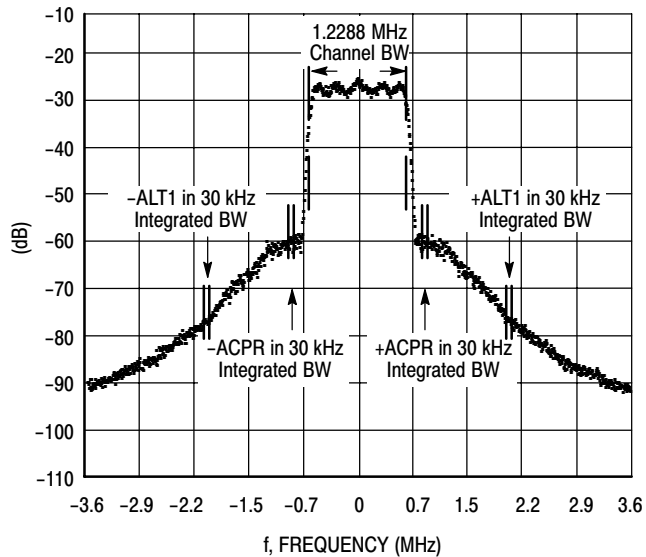
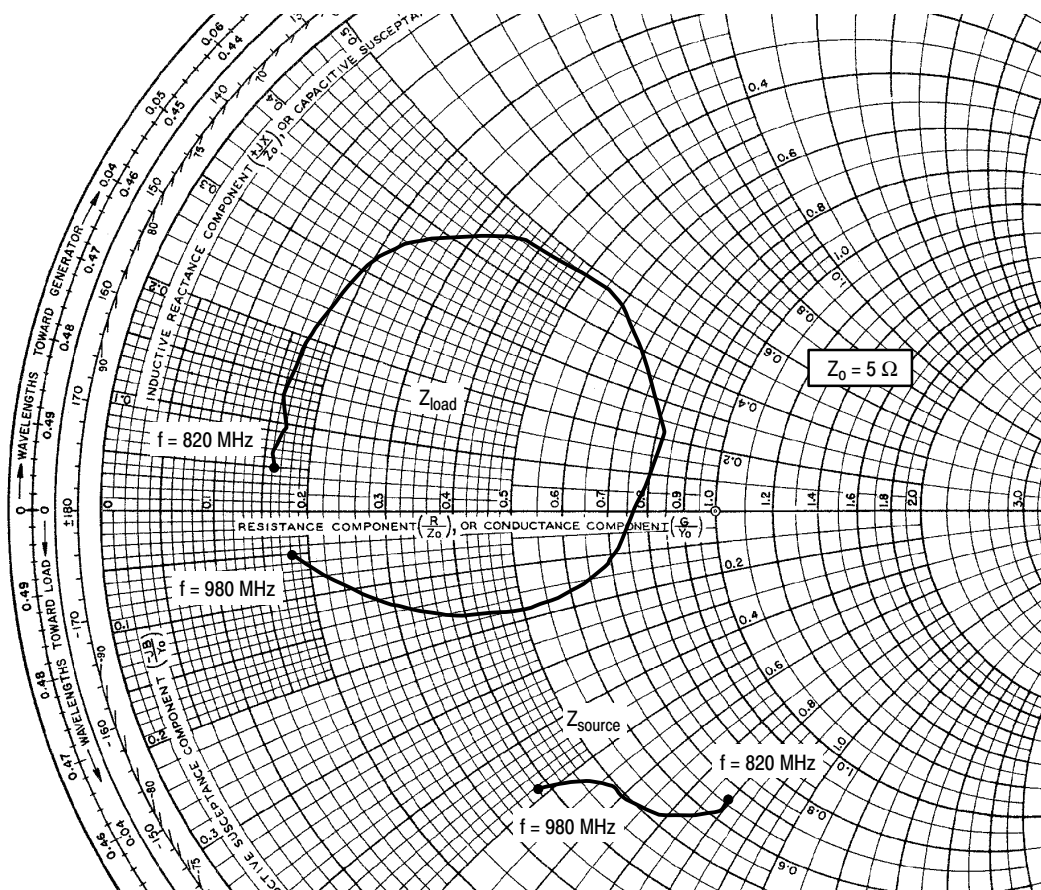

Figure 15. Single-Carrier N-CDMA Spectrum



$V_{DD} = 28 \text{ Vdc}$, $I_{DQ} = 1400 \text{ mA}$, $P_{out} = 40 \text{ W Avg.}$

f MHz	Z_{source} Ω	Z_{load} Ω
820	$3.28 - j3.94$	$0.78 + j0.24$
840	$3.12 - j3.93$	$0.81 + j0.36$
860	$2.85 - j3.73$	$0.83 + j0.51$
880	$2.58 - j3.39$	$0.82 + j0.70$
900	$2.44 - j2.98$	$0.83 + j0.98$
920	$2.43 - j2.87$	$1.02 + j1.60$
940	$2.31 - j2.66$	$4.12 + j1.11$
960	$2.17 - j2.54$	$1.49 - j0.66$
980	$1.91 - j2.39$	$0.90 - j0.26$

Z_{source} = Test circuit impedance as measured from gate to ground.

Z_{load} = Test circuit impedance as measured from drain to ground.

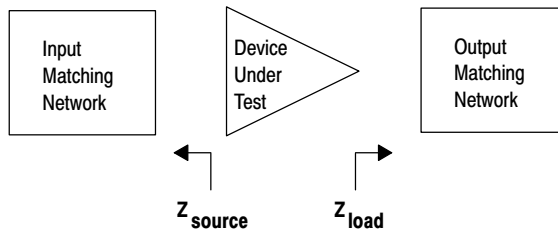
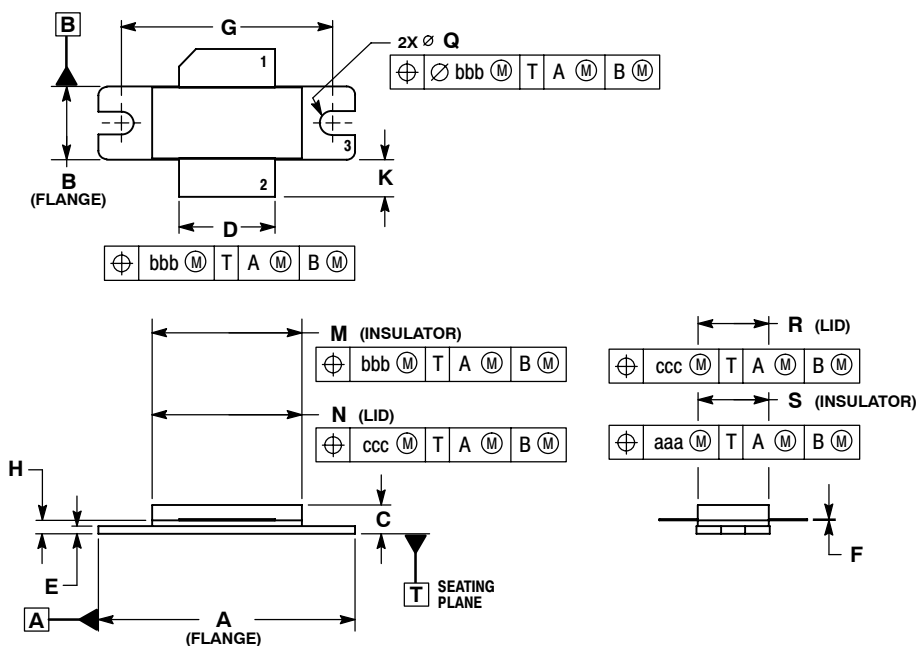

Figure 16. Series Equivalent Source and Load Impedance

PACKAGE DIMENSIONS



- NOTES:
1. DIMENSIONING AND TOLERANCING PER ANSI Y14.5M-1994.
 2. CONTROLLING DIMENSION: INCH.
 3. DELETED
 4. DIMENSION H IS MEASURED 0.030 (0.762) AWAY FROM PACKAGE BODY.

DIM	INCHES		MILLIMETERS	
	MIN	MAX	MIN	MAX
A	1.335	1.345	33.91	34.16
B	0.380	0.390	9.65	9.91
C	0.125	0.170	3.18	4.32
D	0.495	0.505	12.57	12.83
E	0.035	0.045	0.89	1.14
F	0.003	0.006	0.08	0.15
G	1.100 BSC		27.94 BSC	
H	0.057	0.067	1.45	1.70
K	0.170	0.210	4.32	5.33
M	0.774	0.786	19.66	19.96
N	0.772	0.788	19.60	20.00
Q	\varnothing 0.118	\varnothing 0.138	\varnothing 3.00	\varnothing 3.51
R	0.365	0.375	9.27	9.53
S	0.365	0.375	9.27	9.52
aaa	0.005 REF		0.127 REF	
bbb	0.010 REF		0.254 REF	
ccc	0.015 REF		0.381 REF	

- STYLE 1:
1. DRAIN
 2. GATE
 3. SOURCE

**CASE 465-06
ISSUE G
NI-780
MRFE6S9201HR3**

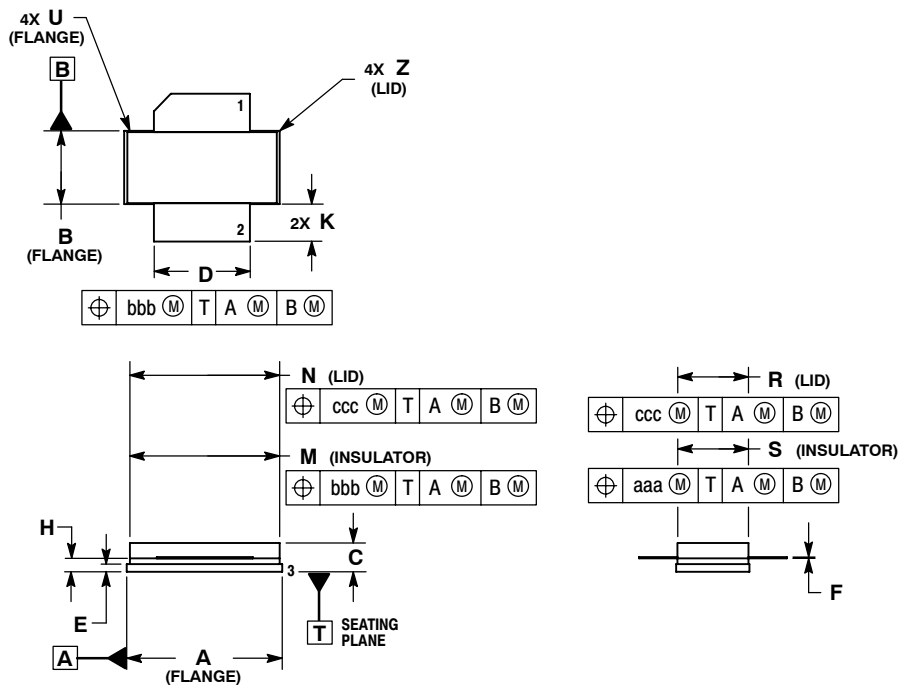

- NOTES:
1. DIMENSIONING AND TOLERANCING PER ANSI Y14.5M-1994.
 2. CONTROLLING DIMENSION: INCH.
 3. DELETED
 4. DIMENSION H IS MEASURED 0.030 (0.762) AWAY FROM PACKAGE BODY.

DIM	INCHES		MILLIMETERS	
	MIN	MAX	MIN	MAX
A	0.805	0.815	20.45	20.70
B	0.380	0.390	9.65	9.91
C	0.125	0.170	3.18	4.32
D	0.495	0.505	12.57	12.83
E	0.035	0.045	0.89	1.14
F	0.003	0.006	0.08	0.15
H	0.057	0.067	1.45	1.70
K	0.170	0.210	4.32	5.33
M	0.774	0.786	19.61	20.02
N	0.772	0.788	19.61	20.02
R	0.365	0.375	9.27	9.53
S	0.365	0.375	9.27	9.52
U	---	0.040	---	1.02
Z	---	0.030	---	0.76
aaa	0.005 REF		0.127 REF	
bbb	0.010 REF		0.254 REF	
ccc	0.015 REF		0.381 REF	

- STYLE 1:
1. DRAIN
 2. GATE
 5. SOURCE

**CASE 465A-06
ISSUE H
NI-780S
MRFE6S9201HSR3**

PRODUCT DOCUMENTATION

Refer to the following documents to aid your design process.

Application Notes

- AN1955: Thermal Measurement Methodology of RF Power Amplifiers

Engineering Bulletins

- EB212: Using Data Sheet Impedances for RF LDMOS Devices

REVISION HISTORY

The following table summarizes revisions to this document.

Revision	Date	Description
0	Sept. 2007	<ul style="list-style-type: none"> • Initial Release of Data Sheet
1	Dec. 2008	<ul style="list-style-type: none"> • Updated Typical Performance Full Frequency Band to $f = 880$ MHz to match production test, p. 1 • Updated Part Numbers in Table 5, Component Designations and Values, to latest RoHS compliant part numbers, p. 5

How to Reach Us:

Home Page:

www.freescale.com

Web Support:

<http://www.freescale.com/support>

USA/Europe or Locations Not Listed:

Freescale Semiconductor, Inc.
Technical Information Center, EL516
2100 East Elliot Road
Tempe, Arizona 85284
1-800-521-6274 or +1-480-768-2130
www.freescale.com/support

Europe, Middle East, and Africa:

Freescale Halbleiter Deutschland GmbH
Technical Information Center
Schatzbogen 7
81829 Muenchen, Germany
+44 1296 380 456 (English)
+46 8 52200080 (English)
+49 89 92103 559 (German)
+33 1 69 35 48 48 (French)
www.freescale.com/support

Japan:

Freescale Semiconductor Japan Ltd.
Headquarters
ARCO Tower 15F
1-8-1, Shimo-Meguro, Meguro-ku,
Tokyo 153-0064
Japan
0120 191014 or +81 3 5437 9125
support.japan@freescale.com

Asia/Pacific:

Freescale Semiconductor China Ltd.
Exchange Building 23F
No. 118 Jianguo Road
Chaoyang District
Beijing 100022
China
+86 10 5879 8000
support.asia@freescale.com

For Literature Requests Only:

Freescale Semiconductor Literature Distribution Center
P.O. Box 5405
Denver, Colorado 80217
1-800-441-2447 or +1-303-675-2140
Fax: +1-303-675-2150
LDCForFreescaleSemiconductor@hibbertgroup.com

Information in this document is provided solely to enable system and software implementers to use Freescale Semiconductor products. There are no express or implied copyright licenses granted hereunder to design or fabricate any integrated circuits or integrated circuits based on the information in this document.

Freescale Semiconductor reserves the right to make changes without further notice to any products herein. Freescale Semiconductor makes no warranty, representation or guarantee regarding the suitability of its products for any particular purpose, nor does Freescale Semiconductor assume any liability arising out of the application or use of any product or circuit, and specifically disclaims any and all liability, including without limitation consequential or incidental damages. "Typical" parameters that may be provided in Freescale Semiconductor data sheets and/or specifications can and do vary in different applications and actual performance may vary over time. All operating parameters, including "Typicals" Microstrip, must be validated for each customer application by customer's technical experts. Freescale Semiconductor does not convey any license under its patent rights nor the rights of others. Freescale Semiconductor products are not designed, intended, or authorized for use as components in systems intended for surgical implant into the body, or other applications intended to support or sustain life, or for any other application in which the failure of the Freescale Semiconductor product could create a situation where personal injury or death may occur. Should Buyer purchase or use Freescale Semiconductor products for any such unintended or unauthorized application, Buyer shall indemnify and hold Freescale Semiconductor and its officers, employees, subsidiaries, affiliates, and distributors harmless against all claims, costs, damages, and expenses, and reasonable attorney fees arising out of, directly or indirectly, any claim of personal injury or death associated with such unintended or unauthorized use, even if such claim alleges that Freescale Semiconductor was negligent regarding the design or manufacture of the part.

Freescale™ and the Freescale logo are trademarks of Freescale Semiconductor, Inc. All other product or service names are the property of their respective owners.

© Freescale Semiconductor, Inc. 2007-2008. All rights reserved.