

General Description

SRFET™ AO4456 uses advanced trench technology with a monolithically integrated Schottky diode to provide excellent $R_{DS(ON)}$, and low gate charge. This device is suitable for use as a low side FET in SMPS, load switching and general purpose applications.

Product Summary

V_{DS}	30V
I_D (at $V_{GS}=10V$)	20A
$R_{DS(ON)}$ (at $V_{GS}=10V$)	< 4.6m Ω
$R_{DS(ON)}$ (at $V_{GS} = 4.5V$)	< 5.6m Ω

100% UIS Tested
 100% R_g Tested

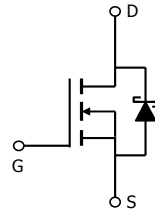
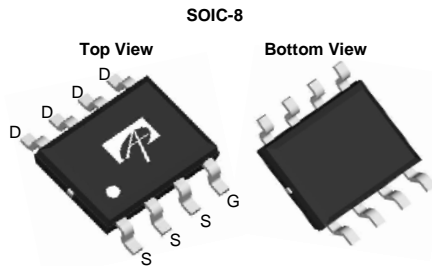

SRFET™
 Soft Recovery MOSFET:
 Integrated Schottky Diode

Absolute Maximum Ratings $T_A=25^\circ\text{C}$ unless otherwise noted

Parameter	Symbol	Maximum	Units
Drain-Source Voltage	V_{DS}	30	V
Gate-Source Voltage	V_{GS}	± 12	V
Continuous Drain Current ^G	I_D	$T_C=25^\circ\text{C}$	20
		$T_C=70^\circ\text{C}$	16
Pulsed Drain Current ^C	I_{DM}	120	A
Avalanche Current ^C	I_{AS}, I_{AR}	47	A
Avalanche energy $L=0.1\text{mH}$ ^C	E_{AS}, E_{AR}	110	mJ
Power Dissipation ^B	P_D	$T_C=25^\circ\text{C}$	3.1
		$T_C=70^\circ\text{C}$	2.0
Junction and Storage Temperature Range	T_J, T_{STG}	-55 to 150	$^\circ\text{C}$

Thermal Characteristics

Parameter	Symbol	Typ	Max	Units
Maximum Junction-to-Ambient ^A	$R_{\theta JA}$	31	40	$^\circ\text{C/W}$
Maximum Junction-to-Ambient ^{A D}		Steady-State	59	75
Maximum Junction-to-Lead	$R_{\theta JL}$	16	24	$^\circ\text{C/W}$

Electrical Characteristics (T_J=25°C unless otherwise noted)

Symbol	Parameter	Conditions	Min	Typ	Max	Units
STATIC PARAMETERS						
BV _{DSS}	Drain-Source Breakdown Voltage	I _D =250μA, V _{GS} =0V	30			V
I _{DSS}	Zero Gate Voltage Drain Current	V _{DS} =30V, V _{GS} =0V T _J =125°C			0.1 20	mA
I _{GSS}	Gate-Body leakage current	V _{DS} =0V, V _{GS} = ±12V			100	nA
V _{GS(th)}	Gate Threshold Voltage	V _{DS} =V _{GS} I _D =250μA	1.2	1.8	2.4	V
I _{D(ON)}	On state drain current	V _{GS} =10V, V _{DS} =5V	120			A
R _{DS(ON)}	Static Drain-Source On-Resistance	V _{GS} =10V, I _D =20A T _J =125°C		3.8 5.9	4.6 7.4	mΩ
		V _{GS} =4.5V, I _D =18A		4.5	5.6	mΩ
g _{FS}	Forward Transconductance	V _{DS} =5V, I _D =20A		112		S
V _{SD}	Diode Forward Voltage	I _S =1A, V _{GS} =0V		0.5	0.7	V
I _S	Maximum Body-Diode Continuous Current				5	A
DYNAMIC PARAMETERS						
C _{iss}	Input Capacitance	V _{GS} =0V, V _{DS} =15V, f=1MHz		4320	5185	pF
C _{oss}	Output Capacitance			570		pF
C _{rss}	Reverse Transfer Capacitance			310	493	pF
R _g	Gate resistance	V _{GS} =0V, V _{DS} =0V, f=1MHz	0.2	0.5	0.9	Ω
SWITCHING PARAMETERS						
Q _{g(10V)}	Total Gate Charge	V _{GS} =10V, V _{DS} =15V, I _D =20A	60	77	95	nC
Q _{g(4.5V)}	Total Gate Charge		30	44	42	nC
Q _{gs}	Gate Source Charge			9.8		nC
Q _{gd}	Gate Drain Charge			16		nC
t _{D(on)}	Turn-On DelayTime	V _{GS} =10V, V _{DS} =15V, R _L =0.75Ω, R _{GEN} =3Ω		11		ns
t _r	Turn-On Rise Time			10		ns
t _{D(off)}	Turn-Off DelayTime			46		ns
t _f	Turn-Off Fall Time			9.5		ns
t _{rr}	Body Diode Reverse Recovery Time	I _F =20A, dI/dt=500A/μs		12	15	ns
Q _{rr}	Body Diode Reverse Recovery Charge	I _F =20A, dI/dt=500A/μs		20		nC

A. The value of R_{qJA} is measured with the device mounted on 1in2 FR-4 board with 2oz. Copper, in a still air environment with T_A =25°C. The value in any given application depends on the user's specific board design.

B. The power dissipation PD is based on T_J(MAX)=150°C, using ≤ 10s junction-to-ambient thermal resistance.

C. Repetitive rating, pulse width limited by junction temperature T_J(MAX)=150°C. Ratings are based on low frequency and duty cycles to keep initial T_J=25°C.

D. The R_{qJA} is the sum of the thermal impedance from junction to lead R_{qJL} and lead to ambient.

E. The static characteristics in Figures 1 to 6 are obtained using <300ms pulses, duty cycle 0.5% max.

F. These curves are based on the junction-to-ambient thermal impedance which is measured with the device mounted on 1in2 FR-4 board with 2oz. Copper, assuming a maximum junction temperature of T_J(MAX)=150°C. The SOA curve provides a single pulse rating.

COMPONENTS IN LIFE SUPPORT DEVICES OR SYSTEMS ARE NOT AUTHORIZED. AOS DOES NOT ASSUME ANY LIABILITY ARISING OUT OF SUCH APPLICATIONS OR USES OF ITS PRODUCTS. AOS RESERVES THE RIGHT TO IMPROVE PRODUCT DESIGN, FUNCTIONS AND RELIABILITY WITHOUT NOTICE.

TYPICAL ELECTRICAL AND THERMAL CHARACTERISTICS

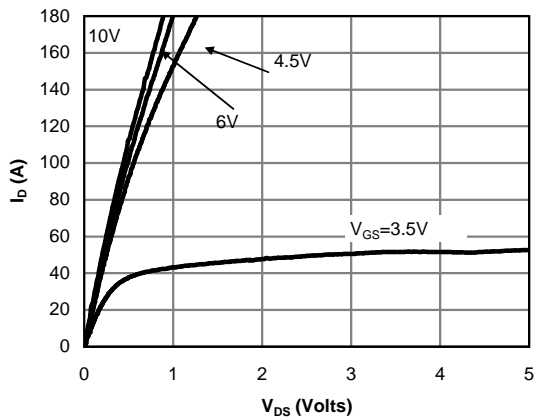

Fig 1: On-Region Characteristics (Note E)

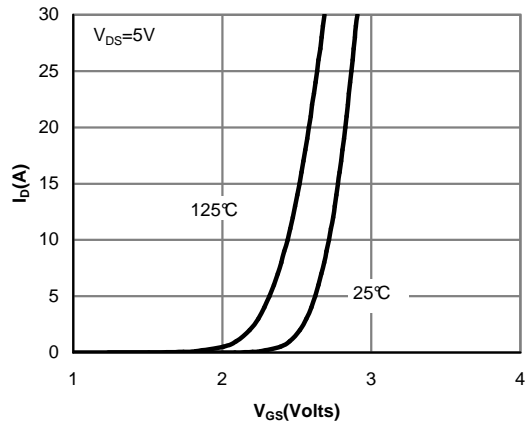

Figure 2: Transfer Characteristics (Note E)

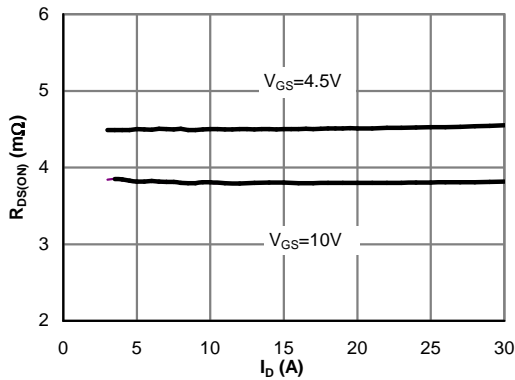

Figure 3: On-Resistance vs. Drain Current and Gate Voltage (Note E)

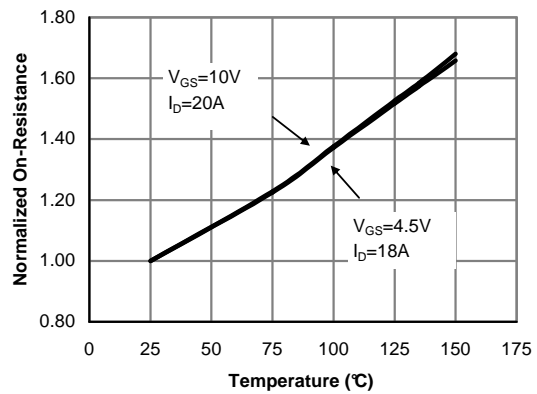

Figure 4: On-Resistance vs. Junction Temperature (Note E)

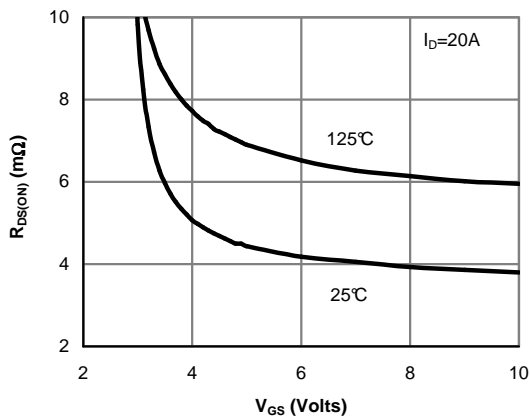

Figure 5: On-Resistance vs. Gate-Source Voltage (Note E)

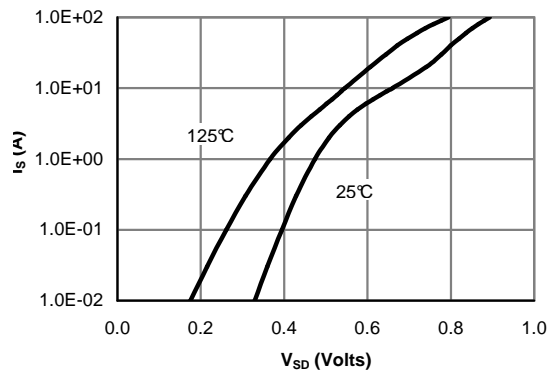

Figure 6: Body-Diode Characteristics (Note E)

TYPICAL ELECTRICAL AND THERMAL CHARACTERISTICS

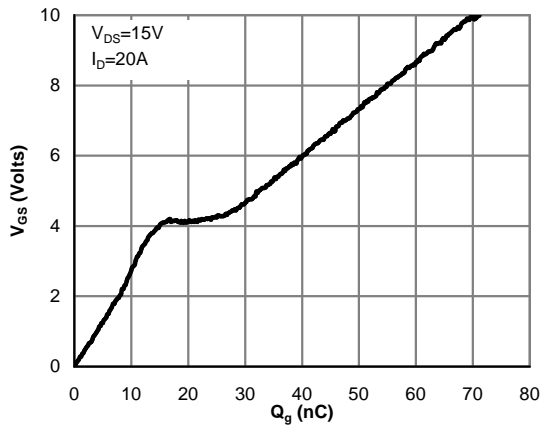

Figure 7: Gate-Charge Characteristics

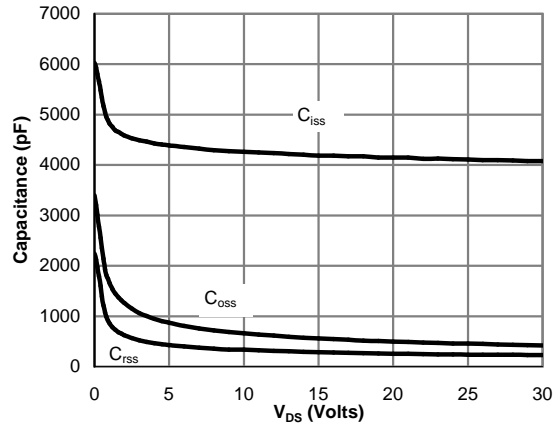

Figure 8: Capacitance Characteristics

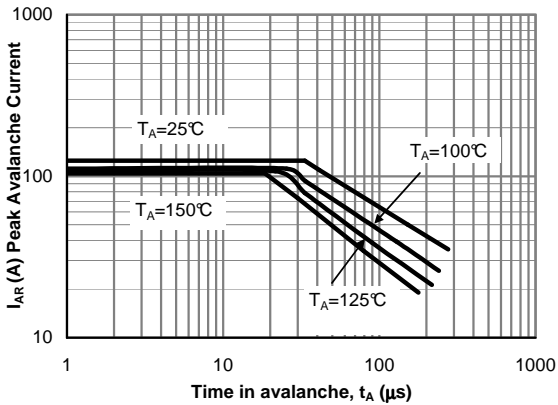

Figure 9: Single Pulse Avalanche capability (Note C)

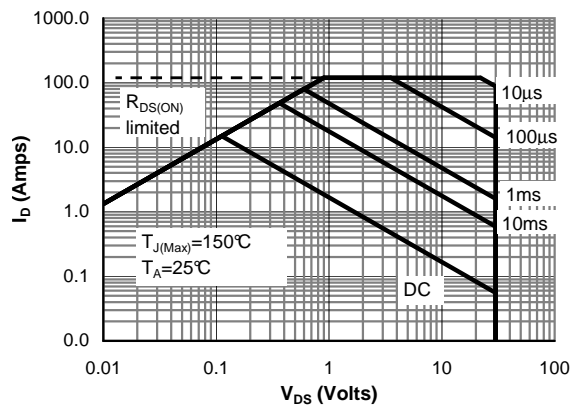

Figure 10: Maximum Forward Biased Safe Operating Area (Note F)

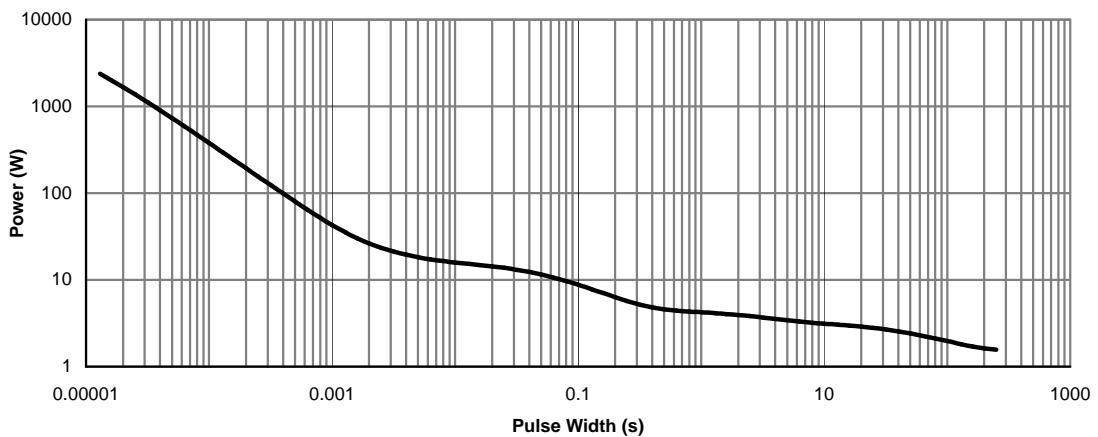

Figure 11: Single Pulse Power Rating Junction-to-Ambient (Note F)

TYPICAL ELECTRICAL AND THERMAL CHARACTERISTICS

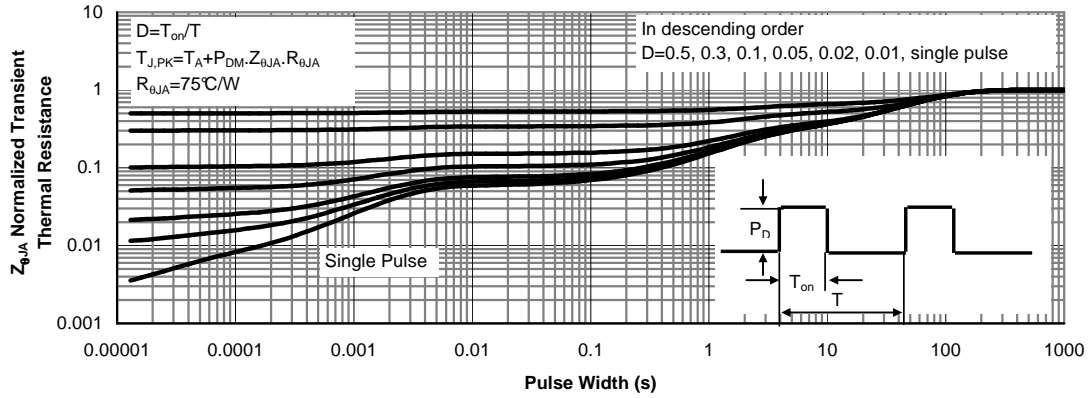

Figure 12: Normalized Maximum Transient Thermal Impedance (Note F)

TYPICAL ELECTRICAL AND THERMAL CHARACTERISTICS

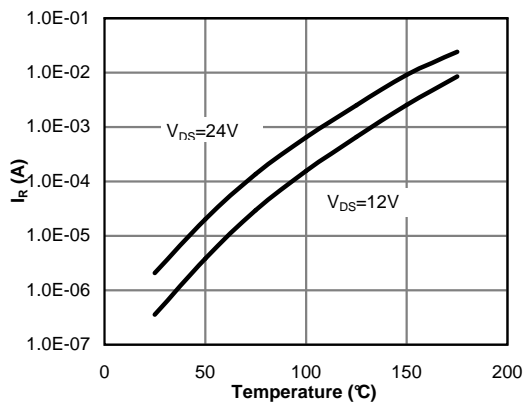

Figure 13: Diode Reverse Leakage Current vs. Junction Temperature

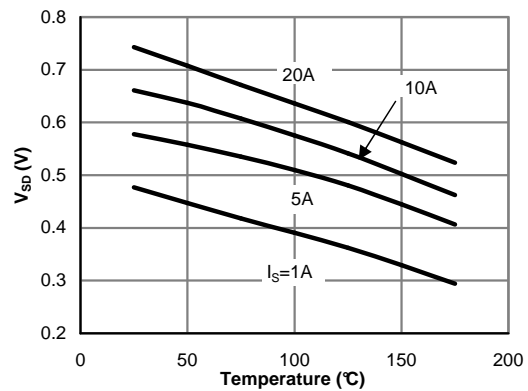

Figure 14: Diode Forward voltage vs. Junction Temperature

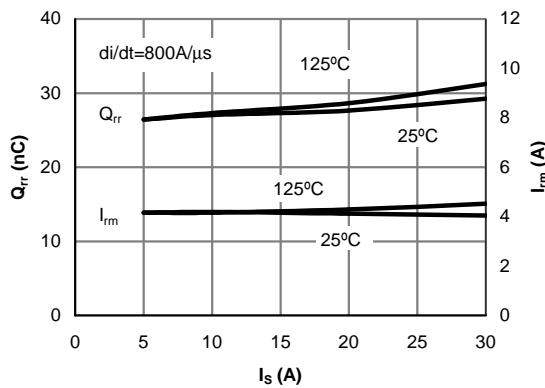

Figure 15: Diode Reverse Recovery Charge and Peak Current vs. Conduction Current

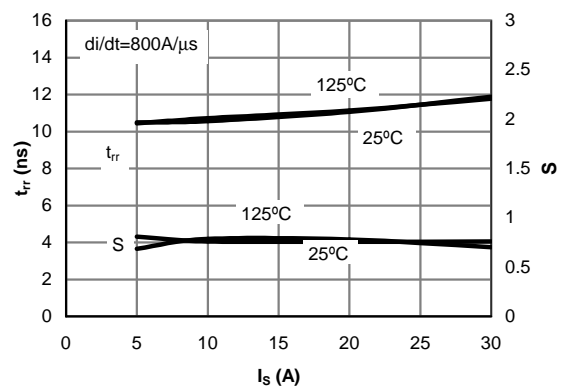

Figure 16: Diode Reverse Recovery Time and Softness Factor vs. Conduction Current

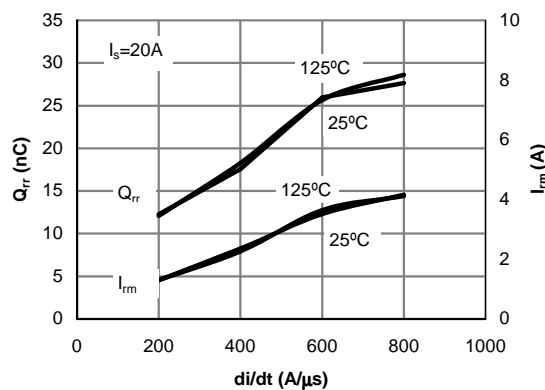

Figure 17: Diode Reverse Recovery Charge and Peak Current vs. di/dt

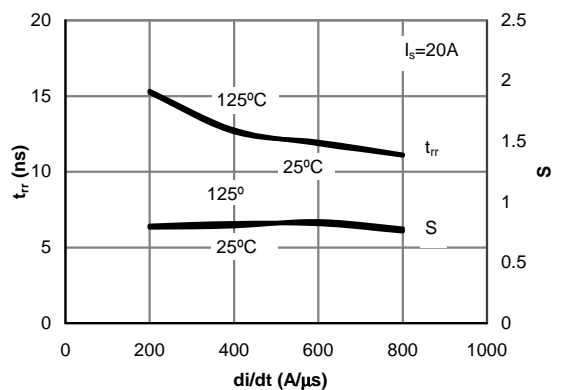
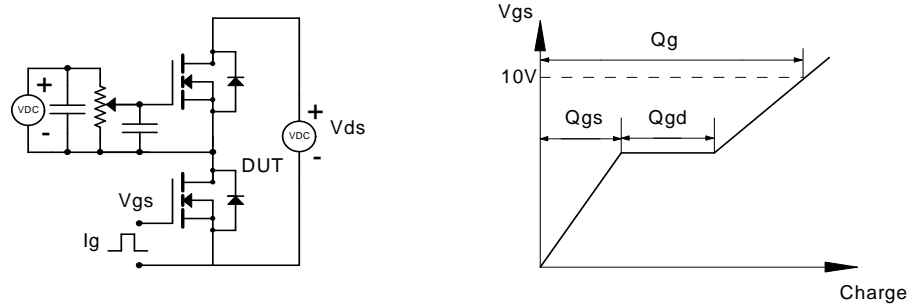
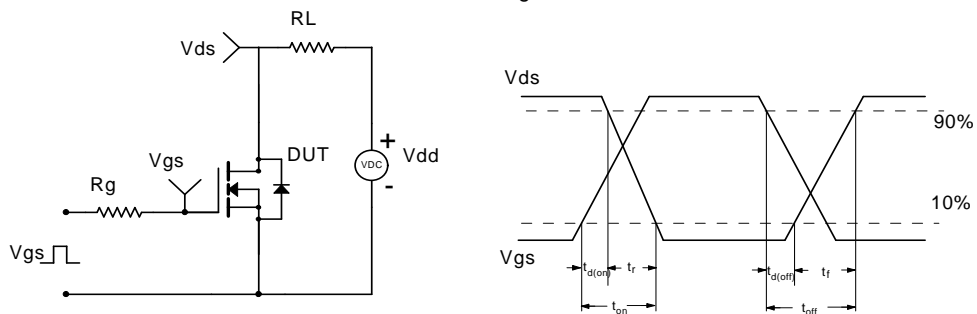

Figure 18: Diode Reverse Recovery Time and Softness Factor vs. di/dt

Gate Charge Test Circuit & Waveform



Resistive Switching Test Circuit & Waveforms



Unclamped Inductive Switching (UIS) Test Circuit & Waveforms

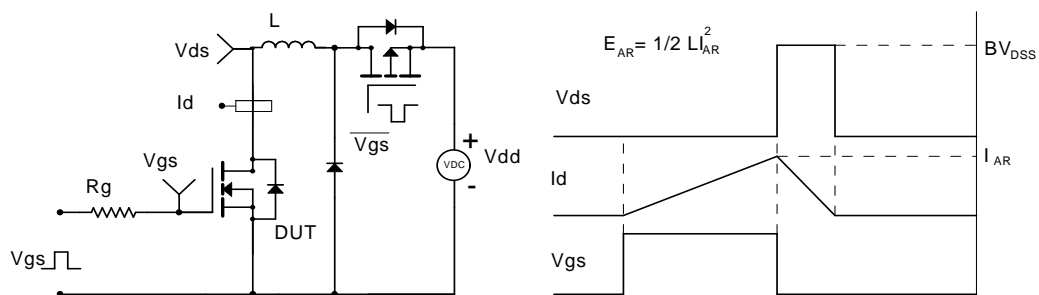

Diode Recovery Test Circuit & Waveforms

