

FLORENTINA-1-RS

~10° real spot beam

SPECIFICATION:

Dimensions	39.7 x 39.7 mm
Height	17.6 mm
Fastening	tape
ROHS compliant	yes ⓘ

MATERIALS:

Component	Type	Material	Colour	Finish
ROSE-B-B-RS	Single lens	PC	clear	
FLORENTINA-1-HLD	Holder	PC	black	
ROSE-TAPE	Tape	Acrylic foam	black	

ORDERING INFORMATION:

Component	Type	Qty in box	MOQ	MPQ	Box weight (kg)
FCA15449_FLORENTINA-1-RS » Box size: 480 x 280 x 300 mm	Single lens	840		60	7.9



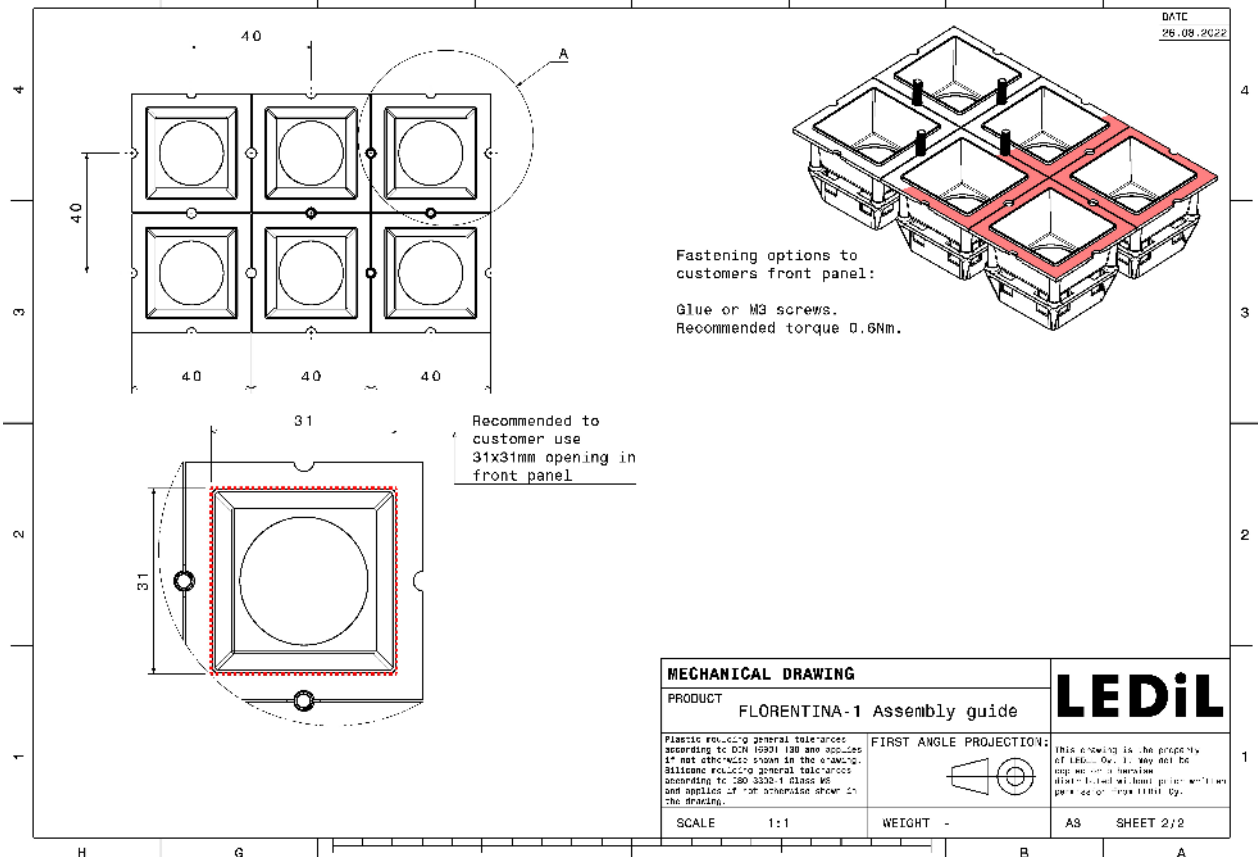
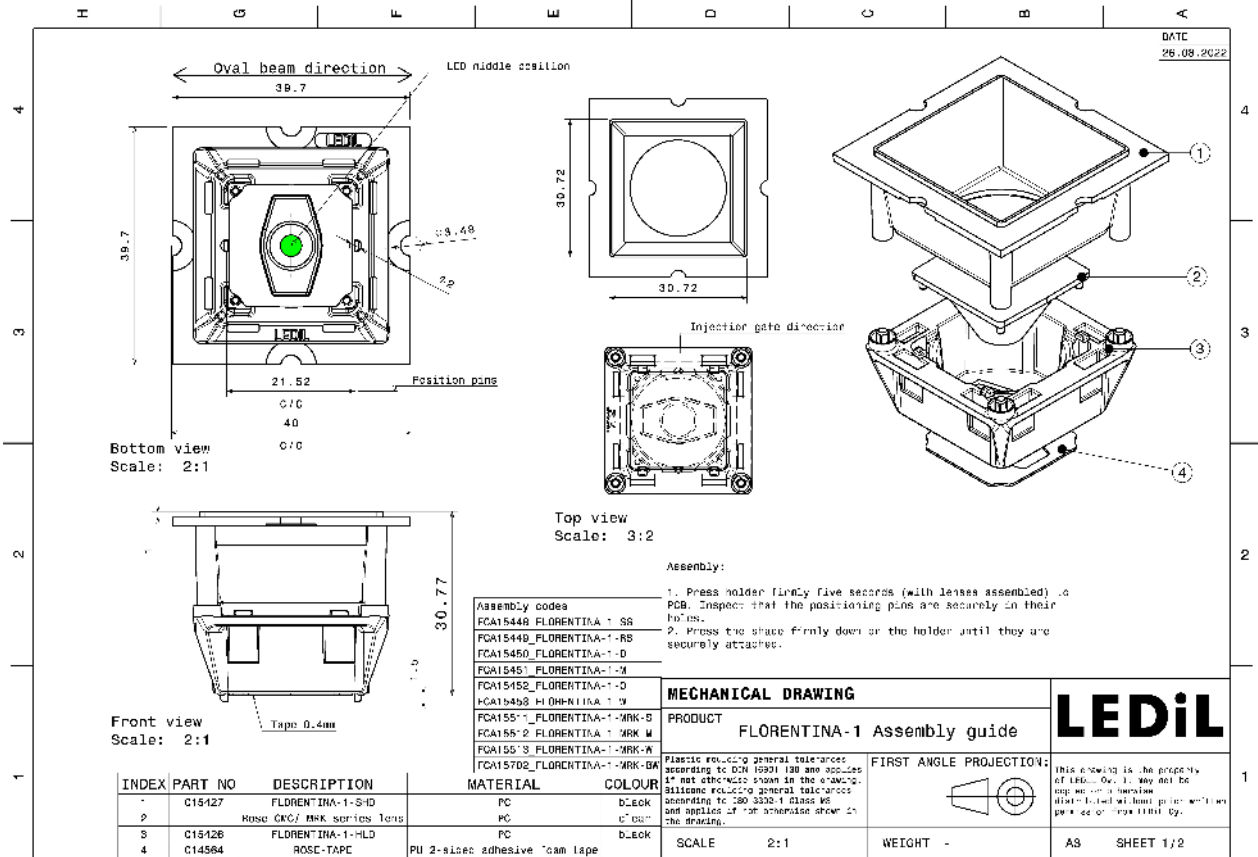

See also our general installation guide: www.ledil.com/installation_guide

OPTICAL RESULTS (MEASURED):

CREE LED

LED XHP35 HI
 FWHM / FWTM 12.0° / 23.0°
 Efficiency 81 %
 Peak intensity 13.7 cd/lm
 LEDs/each optic 1
 Light colour White
 Required components:
 C15427_FLORENTINA-1-SHD-60

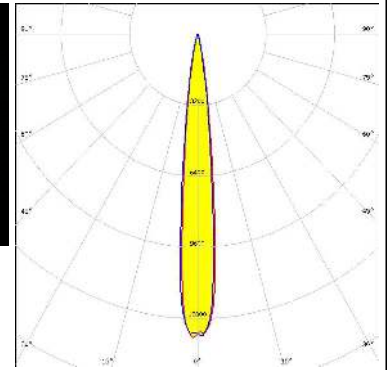

CREE LED

LED XP-L HD
 FWHM / FWTM 16.0° / 27.0°
 Efficiency 80 %
 Peak intensity 9.3 cd/lm
 LEDs/each optic 1
 Light colour White
 Required components:
 C15427_FLORENTINA-1-SHD-60

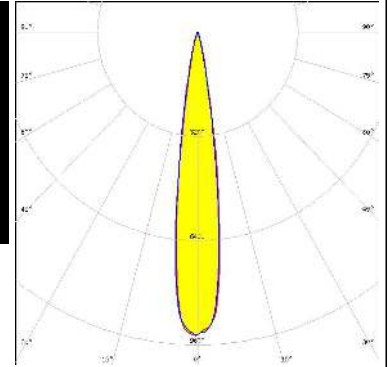

CREE LED

LED XP-L2
 FWHM / FWTM 16.0° / 32.0°
 Efficiency 79 %
 Peak intensity 7.3 cd/lm
 LEDs/each optic 1
 Light colour White
 Required components:
 C15427_FLORENTINA-1-SHD-60

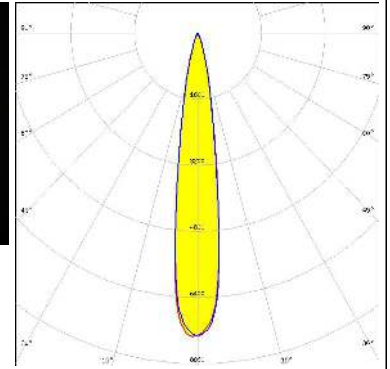

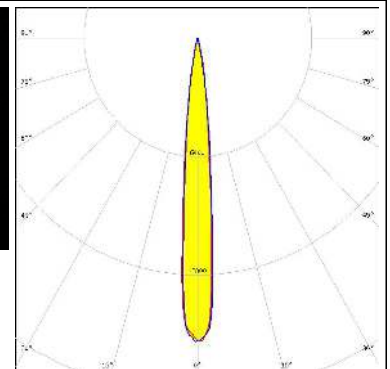

LUMILEDS

LED LUXEON TX
 FWHM / FWTM 11.0° / 22.0°
 Efficiency 83 %
 Peak intensity 16.4 cd/lm
 LEDs/each optic 1
 Light colour White
 Required components:
 C15427_FLORENTINA-1-SHD-60

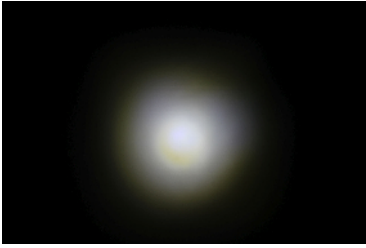
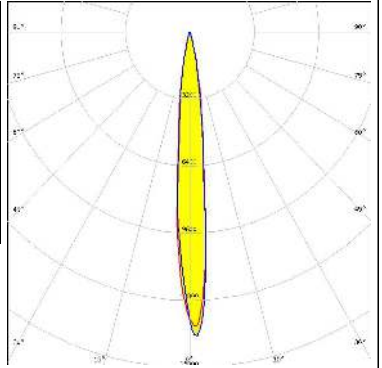
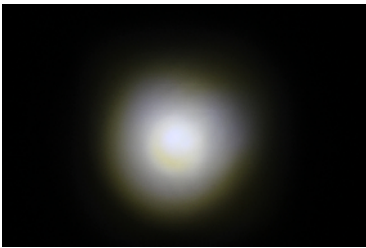
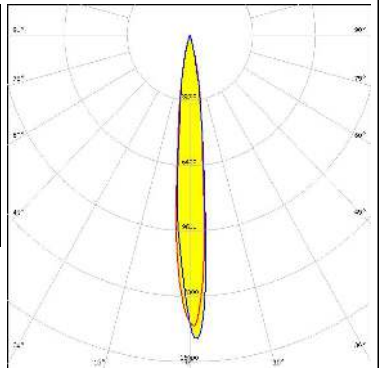
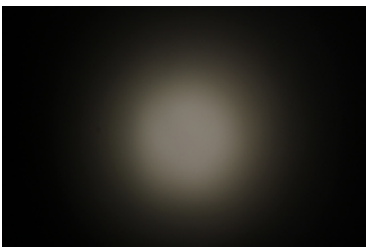
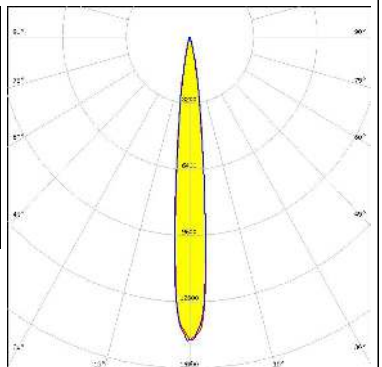

OPTICAL RESULTS (MEASURED):

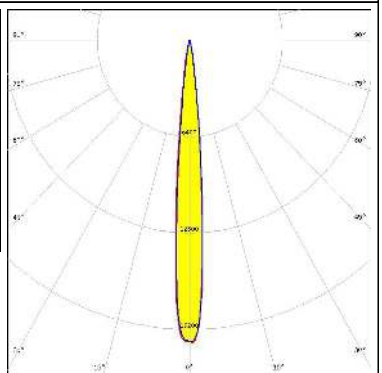
<p>NICHIA</p> <p>LED NF2x757G FWHM / FWTM 11.0° / 25.0° Efficiency 83 % Peak intensity 14.9 cd/lm LEDs/each optic 1 Light colour White Required components: C16701_FLORENTINA-1-SHD-60-WHT</p>		
<p>NICHIA</p> <p>LED NF2x757G FWHM / FWTM 27.0° / 44.0° Efficiency 73 % Peak intensity 3.5 cd/lm LEDs/each optic 1 Light colour White Required components: C15427_FLORENTINA-1-SHD-60</p>		
<p>NICHIA</p> <p>LED NVSxx19B/NVSxx19C FWHM / FWTM 11.0° / 23.0° Efficiency 81 % Peak intensity 14.7 cd/lm LEDs/each optic 1 Light colour White Required components: C15427_FLORENTINA-1-SHD-60</p>		
<p>OSRAM <small>Opto Semiconductors</small></p> <p>LED OSLON Square EC FWHM / FWTM 10.0° / 19.0° Efficiency 81 % Peak intensity 20.1 cd/lm LEDs/each optic 1 Light colour White Required components: C15427_FLORENTINA-1-SHD-60</p>		

OPTICAL RESULTS (MEASURED):

SAMSUNG

LED LM561B
 FWHM / FWTM 8.0° / 20.0°
 Efficiency 84 %
 Peak intensity 21.1 cd/lm
 LEDs/each optic 1
 Light colour White
 Required components:
 C15427_FLORENTINA-1-SHD-60

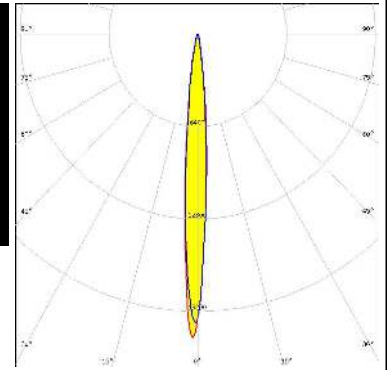

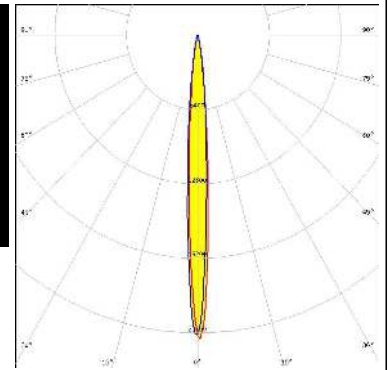
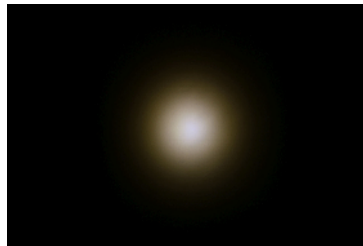

LED SEOUL 5630
 FWHM / FWTM 8.0° / 18.0°
 Efficiency 87 %
 Peak intensity 26.2 cd/lm
 LEDs/each optic 1
 Light colour White
 Required components:

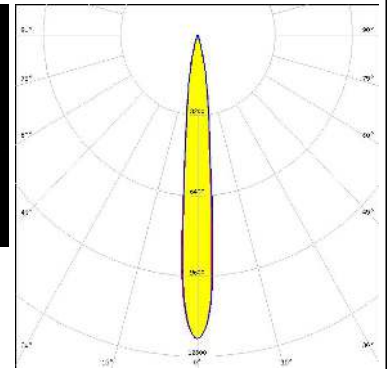

LED Z8Y22P
 FWHM / FWTM 11.0° / 26.0°
 Efficiency 77 %
 Peak intensity 12.1 cd/lm
 LEDs/each optic 1
 Light colour White
 Required components:
 C15427_FLORENTINA-1-SHD-60

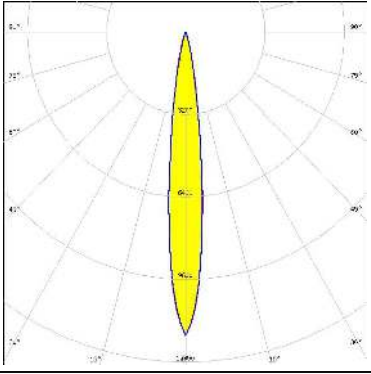

OPTICAL RESULTS (SIMULATED):

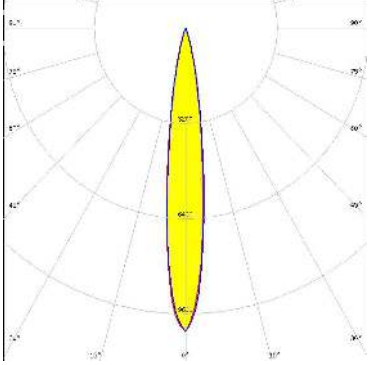
 SEOUL SEMICONDUCTOR		
LED	Z5M3	
FWHM / FWTM	13.0° / 26.0°	
Efficiency	85 %	
Peak intensity	11.8 cd/lm	
LEDs/each optic	1	
Light colour	White	
Required components:		
 SEOUL SEMICONDUCTOR		
LED	Z5M4	
FWHM / FWTM	14.0° / 30.0°	
Efficiency	85 %	
Peak intensity	10.2 cd/lm	
LEDs/each optic	1	
Light colour	White	
Required components:		

GENERAL INFORMATION:

NOTE: The typical beam angle will be changed by different color, chip size and chip position tolerance. The typical total beam angle is the full angle measured where the luminous intensity is half of the peak value.

MATERIALS:

As part of our continuous research and improvement processes, and to ensure the best possible quality and availability of our products, LEDiL reserves the right to change material grades without notice.

PRODUCT DATA USER AGREEMENT AND DISCLAIMER:

The measured data in the provided downloadable LEDiL Product Datasheets and Mechanical 2D-Drawings is rounded and provided as reference for planning. LEDiL Oy's optical specifications have been verified by conducting performance testing of the products in accordance with the company's quality system. The reported data are averaged results of multiple measurements with typical variation. LEDiL Oy reserves the right to without prior notification make changes and improvements to its products.

LEDiL Oy assumes neither warranty, nor guarantee nor any other liability of any kind for the contents and correctness of the provided data. The provided data has been generated with highest diligence but the provided data may in reality not represent the complete possible variation range of all intrinsic parameters. Therefore, in certain cases a deviation from the provided data could occur.

LEDiL Oy reserves the right to undertake technical changes of its products without further notification which could lead to changes in the provided data. LEDiL Oy assumes no liability of any kind for the possible deviation from any provided data or any other damage resulting from the usage of the provided data.

The user agrees to this disclaimer and user agreement with the download or usage of the provided files.

LEDiL Oy

Joensuunkatu 13
FI-24240 SALO
Finland

LEDiL Inc.

228 West Page Street
Suite D
Sycamore IL 60178
USA

Ledil Optics Technology (Shenzhen) Co., Ltd.

405 , Block B
Casic Motor Building
Shenzhen 518057
P.R.CHINA

Local sales and technical support

[www.ledil.com/
where_to_buy](http://www.ledil.com/where_to_buy)

Shipping locations

Salo, Finland
Hong Kong, China

Distribution Partners

[www.ledil.com/
where_to_buy](http://www.ledil.com/where_to_buy)