

REVISIONS					
REV	ECO	DESCRIPTION	DATE	BY	APPR
A1	-	RELEASE NEW DRAWING	15JUN18	SULLEN	TOMMY
A2	-	REVISED DRAWING	10JUL20	JHEAD	DH

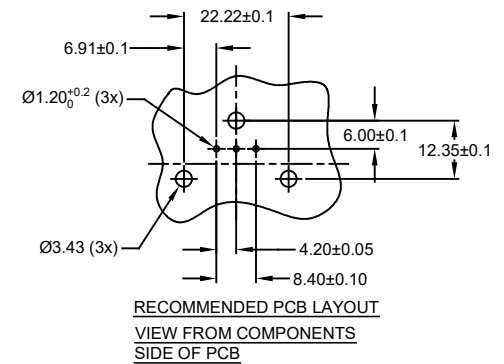
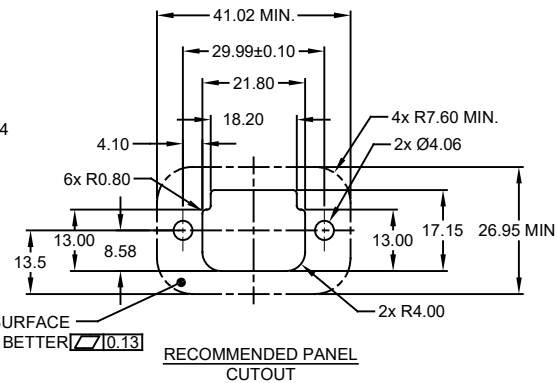
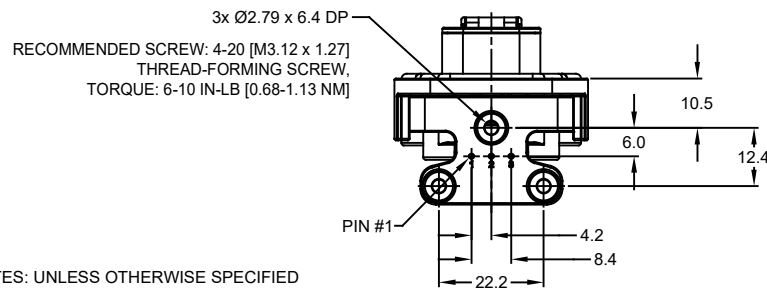
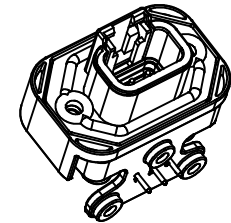
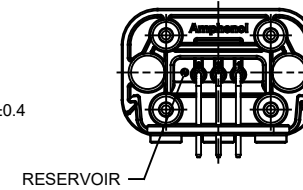
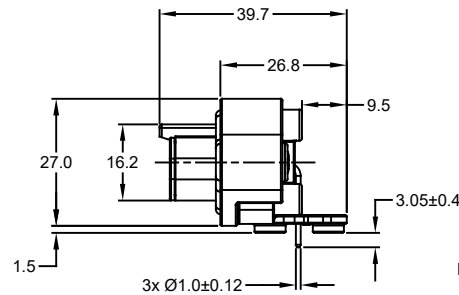
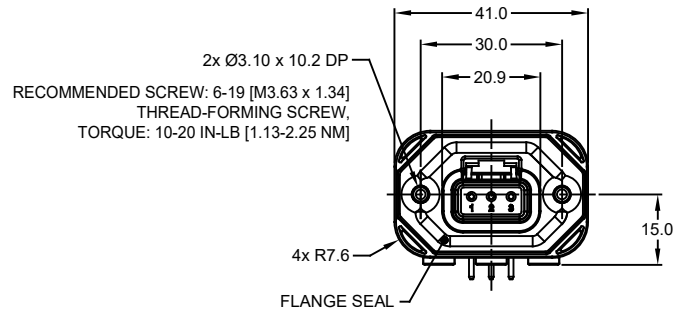

NOTES: UNLESS OTHERWISE SPECIFIED

- MATERIAL:  
HOUSING: THERMOPLASTIC, GREY  
SEAL: SILICONE RUBBER  
CONTACT: COPPER ALLOY
- MODIFICATIONS: FLANGE; RA PCB MOUNT
- SPECIFICATIONS:  
3.1 CURRENT RATING: 7.5 AMPS  
3.2 OPERATING TEMPERATURE: -55°C TO +125°C  
3.3 DIELECTRIC WITHSTANDING VOLTAGE: LESS THAN 2 MILLIAMPS CURRENT LEAKAGE @ 1500 VOLTS AC.  
3.4 INSULATION RESISTANCE: 1000 MEGOHMS MIN @ 25°C  
3.5 MOISTURE RESISTANCE: IP67 (MATED CONDITION)  
3.6 MATING CYCLE DURABILITY: 100 CYCLES  
3.7 RoHS COMPLIANT
- MATING PART: ATM06-3S\* (\* = ALL MODIFICATIONS)
- ALL DIMENSIONS ARE FOR REFERENCE USE ONLY
- POTTED CONNECTORS SPECIFIED FOR UP TO 5 P.S.I. APPLICATIONS.

ATM13-3P-BMXX VARIANTS		
CONTACT PLATING	POTTING OR NOT IN RESERVOIR	PART NUMBER
GOLD	NO POTTING	ATM13-3P-BM01
GOLD	POTTING	ATM13-3P-BM02
TIN	NO POTTING	ATM13-3P-BM03
TIN	POTTING	ATM13-3P-BM04

ATM13-3P-BMXX		PART NUMBER		DESCRIPTION		ITEM
<p>QUANTITY</p> <p>UNLESS OTHERWISE SPECIFIED</p> <p>1) All dimensions are in metric (mm).</p> <p>2) Tolerances are as follows: 1 PL DEC ±0.30   Fractions ±1/64 2 PL DEC ±0.15   Angles ±1° 3 PL DEC ±0.08</p> <p>3) Note reference = </p> <p>SIGNATURES</p> <p>DATE</p> <p>DRAWN: SULLEN ZHANG 15JUN18</p> <p>CHECKED: ORION LI 15JUN18</p> <p>ENGINEER: TOMMY XIE 15JUN18</p> <p>APPROVAL: TOMMY XIE 15JUN18</p> <p>MATERIAL SPECIFICATIONS:</p> <p>CUSTOMER:</p> <p>PROCESS SPECIFICATIONS:</p> <p>THIS DRAWING IS SUPPLIED FOR INFORMATION ONLY. DESIGN FEATURES, SPECIFICATIONS AND PERFORMANCE DATA SHOWN HEREON ARE THE PROPERTY OF THE AMPHENOL CORPORATION. NO RIGHTS OF REPRODUCTION ARE IMPLIED. ALL DIMENSIONS ARE SUBJECT TO NORMAL MANUFACTURING VARIATIONS.</p> <p>SCALE: NONE</p> <p>SIZE: B C- TYPE: NONE</p> <p>DWG NO: ATM13-3P-BMXX</p> <p>REVISION: A2</p> <p>SHEET 1 OF 1</p>						
<p><b>Amphenol</b></p> <p>Sine Systems - www.amphenol-sine.com 44724 Morley Drive Clinton Township, MI 48036</p> <p>BOARDLOCK PCB MOUNT RECEPTACLE, 3 PIN, RA FLANGE, ATM SERIES</p>						

TITLE: POSITION RECEPTACLE, 3PIN, RA FLANGE, ATM SERIES  
DWG NO: ATM13-3P-BMXX  
REV: A2  
SHEET: 1 OF 1