

Material :

- \* Body : Nylon 6T With 30% GF. UL 94V-0, Color Nature
- \* Slider : Nylon 6T With 30% GF. UL 94V-0, Color Black
- \* Contact : Phosphor Bronze
- \* Fixed tab : Brass with Tin Plated

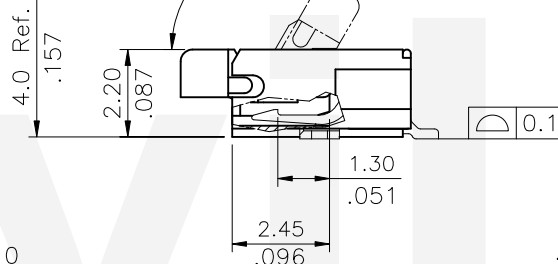

DIM.A = 0.50 x No. of Spaces  
 DIM.B = DIM.A + 4.6  
 DIM.C = DIM.A + 1.1  
 \* Available in 5 through 65 circuits

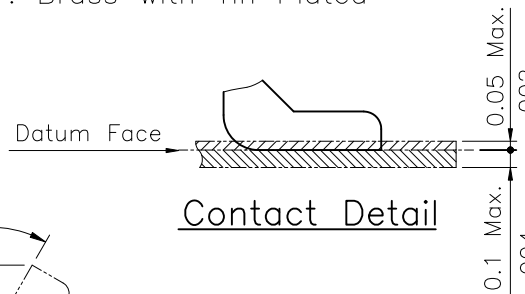
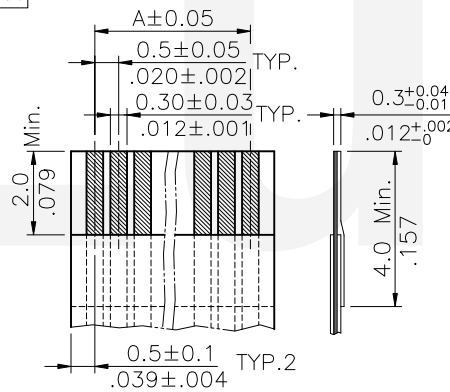

Accommodated FFC/FPC

Ordering Code

CF25 \*\* 1 D 0 \*0 - 05 - NH  
 ① ② ③ ④ ⑤ ⑥ ⑦ ⑧

- ① Series No.
- ② No. of Circuits
- ③ Plating code:  
1= Matte Tin plated over Nickel  
2= Gold flash over 50u"min. Nickel
- ④ Contact style: D= Downside contact
- ⑤ Color: 0= Nature
- ⑥ Other option: R0= Tape & Reel  
T0= Tube Packing
- ⑦ Pitch: 05= 0.50 mm
- ⑧ -NH= For Lead Free IR Processes and Halogen-Free

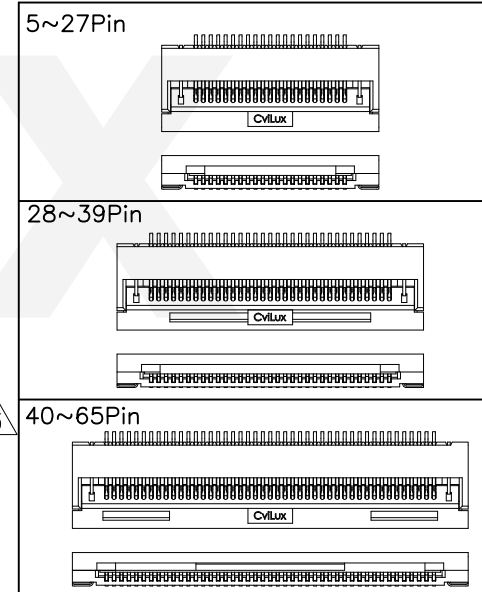

Recommended P.C. Board Layout



Halogen-Free    Lead Free Process    RoHS compliant

④					DATE	UNIT: mm / inch	TITLE: 0.50mm(.020") ZIF FFC/FPC ONE-TOUCH CONNECTOR
③	Karen	3/14-22'	ECNT122032/ECRB122004	DRAWN BY:	Karen	3/31-22'	TOLERANCE UNLESS OTHERWISE SPECIFIED
②	Sandy	2/16-16'	ECNT116028/ECRB116002	ENGINEER:	Sun	3/31-22'	
①	Enya	11/06-12	ECN12272-0/ECR12080-1	CHECKED BY:	Eisley	4/1-22'	MATERIAL:
SYM	NAME	DATE	REVISIONS	APPROVED BY:	Eisley	4/1-22'	FINISH:
							DRAWING NO. CF2520SD
							PART NO. CF25***D0*0-05-NH
							SCALE 5 / 1
							SHEET 1 OF 2



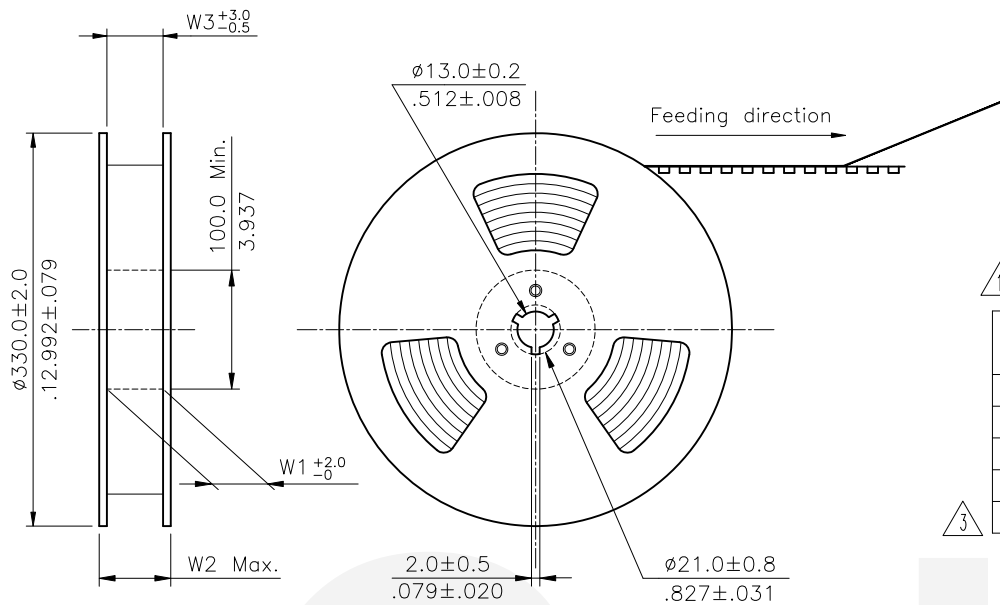

- NOTES:
- 10 sprocket hole pitch cumulative tolerance  $\pm 0.20$
  - Carrier camber is within 1 mm in 250 mm.
  - Material :Transparent Anti-static Polysyrene.
  - All dimensions meet EIA-481 requirements.
  - Thickness :  $0.35 \pm 0.05$ mm.
  - Component load per 13" Reel : 2000 pcs.

Circuits	Dimension					Packing (Reel/Carton)
	E	F	W1	W2	W3	
5-9	16.0(.630)	—	16.5(.650)	22.5(.886)	16.5(.650)	11
10-25	24.0(.945)	—	24.5(.965)	30.5(1.201)	24.5(.965)	9
26-34	32.0(1.260)	28.40(1.118)	32.5(1.280)	38.5(1.516)	32.5(1.280)	7
35-57	44.0(1.732)	40.40(1.591)	44.5(1.752)	50.5(1.988)	44.5(1.752)	5
58-65	56.0(2.205)	52.50(2.067)	56.5(2.224)	62.5(2.461)	56.5(2.224)	4

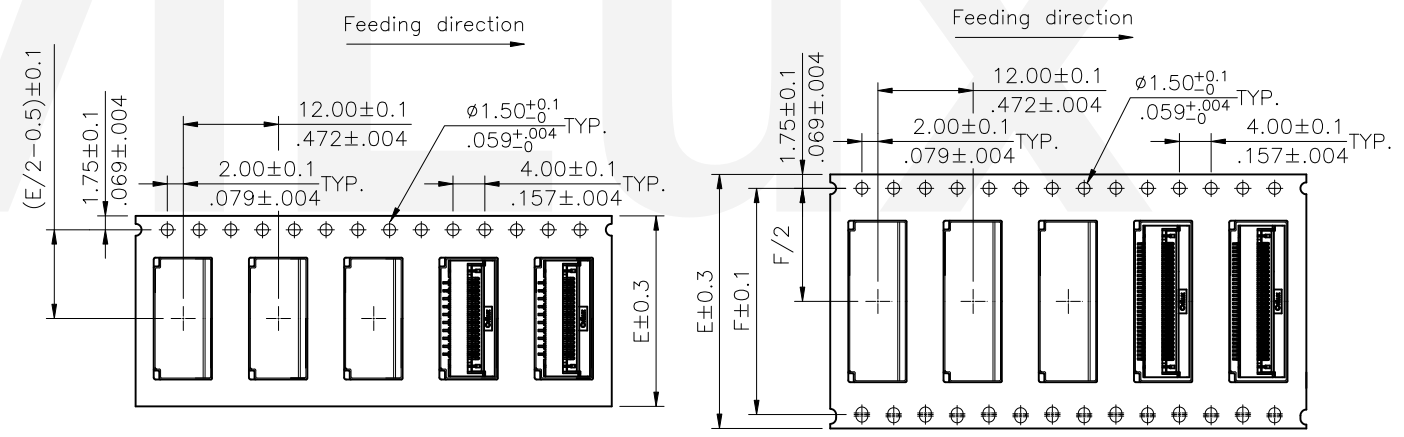
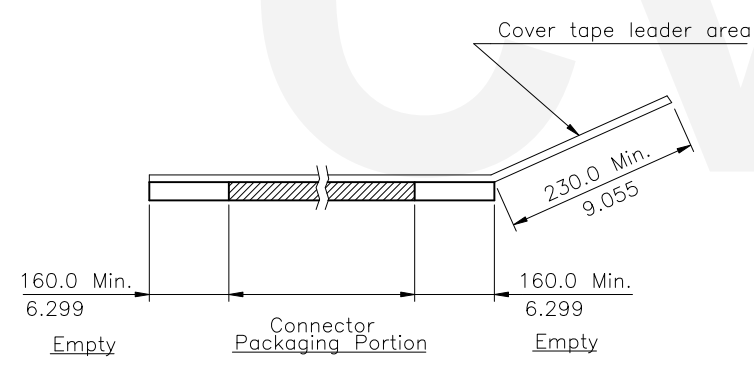

CIVILUX  
 2022.04.07  
 ISSUED

WIDTH : 16.24 mm Carrier

WIDTH : 32.44,56 mm Carrier

RoHS Compliant

4				DATE	UNIT: mm / inch		TITLE: 0.50mm(.020") ZIF FFC/FPC ONE-TOUCH CONNECTOR	MATERIAL:	FINISH:	DRAWING NO. CF2520SD	PART NO. CF25***D0*0-05-NH	
3	Karen	3/14-22'	ECNT122032/ECRB122004	DRAWN BY: Karen	3/31-22'	TOLERANCE UNLESS OTHERWISE SPECIFIED						SCALE
2	Sandy	2/16-16'	ECNT116028/ECRB116002	ENGINEER: Sun	3/31-22'	.X ±	.X' ± 1"					
1	Enya	11/06-12	ECN12272-0/ECR12080-1	CHECKED BY: Eisley	4/1-22'	.XX ±	.X ±					
SYM	NAME	DATE	REVISIONS	APPROVED BY: Eisley	4/1-22'	.XXX ±	.XX ±					

