

THIS DRAWING IS SUPPLIED FOR INFORMATION ONLY. DESIGN FEATURES, SPECIFICATIONS AND PERFORMANCE DATA SHOWN HEREON ARE THE PROPERTY OF THE AMPHENOL CORPORATION. NO RIGHTS OF REPRODUCTION ARE IMPLIED. ALL DIMENSIONS ARE SUBJECT TO NORMAL MANUFACTURING VARIATIONS.

Customer Drawing

REVISIONS						
REV	ZONE	ECO	DESCRIPTION	DATE	BY	APPR
A	--	--	INITIAL RELEASE	2019/11/20	RJ	JL
B	--	ECNG200405	update drawing	2020/04/08	RJ	JL

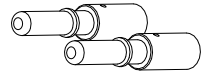
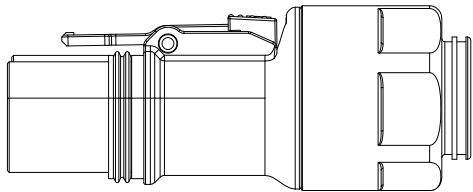

Standard Part List

P/N	Model NO.
AC-HA014027	PL1824X-40-10-CA
AC-HA014028	PL1824Y-40-10-CA
AC-HA014029	PL1824U-40-10-CA

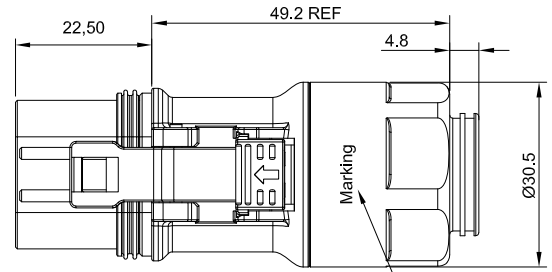

Marking Details See Spec ND.12

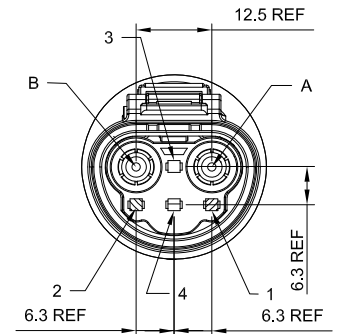
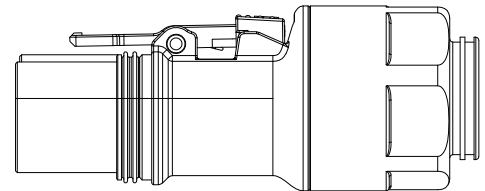
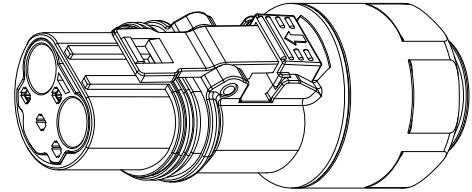

Pin Order View

Order Information

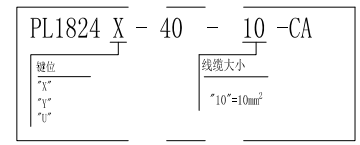

规格参数 (Spec.):

- 工作温度 Operating temperature: -40° C~+125° C.
- 额定电流 Current rating:
Power Contact 50 A within -40°C~+90°C for pin A and B ;
- 额定电压 Operating voltage:
Power pins 1000 VDC
- 耐电压 Dielectric withstanding voltage:
Power pins 5000 VDC
- 绝缘电阻 Insulation Resistance:
100MΩ at 500 V D.C.
- 防护等级 Protection class: IP67.
- 电磁屏蔽 Shielding.
- 机械寿命 Mating cycle: 100 Min.
- 对配插座见图纸 Mating receptacle see drawing: "PL0824()-40-10-CA".
- 接非屏蔽线 Accepte Unshielding Wire.
- 印字内容 Marking
- 胶芯材料 Insulation Material: PA66
颜色 Color: Black
- 阻燃等级 Flammability: UL94 V-0

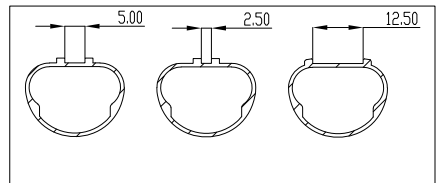

Marking

AMPHENOL
 PL1824(X)-40-10-CA
 UL94 V-0
 1000VDC 50A
 YYWW
 XXXXXXXX

	Amphenol Technical Products International Asia.					
	第三角投影 THIRD ANGLE PROJECTION	页面 SHEET	幅面 SIZE	版次 REV.	比例 SCALE	PART NAME: PL 3.6 2+4 CONM PLUG ASM.
		1 of 1	A3	B		DWG NO: PL1824()-40-10-CA
签名 SIGNATURE	日期 DATE	UNLESS OTHERWISE SPECIFIED			1) All dimensions are in metric(mm). 2) Tolerances are as follows: 0 PL DEC ±1.00 1 PL DEC ±0.50 2 PL DEC ±0.20 Angles ±1°	
制图 DRAWN Robert.Jing	2020/04/08					
审核 CHECKED Steven.Tan	2020/04/08					
批准 APPROVAL James.Li	2020/04/08					
					CUST PART #: N/A	CUST REV.