

**SIPMOS® Small-Signal Transistor**

- N channel
- Enhancement mode
- Avalanche rated
- $V_{GS(th)} = 2.1 \dots 4.0 \text{ V}$
- Pb-free lead plating; RoHS compliant
- Qualified according to AEC Q101
- Halogen-free according to IEC 61249-2-21

drain pins 2, 4

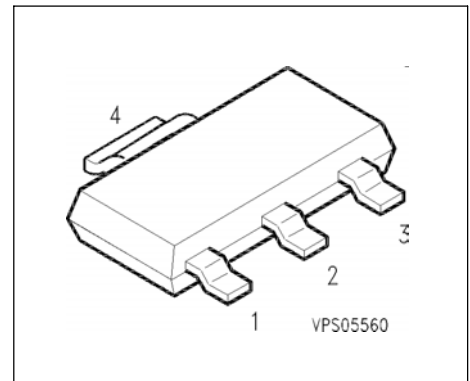

Pin 1	Pin 2	Pin 3	Pin 4
G	D	S	D



Type	$V_{DS}$	$I_D$	$R_{DS(on)}$	Package	Marking
BSP298	400 V	0.5 A	3 $\Omega$	PG-SOT223	BSP298

Type	Pb-free	Tape and Reel Information	Packaging
BSP298	Yes	H6327	Dry

**Maximum Ratings**

Parameter	Symbol	Values	Unit
Continuous drain current $T_A = 26 \text{ }^\circ\text{C}$	$I_D$	0.5	A
DC drain current, pulsed $T_A = 25 \text{ }^\circ\text{C}$	$I_{Dpuls}$	2	A
Avalanche energy, single pulse $I_D = 1.35 \text{ A}$ , $V_{DD} = 50 \text{ V}$ , $R_{GS} = 25 \text{ } \Omega$ $L = 125 \text{ mH}$ , $T_j = 25 \text{ }^\circ\text{C}$	$E_{AS}$	130	mJ
Gate source voltage	$V_{GS}$	$\pm 20$	V
Power dissipation $T_A = 25 \text{ }^\circ\text{C}$	$P_{tot}$	1.8	W
ESD Class JESD22-A114-HBM		Class 1b	

**Maximum Ratings**

Parameter	Symbol	Values	Unit
Chip or operating temperature	$T_j$	-55 ... + 150	°C
Storage temperature	$T_{stg}$	-55 ... + 150	
Thermal resistance, chip to ambient air	$R_{thJA}$	≤ 70	K/W
Thermal resistance, junction-soldering point <sup>1)</sup>	$R_{thJS}$	≤ 10	
DIN humidity category, DIN 40 040		E	
IEC climatic category, DIN IEC 68-1		55 / 150 / 56	

1) Transistor on epoxy pcb 40 mm x 40 mm x 1,5 mm with 6 cm<sup>2</sup> copper area for drain connection

**Electrical Characteristics, at  $T_j = 25^\circ\text{C}$ , unless otherwise specified**

Parameter	Symbol	Values			Unit
		min.	typ.	max.	

**Static Characteristics**

Drain- source breakdown voltage $V_{GS} = 0 \text{ V}, I_D = 0.25 \text{ mA}, T_j = 0^\circ\text{C}$	$V_{(BR)DSS}$	400	-	-	V
Gate threshold voltage $V_{GS}=V_{DS}, I_D = 1 \text{ mA}$	$V_{GS(th)}$	2.1	3	4	
Zero gate voltage drain current $V_{DS} = 400 \text{ V}, V_{GS} = 0 \text{ V}, T_j = 25^\circ\text{C}$ $V_{DS} = 400 \text{ V}, V_{GS} = 0 \text{ V}, T_j = 125^\circ\text{C}$	$I_{DSS}$	-	0.1 10	1 100	μA
Gate-source leakage current $V_{GS} = 20 \text{ V}, V_{DS} = 0 \text{ V}$	$I_{GSS}$	-	10	100	nA
Drain-Source on-state resistance $V_{GS} = 10 \text{ V}, I_D = 0.5 \text{ A}$	$R_{DS(on)}$	-	2.2	3	Ω

**Electrical Characteristics, at  $T_j = 25^\circ\text{C}$ , unless otherwise specified**

Parameter	Symbol	Values			Unit
		min.	typ.	max.	
<b>Dynamic Characteristics</b>					
Transconductance $V_{DS} \geq 2 \cdot I_D \cdot R_{DS(on)max}$ , $I_D = 0.5 \text{ A}$	$g_{fs}$	0.5	1.2	-	S
Input capacitance $V_{GS} = 0 \text{ V}$ , $V_{DS} = 25 \text{ V}$ , $f = 1 \text{ MHz}$	$C_{iss}$	-	300	400	pF
Output capacitance $V_{GS} = 0 \text{ V}$ , $V_{DS} = 25 \text{ V}$ , $f = 1 \text{ MHz}$	$C_{oss}$	-	50	75	
Reverse transfer capacitance $V_{GS} = 0 \text{ V}$ , $V_{DS} = 25 \text{ V}$ , $f = 1 \text{ MHz}$	$C_{rss}$	-	20	30	
Turn-on delay time $V_{DD} = 30 \text{ V}$ , $V_{GS} = 10 \text{ V}$ , $I_D = 0.3 \text{ A}$ $R_{GS} = 50 \Omega$	$t_{d(on)}$	-	10	15	ns
Rise time $V_{DD} = 30 \text{ V}$ , $V_{GS} = 10 \text{ V}$ , $I_D = 0.3 \text{ A}$ $R_{GS} = 50 \Omega$	$t_r$	-	25	40	
Turn-off delay time $V_{DD} = 30 \text{ V}$ , $V_{GS} = 10 \text{ V}$ , $I_D = 0.3 \text{ A}$ $R_{GS} = 50 \Omega$	$t_{d(off)}$	-	30	40	
Fall time $V_{DD} = 30 \text{ V}$ , $V_{GS} = 10 \text{ V}$ , $I_D = 0.3 \text{ A}$ $R_{GS} = 50 \Omega$	$t_f$	-	20	30	

**Electrical Characteristics**, at  $T_j = 25^\circ\text{C}$ , unless otherwise specified

Parameter	Symbol	Values			Unit
		min.	typ.	max.	
<b>Reverse Diode</b>					
Inverse diode continuous forward current $T_A = 25^\circ\text{C}$	$I_S$	-	-	0.5	A
Inverse diode direct current, pulsed $T_A = 25^\circ\text{C}$	$I_{SM}$	-	-	2	
Inverse diode forward voltage $V_{GS} = 0\text{ V}$ , $I_F = 1\text{ A}$ , $T_j = 25^\circ\text{C}$	$V_{SD}$	-	0.95	1.2	V
Reverse recovery time $V_R = 100\text{ V}$ , $I_F = I_S$ , $di_F/dt = 100\text{ A}/\mu\text{s}$	$t_{rr}$	-	300	-	ns
Reverse recovery charge $V_R = 100\text{ V}$ , $I_F = I_S$ , $di_F/dt = 100\text{ A}/\mu\text{s}$	$Q_{rr}$	-	2.5	-	$\mu\text{C}$

**Power dissipation**

$$P_{tot} = f(T_A)$$

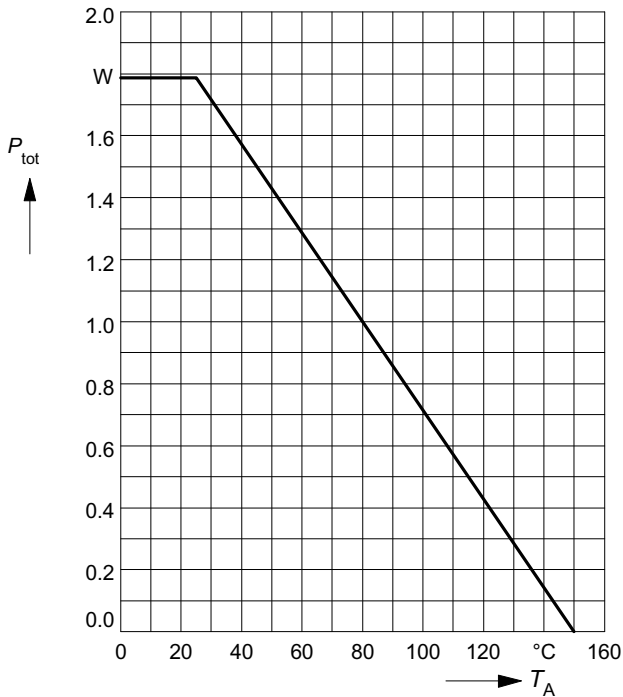

**Drain current**

$$I_D = f(T_A)$$

parameter:  $V_{GS} \geq 10 \text{ V}$

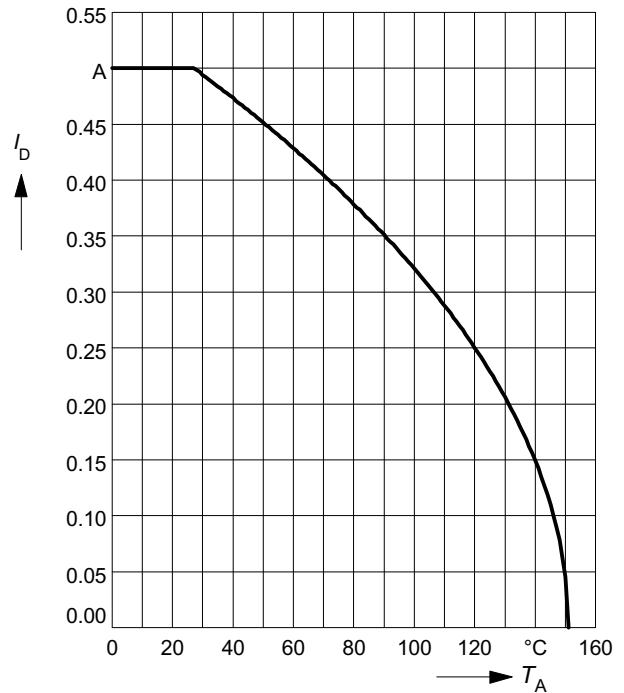

**Safe operating area  $I_D = f(V_{DS})$**

parameter :  $D = 0, T_C = 25^\circ\text{C}$

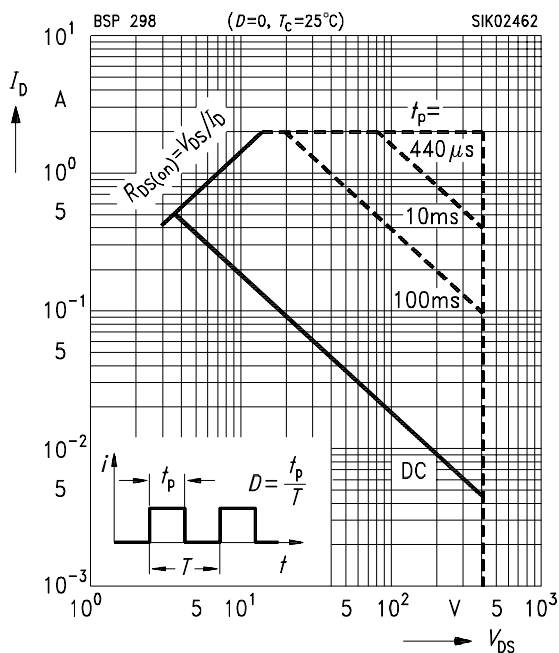

**Transient thermal impedance**

$$Z_{th\text{JA}} = f(t_p)$$

parameter:  $D = t_p / T$

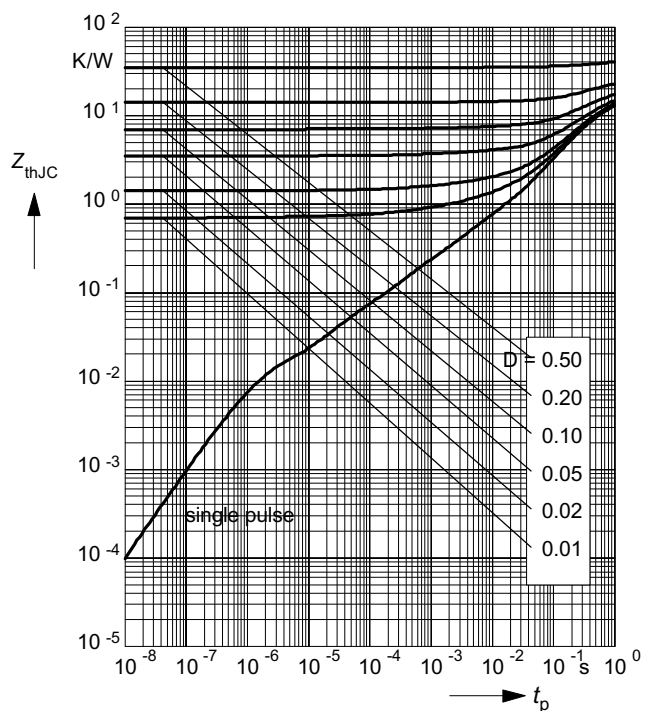

**Typ. output characteristics**

$I_D = f(V_{DS})$

parameter:  $t_p = 80 \mu s$ ,  $T_j = 25 \text{ }^\circ\text{C}$

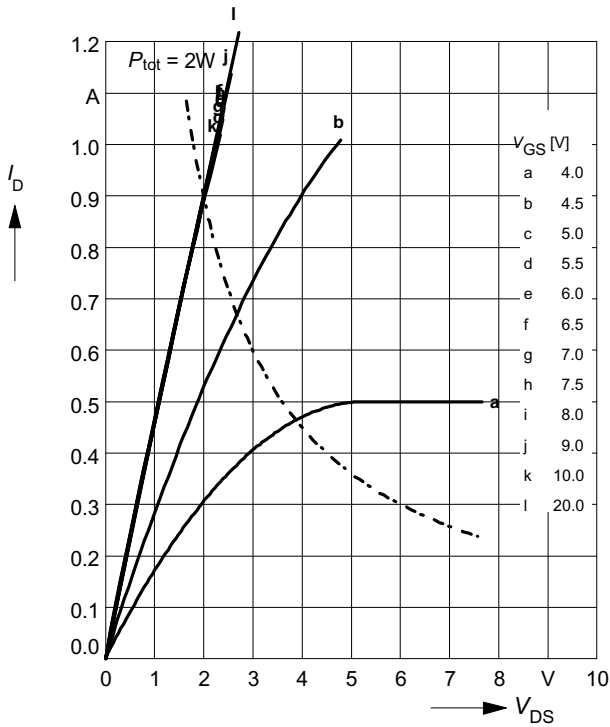

**Typ. drain-source on-resistance**

$R_{DS(on)} = f(I_D)$

parameter:  $t_p = 80 \mu s$ ,  $T_j = 25 \text{ }^\circ\text{C}$

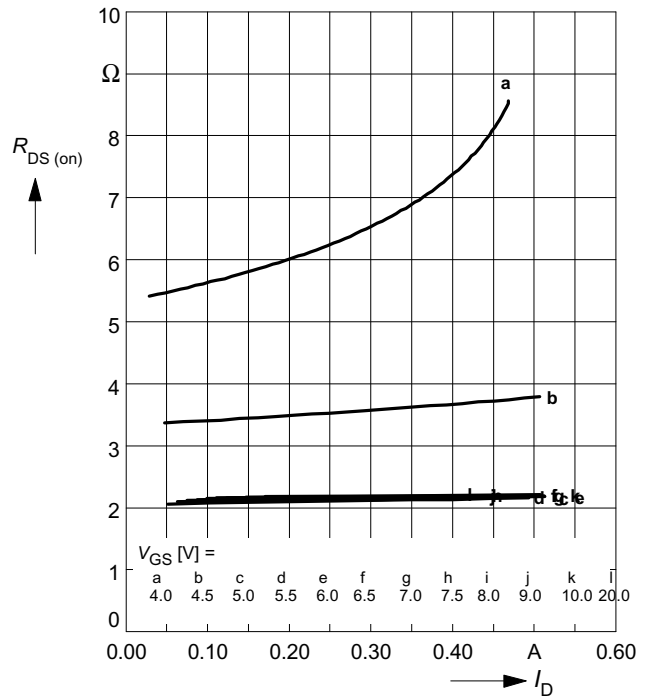

**Typ. transfer characteristics  $I_D = f(V_{GS})$**

parameter:  $t_p = 80 \mu s$

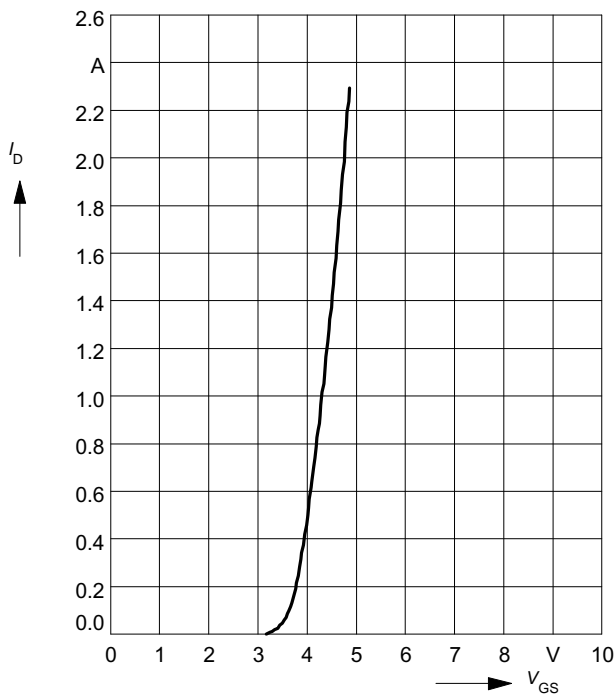

**Typ. forward transconductance  $g_{fs} = f(I_D)$**

parameter:  $t_p = 80 \mu s$ ,

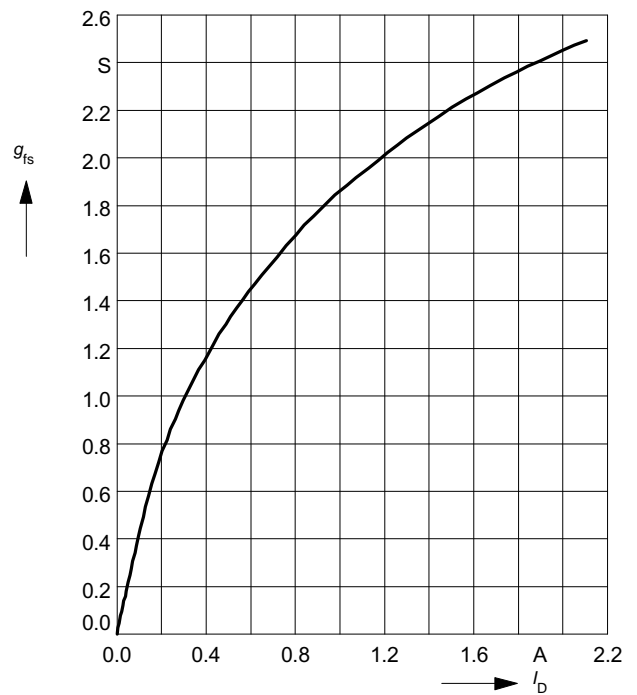

**Drain-source on-resistance**

$$R_{DS(on)} = f(T_j)$$

parameter:  $I_D = 0.5 \text{ A}$ ,  $V_{GS} = 10 \text{ V}$

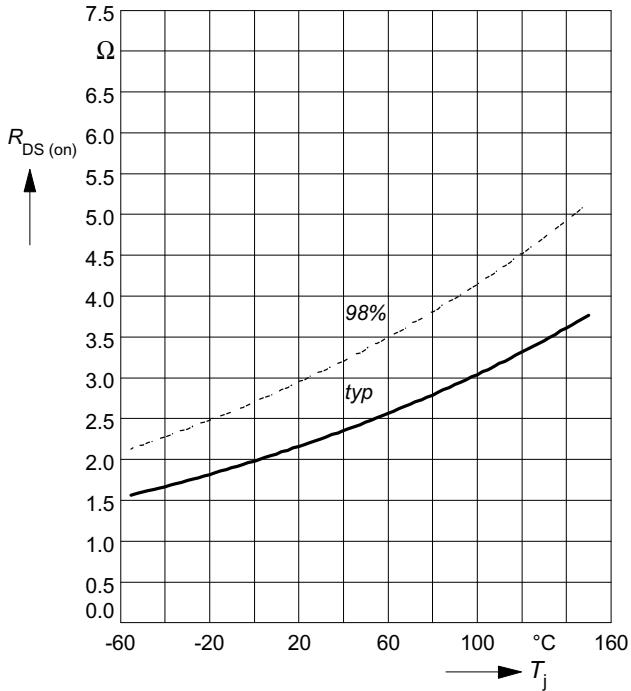

**Gate threshold voltage**

$$V_{GS(th)} = f(T_j)$$

parameter:  $V_{GS} = V_{DS}$ ,  $I_D = 1 \text{ mA}$

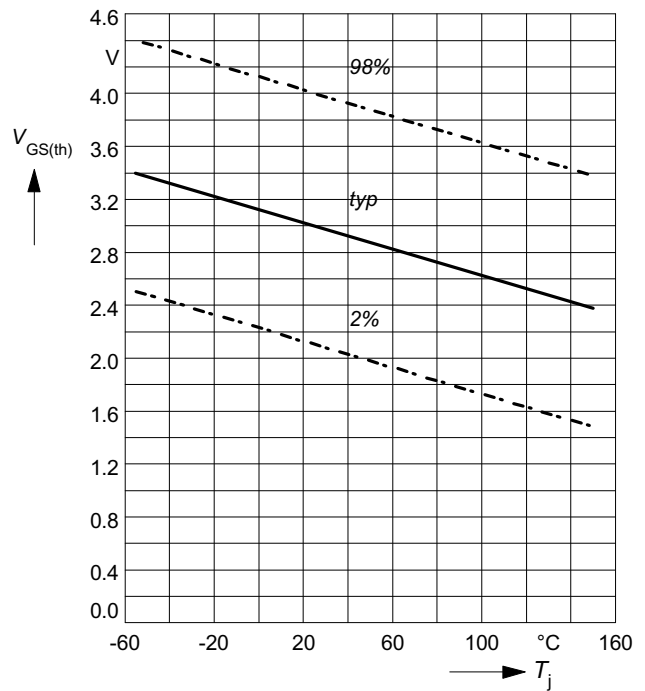

**Typ. capacitances**

$$C = f(V_{DS})$$

parameter:  $V_{GS}=0\text{V}$ ,  $f = 1 \text{ MHz}$

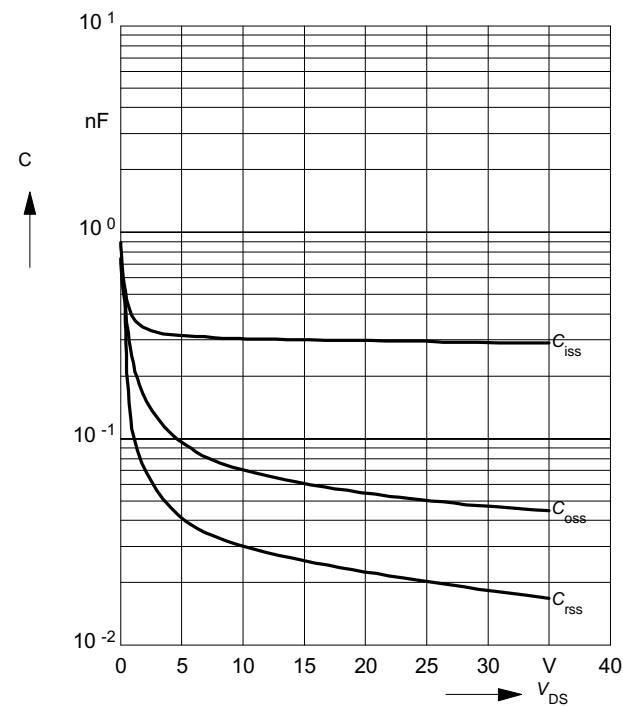

**Forward characteristics of reverse diode**

$$I_F = f(V_{SD})$$

parameter:  $T_j, t_p = 80 \mu\text{s}$

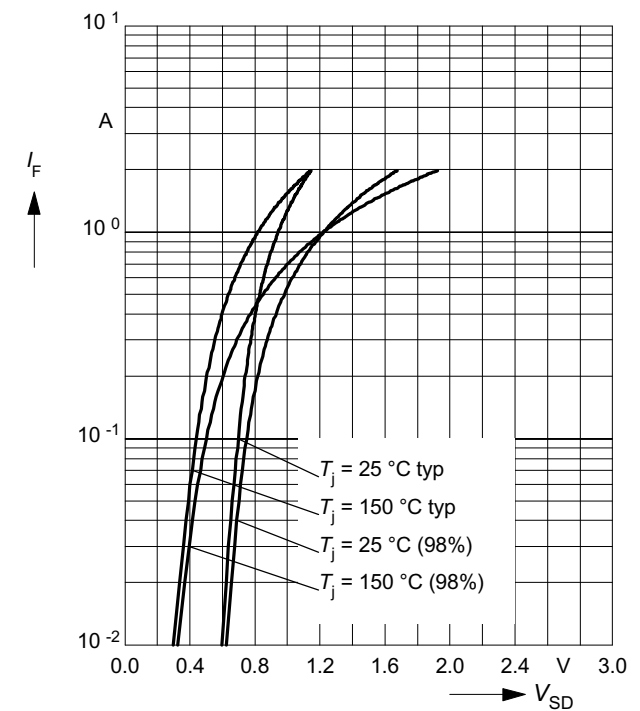

**Avalanche energy**  $E_{AS} = f(T_j)$   
 parameter:  $I_D = 1.35\text{ A}$ ,  $V_{DD} = 50\text{ V}$   
 $R_{GS} = 25\ \Omega$ ,  $L = 125\text{ mH}$

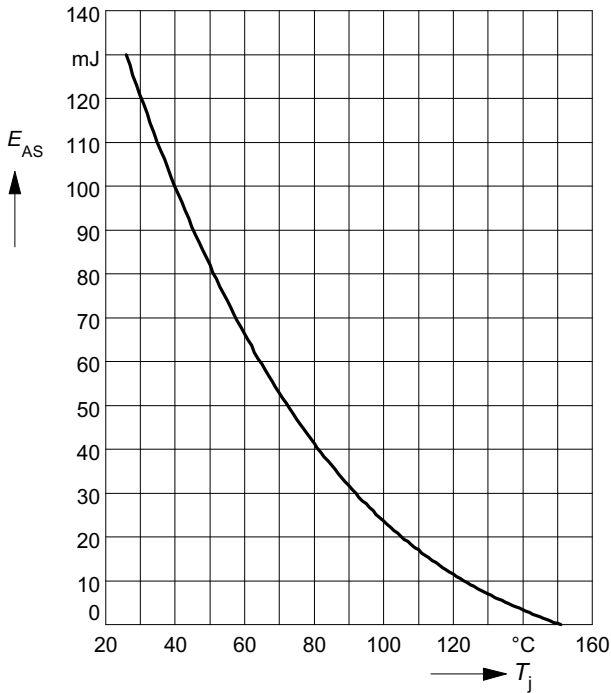

**Drain-source breakdown voltage**  
 $V_{(BR)DSS} = f(T_j)$

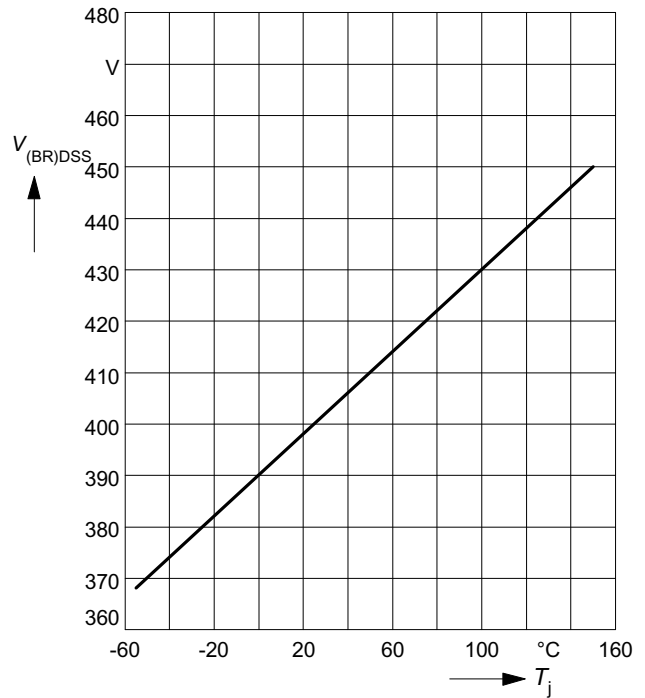

**Safe operating area**  $I_D = f(V_{DS})$   
 parameter :  $D = 0.01$ ,  $T_C = 25^\circ\text{C}$

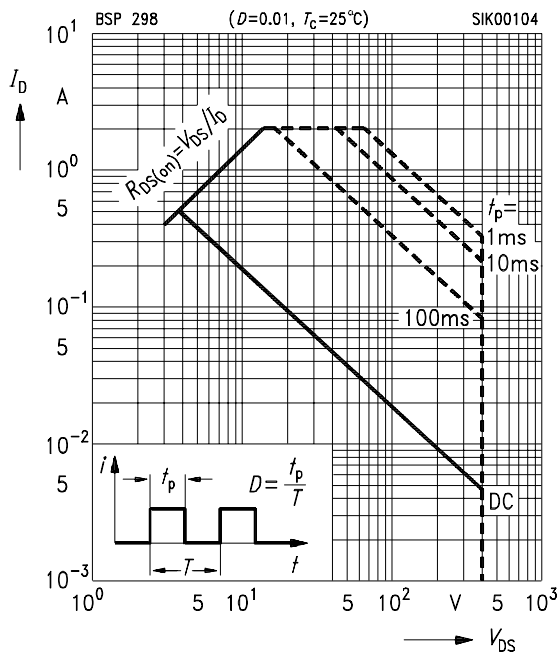



**Package outlines**

SOT-223

Dimensions in mm

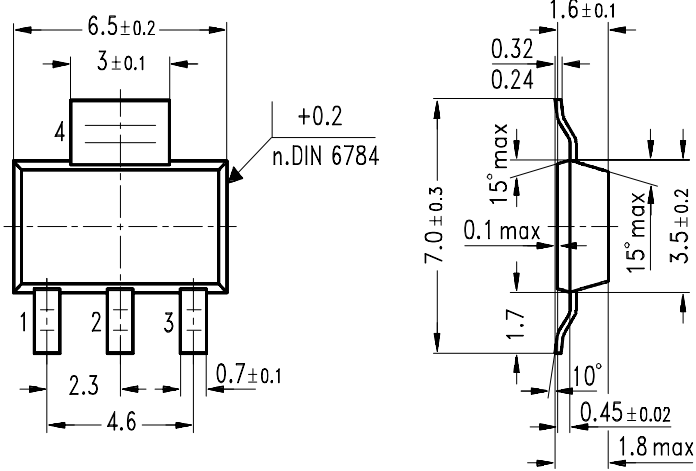

GPS05560

**Published by**  
**Infineon Technologies AG**  
**81726 Munich, Germany**  
**© 2008 Infineon Technologies AG**  
**All Rights Reserved.**

#### **Legal Disclaimer**

The information given in this document shall in no event be regarded as a guarantee of conditions or characteristics. With respect to any examples or hints given herein, any typical values stated herein and/or any information regarding the application of the device, Infineon Technologies hereby disclaims any and all warranties and liabilities of any kind, including without limitation, warranties of non-infringement of intellectual property rights of any third party.

#### **Information**

For further information on technology, delivery terms and conditions and prices, please contact the nearest Infineon Technologies Office ([www.infineon.com](http://www.infineon.com)).

#### **Warnings**

Due to technical requirements, components may contain dangerous substances. For information on the types in question, please contact the nearest Infineon Technologies Office. Infineon Technologies components may be used in life-support devices or systems only with the express written approval of Infineon Technologies, if a failure of such components can reasonably be expected to cause the failure of that life-support device or system or to affect the safety or effectiveness of that device or system. Life support devices or systems are intended to be implanted in the human body or to support and/or maintain and sustain and/or protect human life. If they fail, it is reasonable to assume that the health of the user or other persons may be endangered.