

RF to IF Dual Downconverting Mixer

1400 - 2200 MHz F1152NBGI

GENERAL DESCRIPTION

This document describes the specifications for the IDTF1152 Zero-Distortion™ RF to IF Downconverting Mixer. This device is part of a series of mixers offered with high side or low side injection options for all UTRA bands. See the Part# Matrix for the details of all devices in this series.

The F1152 dual channel device is designed to operate with a single 5V supply. It is optimized for operation in a Multi-mode, Multi-carrier BaseStation Receiver for RF bands from 1700 - 2200 MHz with Low Side Injection or from 1400 to 1700 MHz with High Side Injection. IF frequencies from 50 to 350 MHz are supported. Nominally, the device offers +43 dBm Output IP3 with 327 mA of I_{CC} . Alternately one can adjust 4 resistor values and a toggle pin to run the device in low current mode with +40 dBm Output IP3 and 232 mA of I_{CC} .

COMPETITIVE ADVANTAGE

In typical basestation receivers the RF to IF mixer dominates the linearity performance for the entire receive system. The Zero-Distortion™ family of mixers dramatically improve the maximum signal levels (IM_3 tones) that the BTS can withstand at a desired Signal to Noise Ratio (SNR.) Alternately, one can run the device in Low Current Mode to reduce Power consumption significantly. Zero-Distortion™ technology allows realization of either benefit.

- ✓ $IP3_0$: \uparrow **9 dB** STD Mode, \uparrow **6 dB** LC Mode
- ✓ Dissipation: \downarrow **40%** LC Mode, \downarrow **12%** STD Mode
- ✓ Allows for higher RF gain improving **Sensitivity**



PART# MATRIX

| Part# | RF freq range | UTRA bands | IF freq range | Typ. Gain | Injection |
|--------------|--------------------|--|-----------------|------------|-----------------|
| F1100 | 698 - 915 | 5,6,8,12,13,14,17,19,20 | 50 - 450 | 8.5 | High Side |
| F1102 | 698 - 915 | 5,6,8,12,13,14,17,19,20 | 50 - 250 | 8.5 | Both |
| F1150 | 1700 - 2200 | 1,2,3,4,9,10,33,34,35,36,37,39 | 50 - 450 | 8.5 | High Side |
| F1152 | 1400 - 2200 | 1,2,3,4,9,10,11¹,21¹,24¹,33,34,35,36,37,39 | 50 - 350 | 8.5 | Low Side |
| F1162 | 2300 - 2700 | 7,38,40,41 | 50 - 500 | 8.9 | Both |

1 - with High side injection

FEATURES

- Dual Path for Diversity Systems
- Ideal for Multi-Carrier Systems
- 8.5 dB Gain
- Ultra linear **+43 dBm $IP3_0$**
- Low NF < 10 dB
- 200 Ω output impedance
- Ultra high +13 dBm $P1dB_1$
- **Pin Compatible** w/existing solutions
- 6x6 36 pin package
- **Power Down mode**
- < 200 nsec settling from Power Down
- Minimizes Synth pulling in Standby Mode
- Low Current Mode : $I_{CC} = 232$ mA
- Standard Mode: $I_{CC} = 327$ mA
- NOTE production BOM on p. 20

DEVICE BLOCK DIAGRAM

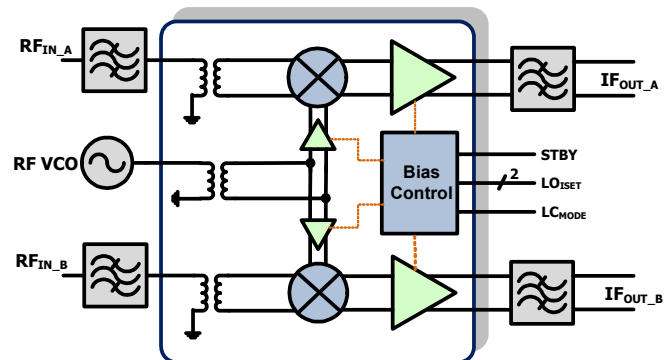

ORDERING INFORMATION

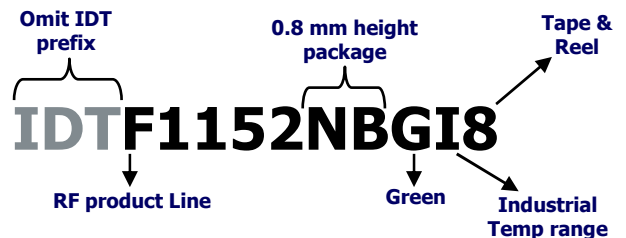

ABSOLUTE MAXIMUM RATINGS

| | |
|---|------------------------------------|
| VCC to GND | -0.3V to +5.5V |
| STBY, LC _{MODE} | -0.3V to (VCC ₋ + 0.3V) |
| IF_A+, IF_B+, IF_A-, IF_B-, LO1_ADJ, LO2_ADJ | -0.3V to (VCC ₋ + 0.3V) |
| LO_IN, LO_IN_ALT, RF_A, RF_B | -0.3V to +0.3V |
| IF_BiasA, IF_BiasB to GND | -0.3V to +0.3V |
| RF Input Power (RF_IN[A+, A-, B+, B-]) | +20dBm |
| Continuous Power Dissipation | 2.2W |
| θ_{JA} (Junction – Ambient) | +35°C/W |
| θ_{JC} (Junction – Case) The Case is defined as the exposed paddle | +2.5°C/W |
| Operating Temperature Range (Case Temperature) | T _C = -40°C to +100°C |
| Maximum Junction Temperature | 150°C |
| Storage Temperature Range | -65°C to +150°C |
| Lead Temperature (soldering, 10s) . | +260°C |

Stresses above those listed above may cause permanent damage to the device. Functional operation of the device at these or any other conditions above those indicated in the operational section of this specification is not implied. Exposure to absolute maximum rating conditions for extended periods may affect device reliability.

RF to IF Dual Downconverting Mixer
1400 - 2200 MHz F1152NBGI
IDTF1152 SPECIFICATION

Specifications apply at $V_{CC} = +5.00V$, $T_C = +25^\circ C$, $F_{RF} = 1850 \text{ MHz}$, $F_{IF} = 200\text{MHz}$, $P_{LO} = 0 \text{ dBm}$, $STBY = GND$, $LC_{MODE} = V_{IH}$ (STD Mode), EVKit BOM = Standard Mode, Transformer Loss included (not de-embedded) unless otherwise noted.

| Parameter | Comment | Symbol | min | typ | max | units |
|-----------------------------|--|------------------|-------------|--------------|------------------------|-----------|
| Logic Input High | For Standby, LC_{MODE} Pins | V_{IH} | 2 | | | V |
| Logic Input Low | For Standby, LC_{MODE} Pins | V_{IL} | | | 0.8 | V |
| Logic Current | For Standby, LC_{MODE} Pins | I_{IH}, I_{IL} | -100 | | -20 | μA |
| Supply Voltage(s) | All V_{CC} pins | V_{CC} | | 4.75 to 5.25 | | V |
| Operating Temperature Range | Case Temperature | T_{CASE} | | -40 to +100 | | degC |
| Supply Current | Total V_{CC} , STD Mode ▪ Total Both Channels | I_{STD} | | 327 | 380¹ | mA |
| Supply Current | Total V_{CC} , LC Mode ▪ $LC_{MODE} = GND$ ▪ EVkit BOM = LC Mode ▪ Total Both Channels | I_{LC} | | 232 | 260 | mA |
| Supply Current | Standby Mode ▪ $STBY = V_{IH}$ ▪ Total Both Channels | I_{STBY} | | 17 | 26 | mA |
| RF Freq Range | Operating Range (low side injection) | F_{RF} | | 1700 to 2200 | | MHz |
| RF Freq Range | Operating Range (hi-side inj. with RF match p. 20) | | | 1400 - 1700 | | MHz |
| IF Freq Range | Operating Range | F_{IF} | | 50 to 350 | | MHz |
| LO Freq Range | Low Side Injection | F_{LO} | | 1350 to 2100 | | MHz |
| LO Power | | P_{LO} | | -3 to +6 | | dBm |
| RF Input Impedance | Single Ended Return Loss ~17 dB | Z_{RF} | | 50 | | Ω |
| IF Output Impedance | Differential Return Loss ~ 13 dB | Z_{IF} | | 200 | | Ω |
| LO port Impedance | Single Ended Return Loss ~15 dB | Z_{LO} | | 50 | | Ω |
| Settling Time | • Pin = -13 dBm • Gate STBY from V_{IH} to V_{IL} • Time for IF Signal to settle to within 0.1 dB of final value | T_{SETT} | | 0.155 | | μsec |
| Gain STD Mode | Conversion Gain • $F_{RF} = 1710 \text{ MHz}$ • $LC_{MODE} = V_{IH}$ • EVkit BOM = STD Mode • $F_{IF} = 200 \text{ MHz}$ | G_{STD} | 7.6 | 8.5 | 9.5 | dB |

IDTF1152 SPECIFICATION (CONTINUED)

| Parameter | Comment | Symbol | min | typ | max | units |
|--------------------------------|---|-----------------|-----------------|-------------|------------|-------|
| Gain LC Mode | Conversion Gain • $F_{RF} = 2050$ MHz • $LC_{MODE} = GND$ • EVkit BOM = LC Mode • $F_{IF} = 200$ MHz | G_{LC} | 7.1 | 8.0 | 9.1 | dB |
| NF STD Mode | Noise Figure | NF_{STD} | | 10 | | dB |
| NF LC Mode | Noise Figure • $LC_{MODE} = GND$ • EVkit BOM = LC Mode • $F_{IF} = 200$ MHz | NF_{LC} | | 9.6 | | dB |
| NF w/Blocker | ▪ +100 MHz offset blocker ▪ $P_{IN} = +4$ dBm ▪ $F_{IF} = 250$ MHz | NF_{BLK} | | 16.5 | | dB |
| Output IP3 – Narrowband | ▪ $P_{IN} = -5$ dBm per tone ▪ 800 KHz Tone Separation | $IP3_{O1}$ | 39 ² | 43 | | dBm |
| Output IP3 – Wideband | ▪ $P_{IN} = -5$ dBm per tone ▪ 30 MHz Tone Separation | $IP3_{O2}$ | | 42 | | dBm |
| Output IP3 – LC_{MODE} | ▪ $P_{IN} = -10$ dBm per tone ▪ $F_{IF} = 200$ MHz ▪ 800 KHz Tone Separation ▪ $LC_{MODE} = GND$ ▪ EVKit BOM = LC Mode | $IP3_{O3}$ | 36 | 41 | | dBm |
| 2RF – 2LO rejection | ▪ $P_{RF} = -10$ dBm ▪ Frequency = $F_{RF} - \frac{1}{2} F_{IF}$ | 2x2 | | -72 | | dBc |
| 1 dB Compression | ▪ Input referred | $P1dB_{I1}$ | 11.5 | 13.2 | | dBm |
| 1 dB Compression - LC_{MODE} | ▪ Input referred ▪ $LC_{MODE} = GND$ ▪ EVKit BOM = LC Mode ▪ $F_{IF} = 200$ MHz | $P1dB_{I2}$ | 8 | 10.8 | | dBm |
| Gain Comp. w/blocker | ▪ Blocker → unmodulated tone ▪ $P_{IN} = +8$ dBm, -100 MHz offset ▪ Signal Pin Tone = -20 dBm ▪ Measure ΔG of signal ▪ $F_{IF} = 250$ MHz | ΔG_{AC} | | 0.15 | | dB |
| Channel Isolation | IF_B Pout vs. IF_A w/ RF_A input | ISO_C | 45 | 49 | | dB |
| LO to IF leakage | | ISO_{LI} | | -22 | -15 | dBm |
| RF to IF leakage | $P_{in} = -10$ dBm | ISO_{RI} | | -32 | -25 | dBm |
| LO to RF leakage | | ISO_{LR} | | -40 | | dBm |

1 – Items in min/max columns in **bold italics** are Guaranteed by Test

2 – All other Items in min/max columns are Guaranteed by Design Characterization

TYPICAL OPERATING CONDITIONS

Unless otherwise Noted, the following Apply to the Typ Ops Graphs

- Low Side Injection, 200 MHz IF, 800 KHz Tone Spacing
- RF frequency = 1850 MHz for single point measurements
- Average of Channel A & Channel B
- Pin = - 10 dBm (all graphs, note exception immediately below)
- Pin = -5 dBm (STD Mode IP3 Traces)
- LO port = Pin 19 (Main Port)
- Listed Temperatures are Case Temperature (T_C = Case Temperature)
- Where noted, T_A or T_{AMB} = Ambient Temperature

TYPICAL OPERATING CONDITIONS (-1-)

Gain vs. T_{CASE}

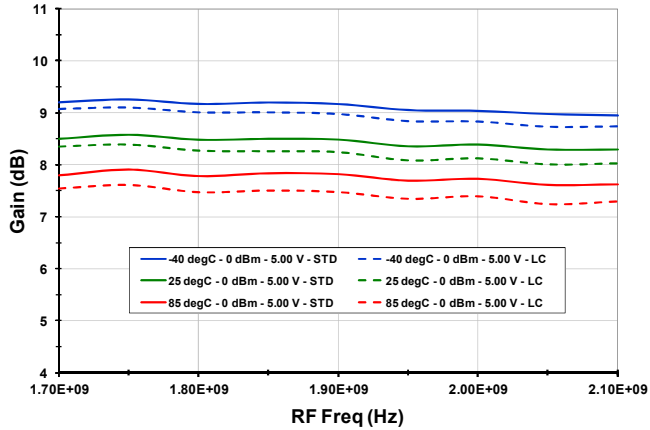

Gain vs. V_{CC}

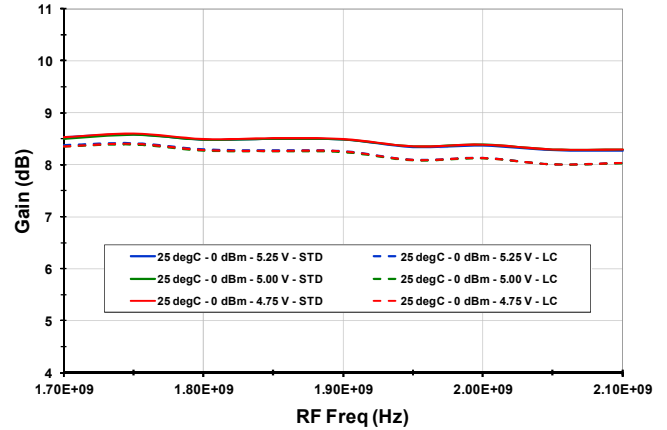

Gain vs. LO Level

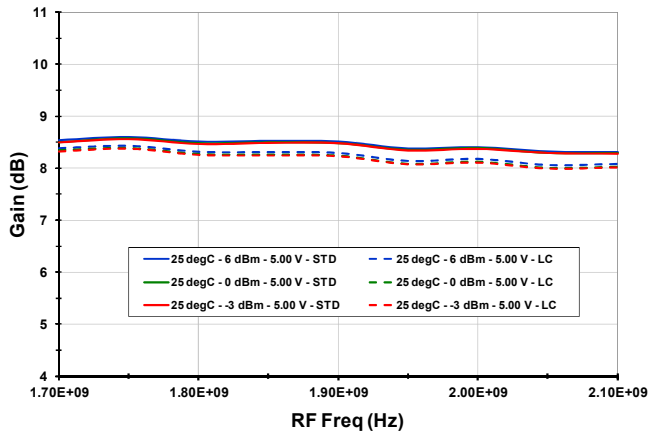

Output IP3 vs. T_{CASE}

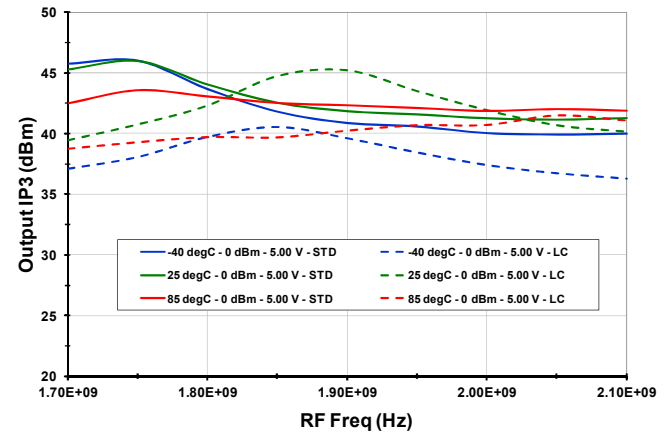

Output IP3 vs. V_{CC}

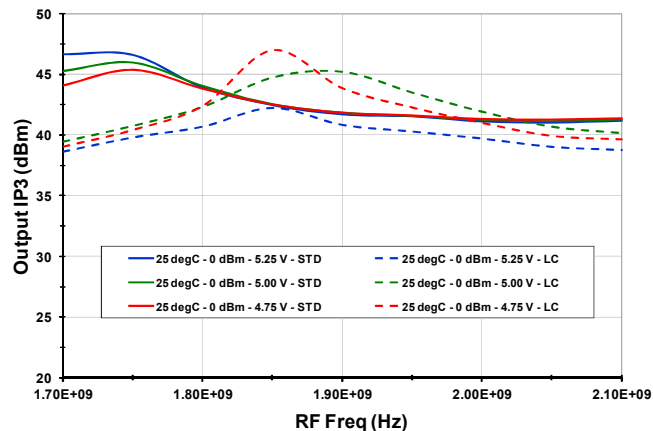

Output IP3 vs. LO Level

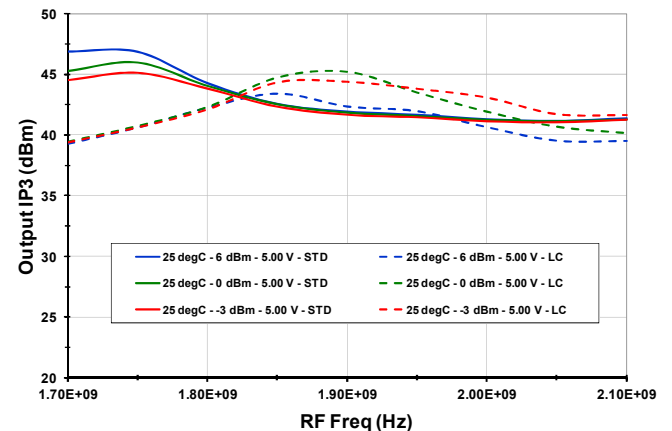

RF to IF Dual Downconverting Mixer

1400 - 2200 MHz F1152NBGI

TYPICAL OPERATING CONDITIONS (-2-)

P1dB vs. T_{CASE}

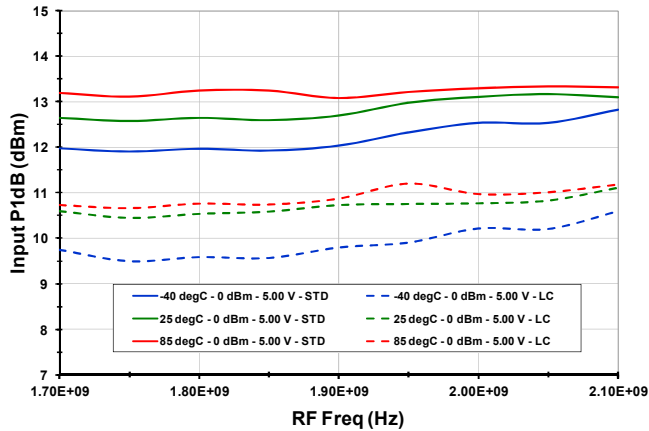

P1dB vs. V_{CC}

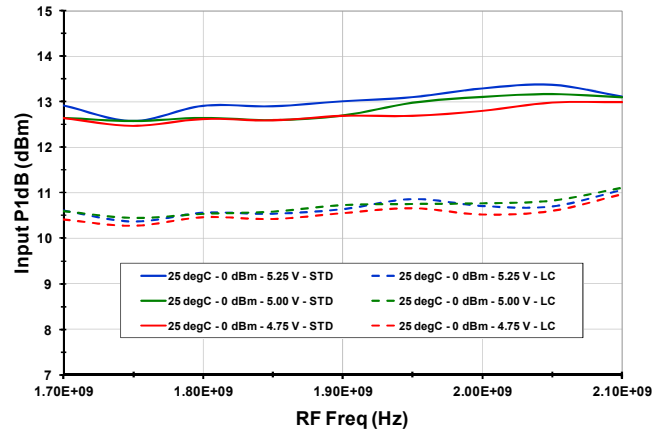

P1dB vs. LO Level

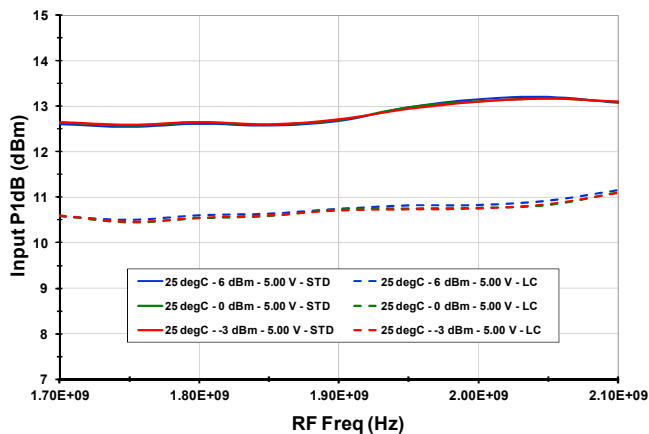

2RF x 2LO rejection vs. T_{CASE}

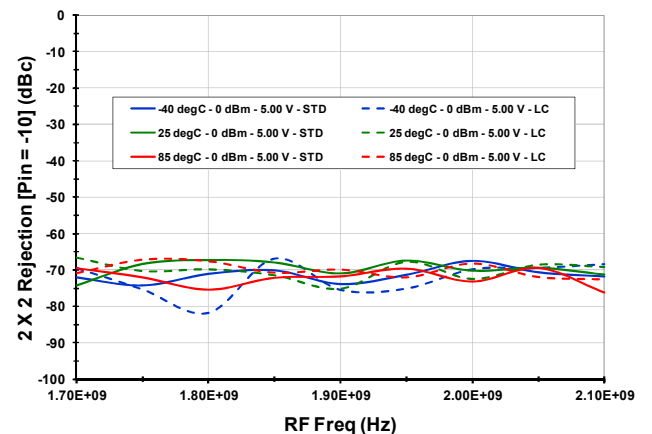

2RF x 2LO Rejection vs. V_{CC}

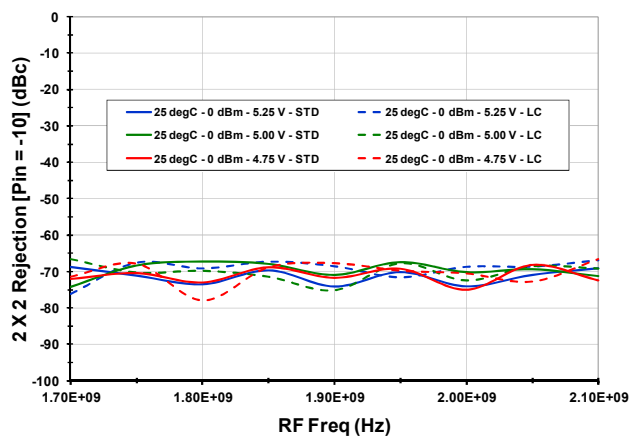

2RF x 2LO rejection vs. LO Level

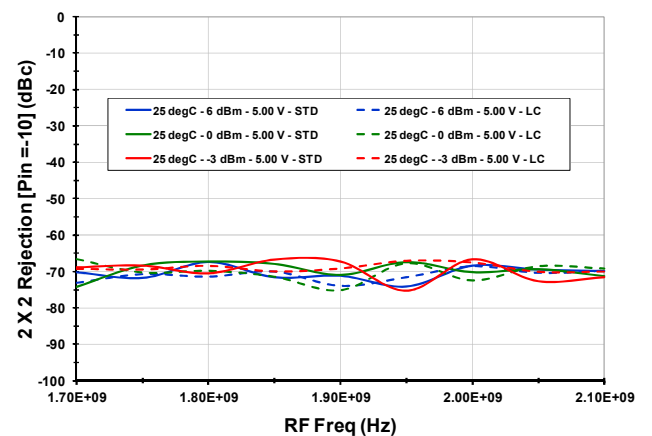

RF to IF Dual Downconverting Mixer

1400 - 2200 MHz F1152NBGI

TYPICAL OPERATING CONDITIONS (-3-)

I_{CC} vs. T_{CASE}

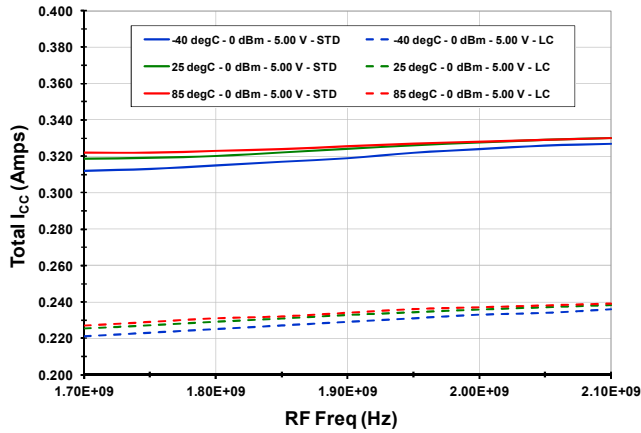

I_{CC} vs. V_{CC}

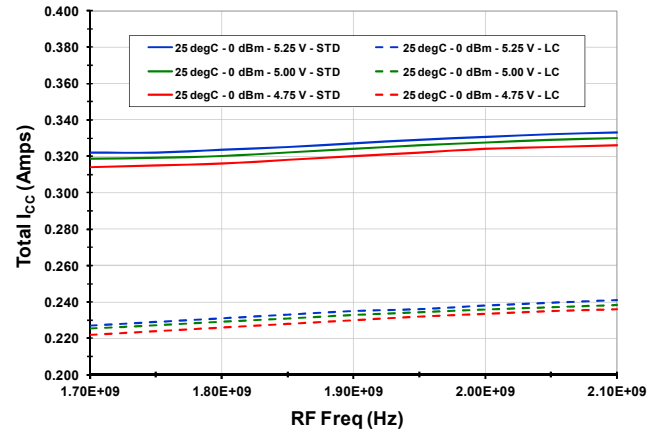

I_{CC} vs. LO Level

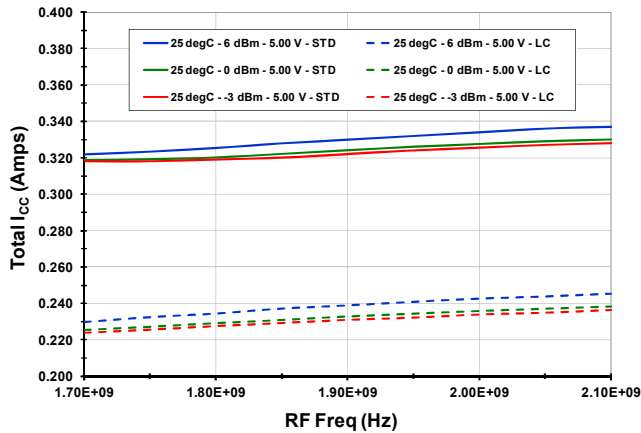

LO-IF Leakage vs. T_{CASE}

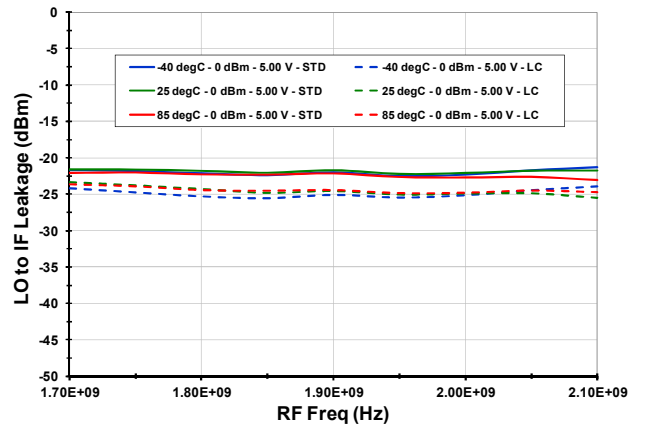

LO-IF Leakage vs. V_{CC}

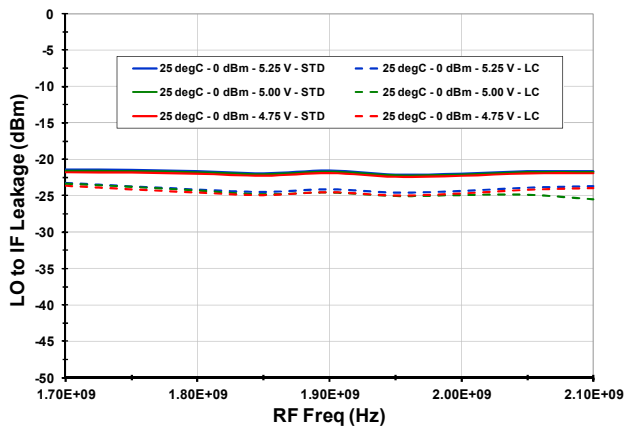

LO-IF Leakage vs. LO Level

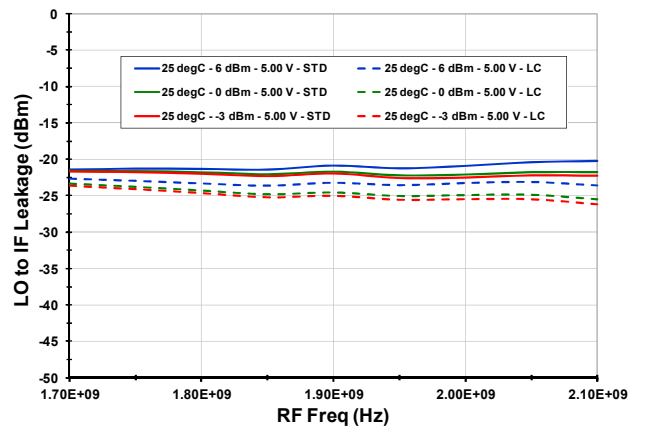

RF to IF Dual Downconverting Mixer

1400 - 2200 MHz F1152NBGI

TYPICAL OPERATING CONDITIONS (-4-)

RF-IF Leakage vs. T_{CASE}

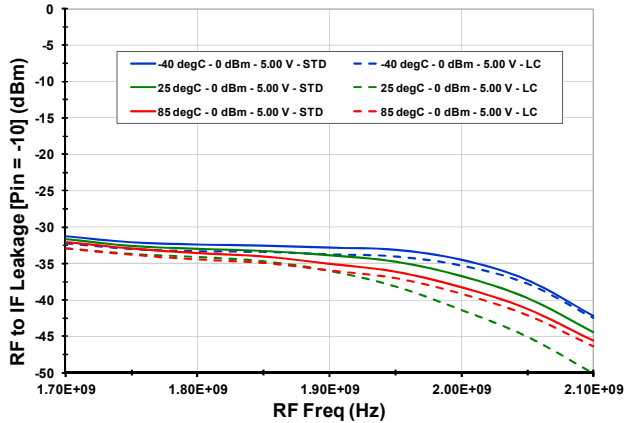

RF-IF Leakage vs. V_{CC}

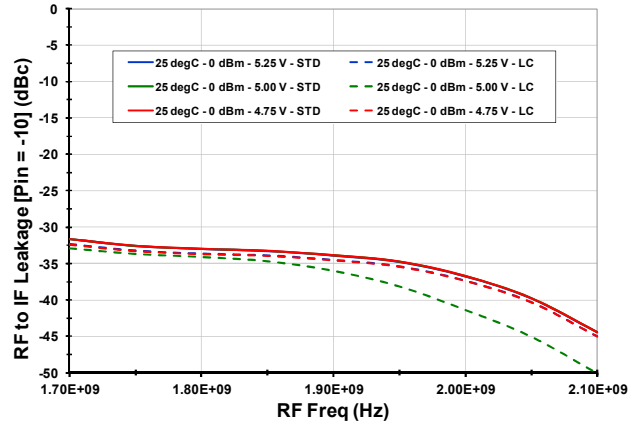

RF-IF Leakage vs. LO Level

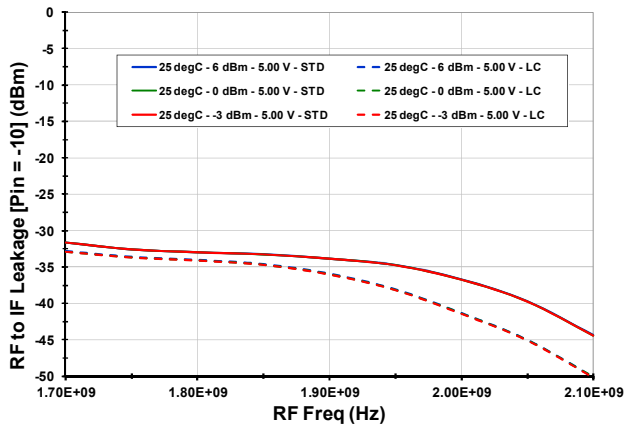

3RF X 3LO Rejection vs. LO Level

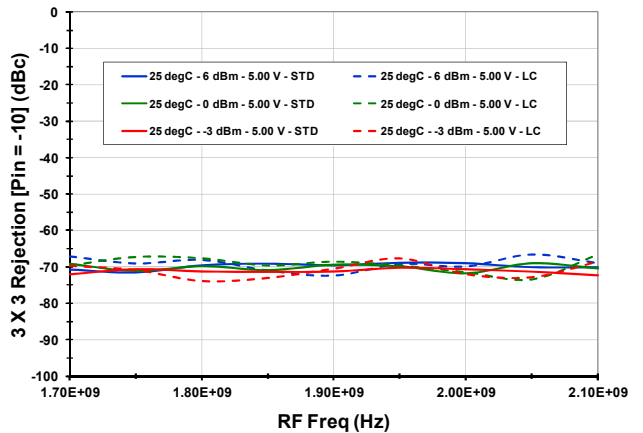

IP_{3O} Distribution ($F_{RF} = 1850\text{MHz}$, LC mode, $N = 3168$)

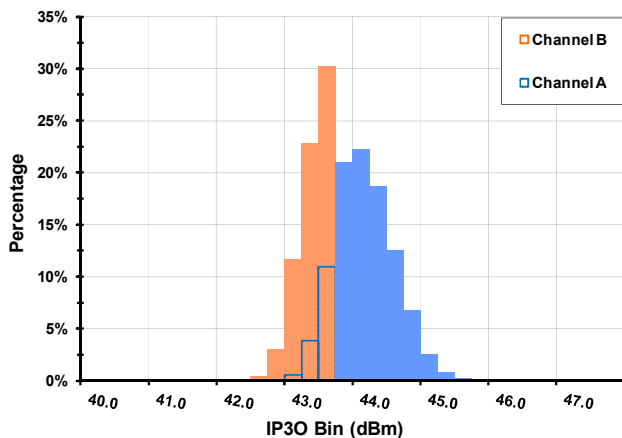

Gain Distribution ($F_{RF} = 1710\text{MHz}$, STD mode, $N = 3168$)

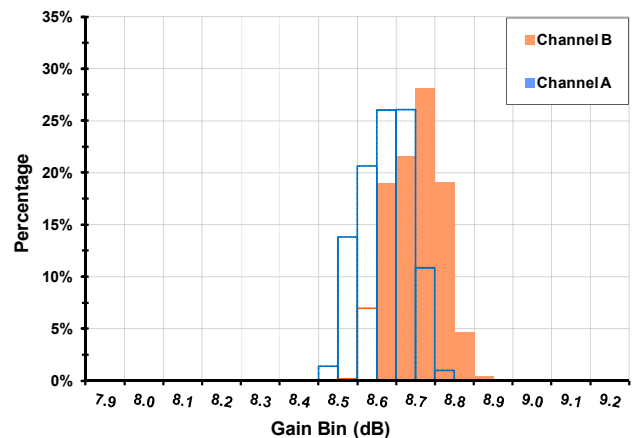

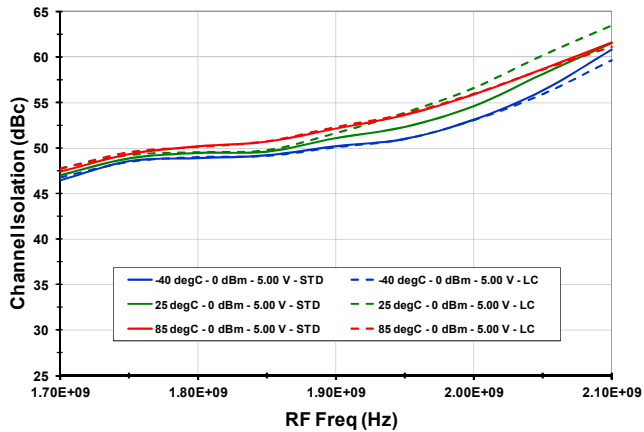
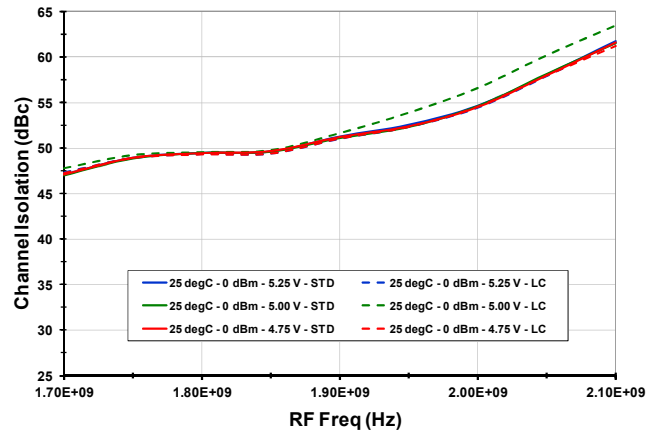
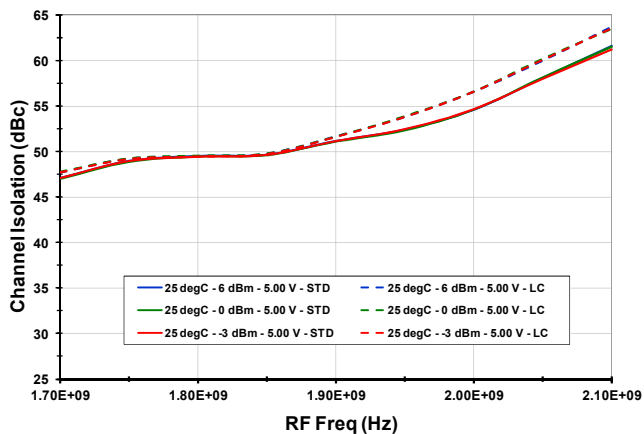
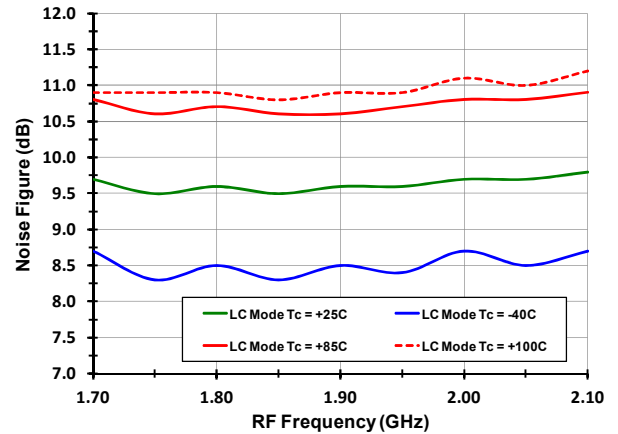
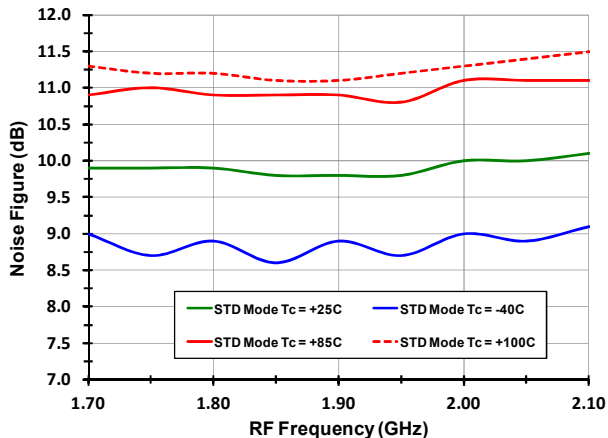
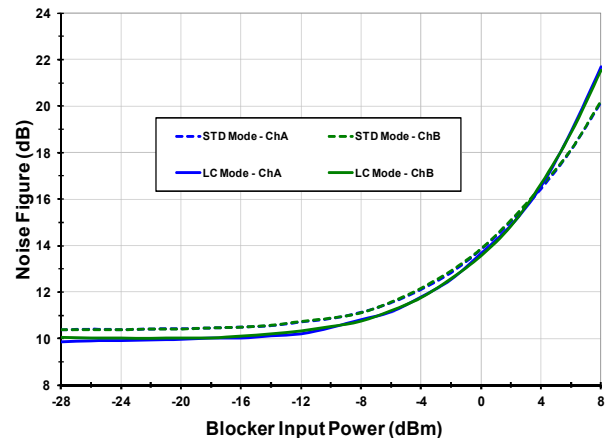
RF to IF Dual Downconverting Mixer
1400 - 2200 MHz F1152NBGI
TYPICAL OPERATING CONDITIONS (-5-)
Channel Isolation vs. T_{CASE}

Channel Isolation vs. V_{CC}

Channel Isolation vs. LO Level

Noise Figure vs. T_{CASE} (LC Mode)

Noise Figure vs. T_{CASE} (STD Mode)

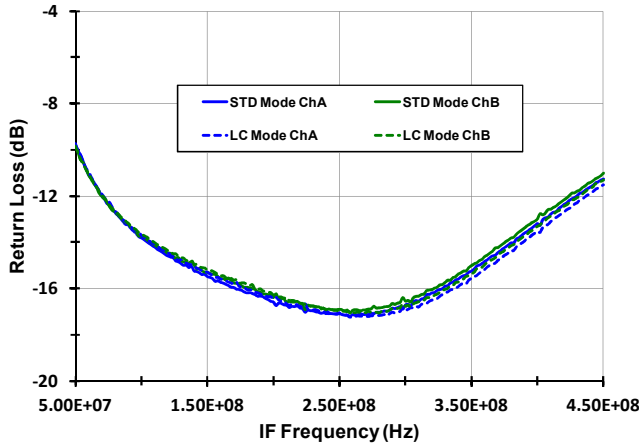
NF vs. Blocker (RF = 1850 MHz, IF = 250 MHz, $T_A = 25C$)

RF to IF Dual Downconverting Mixer

1400 - 2200 MHz F1152NBGI

TYPICAL OPERATING CONDITIONS (-6-)

EVkit IF Port Match ($T_A = 25C$)



Alt. LO port (pin27) vs. Main LO port (pin19)

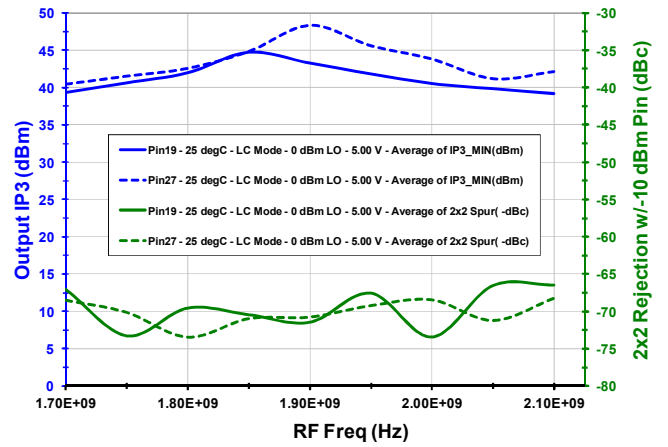

Settling Time (STBY -> V_{IL})

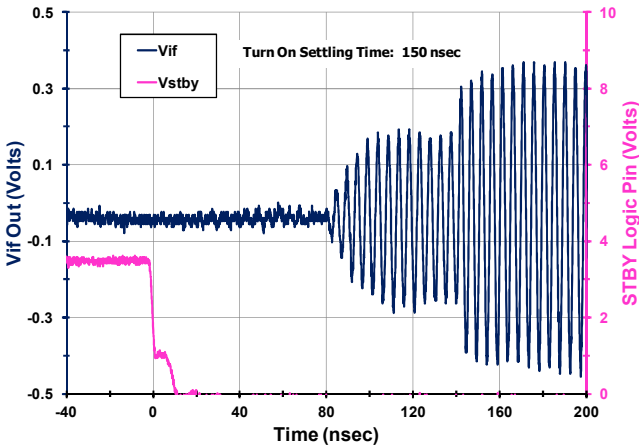

Settling Time (STBY -> V_{IH})

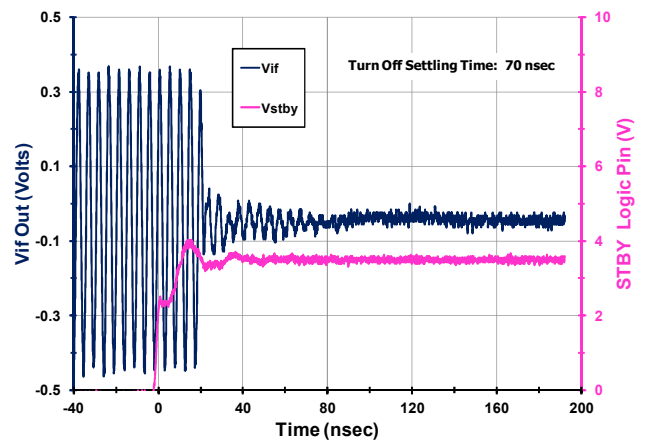

EVKit LO Port Match ($T_A = 25C$, $P_{MEAS} = 0$ dBm)

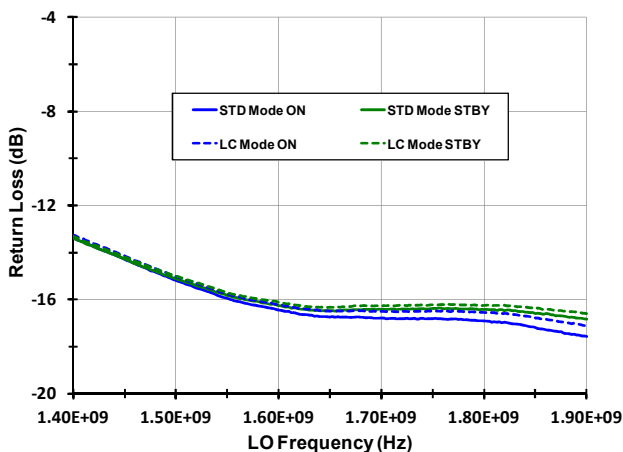

EVkit RF Port Match ($T_A = 25C$)

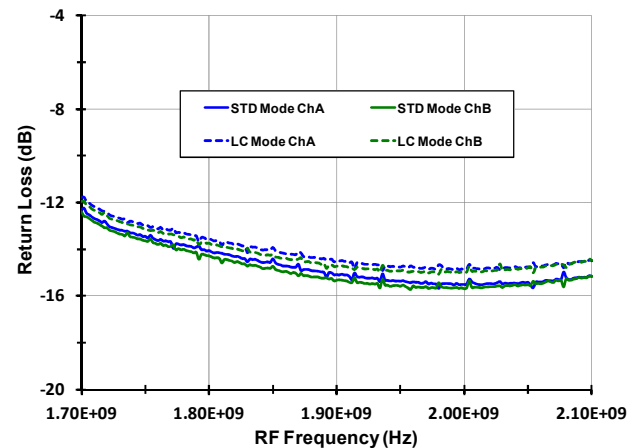

RF to IF Dual Downconverting Mixer

1400 - 2200 MHz F1152NBGI

TYPICAL OPERATING CONDITIONS (-7-)

IP_{3O} vs. Tone Δf (T_A = 25C, Freq = 1850 MHz)

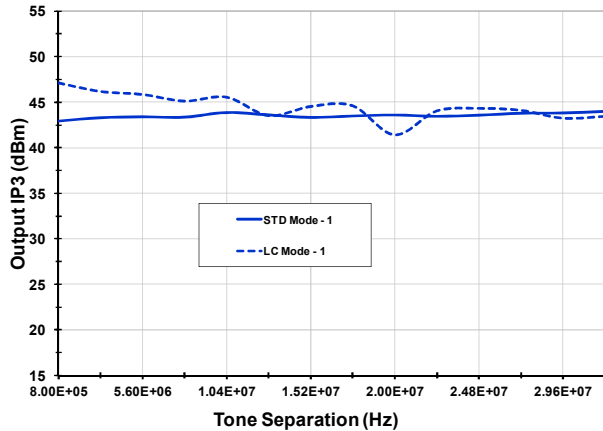

IP_{3O} vs. P_{IN} (T_A = 25C, Freq = 1850 MHz)

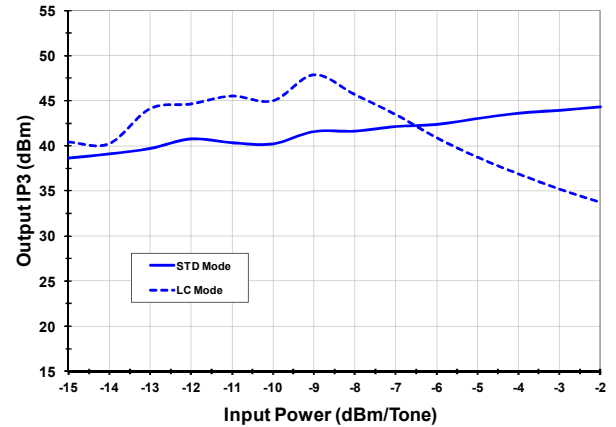

Hi-side Injection Gain (Bands 11, 21, 24 see p. 20)

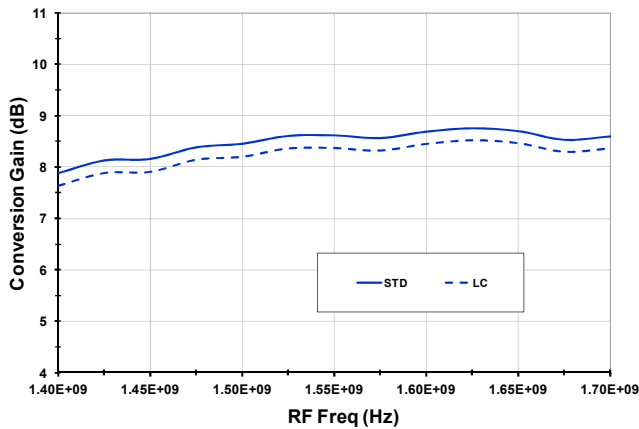

Hi-side Injection Output IP3 (Bands 11, 21, 24)

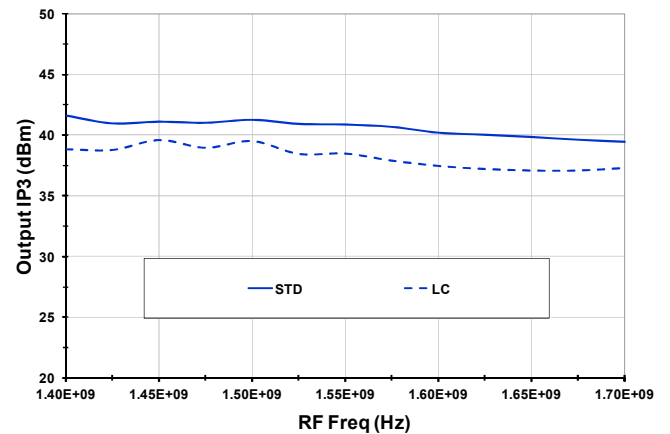

Hi-side Injection P1dB_I (Bands 11, 21, 24)

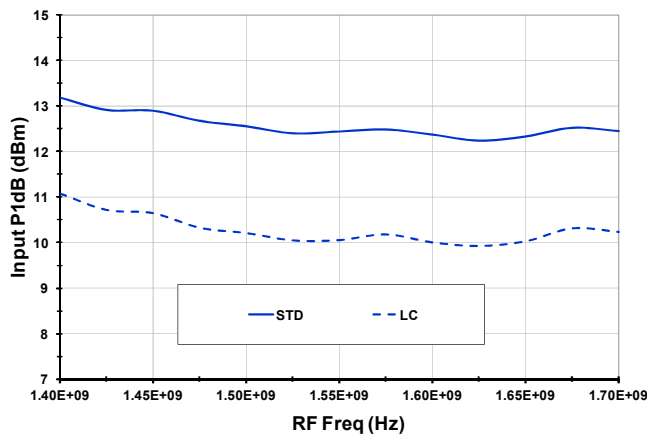

Hi-side Injection 2x2 (Bands 11, 21, 24)

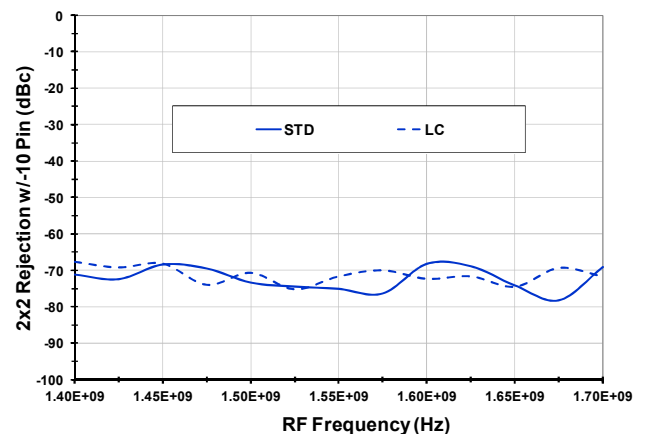

RF to IF Dual Downconverting Mixer

1400 - 2200 MHz F1152NBGI

TYPICAL OPERATING CONDITIONS (-8-)

Hi-side Injection LO to IF (Bands 11, 21, 24)

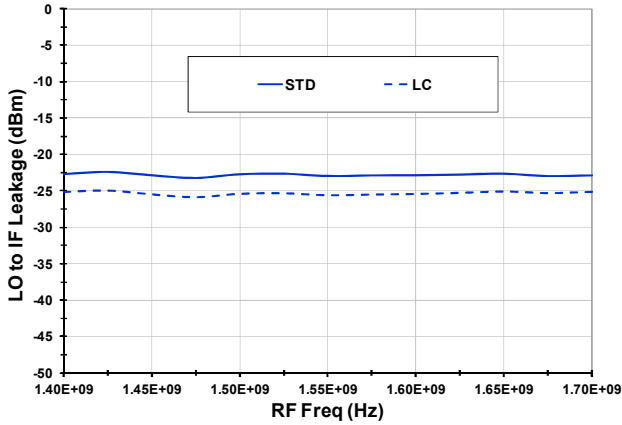

Hi-side Injection RF to IF (Bands 11, 21, 24)

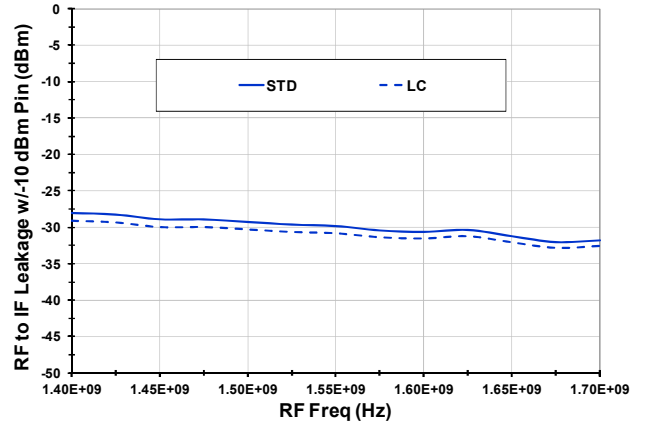

Hi-side Injection 3x3 (Bands 11, 21, 24)

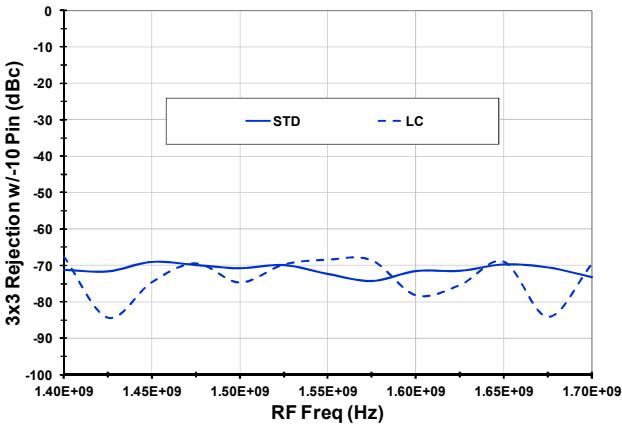

Hi-side Injection Channel Iso (Bands 11, 21, 24)

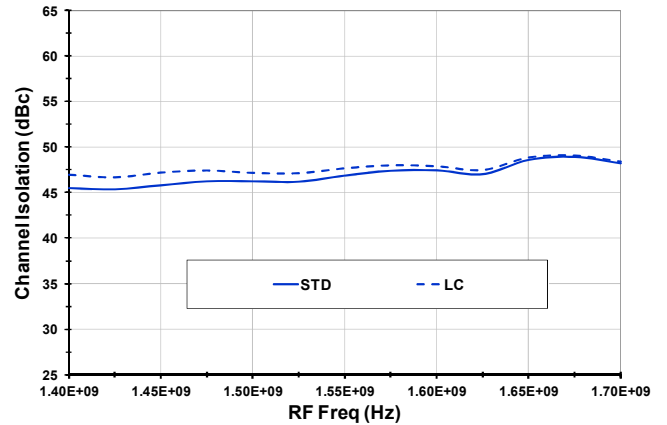

Hi-side Injection I_{CC} (Bands 11, 21, 24)

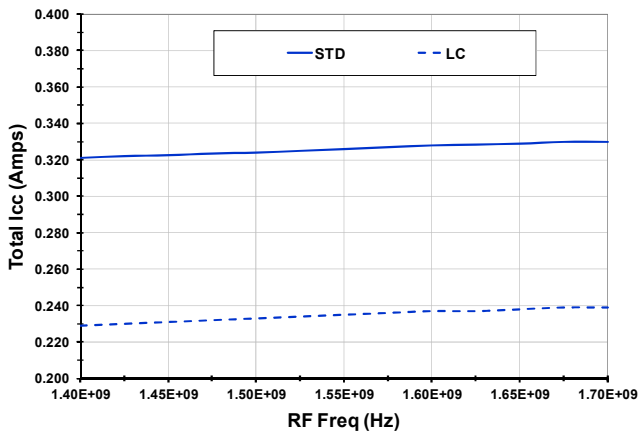

Hi-side Injection RF Port Matches (see p. 22)

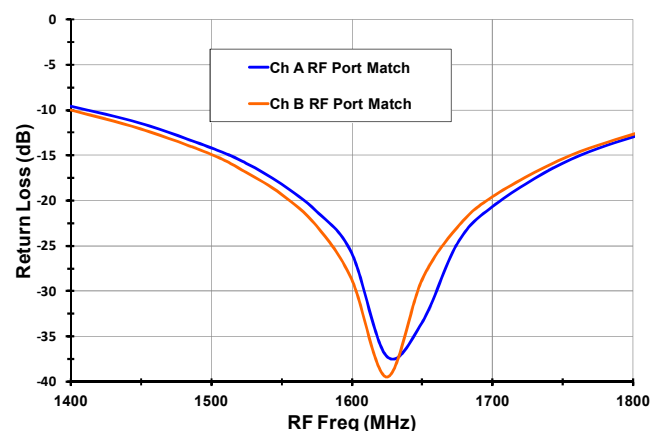

HIGH TEMPERATURE OPERATING CONDITIONS (-1-)

Gain at Normal and High (+100C) Temps

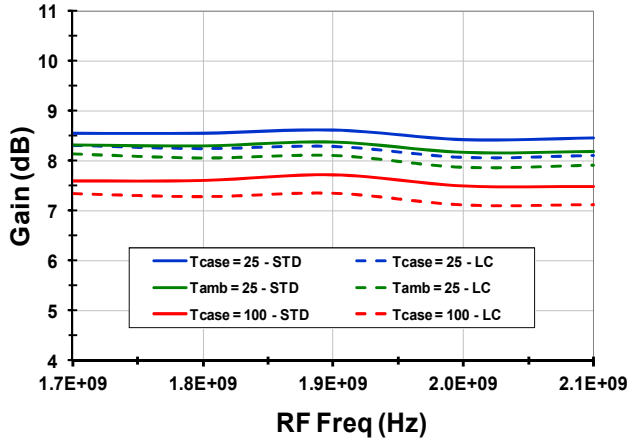

Output IP3 at Normal and High (+100C) Temps

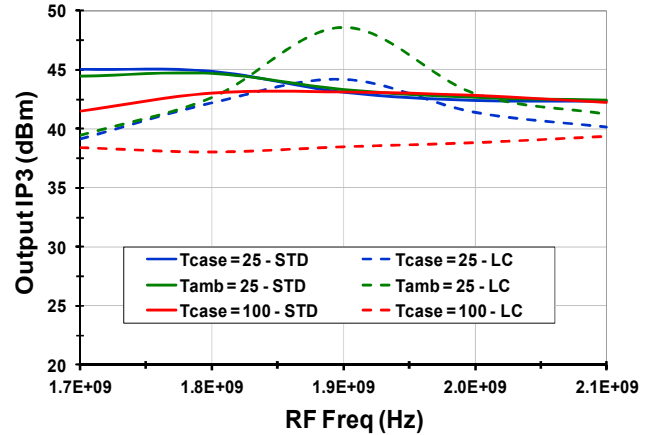

Input P1dB at Normal and High (+100C) Temps

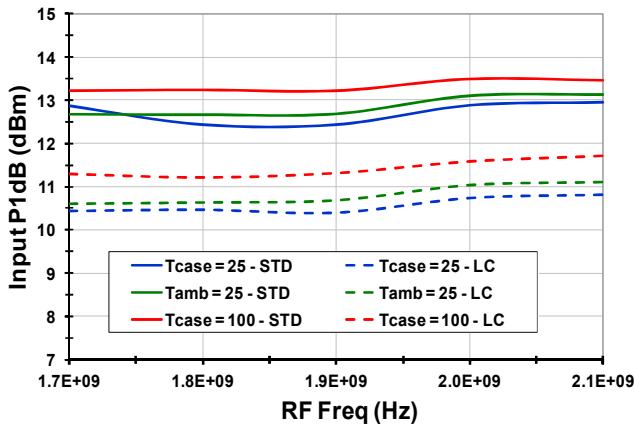

2RF X 2LO at Normal and High (+100C) Temps

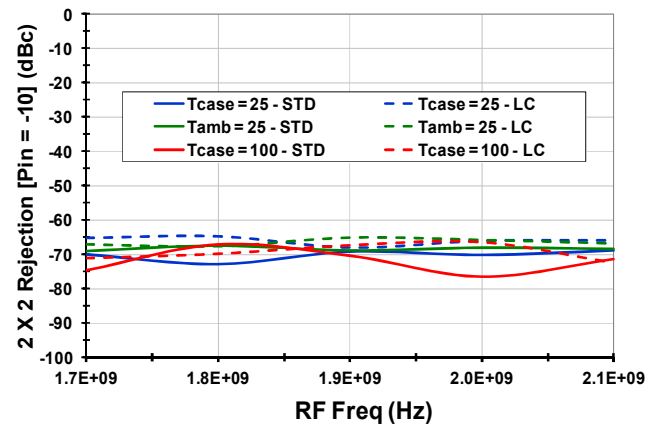

3RF X 3LO at Normal and High (+100C) Temps

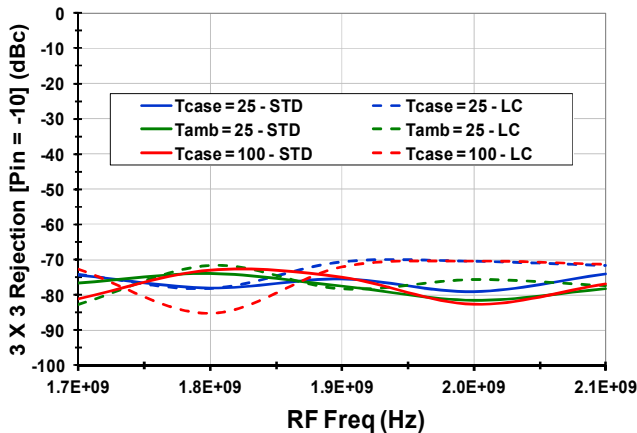

Output P1dB at Normal and High (+100C) Temps

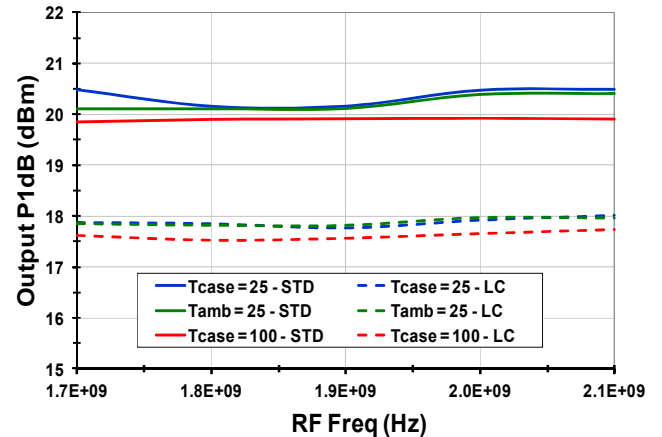

RF to IF Dual Downconverting Mixer

1400 - 2200 MHz F1152NBGI

PACKAGE DRAWING (6X6 QFN)

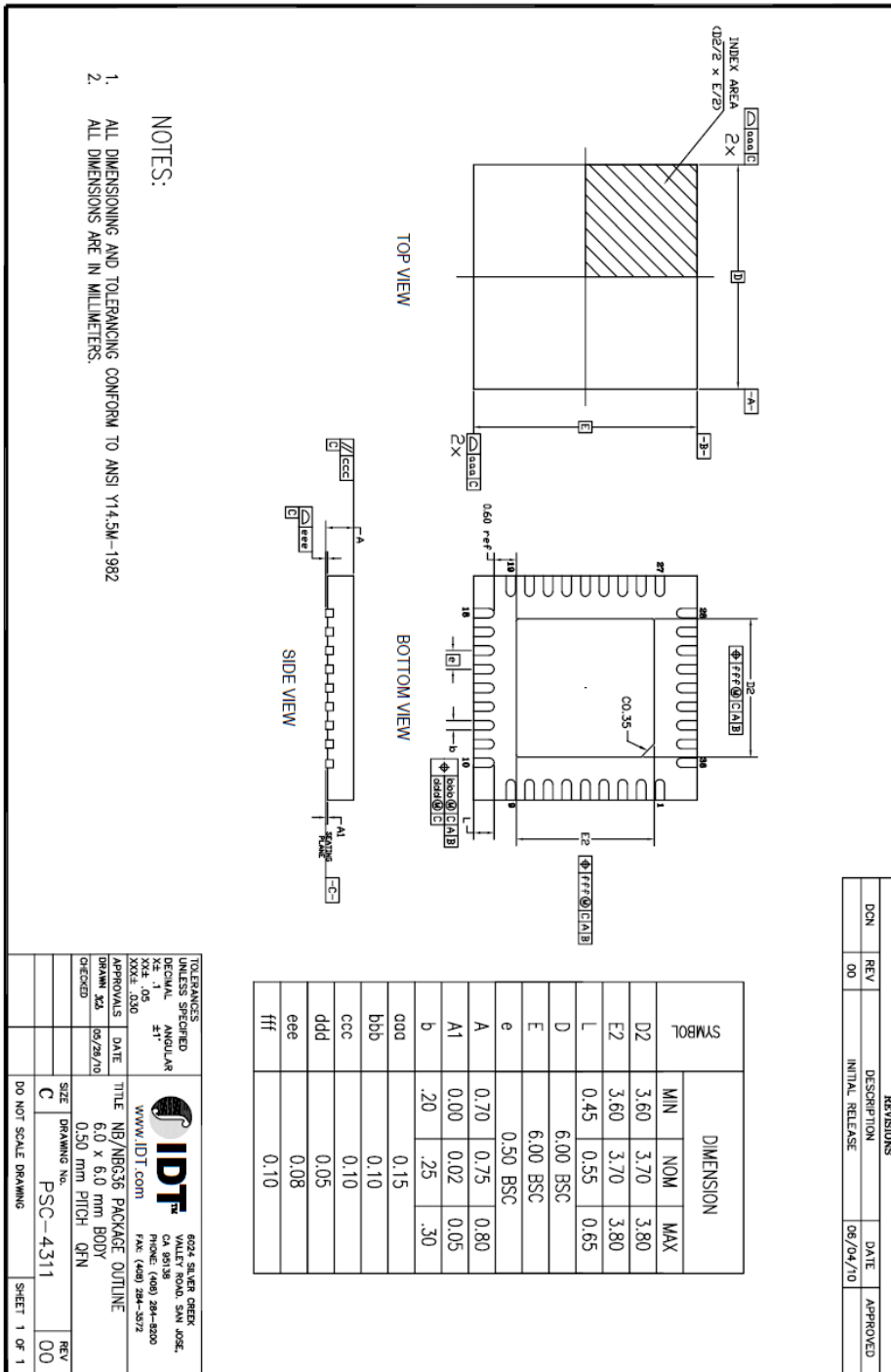

| REVISIONS | | | |
|-----------|-----|-----------------|----------|
| DCH | REV | DESCRIPTION | DATE |
| | 00 | INITIAL RELEASE | 08/04/10 |

| | |
|-----------------------------|------------------------|
| TOLERANCES UNLESS SPECIFIED | 6024 SILVER CREEK |
| DECIMAL | VALLEY ROAD, SAN JOSE, |
| ANGULAR | CA 95131 |
| XX ± .05 | WWW.IDT.COM |
| XX ± .1 | PHONE: (408) 284-8000 |
| XX ± .050 | FAX: (408) 284-5972 |
| APPROVALS | DATE |
| DRW: XAS | 02/25/10 |
| CHECKED | |
| TITLE | 6.0 x 6.0 mm BODY |
| | 0.50 mm PITCH QFN |
| SIZE | PSC-4311 |
| DO NOT SCALE DRAWING | |
| SHEET 1 OF 1 | REV 00 |

RF to IF Dual Downconverting Mixer

1400 - 2200 MHz F1152NBGI

PINOUTS

Black Text denotes recommended external connection

Red Text denotes internal Function or Connection

- DB GND = Downbonded to Paddle
- Internal NC = Pin not connected

Please Note!

- Only connect to one LO feed
- Choose Either Pin 19 or Pin 27
- Do not connect the unused LO pin to ensure good LO return loss

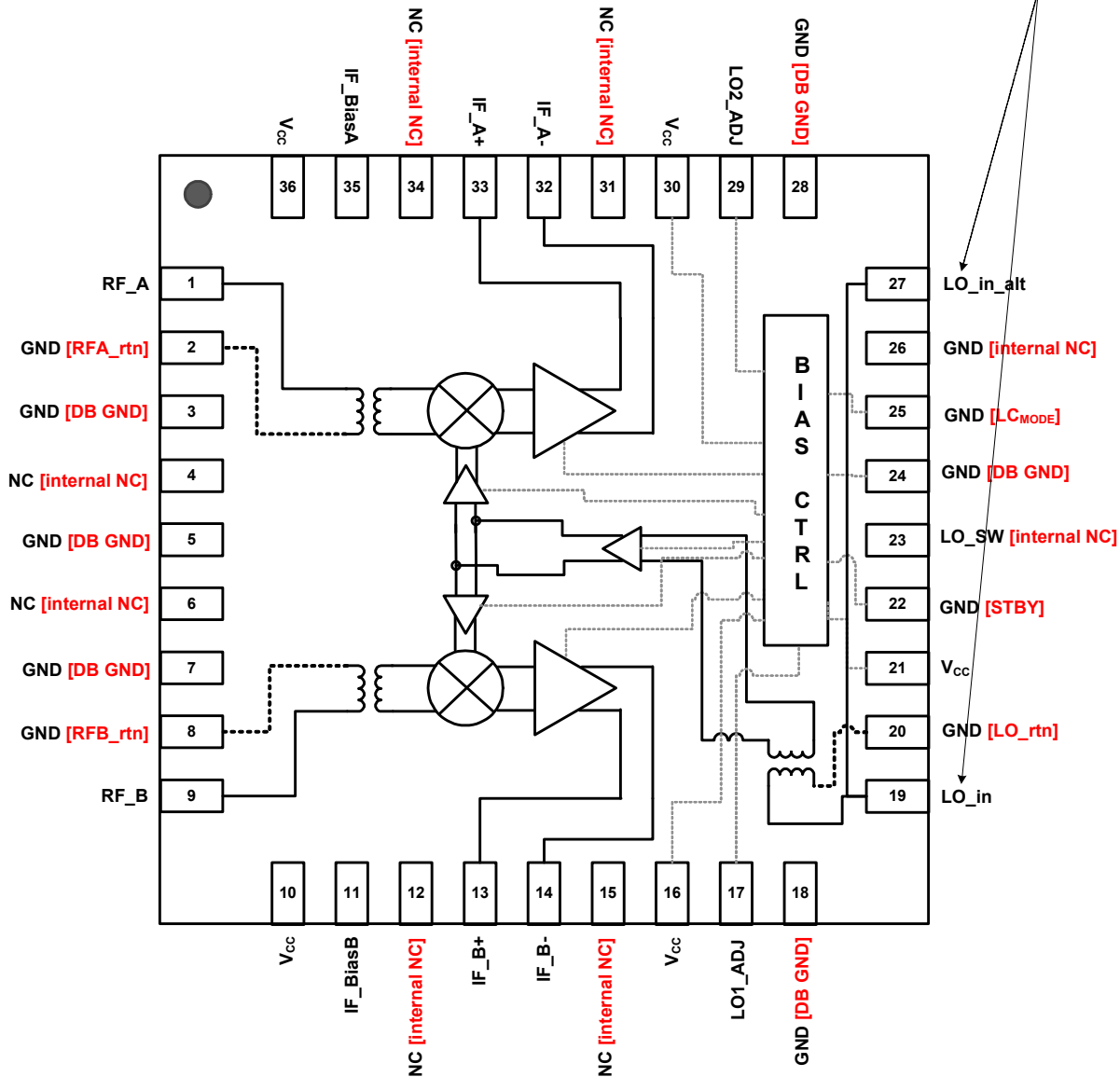

PIN DESCRIPTIONS

| Pin | Name | Function |
|---------------------------------|-----------------------------|--|
| 1 | RF_A | Main Channel RF Input. Internally matched to 50Ω. DO NOT apply DC to these pins |
| 2, 8, 20 | RF_Artn, RF_Brtn, LO_rtn | Transformer Ground Returns. Ground these pins. |
| 3, 5, 7, 18, 24, 28 | GND | Ground these pins. |
| 4, 6, 12, 15, 31, 23, 26, 34 | N.C. | No Connection. Not internally connected. OK to connect to Vcc. OK to connect to GND |
| 10, 16, 21, 30, 36 | VCC | Power Supply. Bypass to GND with capacitors shown in the Typical Application Circuit as close as possible to pin. |
| 9 | RF_B | Diversity Channel RF Input. Internally matched to 50Ω |
| 11 | IF_BiasB | Connect the specified resistor from this pin to ground to set the bias for the Diversity IF amplifier. This is NOT a current set resistor |
| 13, 14 | IFB+, IFB- | Diversity Mixer Differential IF Output. Connect pullup inductors from each of these pins to VCC (see the Typical Application Circuit). |
| 17 | LO1_ADJ | Connect the specified resistor for either Standard or LC mode from this pin to ground to set the LO common buffer Icc |
| 19, 27 | LO_in LO_in_alt | Local Oscillator Input. Connect the LO to this port through the recommended coupling capacitor. Note that you can only drive one LO port at a time. Remove the series capacitor from the unused port. |
| 25 | LC_MODE | Low Current Mode. Set this pin to low or ground for LC mode. Set to high or No-Connect for Standard mode. There is an internal pull-up resistor. |
| 22 | STBY | STBY Mode. Pull this pin high for Standby mode (~20 mA). Pull low or Ground for normal Operation |
| 29 | LO2_ADJ | Connect the specified resistor for either Standard or LC mode from this pin to ground to set the LO drive buffers Icc |
| 32, 33 | IFA-, IFA+ | Main Mixer Differential IF Output. Connect pullup inductors from each of these pins to VCC (see the Typical Application Circuit). |
| 35 | IF_BiasA | Connect the specified resistor from this pin to ground to set the bias for the Main IF amplifier. This is NOT a current set resistor |
| | — EP | Exposed Pad. Internally connected to GND. Solder this exposed pad to a PCB pad that uses multiple ground vias to provide heat transfer out of the device into the PCB ground planes. These multiple via grounds are also required to achieve the noted RF performance. |
| | | |

EVKIT SCHEMATIC

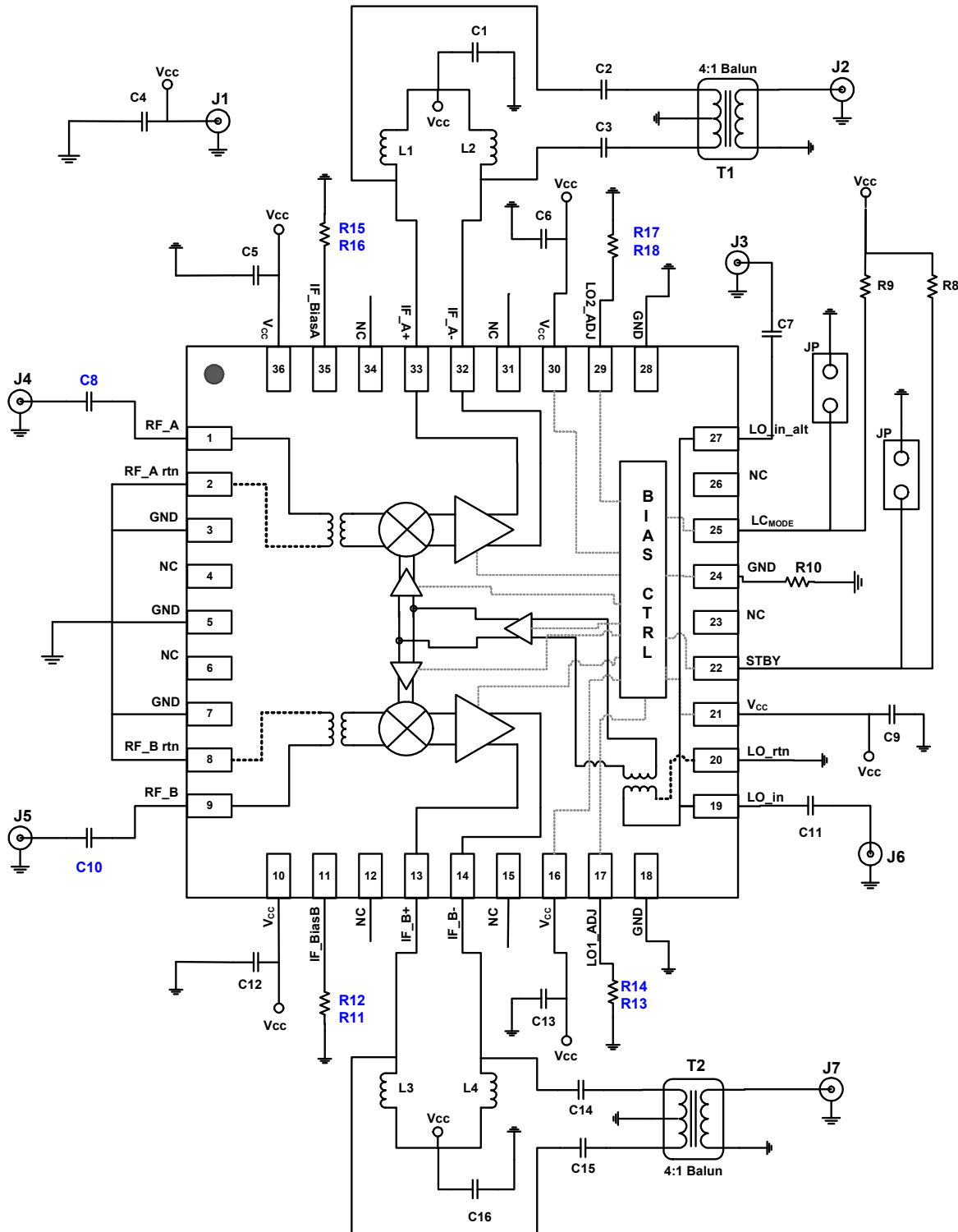

EVKIT PICTURE/LAYOUT/OPERATION

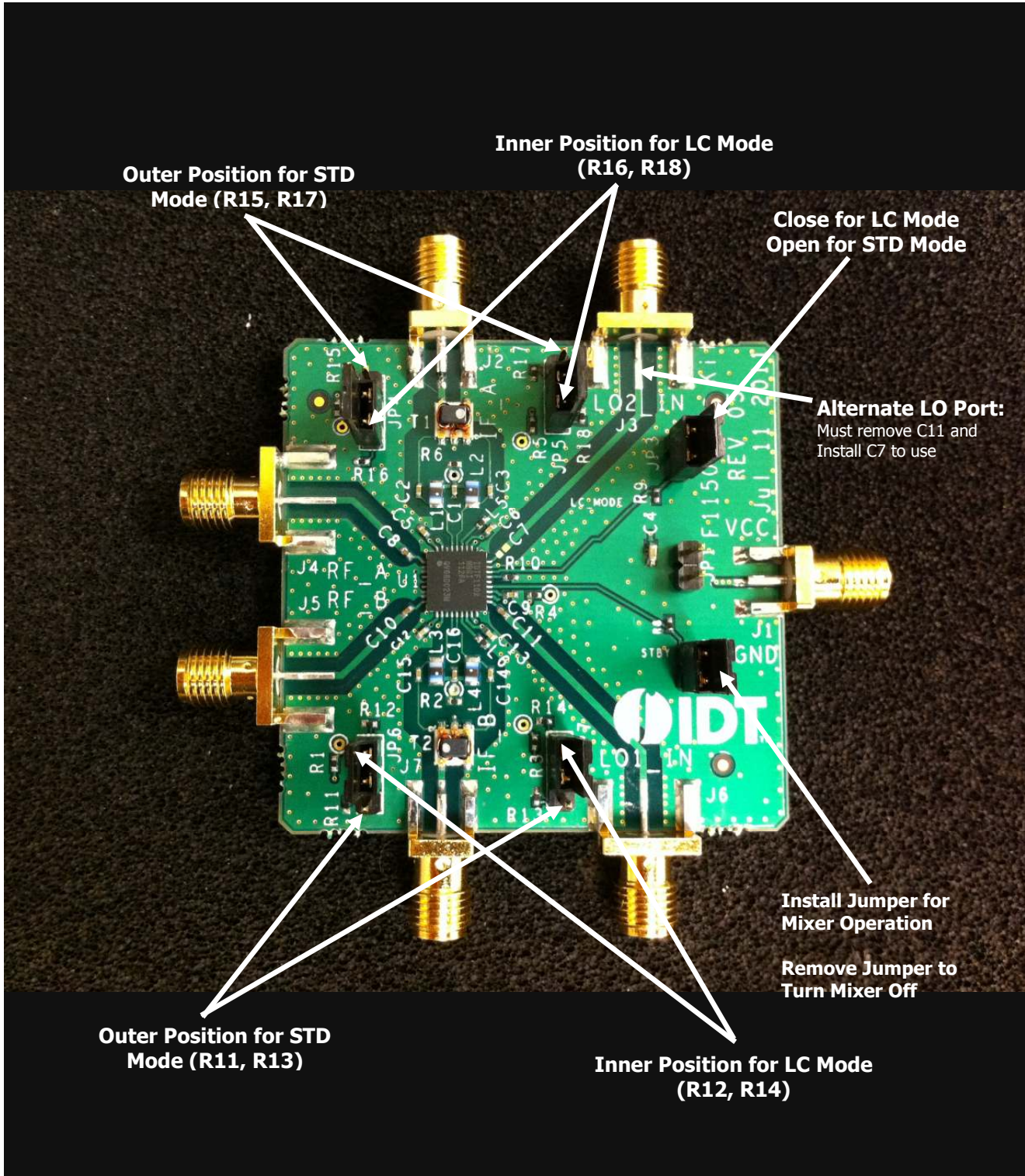

RF to IF Dual Downconverting Mixer
1400 - 2200 MHz F1152NBGI
EVKIT BOM

For Standard Mode, Open the LC_{MODE} jumper in conjunction with positioning the 4 dual jumpers to select the resistors in **red**.

For Low Current Mode close the LC_{MODE} jumper in conjunction with positioning the 4 dual jumpers to select the resistors in **blue**.

F1152 BOM

| Item # | Value | Size | Desc | Mfr. Part # | Mfr. | Part Reference | Qty |
|--------|---------------------------|--------|--|--------------------|-----------------|-------------------|-----|
| 1 | 10nF | 0402 | CAP CER 10000PF 16V 10% X7R 0402 | GRM155R71C103KA01D | MURATA | C1,5,6,9,12,13,16 | 7 |
| 2 | 1000pF | 0402 | CAP CER 1000PF 50V COG 0402 | GRM1555C1H102JA01D | MURATA | C2,3,14,15 | 4 |
| 3 | 39pF | 0402 | CAP CER 39PF 50V 5% COG 0402 | GRM1555C1H390JZ010 | MURATA | C8,10,11 | 3 |
| 4 | 6pF | 0402 | Note: C7 and C11 cannot be installed together. C7 for Pin27 LO feed. C11 for Pin19 LO feed. | | | C7 | 1 |
| 5 | 10uF | 0603 | CAP CER 10UF 6.3V X5R 0603 | GRM188R60J106ME47D | MURATA | C4 | 1 |
| 6 | Header 2 Pin | TH 2 | CONN HEADER VERT SGL 2POS GOLD | 961102-6404-AR | 3M | JP1,2,3 | 3 |
| 7 | Header 3 Pin | TH 3 | CONN HEADER VERT SGL 3POS GOLD | 961103-6404-AR | 3M | JP4,5,6,7 | 4 |
| 8 | SMA_END_LAUNCH | 062 | SMA_END_LAUNCH | 142-0711-821 | Emerson Johnson | J1,2,3,4,5,6,7 | 7 |
| 9 | 270nH | 0805 | 0805CS (2012) Ceramic Chip Inductor | 0805CS-271XJLB | COILCRAFT | L1,2,3,4 | 4 |
| 10 | 27 | 0402 | RES 27 OHM 1/10W 1% 0402 SMD | ERJ-2RKF27R0X | Panasonic | R11,15 | 2 |
| 11 | 63 | 0402 | RES 63 OHM 1/10W 1% 0402 SMD | ERJ-2RKF63R0X | Panasonic | R12,16 | 2 |
| 12 | 220 | 0402 | RES 220 OHM 1/10W 1% 0402 SMD | ERJ-2RKF2200X | Panasonic | R13 | 1 |
| 13 | 240 | 0402 | RES 240 OHM 1/10W 1% 0402 SMD | ERJ-2RKF2400X | Panasonic | R14 | 1 |
| 14 | 2.15K | 0402 | RES 2.15K OHM 1/10W 1% 0402 SMD | | Panasonic | R18 | 1 |
| 15 | 1.3K | 0402 | RES 1.3K OHM 1/10W 1% 0402 SMD | ERJ-2RKF1311X | Panasonic | R17 | 1 |
| 16 | 47K | 0402 | RES 47.0K OHM 1/16W 1% 0402 SMD | RC0402FR-0747KL | Yageo | R8,9 | 2 |
| 17 | 0 | 0402 | RES 0.0 OHM 1/10W 0402 SMD | ERJ-2GE0R00X | Panasonic | R1,2,3,4,5,6,7,10 | 10 |
| 18 | 4:1 Balun | SM-22 | 4:1 Center Tap Balun | TC4-1TG2+ | Mini Circuits | T1,2 | 2 |
| 19 | F1152 (Date Code >= 1201) | QFN-36 | Diversity Downconverter | IDTF1152NBGI | IDT | U1 | 1 |
| 20 | PCB | | | F1152 EVKit Rev5 | | | 1 |

RF Matching for High Side Injection (1400 – 1700 MHz Bands 11, 21, 24)

See Graphs on Pages 12, 13

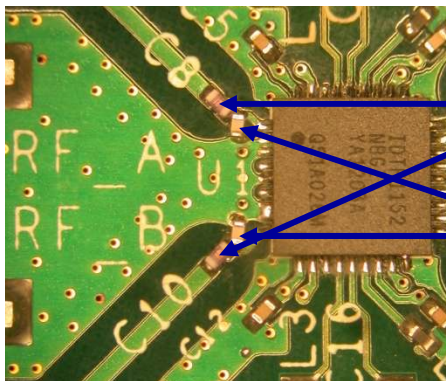

Change C8 and C10 to 4.3 nH

Scrape Trace Resist and add shunt 0.5 pF

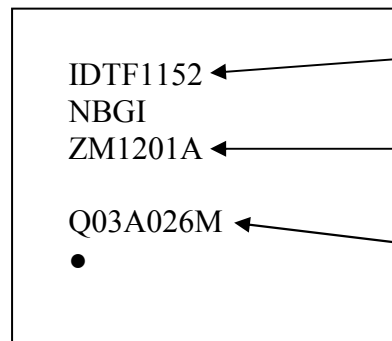
TOPMARKINGS

Part Number

 Date Code: [xxYYWWx]
(Work Week 1 of 2012)

Lot Code

NOTE: Production Devices are DateCode 1201 or later.

IMPORTANT NOTICE AND DISCLAIMER

RENESAS ELECTRONICS CORPORATION AND ITS SUBSIDIARIES (“RENESAS”) PROVIDES TECHNICAL SPECIFICATIONS AND RELIABILITY DATA (INCLUDING DATASHEETS), DESIGN RESOURCES (INCLUDING REFERENCE DESIGNS), APPLICATION OR OTHER DESIGN ADVICE, WEB TOOLS, SAFETY INFORMATION, AND OTHER RESOURCES “AS IS” AND WITH ALL FAULTS, AND DISCLAIMS ALL WARRANTIES, EXPRESS OR IMPLIED, INCLUDING, WITHOUT LIMITATION, ANY IMPLIED WARRANTIES OF MERCHANTABILITY, FITNESS FOR A PARTICULAR PURPOSE, OR NON-INFRINGEMENT OF THIRD PARTY INTELLECTUAL PROPERTY RIGHTS.

These resources are intended for developers skilled in the art designing with Renesas products. You are solely responsible for (1) selecting the appropriate products for your application, (2) designing, validating, and testing your application, and (3) ensuring your application meets applicable standards, and any other safety, security, or other requirements. These resources are subject to change without notice. Renesas grants you permission to use these resources only for development of an application that uses Renesas products. Other reproduction or use of these resources is strictly prohibited. No license is granted to any other Renesas intellectual property or to any third party intellectual property. Renesas disclaims responsibility for, and you will fully indemnify Renesas and its representatives against, any claims, damages, costs, losses, or liabilities arising out of your use of these resources. Renesas' products are provided only subject to Renesas' Terms and Conditions of Sale or other applicable terms agreed to in writing. No use of any Renesas resources expands or otherwise alters any applicable warranties or warranty disclaimers for these products.

(Disclaimer Rev.1.0 Mar 2020)

Corporate Headquarters

TOYOSU FORESIA, 3-2-24 Toyosu,
Koto-ku, Tokyo 135-0061, Japan
www.renesas.com

Contact Information

For further information on a product, technology, the most up-to-date version of a document, or your nearest sales office, please visit:
www.renesas.com/contact/

Trademarks

Renesas and the Renesas logo are trademarks of Renesas Electronics Corporation. All trademarks and registered trademarks are the property of their respective owners.