



Connectors > Automotive Connectors > Automotive Connector Accessories > Automotive Connector EMC Shielding



Connector Shielding Accessory Type: **Ferrule**

Primary Product Material: **Copper Alloy**

Sealable: **No**

Features

Product Type Features

Connector Shielding Accessory Type	Ferrule
Sealable	No

Body Features

Primary Product Material	Copper Alloy
--------------------------	--------------

Product Compliance

[For compliance documentation, visit the product page on TE.com>](#)

EU RoHS Directive 2011/65/EU	Compliant
EU ELV Directive 2000/53/EC	Compliant
China RoHS 2 Directive MIIT Order No 32, 2016	No Restricted Materials Above Threshold
EU REACH Regulation (EC) No. 1907/2006	Current ECHA Candidate List: JUNE 2023 (235) Candidate List Declared Against: JUNE 2023 (235) Does not contain REACH SVHC
Halogen Content	Low Halogen - Br, Cl, F, I < 900 ppm per homogenous material. Also BFR/CFR/PVC Free
Solder Process Capability	Not reviewed for solder process capability

Product Compliance Disclaimer

This information is provided based on reasonable inquiry of our suppliers and represents our current actual knowledge based on the information they provided. This information is subject to change. The part numbers that TE has identified as EU RoHS compliant have a maximum concentration of 0.1% by weight in homogenous materials for lead, hexavalent chromium, mercury, PBB, PBDE, DBP, BBP, DEHP, DIBP, and 0.01% for cadmium, or qualify for an exemption to these

limits as defined in the Annexes of Directive 2011/65/EU (RoHS2). Finished electrical and electronic equipment products will be CE marked as required by Directive 2011/65/EU. Components may not be CE marked. Additionally, the part numbers that TE has identified as EU ELV compliant have a maximum concentration of 0.1% by weight in homogenous materials for lead, hexavalent chromium, and mercury, and 0.01% for cadmium, or qualify for an exemption to these limits as defined in the Annexes of Directive 2000/53/EC (ELV). Regarding the REACH Regulation, the information TE provides on SVHC in articles for this part number is based on the latest European Chemicals Agency (ECHA) 'Guidance on requirements for substances in articles' posted at this URL: <https://echa.europa.eu/guidance-documents/guidance-on-reach>

Compatible Parts



TE Part # 4-2103015-5
PLUG SUBASSY, E, HVA280-2PHM F



TE Part # 4-2103015-2
PLUG SUBASSY, B, HVA280-2PHM F



TE Part # 4-2103015-4
PLUG SUBASSY, D, HVA280-2PHM F



TE Part # 4-2103015-1
PLUG SUBASSY, A, HVA280-2PHM F



TE Part # 1-1587715-0
Plug Subassy, FVMQ, Key B, HVA280-3PM



TE Part # 2103534-1
PLUG SUBASSY, A, HVA280



TE Part # 2103534-2
PLUG SUBASSY, B, HVA280



TE Part # 2103534-4
PLUG SUBASSY, D, HVA280



TE Part # 2103534-5
PLUG SUBASSY, E, HVA280



TE Part # 2103534-6
PLUG SUBASSY, F, HVA280

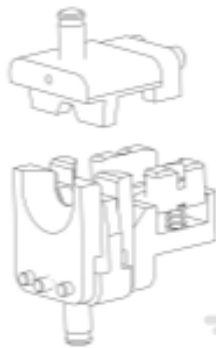

TE Part # 2234130-1
DIE SET HVA280-2P/3P F



TE Part # 4-2103015-6
PLUG SUBASSY, F, HVA280-2PHM F



TE Part # 7-2234130-7
CRIMP TOOLING KIT



TE Part # 9-2234130-1
APPLIC HVA280-2P/3P F



TE Part # 1587715-2
PLUG SUBASSY, NO HVIL, KEY B, HVA280-3PM



TE Part # 1587715-4
PLUG SUBASSY, NO HVIL, KEY D, HVA280-3PM



TE Part # 1587715-9
Plug Subassy, FVMO, Key A, HVA280-3PM

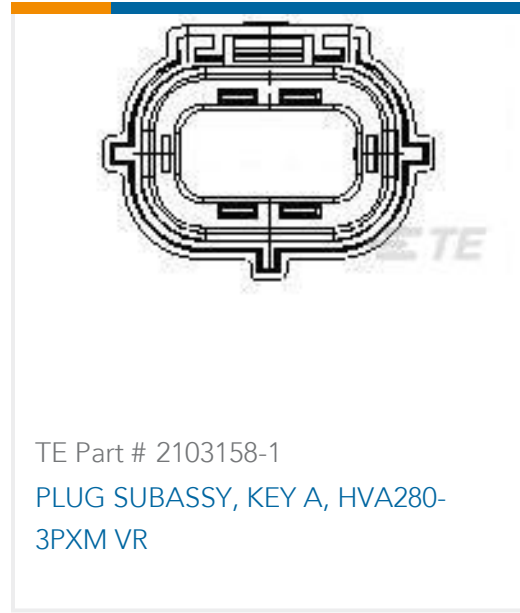

TE Part # 2103158-1
PLUG SUBASSY, KEY A, HVA280-3PXM VR

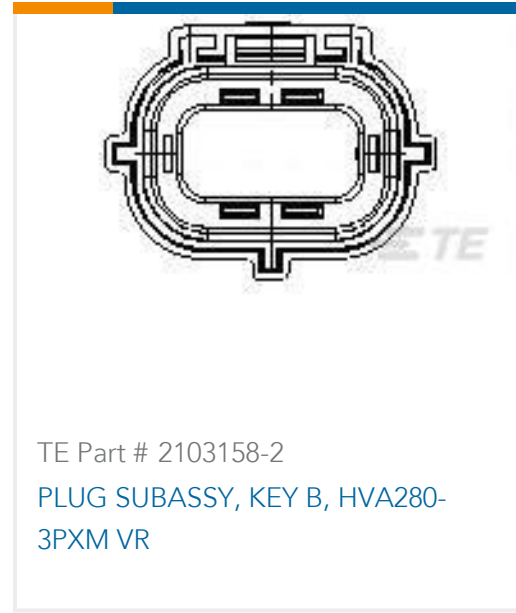

TE Part # 2103158-2
PLUG SUBASSY, KEY B, HVA280-3PXM VR



TE Part # 2103158-4
PLUG SUBASSY, KEY D, HVA280-3PXM VR

Also in the Series | HVA 280



Automotive Connector Caps & Covers (5)

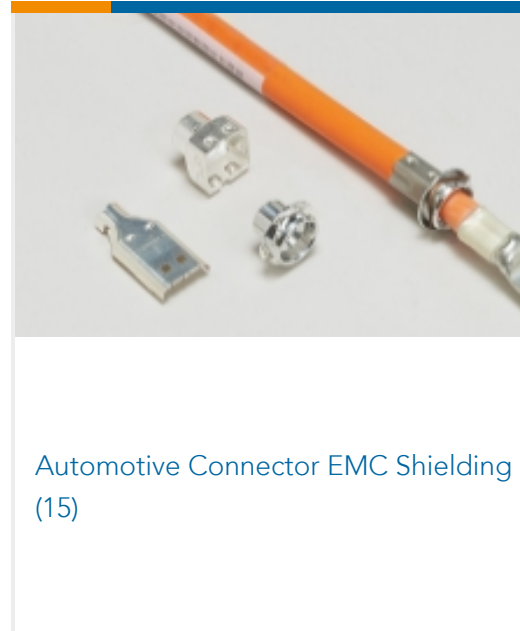

Automotive Connector EMC Shielding (15)

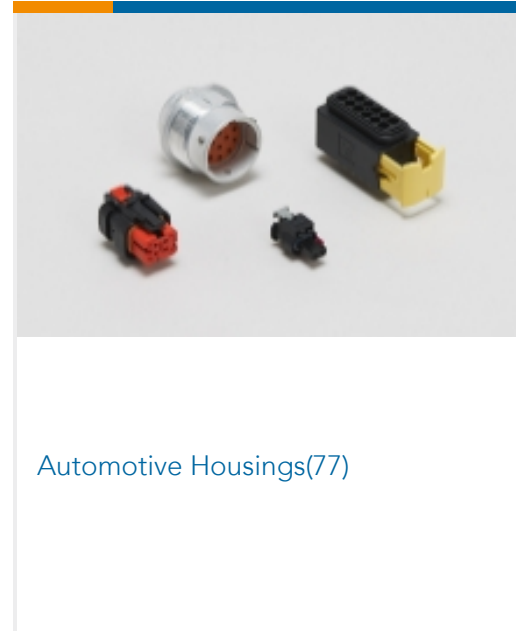

Automotive Housings(77)

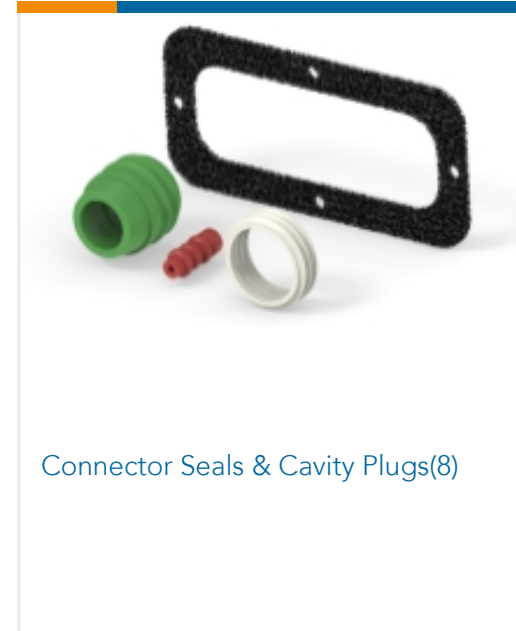

Connector Seals & Cavity Plugs(8)



Electric, Hybrid & Fuel Cell Cable Assemblies(6)



High Voltage Wire Processing Equipment(7)

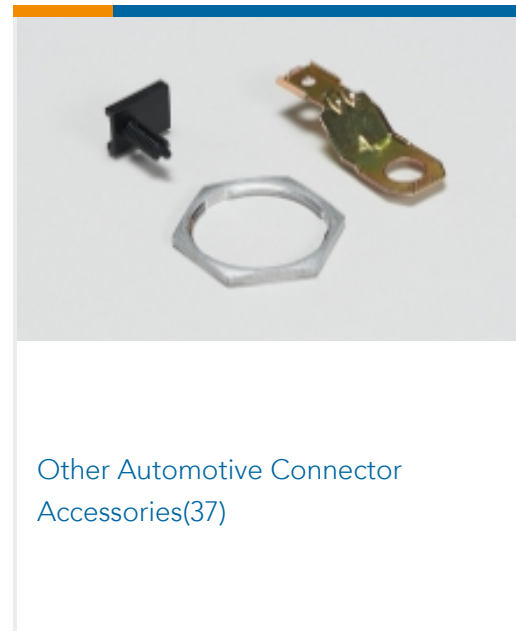

Other Automotive Connector Accessories(37)



PCB Headers & Receptacles(37)

Customers Also Bought



TE Part #1587723-2
INNER FERRULE, SIZE B, HVA280-



TE Part #2103013-1
CABLE SEAL RETAINER, SIZE 1, HVA280



TE Part #1587985-1
INNER HSG SUBASSY, HVA280-2PHM



TE Part #1587723-3
INNER FERRULE, SIZE C, HVA280



TE Part #1-968853-3
AMP MCP 2.8, CONTACT



TE Part #4-2103015-5
PLUG SUBASSY, E, HVA280-2PHM F



TE Part #1587977-2
INNER HOUSING, PLUG, HVA280-2PHM, PASS T



TE Part #2103155-1
COLLET, SIZE 1, HVA280



Documents

Product Drawings

[OUTER FERRULE, SIZE B, HVA280](#)

English

CAD Files

[3D PDF](#)

3D

Customer View Model

[ENG_CVM_CVM_1587724-2_A_c-1587724-2-a.2d_dxf.zip](#)

English

Customer View Model

[ENG_CVM_CVM_1587724-2_A_c-1587724-2-a.3d_igs.zip](#)

English

Customer View Model

[ENG_CVM_CVM_1587724-2_A_c-1587724-2-a.3d_stp.zip](#)

English

By downloading the CAD file I accept and agree to the [Terms and Conditions](#) of use.

Product Specifications

[Application Specification](#)

English

[Application Specification](#)

English

[Application Specification](#)

English

[Application Specification](#)

English