

## **AIMB-505**

**Intel® /Core™ i7/i5/i3 /Pentium/  
Celeron LGA1151 MicroATX with  
VGA/DVI/DP/eDP(LVDS), 10  
COM, Dual LAN, DDR4, PCIe x  
16, PCIe x 1, PCI and SATAIII**

**ADVANTECH**

*Enabling an Intelligent Planet*

---

## Copyright

The documentation and the software included with this product are copyrighted 2016 by Advantech Co., Ltd. All rights are reserved. Advantech Co., Ltd. reserves the right to make improvements in the products described in this manual at any time without notice.

No part of this manual may be reproduced, copied, translated or transmitted in any form or by any means without the prior written permission of Advantech Co., Ltd. Information provided in this manual is intended to be accurate and reliable. However, Advantech Co., Ltd. assumes no responsibility for its use, nor for any infringements of the rights of third parties, which may result from its use.

## Acknowledgements

IBM and PC are trademarks of International Business Machines Corporation.

Intel® Core™ i7/i5/i3 Pentium/Celeron® is trademark of Intel Corporation

All other product names or trademarks are properties of their respective owners.

# A Message to the Customer

## Advantech Customer Services

Each and every Advantech product is built to the most exacting specifications to ensure reliable performance in the harsh and demanding conditions typical of industrial environments. Whether your new Advantech equipment is destined for the laboratory or the factory floor, you can be assured that your product will provide the reliability and ease of operation for which the name Advantech has come to be known.

Your satisfaction is our primary concern. Here is a guide to Advantech's customer services. To ensure you get the full benefit of our services, please follow the instructions below carefully.

## Technical Support

We want you to get the maximum performance from your products. So if you run into technical difficulties, we are here to help. For the most frequently asked questions, you can easily find answers in your product documentation. These answers are normally a lot more detailed than the ones we can give over the phone.

So please consult this manual first. If you still cannot find the answer, gather all the information or questions that apply to your problem, and with the product close at hand, call your dealer. Our dealers are well trained and ready to give you the support you need to get the most from your Advantech products. In fact, most problems reported are minor and are able to be easily solved over the phone.

In addition, free technical support is available from Advantech engineers every business day. We are always ready to give advice on application requirements or specific information on the installation and operation of any of our products.

# Declaration of Conformity

## FCC Class B

This device complies with the requirements in part 15 of the FCC rules:

Operation is subject to the following two conditions:

- This device may not cause harmful interference
- This device must accept any interference received, including interference that may cause undesired operation.

This equipment has been tested and found to comply with the limits for a Class B digital device, pursuant to Part 15 of the FCC Rules. These limits are designed to provide reasonable protection against harmful interference when the equipment is operated in a commercial environment. This equipment generates, uses, and can radiate radio frequency energy and, if not installed and used in accordance with the instruction manual, may cause harmful interference to radio communications. Operation of this device in a residential area is likely to cause harmful interference in which case the user will be required to correct the interference at his/her own expense. The user is advised that any equipment changes or modifications not expressly approved by the party responsible for compliance would void the compliance to FCC regulations and therefore, the user's authority to operate the equipment.

**Caution!** *There is a danger of a new battery exploding if it is incorrectly installed. Do not attempt to recharge, force open, or heat the battery. Replace the battery only with the same or equivalent type recommended by the manufacturer. Discard used batteries according to the manufacturer's instructions.*



## CPU Compatibility

CPU Family	Core Stepping	Power	Freq (GHz)	Mfg. Tech	HT	L2 cache	Smart cache (L3)	Package Type	Result	Supports Model
Intel i7-6700		65W	3.4G	14nm	Y	NA	8MB	LGA1151	PASS	G2/L
Intel i7-6700TE		35W	2.4G	14nm	Y	NA	8MB	LGA1151	PASS	G2/L
Intel i5-6500		65W	3.2G	14nm	Y	NA	6MB	LGA1151	PASS	G2/L
Intel i5-6500TE		35W	2.3G	14nm	Y	NA	6MB	LGA1151	PASS	G2/L
Intel i3-6100		51W	3.7G	14nm	-	NA	4MB	LGA1151	PASS	G2/L
Intel i3-6100TE		35W	2.7G	14nm	-	NA	4MB	LGA1151	PASS	G2/L
Intel Pentium® Processor G4400		54W	3.3G	14nm	-	NA	3MB	LGA1151	PASS	G2/L
Intel Pentium® Processor G4400TE		35W	2.9G	14nm	-	NA	3MB	LGA1151	PASS	G2/L

## Memory Compatibility

Brand	Size	Speed	Type	ECC	Vendor PN	Memory	Result
ADATA	4GB	DDR4 2133	DDR4	N	AD4U2133W4G15-BHYM	H5AN4G8NMFR TFC	PASS
Crucial	4GB	DDR4 2133	DDR4	N	CT4G4DFS8213.C8FA R11	5NA77D9RGQ	PASS
Transcend	4GB	DDR4 2133	DDR4	N	TS512MLH64V1H	SEC 452 BCPB K4A4G085WD	PASS
ADATA	8GB	DDR4 2133	DDR4	N	AD4U2133W8G15-BHYM	H5AN4G8NMFR TFC	PASS
ADATA	16GB	DDR4 2133	DDR4	N	AD4U2133316G15	SEC 601 K4A8G08 5WB BCPB	PASS
Crucial	8GB	DDR4 2133	DDR4	N	CT8G4DFD8213.C16FA R11	5NA77D9RGQ	PASS
Kingston	8GB	DDR4 2133	DDR4	N	KVR21N15D8/8	H5AN4G8BMFR	PASS
Transcend	16GB	DDR4 2133	DDR4	N	STS2GLH64V1B	SEC 546 K4A8G08 5WB BCRC	PASS
Advantech	8GB	DDR4 2133	DDR4	N	AQD-D4U8GN21-SG	SEC 446 BCPB K4A4G085WD	PASS
Advantech	16GB	DDR4 2133	DDR4	N	AQD-D4U16N21-SE	SEC 543 BCPB K4A8G085WB	PASS

## Product Warranty (2 years)

Advantech warrants to you, the original purchaser, that each of its products will be free from defects in materials and workmanship for two years from the date of purchase.

This warranty does not apply to any products which have been repaired or altered by persons other than repair personnel authorized by Advantech, or which have been subject to misuse, abuse, accident or improper installation. Advantech assumes no liability under the terms of this warranty as a consequence of such events.

Because of Advantech's high quality-control standards and rigorous testing, most of our customers never need to use our repair service. If an Advantech product is defective, it will be repaired or replaced at no charge during the warranty period. For out-of-warranty repairs, you will be billed according to the cost of replacement materials, service time and freight. Please consult your dealer for more details.

If you think you have a defective product, follow these steps:

1. Collect all the information about the problem encountered. (For example, CPU speed, Advantech products used, other hardware and software used, etc.) Note anything abnormal and list any onscreen messages you get when the problem occurs.
2. Call your dealer and describe the problem. Please have your manual, product, and any helpful information readily available.
3. If your product is diagnosed as defective, obtain an RMA (return merchandise authorization) number from your dealer. This allows us to process your return more quickly.
4. Carefully pack the defective product, a fully-completed Repair and Replacement Order Card and a photocopy proof of purchase date (such as your sales receipt) in a shippable container. A product returned without proof of the purchase date is not eligible for warranty service.
5. Write the RMA number visibly on the outside of the package and ship it prepaid to your dealer.

## Ordering Information

Part Number	Chip set	Memory	USB 3.0	USB 2.0	VGA	DP	DVI-D	eDP (LVDS)	SATA III	PCIe x16	PCIe x1	PCI x1	COM	TPM	GbE LAN	AMP	mini-PCIe/mSATA**
AIMB-505G2-00A1E	H110	Non-ECC	8	6	1	1	1	1	3	1	2	1	10	(1)	2	1	0/1
AIMB-5052L-00A1E	H110	Non-ECC	2	6	1	1	1	1	3	1	2	0	2	(1)	1	(1)	0/0

\*) BOM options available on MP version.

\*\* there is a BOM option with additional USB 3.0 via controller IC. When mini-PCIe is used, USB 3.0 from external IC won't work, but mSATA will without problem.

## Initial Inspection

Before you begin installing your motherboard, please make sure that the following materials have been shipped:

- 1 x AIMB-505 Intel LGA 1151 Core i7/i5/i3 /Pentium/Celeron Micro ATX Motherboard
- 2 x SATA HDD cable
- 1 x COM 1 to 1 cable
- 2 x COM 1 to 4 cable
- 1 x I/O port bracket
- 1 x Startup manual
- 1 x Warranty card

If any of these items are missing or damaged, contact your distributor or sales representative immediately. We have carefully inspected the AIMB-505 mechanically and electrically before shipment. It should be free of marks and scratches and in perfect working order upon receipt. As you unpack the AIMB-505, check it for signs of shipping damage. (For example, damaged box, scratches, dents, etc.) If it is damaged or it fails to meet the specifications, notify our service department or your local sales representative immediately. Also notify the carrier. Retain the shipping carton and packing material for inspection by the carrier. After inspection, we will make arrangements to repair or replace the unit.

# Contents

<b>Chapter 1</b>	<b>General Information .....</b>	<b>1</b>
1.1	Introduction .....	2
1.2	Features .....	2
1.3	Specifications .....	2
1.3.1	System .....	2
1.3.2	Memory .....	2
1.3.3	Input/Output .....	3
1.3.4	Graphics .....	3
1.3.5	Ethernet LAN .....	3
1.3.6	Industrial features .....	3
1.3.7	Mechanical and environmental specifications .....	4
1.4	Jumpers and Connectors .....	4
	Table 1.1: Jumpers .....	4
	Table 1.2: Connectors .....	5
1.5	Board layout: Jumper and Connector Locations .....	6
	Figure 1.1 Jumper and Connector Location .....	6
	Figure 1.2 I/O Connectors .....	6
1.6	AIMB-505 Board Diagram .....	7
	Figure 1.3 AIMB-505 Block Diagram .....	7
1.7	Safety Precautions .....	7
1.8	Jumper Settings .....	8
1.8.1	How to Set Jumpers .....	8
1.8.2	CMOS Clear (CMOS1) .....	8
	Table 1.3: CMOS1 .....	8
1.8.3	JEDP1: eDP Power 3.3 V/ 5 V/ 12 V Selector .....	9
	Table 1.4: JeDP1: eDP Power 3.3 V/5 V/ 12 V Selector .....	9
1.8.4	JUSBPWR1/2 (USB Power Selection Connector) .....	9
	Table 1.5: JUSBPWR1-2 (USB Power Selection Connector) .....	9
1.8.5	PSON1: ATX, AT Mode Selector .....	10
	Table 1.6: PSON1: ATX, AT Mode Selector .....	10
1.8.6	JIR1+JOB1+JWD1: Watchdog Timer Output, OBS Alarm Option, and CIR interface .....	10
	Table 1.7: JIR1+JOB1+JWD1: Watchdog Timer Output and OBS Alarm Connector .....	10
1.8.7	JSETCOM3/7: COM3/7 RS232, RS422, RS485 Selection .....	11
	Table 1.8: COM2 RS232, RS422, RS485 Selection .....	11
1.8.8	JCASE1: Case Open Sensor .....	11
1.8.9	JCASEOP_SW1: Case Open Selection Pin Header .....	12
	Table 1.9: JCASEOP_SW1: Case Open Selection Pin Header .....	12
1.8.10	JSETCOM1_V1/JSETCOM2_V1: COM1/COM2_RI# Pin RI# / 5V / 12V .....	12
1.9	System Memory .....	12
1.10	Memory Installation Procedures .....	12
1.11	Cache Memory .....	13
1.12	Processor Installation .....	13
<b>Chapter 2</b>	<b>Connecting Peripherals .....</b>	<b>15</b>
2.1	Introduction .....	16
2.2	USB Ports (LAN1_USB12/LAN2_USB34/USB78910/USB56/USB1112/ USB1314) .....	16
	Table 2.1: LAN LED Indicator .....	16
2.3	USB Power Switch (JUSBPWR1/JUSBPWR2) .....	17
2.4	VGA1/DVI-D Connector (VGA1+DVI 1) Connector .....	18

2.5	Serial Ports (COM1~COM10) .....	19
2.6	Display Port (DP1) .....	20
2.7	PS/2 Keyboard and Mouse Connector .....	21
2.8	CPU Fan Connector (CPU_FAN1) .....	21
2.9	System FAN Connector (SYSFAN1/2/3/4) .....	22
2.10	Front Panel Connectors (JFP1/JFP2).....	23
	2.10.1 ATX soft power switch (JFP1/PWR_SW) .....	23
	2.10.2 Reset (JFP1/RESET).....	23
	2.10.3 HDD LED (JFP1/HDDLED) .....	23
	2.10.4 External speaker (JFP1/SPEAKER).....	23
	2.10.5 Power LED and keyboard lock connector (JFP2/PWR_LED & KEY LOCK).....	24
	Table 2.2: ATX Power Supply LED Status (No support for AT power)	24
2.11	Line Out, Mic In Connector (AUDIO1) .....	24
2.12	Serial ATA Interface (SATA1 ~ SATA3).....	25
2.13	8-pin Alarm Board Connector (VOLT1).....	26
2.14	ATX Power Connector (EATXPWR1, ATX12V1).....	27
2.15	General purpose I/O Connector (GPIO1) .....	28
2.16	eDP/LVDS Connector (eDP1/LVDS) .....	28
2.17	EDP Backlight inverter(INV1).....	29
2.18	JEDP1 .....	29
<b>Chapter 3</b>	<b>BIOS Operation .....</b>	<b>31</b>
3.1	Introduction .....	32
3.2	BIOS Setup .....	32
	3.2.1 Main Menu .....	33
	3.2.2 Advanced BIOS Features .....	34
3.3	Chipset Configuration Setting .....	59
	3.3.1 System Agent (SA) Configuration .....	60
	3.3.2 PCH-IO Configuration .....	66
3.4	Security Setting.....	72
3.5	Boot Setting .....	73
3.6	Save & Exit Configuration .....	74
<b>Chapter 4</b>	<b>Software Introduction &amp; Service .....</b>	<b>77</b>
4.1	Introduction .....	78
4.2	Value-Added Software Services .....	78
	4.2.1 Software API .....	78
	4.2.2 Software Utility .....	80
<b>Chapter 5</b>	<b>Chipset Software Installation Utility</b>	<b>81</b>
5.1	Before You Begin .....	82
5.2	Introduction .....	82
5.3	Windows 8.1 Driver Setup .....	83
<b>Chapter 6</b>	<b>VGA Setup .....</b>	<b>85</b>
6.1	Introduction .....	86
6.2	Windows 8.1 VGA Driver Installation .....	86
<b>Chapter 7</b>	<b>LAN Configuration .....</b>	<b>87</b>



7.1	Introduction .....	88
7.2	Features .....	88
7.3	Installation .....	88
7.4	Windows® 8.1 Driver Setup (Realtek 8111G).....	89

## Appendix A Programming the Watchdog Timer..91

A.1	Programming the Watchdog Timer .....	92
A.1.1	Watchdog Timer Overview.....	92
A.1.2	Programming the Watchdog Timer .....	92
	Table A.1: Watchdog Timer Registers .....	94
A.1.3	Example Program .....	95

## Appendix B Pin Assignments .....99

B.1	Digital Visual Interface connector (DVI1) .....	100
B.2	Video Graphics Array connector (VGA1) .....	100
B.3	Keyboard & Mouse connector (KBMS1) .....	101
B.4	DisplayPort1(DP1) .....	101
B.5	COM1 connector (COM1) .....	102
B.6	Universal Serial Bus Port 7 / 8 / 9 / 10 (USB78910) .....	102
B.7	COM1 RI# selection pin header (JSETCOM1_V1) .....	103
B.8	RJ45 + USB3.0 stack connector (LAN1_USB12) .....	103
B.9	USB Power selection header #2 (JUSBPWR2) .....	104
B.10	RJ45 + USB3.0 stack connector (LAN2_USB34) .....	104
B.11	HD Audio Interface (AUDIO1).....	105
B.12	Volume adjust reserve jumper(VOL_ADJ1) .....	105
B.13	Voltage selector for EDP1 connector (JEDP1) .....	105
B.14	Front panel audio pin header (FPAUD1).....	106
B.15	HD Audio interface (SPDIF1).....	106
B.16	EDP Backlight inverter power connector (INV1) .....	106
B.17	Embedded DisplayPort (EDP1).....	107
B.18	LVDS VCON pull HI/pull Low selection (JLVDS_VCON1).....	107
B.19	LVDS Panel Connector (LVDS1) .....	108
B.20	PCI Express x1 slot (PCIEX1_1).....	109
B.21	USB Power selection header #1 (JUSBPWR1) .....	109
B.22	COM3 ~ COM6 box header (COM3456).....	109
B.23	COM7 ~ COM10 box header (COM78910).....	110
B.24	COM7 RS232,RS422,RS485 selection pin header (JSETCOM7) .....	111
B.25	Dual USB2.0 Port5/6 pin header (USB56).....	111
B.26	System Fan #3 connector (SYSFAN3) .....	112
B.27	COM3 RS232,RS422,RS485 selection pin header (JSETCOM3) .....	112
B.28	16-bits General Purpose I/O pin header (GPIO1).....	113
B.29	Alarm Board/CMM Power Connector (VOLT1) .....	113
B.30	Serial ATA interface connector (SATA1 / SATA2 / SATA3).....	114
B.31	CMOS Mode selection (JCMOS1) .....	114
B.32	Clear RTC jumper (JRTC1).....	114
B.33	Power switch/HDD LED/SMBus/Speaker pin header (JFP1) .....	115
B.34	Power LED and keyboard lock pin header (JFP2) .....	115
B.35	SPI Pin Header (SPI_CN1) .....	115
B.36	System Fan #2 connector (SYSFAN2) .....	116
B.37	Dual port USB3.0 header (USB1112) .....	116
B.38	ATX 24pin power connector (EATXPWR1).....	117
B.39	Dual port USB3.0 header (USB1314) .....	117
B.40	CIR interface, Watchdog timer output and OBS beep (JIR1+JOBS1+JWDT1).....	118
B.41	AT/ATX Mode selection (PSON1).....	118
B.42	COM2 box header (COM2) .....	118
B.43	COM2 RI# selection pin header (JSETCOM2_V1).....	119

B.44	Case Open selection pin header (JCASEOP_SW1).....	119
B.45	Case Open connector (JCASE1).....	119
B.46	LAN LED (LANLED1).....	120
B.47	CPU FAN connector (CPUFAN1).....	120
B.48	SMBus connector from PCH (SMBUS1).....	120
B.49	System Fan #1 connector (SYSFAN1).....	121
B.50	ATX 4 Pin main power connector (ATX12V1).....	121
B.51	Low pin count interface connector (LPC1).....	121
B.52	Jumper Setting List .....	122
	B.52.1 USB VBUS selection for LAN1_USB12, LAN2_USB34, USB78910 (JUSBPWR2).....	122
	B.52.2 USB VBUS selection for USB56, USB1112, USB1314 (JUSBPWR1).....	122
	B.52.3 Voltage selection for EDP1 connector (JEDP1) .....	123
	B.52.4 CMOS clear (JCMOS1).....	123
	B.52.5 PWRBTN#/ RESET#/HDD LED/ Serial bus from HW monitor IC/ Internal Buzzer /.....	123
	B.52.6 CIR interface, Watchdog timer output and OBS beep (JIR1+JOBS1+JWDT1) .....	124
	B.52.7 AT / ATX Mode selection (PSON1) .....	124
	B.52.8 COM3 RS232, RS422, RS485 selection pin header (JSETCOM3) 125	
	B.52.9 Case open selection pin header (JCASEOP_SW1).....	125
	B.52.10 COM1_RI# Pin RI# / 5V / 12V selection (JSETCOM1_V1).....	126
	B.52.11 COM2_RI# Pin RI# / 5V / 12V selection (JSETCOM2_V1).....	126
	B.52.12 COM7 RS232, RS422, RS485 selection pin header (JSETCOM7) 127	
	B.52.13 LVDS VESA, JEIDA format selection pin header (JLVDS_VCON1) 127	

# Chapter 1

General Information

## 1.1 Introduction

AIMB-505 is designed with the Intel H110 for industrial applications that require both performance computing and enhanced power management capabilities. The motherboard supports Core i7-6700 3.4GHz/ Core i5-6500 3.2GHz/ Core i3-6100 3.7 GHz/ Pentium G4400 3.3 GHz/ Celeron G3900 2.8 GHz processor up to 8 MB L3 cache and DDR4 2133 MHz up to 32GB, per slot up to 16 GB. A rich I/O connectivity of 10 serial ports, 6 USB 2.0, 8 USB 3.0, dual GbE LAN, 3 SATA III ports.

## 1.2 Features

- **Rich I/O connectivity:** Dual GbE LAN via PCIe x1 bus, 1 x PCIe x16 slot (Gen 3), 2 x PCIe x1 slot (Gen 2), 1 x PCI, 6 x USB 2.0 ports and 8 x USB 3.0 ports.
- **Standard Micro ATX form factor with industrial features:** The AIMB-505 is a full featured Micro ATX motherboard with balanced expendability and performance.
- **Wide selection of storage devices:** SATAIII HDD, customers benefit from the flexibility of using the most suitable storage device for larger capacity.
- **Optimized integrated graphic solution:** With Intel® Flexible Display Interface, it supports versatile display options and 32-bit 3D graphics engine.

## 1.3 Specifications

### 1.3.1 System

- **CPU:** Intel 6th generation Core i7/i5/i3 /Pentium/Celeron processor
- **BIOS:** AMI EFI 128 Mbit SPI BIOS
- **System chipset:** Intel® H110
- **SATA hard disk drive interface:** Three on-board SATA connectors with data transmission rate up to 600 MB

### 1.3.2 Memory

- **RAM:** Up to 32 GB in 2 slots 288-pin DIMM sockets. Supports dual-channel DDR4 2133MHz SDRAM.
  - AIMB-505G2 & AIMB-505L supports non-ECC unbuffered DIMMs and do not support any memory configuration that mixes non-ECC with ECC unbuffered DIMMs.

**Note!** A 32-bit OS may not fully detect 4GB of RAM when 4 GB is installed.



### 1.3.3 Input/Output

- **PCIe slot:** 1 PCIe x16 expansion slot, 2 PCIe x 1 expansion slot, 1 PCI
- **Serial port:** Ten serial ports, two is RS-232/422/485 with hardware auto-flow control and eight are RS-232. One DB-9 connectors located in rear panel are RS-232.
- **Keyboard and PS/2 mouse connector:** Two 6-pin mini-DIN connectors are located on the mounting bracket for easy connection to PS/2 keyboard and mouse.
- **USB port:** Supports up to 6 USB 2.0 ports with transmission rates up to 480 Mbps and 8 USB 3.0 ports with transmission rates up to 5 Gbps.

**Note!** *Under Window 7 OS, all of USB 2.0/3.0 ports are not workable before XHCI driver is installed. Suggest to use PS/2 keyboard & mouse for XHCI driver install first.*



- **GPIO:** AIMB-505 supports 8-bit GPIO from super I/O for general purpose control application.

### 1.3.4 Graphics

- **Controller:** Intel® HD Graphics
- **Display memory:** 1 GB maximum shared memory with 2GB and above system memory installed
- **DVI:** Supports DVI up to resolution 1920 x 1200 @ 60Hz refresh rate
- **VGA:** Supports VGA up to resolution 1920 x 1200 @ 60Hz refresh rate
- **Display Port:** Supports max resolution 4096 x 2304 @60Hz
- **eDP:** Supports max resolution 3840 x 2160 @ 60Hz
- **LVDS (BOM option eDP):** Support max resolution 1920 x 1200
- **Dual Display:** VGA+eDP/LVDS, VGA+DVI, eDP/LVDS+ DVI, LVDS + DP, DP+ DVI, eDP/LVDS+DP

### 1.3.5 Ethernet LAN

- Supports dual 10/100/1000 Mbps Ethernet port (s) via PCI Express x1 bus which provides 500 MB/s data transmission rate
- **Controller:** LAN1: Realtek 8111G; LAN2: Intel Realtek 8111G

### 1.3.6 Industrial features

- **Watchdog timer:** Can generate a system reset. The watchdog timer is programmable, with each unit equal to one second or one minute (255 levels)

### 1.3.7 Mechanical and environmental specifications

- **Operating temperature:** 0 ~ 60° C (32 ~ 140° F, Depending on CPU)
- **Storage temperature:** -40 ~ 85° C (-40 ~ 185° F)
- **Humidity:** 5 ~ 95% non-condensing
- **Power supply voltage:** +3.3 V, +5 V, +12 V, -12 V, 5 Vsb
- **Power consumption:**  
LAG1151 Core i7-6700 3.4 GHz, 8MB L3 Cache, 4pcs 8GB DDR4 2133MHz memory  
+5 V    3.3 V    12 V    5 Vsb    -12 V  
1.73 A   1.92 A    3.45 A    0.18 A    0.09 A  
Measure the maximum current value which system under maximum load (CPU: Top speed, RAM & Graphic: Full loading)
- **Board size:** 244 mm x 244 mm (9.6" x 9.6")
- **Board weight:** 0.365 kg

## 1.4 Jumpers and Connectors

Connectors on the AIMB-505 motherboard link it to devices such as hard disk drives and a keyboard. In addition, the board has a number of jumpers used to configure your system for your application.

The tables below list the function of each of the board jumpers and connectors. Later sections in this chapter give instructions on setting jumpers. Chapter 2 gives instructions for connecting external devices to your motherboard.

**Table 1.1: Jumpers**

Label	Function
JFP1	Power Switch/ Reset/ External Speaker/ SATA HDD LED/ SMBus connector
JFP2	Power LED/ Keyboard Lock
JSETCOM3/7	Serial port:RS232/RS422/RS485 jumper setting
JCMOS1	CMOS clear (default 1-2 pin)
JCASE1	Case open connector
JEDP1	eDP power jumper
JIR1+JOBS1 +JWDT1	Jumper for CIR/Watchdog/OBS
JUSBPWR2	USB power selection for LAN1_USB12/ LAN2_USB34/ USB561112
JUSBPWR1	USB power selection for USB78/ USB910/ USB1516

**Table 1.2: Connectors**

<b>Label</b>	<b>Function</b>
COM1	Serial Port 1 (RS-232)
COM2	Serial Port COM2, pin header 2 x 5, COM2 supports RS232/422/485
COM3/4/5/6	Serial port: COM 3/4/5/6, box header 2x 20
DP1+ HDMI	Display Port Connector (top) and HDMI connector (bottom)
DVI1	DVI connector
LAN1_USB12	LAN1 & USB12 Connector
LAN2_USB34	LAN2 & USB34 Connector
LANLED1	Front Panel LAN Indicator connector
USB5/6/11/12	USB port 5-6, 11-12
USB 7/8/9/10	USB 7/8/9/10 (internal 2 x 10 pin header on board)
USB 15/16	USB 15/16 from Renesas (internal 2 x 10 pin header on board) (Optional)
SATA1-4	Serial III ATA connector
CPUFAN1	CPU FAN connector (4 pin)
SYS-FAN1/2/3/4	System FAN Power Connector (4 pin) (Fan3/Fan4 Optional)
eDP1	eDP connector (2 x 10 pin header)
KBMS1	On board external keyboard and Mouse connector
AUDIO1	Line Out, Mic IN connector
FPAUDIO1	Front Panel audio connector (FP_AU-DIO)
PSON1	AT(1-2) / ATX(2-3) (Default 2-3)
SPI_CN1	SPI flash programming connector
GPIO1	GPIO pin header (SMD pitch=2.0 mm)
SMBUS1	SMBUS expansion pin header 1 x 4 p
ATX12V1	ATX 4pin 12V Auxiliary power connector
EATXPWR1	ATX 24pin power connector
INV1	ePD inverter
VOLT1	Voltage Display connector
SPDIF1	Digital Audio connector 4 x 1 header pitch = 2.54 mm
LPC1	Low pin count interface (2 x 7 pin header)

# 1.5 Board layout: Jumper and Connector Locations

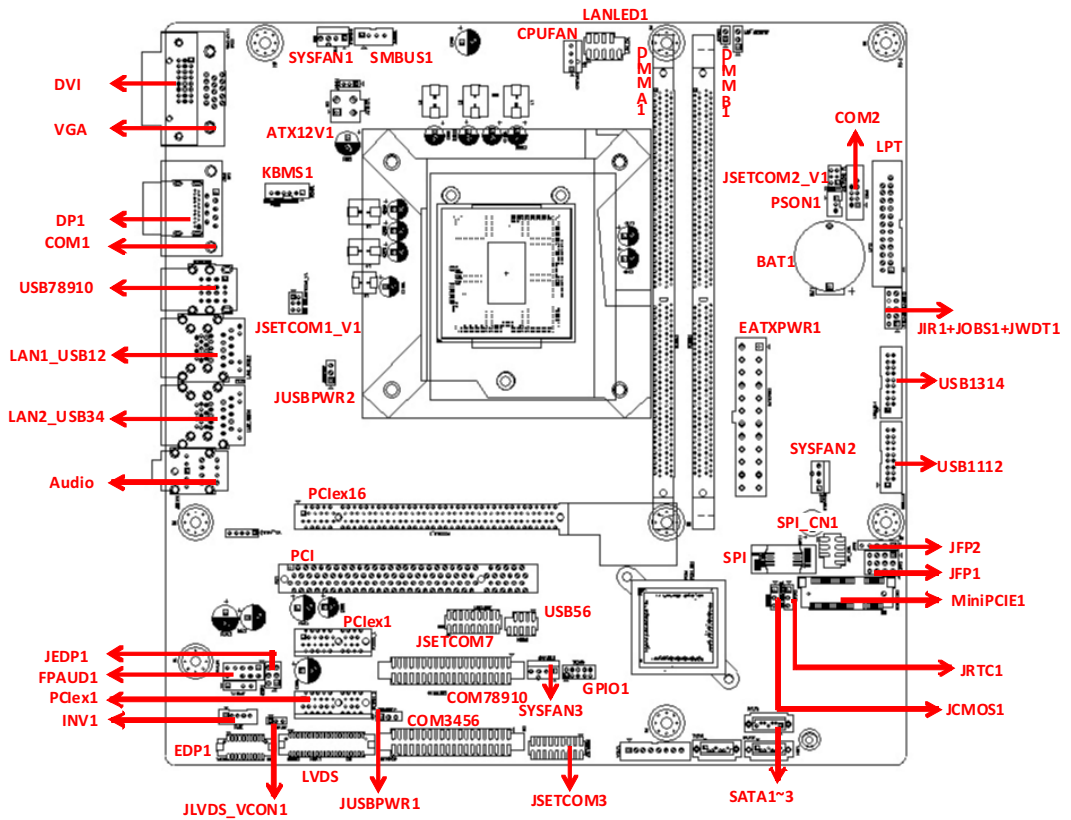

Figure 1.1 Jumper and Connector Location



Figure 1.2 I/O Connectors



## 1.6 AIMB-505 Board Diagram

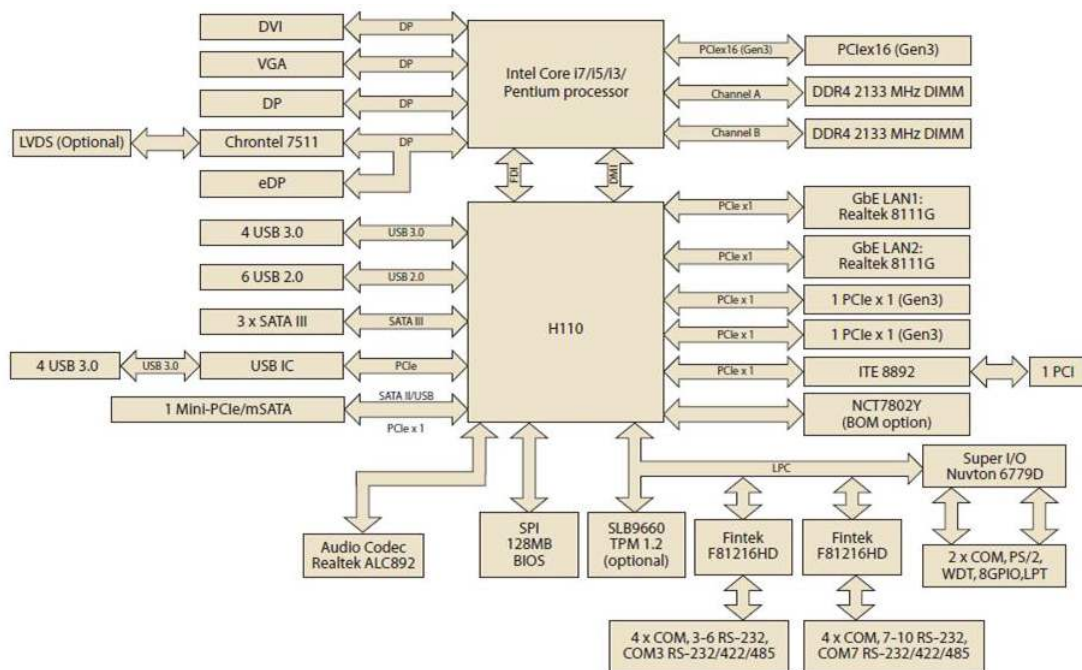

Figure 1.3 AIMB-505 Block Diagram

## 1.7 Safety Precautions

**Warning!** Always completely disconnect the power cord from chassis whenever you work with the hardware. Do not make connections while the power is on. Sensitive electronic components can be damaged by sudden power surges. Only experienced electronics personnel should open the PC chassis.



**Caution!** Always ground yourself to remove any static charge before touching the motherboard. Modern electronic devices are very sensitive to electrostatic discharges. As a safety precaution, use a grounding wrist strap at all times. Place all electronic components on a static-dissipative surface or in a static-shielded bag when they are not in the chassis.



**Caution!** The computer is provided with a battery-powered real-time clock circuit. There is a danger of explosion if battery is incorrectly replaced. Replace only with same or equivalent type recommended by the manufacturer. Discard used batteries according to manufacturer's instructions.



**Caution!** There is a danger of a new battery exploding if it is incorrectly installed. Do not attempt to recharge, force open, or heat the battery. Replace the battery only with the same or equivalent type recommended by the manufacturer. Discard used batteries according to the manufacturer's instructions.



## 1.8 Jumper Settings

This section provides instructions on how to configure your motherboard by setting the jumpers. It also includes the motherboards's default settings and your options for each jumper.



### 1.8.1 How to Set Jumpers

You can configure your motherboard to match the needs of your application by setting the jumpers. A jumper is a metal bridge that closes an electrical circuit. It consists of two metal pins and a small metal clip (often protected by a plastic cover) that slides over the pins to connect them. To “close” (or turn ON) a jumper, you connect the pins with the clip. To “open” (or turn OFF) a jumper, you remove the clip. Sometimes a jumper consists of a set of three pins, labeled 1, 2, and 3. In this case you connect either pins 1 and 2, or 2 and 3. A pair of needle-nose pliers may be useful when setting jumpers.

### 1.8.2 CMOS Clear (CMOS1)

The AIMB-505 motherboard contains a jumper that can erase CMOS data and reset the system BIOS information. Normally this jumper should be set with pins 1-2 closed. If you want to reset the CMOS data, set CMOS1 to 2-3 closed for just a few seconds, and then move the jumper back to 1-2 closed. This procedure will reset the CMOS to its default setting.

**Table 1.3: CMOS1**

Function	Jumper Setting
*Keep CMOS data	 1-2 closed
Clear CMOS data	 2-3 closed

\* Default

### 1.8.3 JEDP1: eDP Power 3.3 V/ 5 V/ 12 V Selector

**Table 1.4: JeDP1: eDP Power 3.3 V/5 V/ 12 V Selector**

Closed Pins	Result
*JEDP1, 4-6	Jumper for +3.3 V
EDP1, 2-4	Jumper for +5 V
JEDP1, 3-4	Jumper for +12 V
*Default	

Jumper position for +3.3V (Default)	
Jumper position for +5V	
Jumper position for +12V	

### 1.8.4 JUSBPWR1/2 (USB Power Selection Connector)

JUSBPWR1: selection for USB56, USB1112, USB1314

JUSBPWR2: selection for LAN1\_USB12, LAN2\_USB34, USB78910

**Table 1.5: JUSBPWR1-2 (USB Power Selection Connector)**

Pin	Pin Name
1	+V5_Vsb
2	+V5_USB
3	+V5

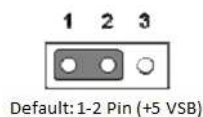

## 1.8.5 PSON1: ATX, AT Mode Selector

**Table 1.6: PSON1: ATX, AT Mode Selector**

Closed Pins	Result
1-2	AT Mode
2-3*	ATX Mode

\*Default

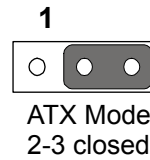
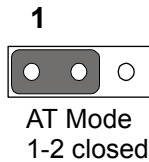

## 1.8.6 JIR1+JOB1+JWD1: Watchdog Timer Output, OBS Alarm Option, and CIR interface

**Table 1.7: JIR1+JOB1+JWD1: Watchdog Timer Output and OBS Alarm Connector**

Pin	Pin Name
1	+V5
2	NC
3	NC
4	Watch dog reset# output
5	IRRX
6	System reset input#
7	GND
8	SIO Warning Beep output
9	IRTX
10	SP1 Buzzer Beep input

**Note!** Watch dog time-out reset# (4-6 short) / SIO Warning Beep enable (8-10 short).

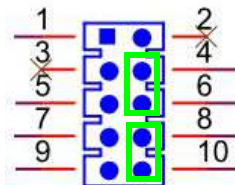

## 1.8.7 JSETCOM3/7: COM3/7 RS232, RS422, RS485 Selection

**Table 1.8: COM2 RS232, RS422, RS485 Selection**

Pin	Signal	Pin	Signal
1	UART_SIN [2]	2	RXD_RS485
3	UART_SIN [2]	4	RXD_RS422
5	UART_SIN [2]	6	RXD_RS232
7	DCDB	8	SOUT [2]
9	COM2_DCD#	10	COM2_SOUT
11	COM2_TXD485-	12	COM2_RXD485+
13	SIN [B]	14	DTR [B]
15	COM2_SIN	16	COM2_DTR#
17	COM2_TXD485+	18	COM2_RXD485-

RS-232 Mode (Default)  
(5-6) (7-9) (8-10) (13-15) (14-16)

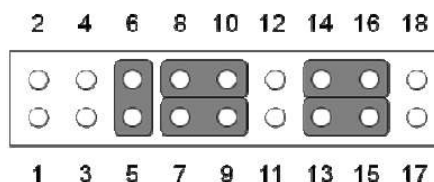

RS-422 Mode  
(3-4) (9-11) (10-12) (15-17) (16-18)

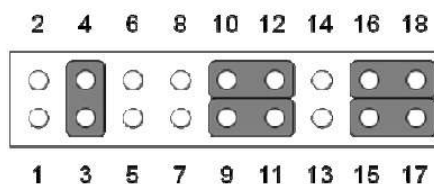

RS-485 Mode  
(1-2) (9-11) (10-12) (15-17) (16-18)

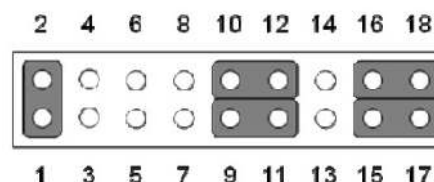

## 1.8.8 JCASE1: Case Open Sensor

The AIMB-505 motherboard contains a jumper that provides a chassis open sensor. The buzzer on the motherboard beeps when the case is opened.

## 1.8.9 JCASEOP\_SW1: Case Open Selection Pin Header

**Table 1.9: JCASEOP\_SW1: Case Open Selection Pin Header**

Closed Pins	Result
1-2	Normal Mode
2-3*	Normal Open (Default)

\*Default

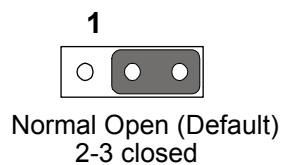
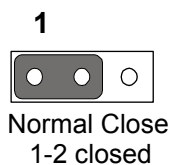

## 1.8.10 JSETCOM1\_V1/JSETCOM2\_V1: COM1/COM2\_RI# Pin RI# / 5V / 12V

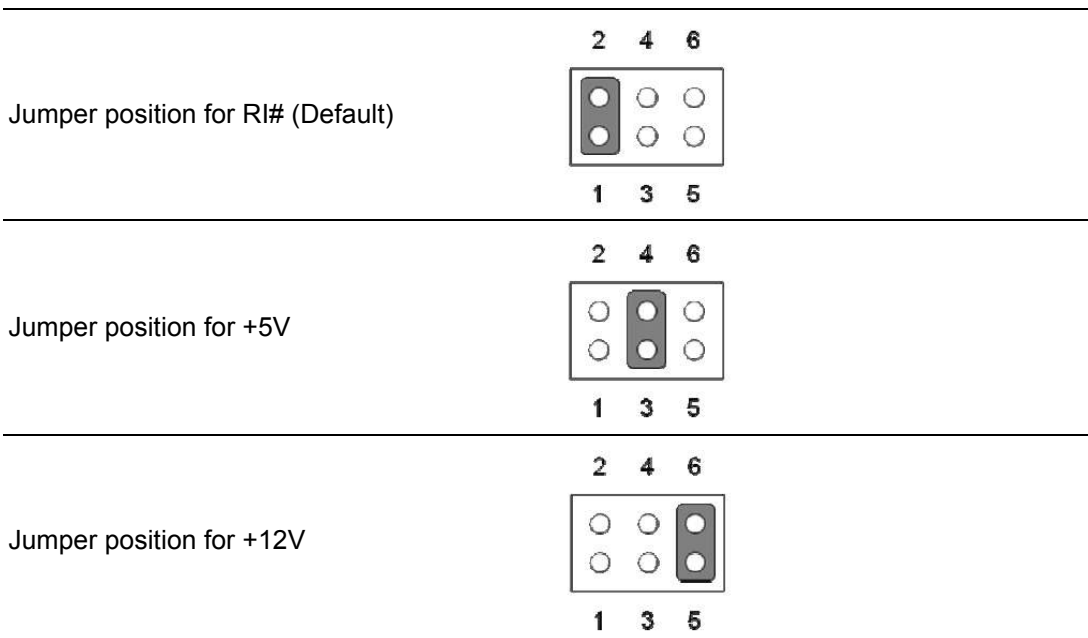

## 1.9 System Memory

AIMB-505 has four 288-pin memory sockets for 2133 MHz memory modules with maximum capacity of 32 GB (Maximum 16 GB for each DIMM).

## 1.10 Memory Installation Procedures

To install DIMMs, first make sure the two handles of the DIMM socket are in the “open” position, i.e., the handles lean outward. Slowly slide the DIMM module along the plastic guides on both ends of the socket. Then firmly but gently (avoid pushing down too hard) press the DIMM module well down into the socket, until you hear a click when the two handles have automatically locked the memory module into the correct position of the DIMM socket. To remove the memory module, just push both handles outward, and the memory module will be ejected by the mechanism.

## 1.11 Cache Memory

The AIMB-505 supports a CPU with one of the following built-in full speed L3 caches:

8MB for Intel Core i7 6700

8MB for Intel Core i7 6700TE

6MB for Intel Core i5 6500

6MB for Intel Core i5 6500TE

4MB for Intel Core i3 6100

4MB for Intel Core i3 6100TE

3MB for Intel Pentium G4400/G4400TE

2MB for Intel Celeron G3900/G3900TE

The built-in second-level cache in the processor yields much higher performance than conventional external cache memories.

## 1.12 Processor Installation

The AIMB-505 is designed for LGA1151, Intel Core i7/Core i5/Core i3/Pentium/Celeron processor.





# Chapter 2

Connecting  
Peripherals

## 2.1 Introduction

You can access most of the connectors from the top of the board as it is being installed in the chassis. If you have a number of cards installed or have a packed chassis, you may need to partially remove the card to make all the connections.

## 2.2 USB Ports (LAN1\_USB12/LAN2\_USB34/USB78910/USB56/USB1112/USB1314)

The AIMB-505 provides up to 14 USB ports. The USB interface complies with USB Specification Rev 2.0 supporting transmission rates up to 480 Mbps and Rev 3.0 supporting transmission rate up to 5 Gbps and is fuse protected. The USB interface can be disabled in the system BIOS setup.

The AIMB-505 is equipped with two high-performance 1000 Mbps Ethernet LAN adapters, both of which are supported by all major network operating systems. The RJ-45 jacks on the rear panel provide convenient LAN connection.

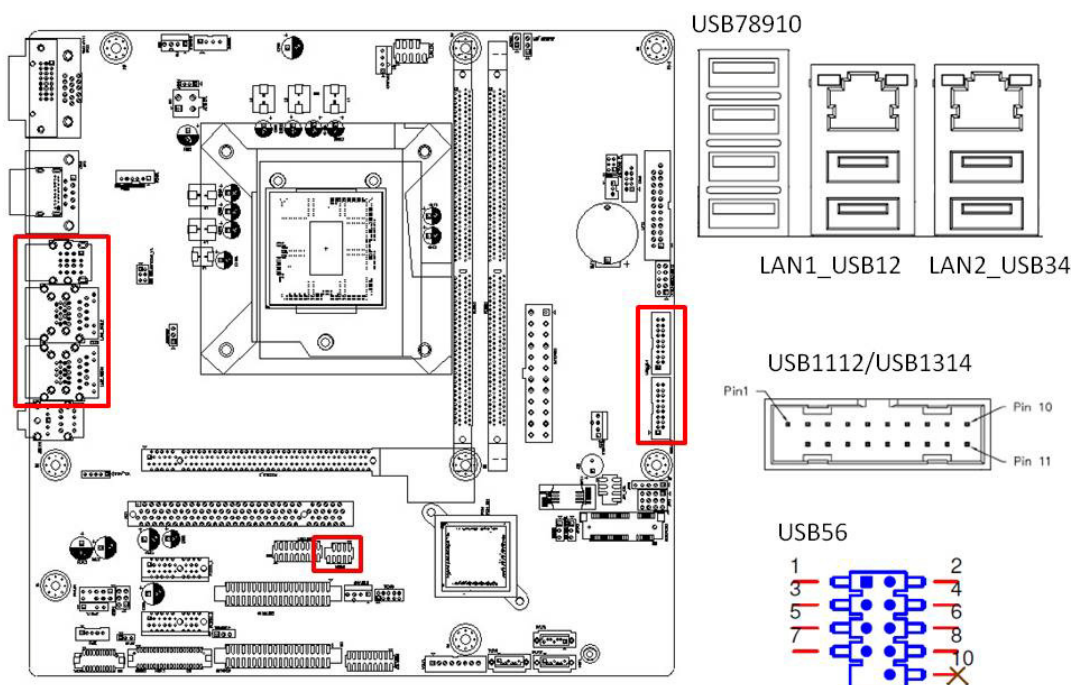

**Table 2.1: LAN LED Indicator**

LAN Mode	LAN Indicator	
LAN1 indicator	LED1 (Right)	off for mal-link; Link (On) / Active (Flash)
	LED2 (Left)	100 Mbps (On) / 10 Mbps (Off); Color: Orange
	LED2 (Left)	1000 Mbps (On); Color: Green
LAN2 indicator	LED1 (Right)	off for mal-link; Link (On) / Active (Flash)
	LED2 (Left)	100 Mbps (On) / 10 Mbps (Off); Color: Orange
	LED2 (Left)	1000 Mbps (On); Color: Green

**Note!** USB1112,USB1314 is external USB controller. BOM option with miniP-Cle.



(Default supports USB1112/USB1314, miniPCle only support mSATA)  
USB1112/USB1314 can't support wake up function.

## 2.3 USB Power Switch (JUSBPWR1/JUSBPWR2)

AIMB-505 allows users to set USB power between +5 VSB and +5 V. When the jumper is set to +5 V (default 2-3 pin), the board doesn't support wake on from S3 via keyboard or mouse. If you need to set it to +5 Vsb, you need to modify the jumper (1-2 pin). There is another way to control USB power by GPIO. But this kind of method need to have BOM option applied in HW design. Each GPIO can control all rear USB ports or all USB ports on board pin header.

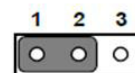
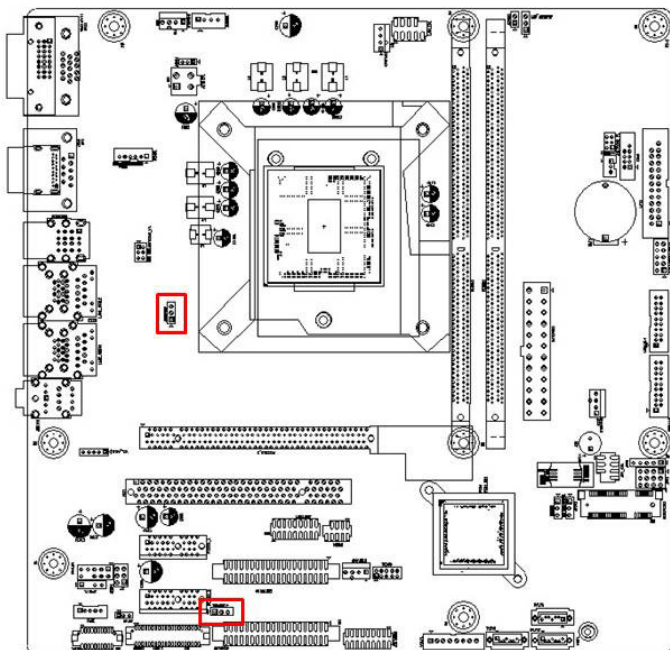

Pins	Result
1-2*	Set USB VBUS as +5VSB
2-3	Set USB VBUS as +5V

**Note!** When USB power is switched to +5V, it can't be connected with power KVM.



## 2.4 VGA1/DVI-D Connector (VGA1+DVI 1) Connector

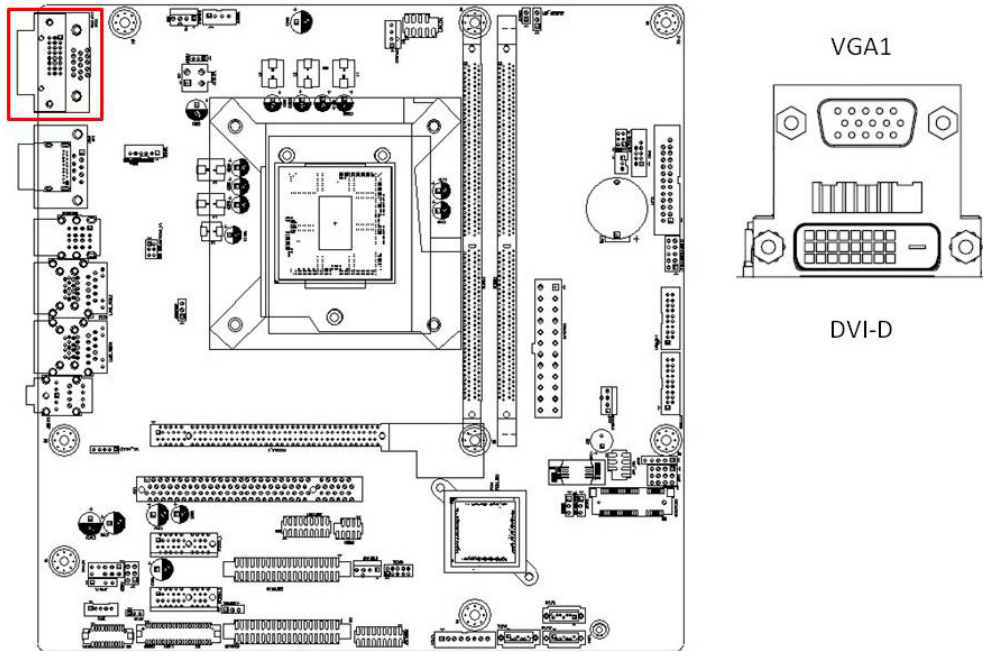

AIMB-505 includes VGA1 and DVI interfaces that can drive conventional VGA1 and DVI displays. Pin assignments for COM1 and DVI connectors are detailed in Appendix B.

## 2.5 Serial Ports (COM1~COM10)

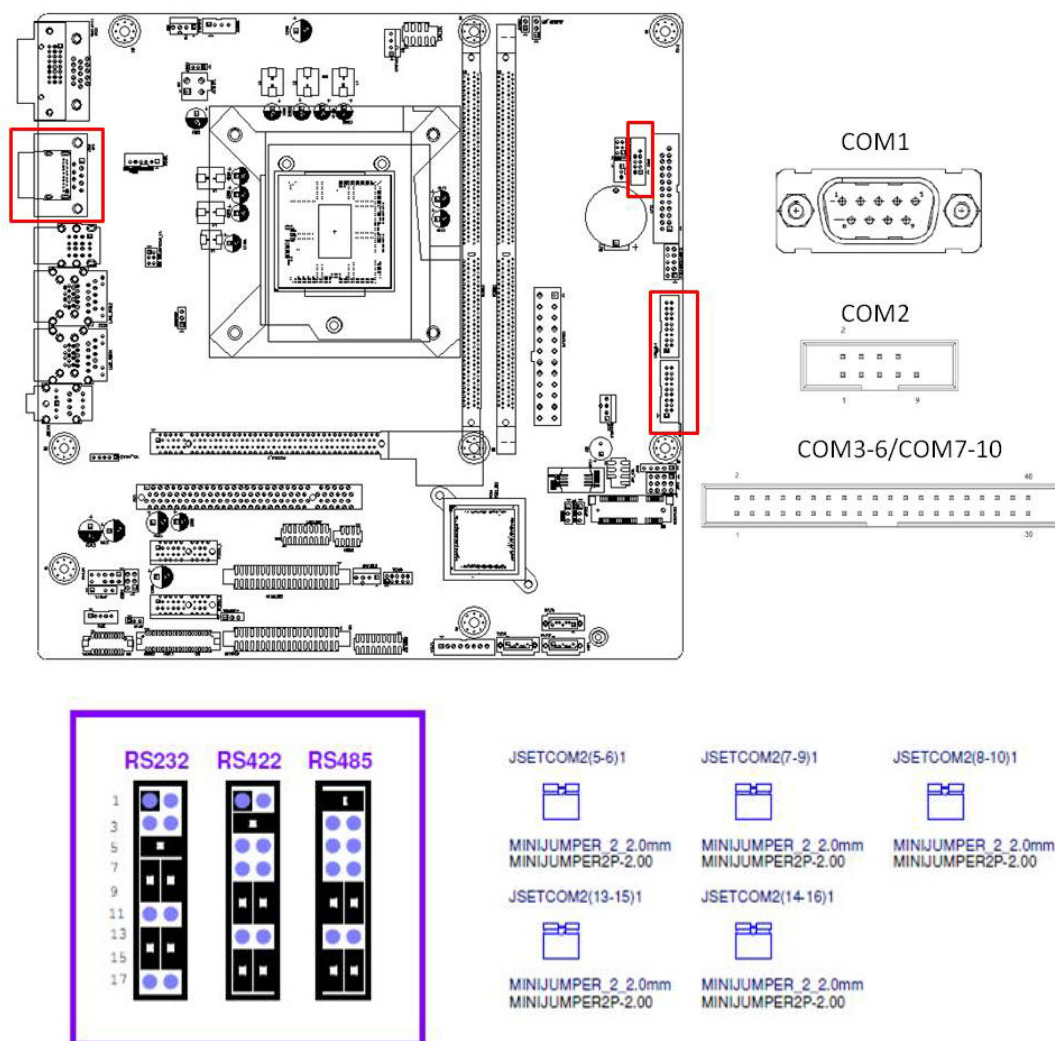

AIMB-505 supports six serial ports. COM1, COM2, COM3, COM7-10 support RS-232. COM1/2 support RS-232 (with 5V/12V power). JSETCOM3/7 is used to select the RS-232/422/485 mode for COM3/7.

These ports can connect to serial devices, such as a mouse or a printer, or to a communications network.

The IRQ and address ranges for both ports are fixed. However, if you want to disable the port or change these parameters later, you can do this in the system BIOS setup. Different devices implement the RS-232 standards in different ways. If you have problems with a serial device, be sure to check the pin assignments for the connector.

## 2.6 Display Port (DP1)

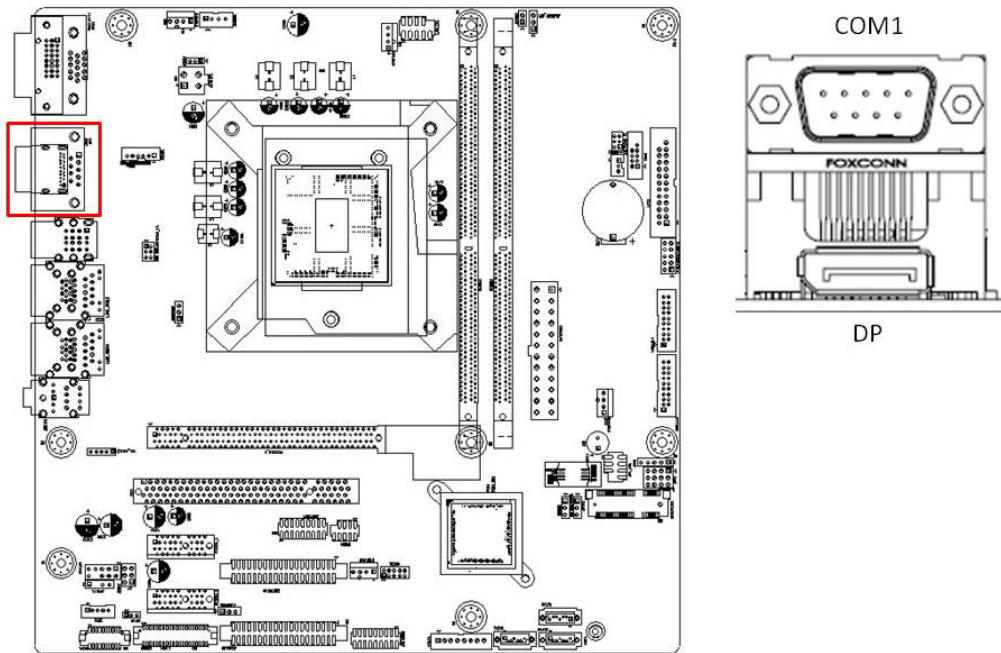

AIMB-505 has one external COM1/DP connector to supports the COM port (RS-232) and Display Port panel.

COM1 is a standard 9-pin connector support RS-232. Support 5V or 12V input, can be changed by jumper JSETCOM1\_V1.

DP max resolution support to 4096 x 2304 @ 60 Hz



## 2.7 PS/2 Keyboard and Mouse Connector

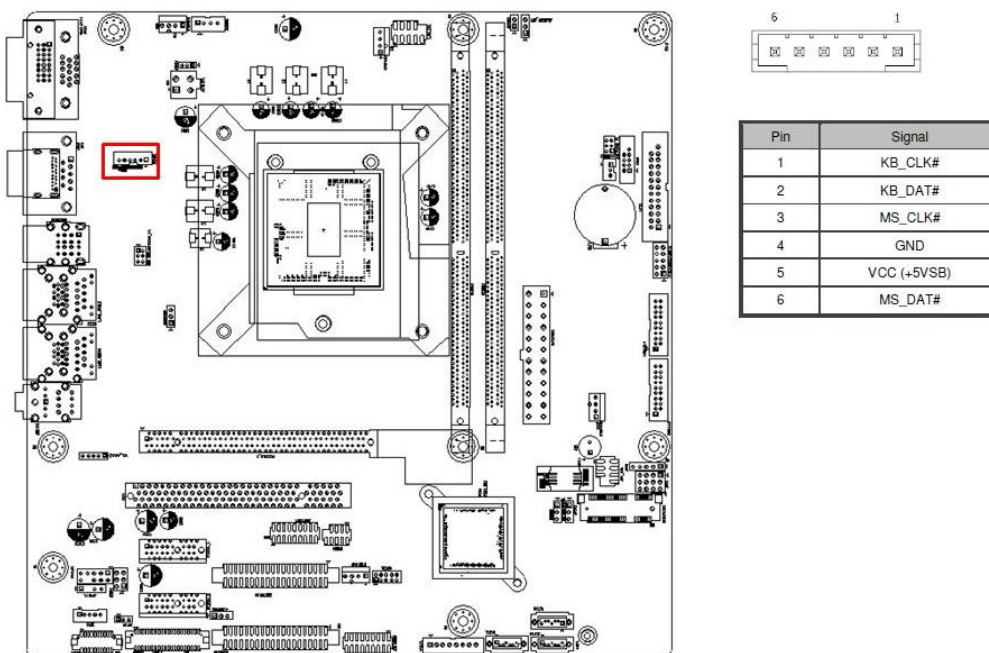

6-pin mini-DIN connectors (KBMS1) is for supporting the PS/2 keyboard and PS/2 mouse by a cable P/N 1703060191.

## 2.8 CPU Fan Connector (CPU\_FAN1)

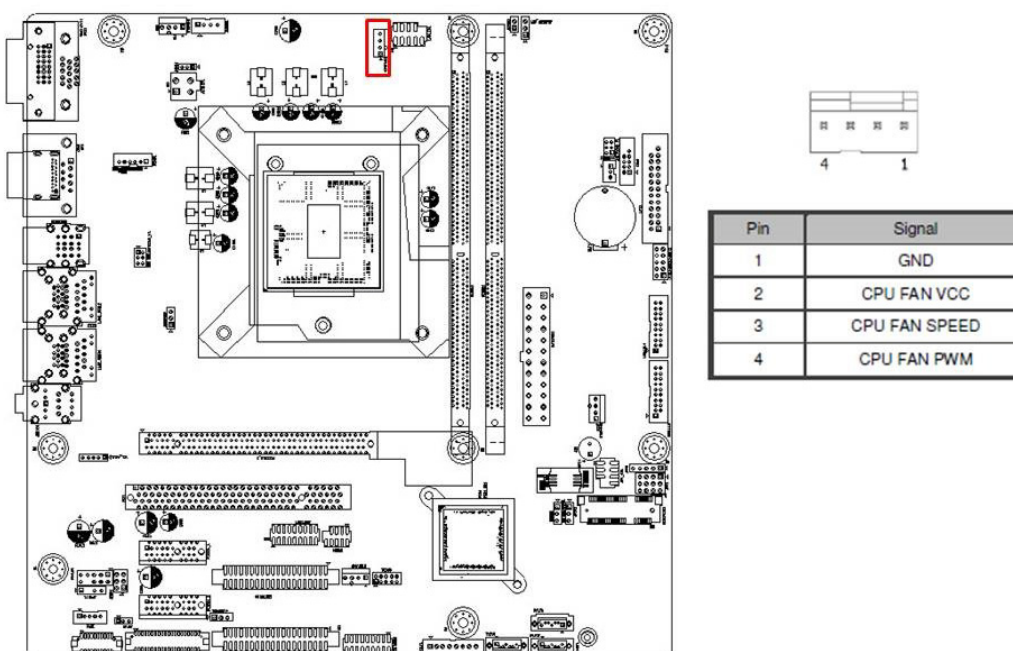

If a fan is used, this connector supports cooling fans of 500 mA (6 W) or less.

## 2.9 System FAN Connector (SYSFAN1/2/3/4)

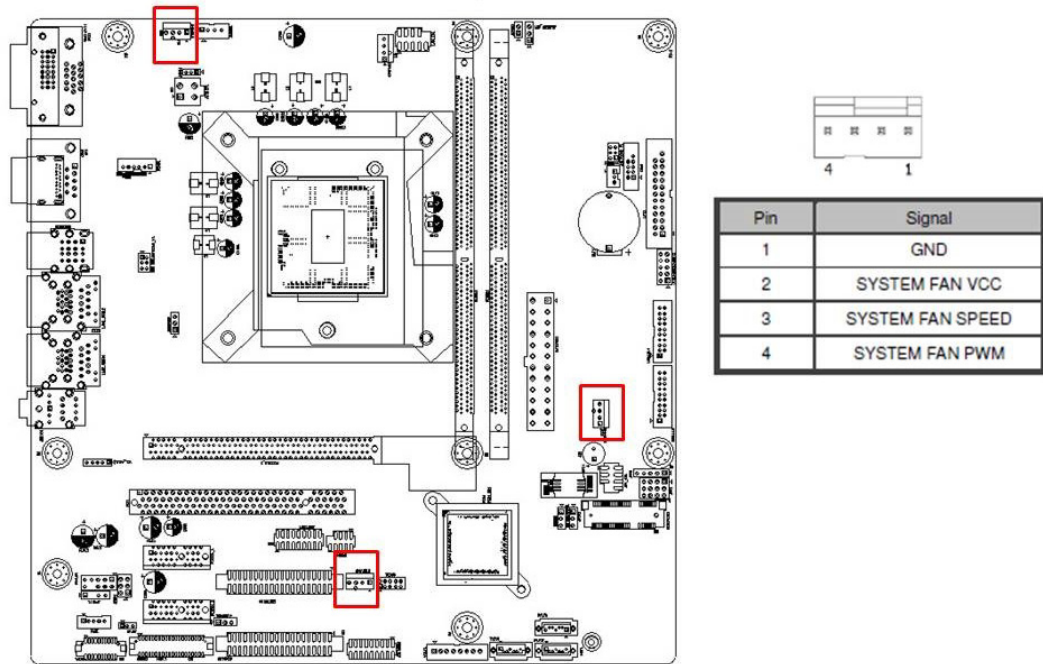

If a fan is used, this connector supports cooling fans of 500 mA (6 W) or less.



## 2.10 Front Panel Connectors (JFP1/JFP2)

There are several headers for monitoring and controlling AIMB-505.

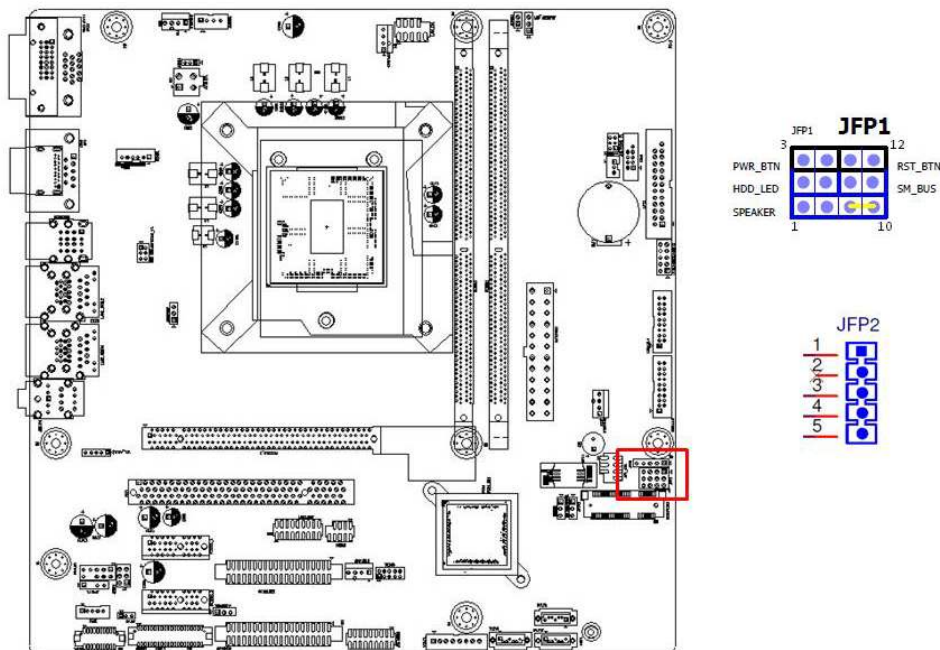

### 2.10.1 ATX soft power switch (JFP1/PWR\_SW)

If your computer case is equipped with an ATX power supply, you should connect the power on/off button on your computer case to (JFP1/ PWR\_SW), for convenient power on and off.

### 2.10.2 Reset (JFP1/RESET)

Many computer cases offer the convenience of a reset button. Connect the wire for the reset button.

### 2.10.3 HDD LED (JFP1/HDDLED)

You can connect an LED to connector (JFP1/HDDLED) to indicate when the HDD is active.

### 2.10.4 External speaker (JFP1/SPEAKER)

JFP2/SPEAKER is a 4-pin connector for an external speaker. If there is no external speaker, the AIMB-505 provides an onboard buzzer as an alternative. To enable the buzzer, set pins 7 & 10 as closed.

## 2.10.5 Power LED and keyboard lock connector (JFP2/PWR\_LED & KEY LOCK)

(JFP2/PWR\_LED & KEY LOCK) is a 5-pin connector for the power on LED and Key Lock function. Refer to Appendix B for detailed information on the pin assignments. The Power LED cable should be connected to pin 1-3. The key lock button cable should be connected to pin 4-5. There are 3 modes for the power supply connection. The first is “ATX power mode”; the system turns on/off by a momentary power button. The second is “AT Power Mode”; the system turns on/off via the power supply switch. The third is another “AT Power Mode” which makes use of the front panel power switch. The power LED status is indicated in the following table:

**Table 2.2: ATX Power Supply LED Status (No support for AT power)**

Power mode	LED (ATX Power Mode) (On/off by momentary button)	LED (AT power Mode) (On/off by switching power supply)	LED (AT power Mode) (On/off by front panel switch)
PSON1 (on back plane) jumper setting	pins 2-3 closed	pins 1-2 closed	Connect pins 1 & 2 to panel switch via cable
System On	On	On	On
System Off	Off (Windows 7) Slow Flashes (Window 8)	Off	Off
S3	Fast flashes	N/A	N/A
S4	Slow flashes	N/A	N/A

## 2.11 Line Out, Mic In Connector (AUDIO1)

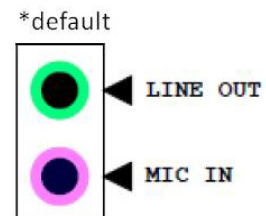
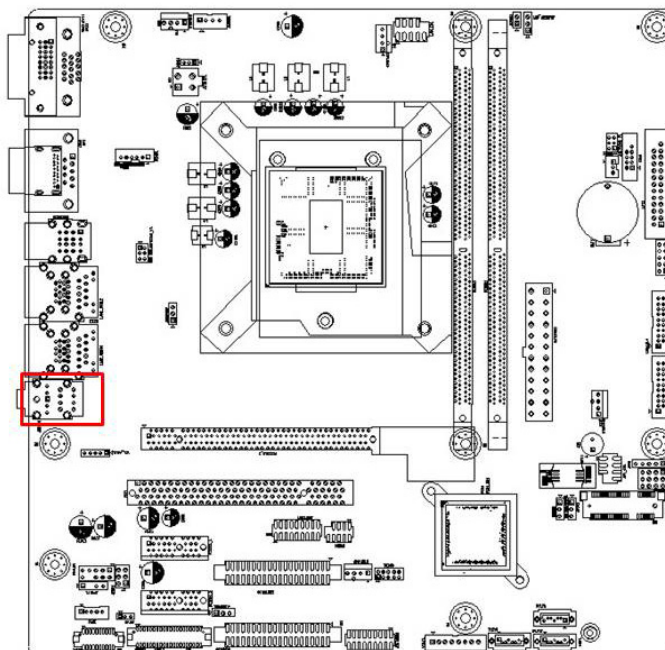

**Note!** Line out supports 6W AMP out by default.



## 2.12 Serial ATA Interface (SATA1 ~ SATA3)

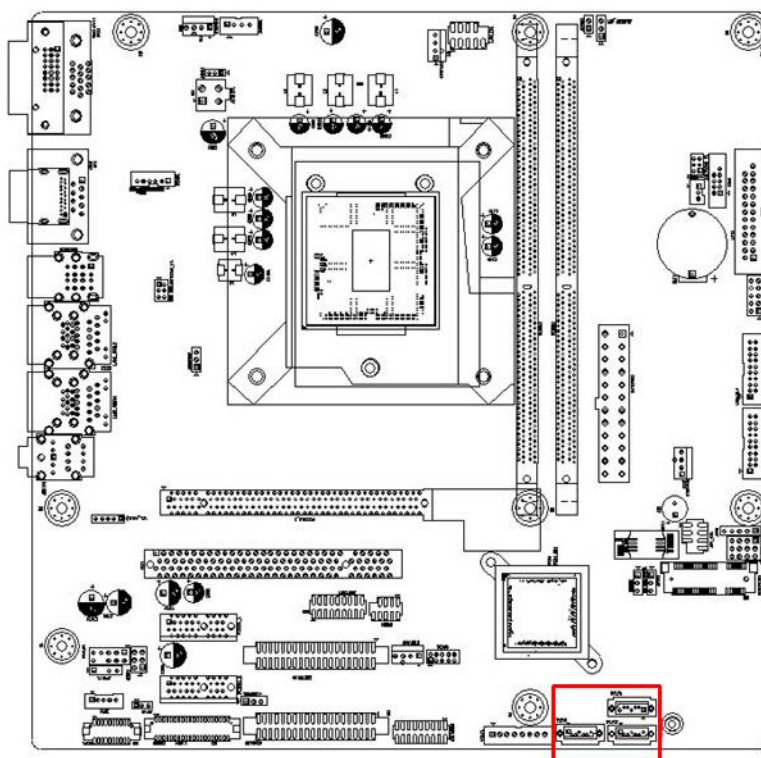

AIMB-505 features a high performance Serial ATA III interface (up to 600 MB/s) which eases hard drive cabling with thin, space-saving cables.

## 2.13 8-pin Alarm Board Connector (VOLT1)

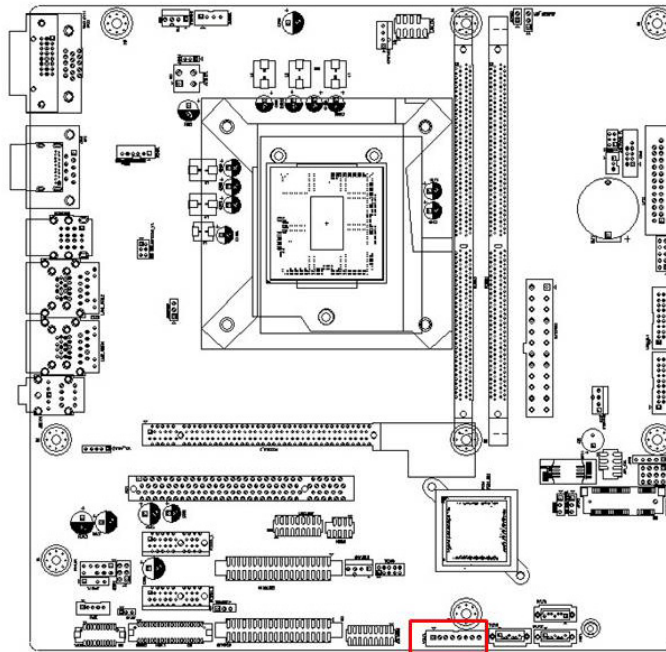

VOLT1 connects to the alarm board on the chassis. These alarm boards give warnings if a power supply or fan fails, or if the chassis overheats.

## 2.14 ATX Power Connector (EATXPWR1, ATX12V1)

This connector are for an ATX Micro-Fit power supply. The plugs from the power supply are designed to fit these connectors in only one direction. Determine the proper orientation and push down firmly until the connectors mate completely.

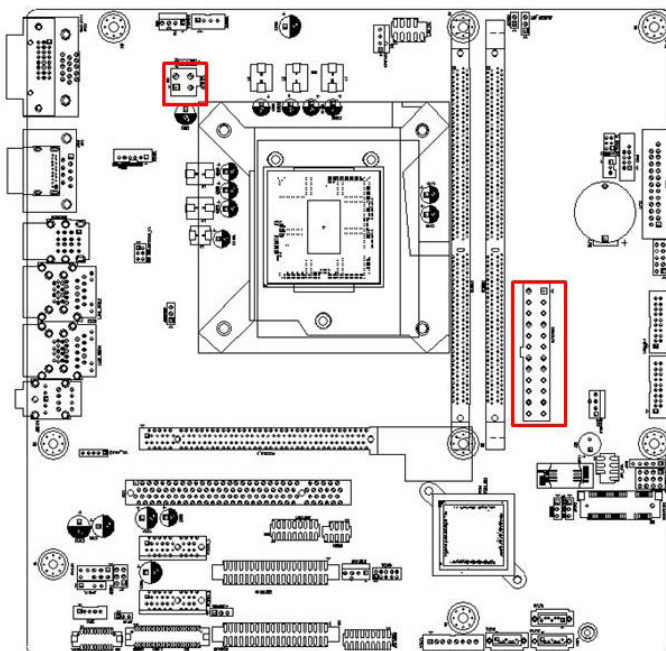

- Note!**
1. Please connect the ATX12V1 connector with the PSU ATX 12V 4-pin connector.
  2. For a fully configured system, we recommend that you use a power supply unit (PSU) that complies with ATX 12 V Specification 2.0 (or later version) and provides a minimum power of 180 W.





## 2.15 General purpose I/O Connector (GPIO1)

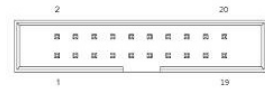
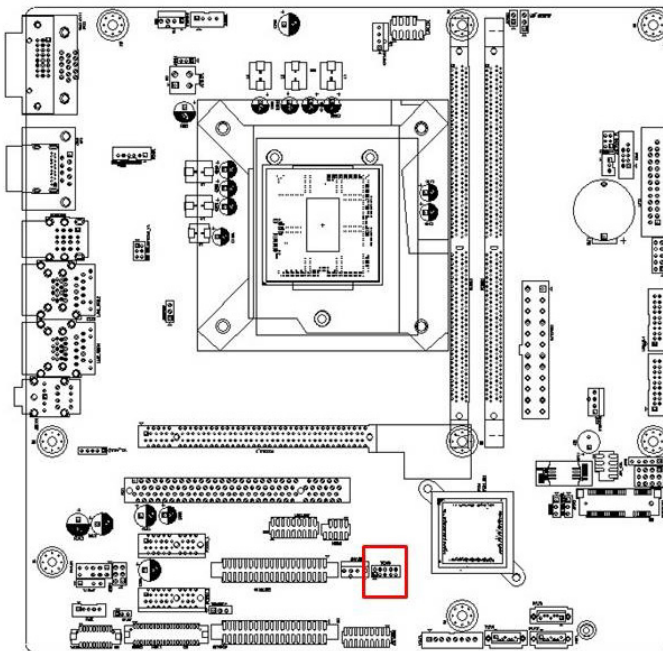

Pin	Signal	Pin	Signal
1	GPIO0	2	GPIO4
3	GPIO1	4	GPIO5
5	GPIO2	6	GPIO6
7	GPIO3	8	GPIO7
9	+V3.3_DUAL	10	GND

## 2.16 eDP/LVDS Connector (eDP1/LVDS)

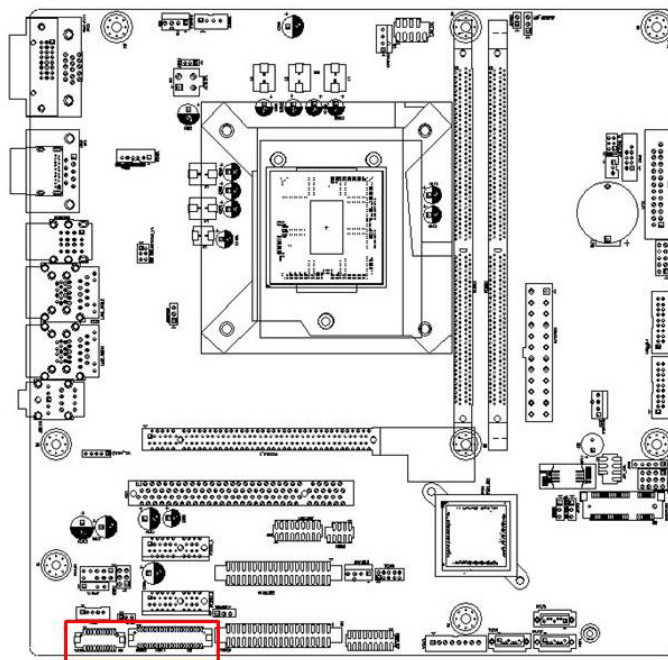

**Note!** LVDS is BOM option with eDP.  
Default is eDP.



## 2.17 EDP Backlight inverter(INV1)

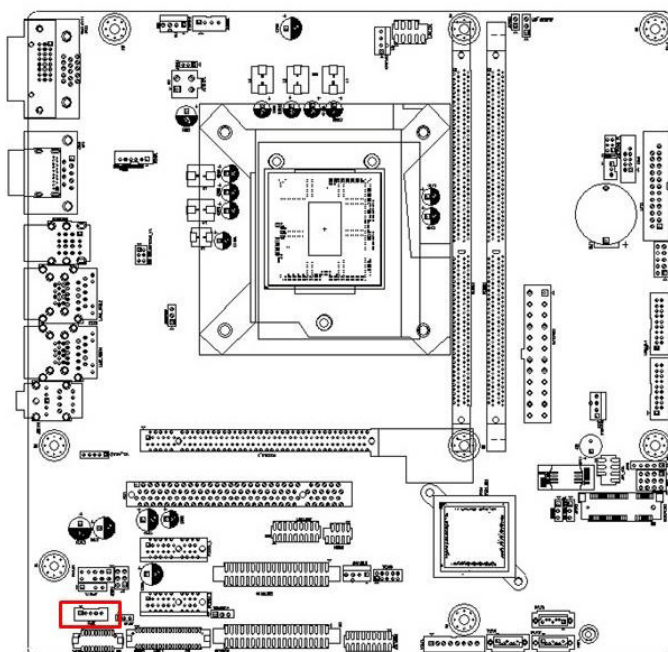

Pin	Signal
1	+12V
2	GND
3	BKL EN
4	BKL CTRL
5	+5V

## 2.18 JEDP1

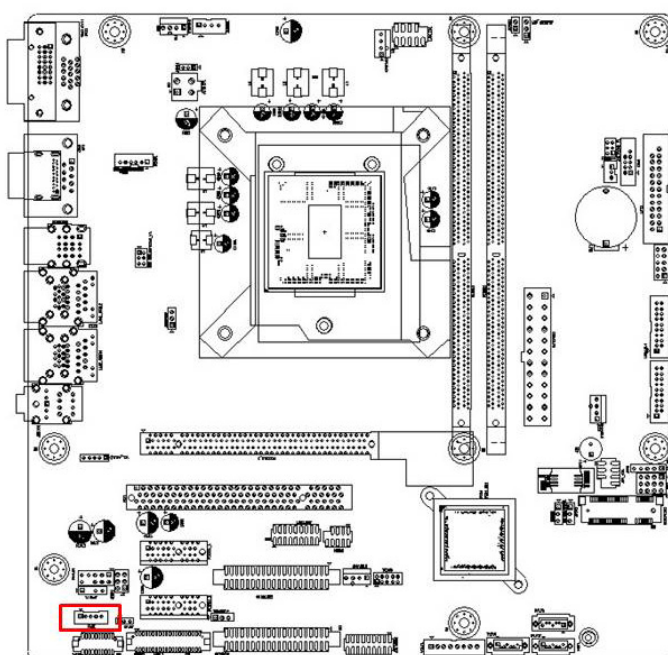

Pin	Signal												
Jumper position for +3.3V (Default)	<table border="1"> <tr> <td>2</td> <td>4</td> <td>6</td> </tr> <tr> <td><input type="radio"/></td> <td><input checked="" type="radio"/></td> <td><input type="radio"/></td> </tr> <tr> <td>1</td> <td>3</td> <td>5</td> </tr> <tr> <td><input type="radio"/></td> <td><input type="radio"/></td> <td><input type="radio"/></td> </tr> </table>	2	4	6	<input type="radio"/>	<input checked="" type="radio"/>	<input type="radio"/>	1	3	5	<input type="radio"/>	<input type="radio"/>	<input type="radio"/>
2	4	6											
<input type="radio"/>	<input checked="" type="radio"/>	<input type="radio"/>											
1	3	5											
<input type="radio"/>	<input type="radio"/>	<input type="radio"/>											
Jumper position for +5V	<table border="1"> <tr> <td>2</td> <td>4</td> <td>6</td> </tr> <tr> <td><input checked="" type="radio"/></td> <td><input type="radio"/></td> <td><input type="radio"/></td> </tr> <tr> <td>1</td> <td>3</td> <td>5</td> </tr> <tr> <td><input type="radio"/></td> <td><input type="radio"/></td> <td><input type="radio"/></td> </tr> </table>	2	4	6	<input checked="" type="radio"/>	<input type="radio"/>	<input type="radio"/>	1	3	5	<input type="radio"/>	<input type="radio"/>	<input type="radio"/>
2	4	6											
<input checked="" type="radio"/>	<input type="radio"/>	<input type="radio"/>											
1	3	5											
<input type="radio"/>	<input type="radio"/>	<input type="radio"/>											
Jumper position for +12V	<table border="1"> <tr> <td>2</td> <td>4</td> <td>6</td> </tr> <tr> <td><input type="radio"/></td> <td><input checked="" type="radio"/></td> <td><input type="radio"/></td> </tr> <tr> <td>1</td> <td>3</td> <td>5</td> </tr> <tr> <td><input type="radio"/></td> <td><input type="radio"/></td> <td><input type="radio"/></td> </tr> </table>	2	4	6	<input type="radio"/>	<input checked="" type="radio"/>	<input type="radio"/>	1	3	5	<input type="radio"/>	<input type="radio"/>	<input type="radio"/>
2	4	6											
<input type="radio"/>	<input checked="" type="radio"/>	<input type="radio"/>											
1	3	5											
<input type="radio"/>	<input type="radio"/>	<input type="radio"/>											





# Chapter 3

BIOS Operation

## 3.1 Introduction

With the AMI BIOS Setup program, you can modify BIOS settings to control the special features of your computer. The Setup program uses a number of menus for making changes. This chapter describes the basic navigation of the AIMB-505 setup screens.

## 3.2 BIOS Setup

The AIMB-505 Series system has AMI BIOS built in, with a SETUP utility that allows users to configure required settings or to activate certain system features.

The SETUP saves the configuration in the FLASH of the motherboard. When the power is turned off, the battery on the board supplies the necessary power to preserve the FLASH.

When the power is turned on, press the <Del> or <Esc> button during the BIOS POST (Power-On Self Test) to access the CMOS SETUP screen.

---

### Control Keys

---

< ← >> → >	Select Screen
< ↑ >> ↓ >	Select Item
<Enter>	Select
<+/->	Change Opt
<F1>	General help
<F2>	Previous Values
<F3>	Optimized Defaults
<F4>	Save & Exit
<Esc>	Exit

---

### 3.2.1 Main Menu

Press <Del> or <Esc> to enter AMI BIOS CMOS Setup Utility, the Main Menu will appear on the screen. Use arrow keys to select among the items and press <Enter> to accept or enter the sub-menu.



The Main BIOS setup screen has two main frames. The left frame displays all the options that can be configured. Grayed-out options cannot be configured; options in blue can. The right frame displays the key legend.

Above the key legend is an area reserved for a text message. When an option is selected in the left frame, it is highlighted in white. Often a text message will accompany it.

#### ■ System time / System date

Use this option to change the system time and date. Highlight System Time or System Date using the <Arrow> keys. Enter new values through the keyboard. Press the <Tab> key or the <Arrow> keys to move between fields. The date must be entered in MM/DD/YY format. The time must be entered in HH:MM:SS format.

### 3.2.2 Advanced BIOS Features

Select the Advanced tab from the AIMB-505 setup screen to enter the Advanced BIOS Setup screen. You can select any of the items in the left frame of the screen, such as CPU Configuration, to go to the sub menu for that item. You can display an Advanced BIOS Setup option by highlighting it using the <Arrow> keys. All Advanced BIOS Setup options are described in this section. The Advanced BIOS Setup screen is shown below. The sub menus are described on the following pages.

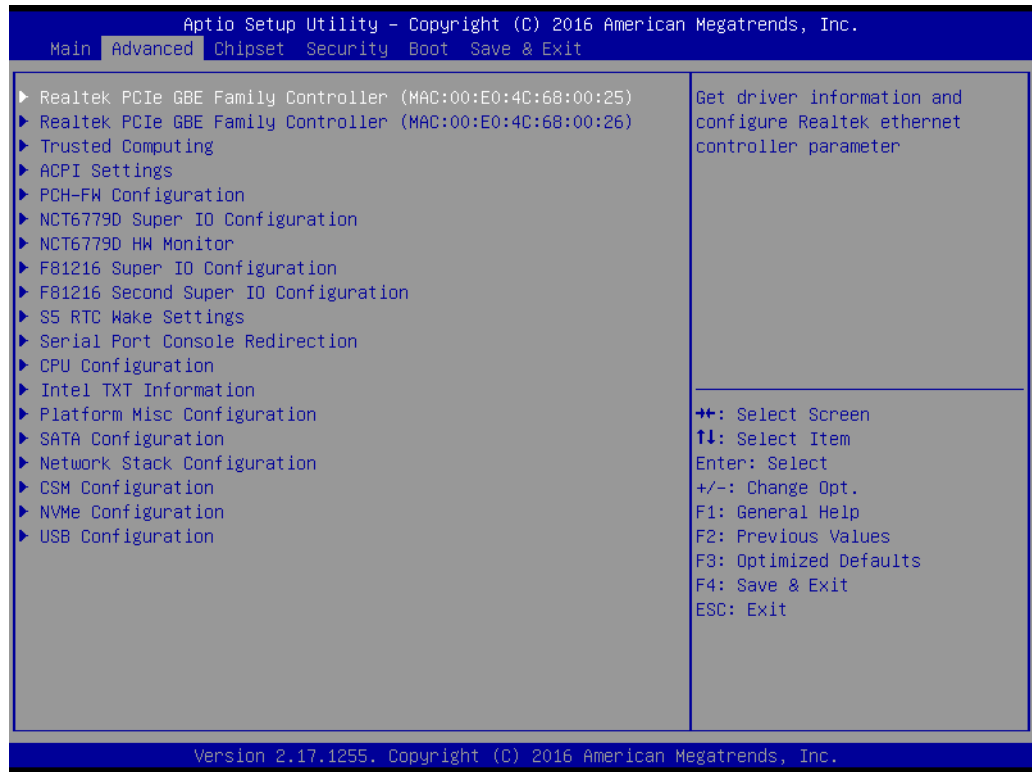

### 3.2.2.1 Trusted Computing

To enable/disable TPM (TPM 1.2/2.0) set up in BIOS. TPM (Trusted Platform Module) is a secure key generator and key cache management component, enables protected storage of encryption keys and authentication credentials for enhanced security capabilities.



#### ■ Security Device Support [ Disable ]

**Note!** TCG EFI Protocol and INT1A interface won't be available.



### 3.2.2.2 ACPI Settings

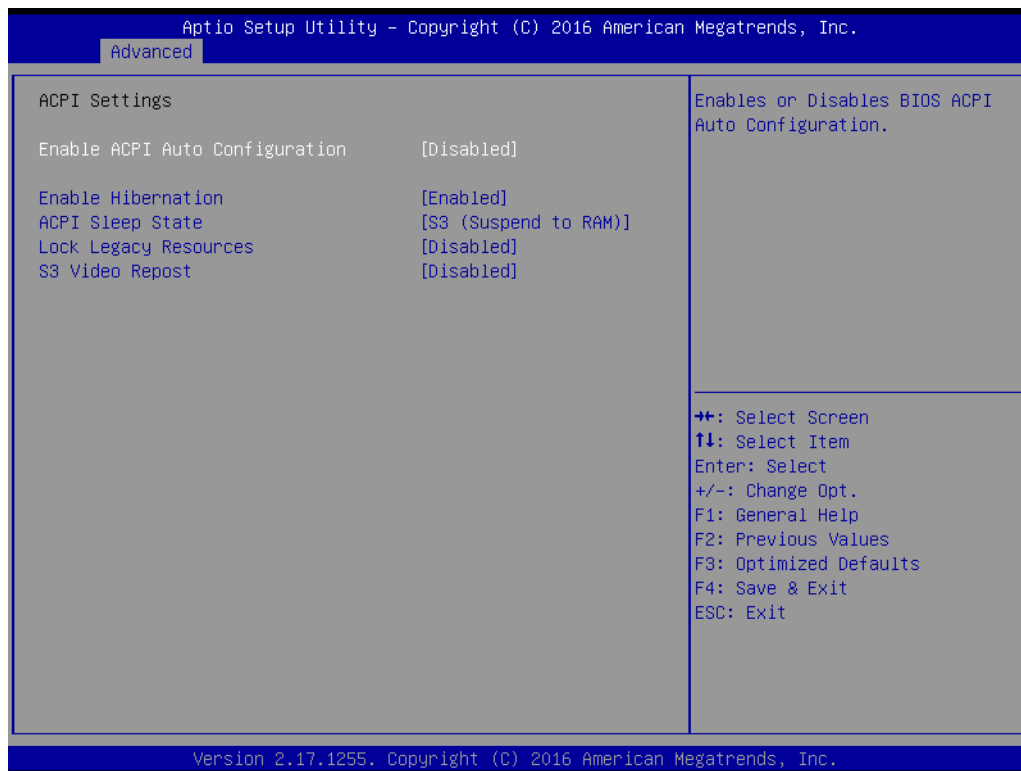

- **Enable ACPI Auto Configuration [ Disabled]**  
Enable or disable BIOS ACPI auto configuration.
- **Enable Hibernation [ Enabled ]**  
Enables or Disables System ability to Hibernate (OS/S4 Sleep State). This option may be not effective with some OS.
- **ACPI Sleep State [ Auto ]**  
Select ACPI sleep state the system will enter when the SUSPEND button is pressed.
- **Lock Legacy Resources [ Disabled ]**  
Enables or Disables Lock of Legacy Resources.
- **S3 Video Repost [ Disabled ]**  
Enable or Disable S3 Video Repost.

### 3.2.2.3 AMT Configuration

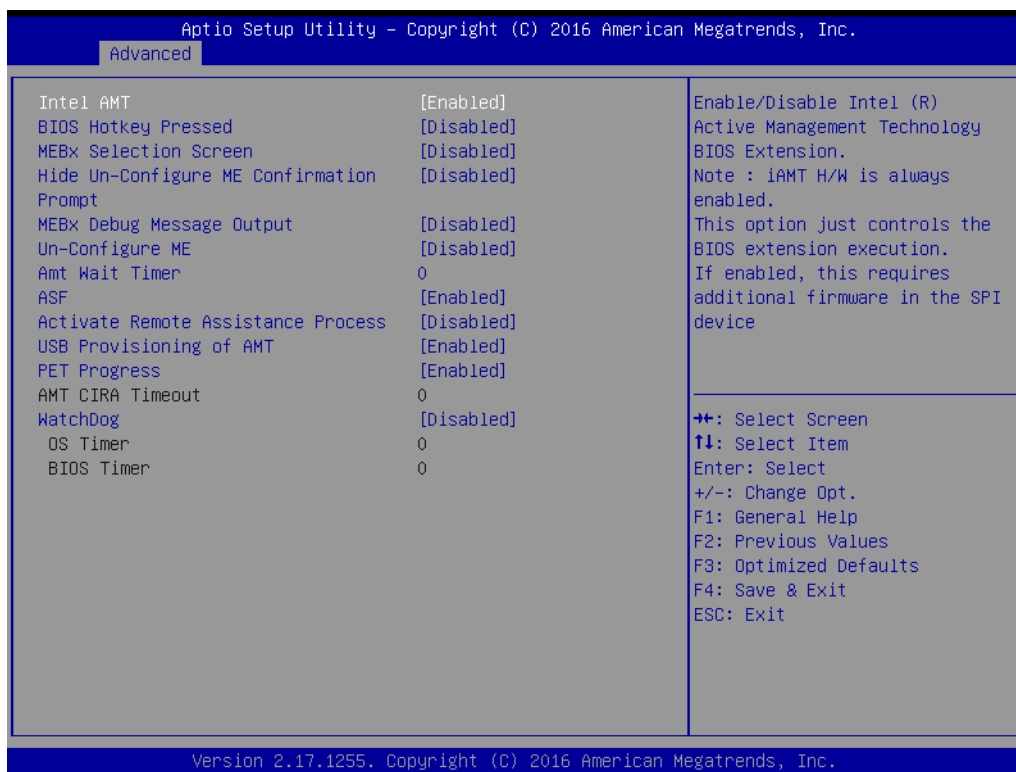

- **Intel AMT [ Enabled ]**  
This item allows users to enable or disable Intel AMT BIOS extension.
- **BIOS Hotkey Pressed [ Disabled ]**  
Enable/Disable BIOS hotkey press.
- **MEBx Select Screen [ Disabled ]**  
Enable/Disable MEBx selection screen.
- **Hide Un-Configure ME Confirmation [ Disabled ]**  
Hide Un-Configure ME without password Confirmation Prompt.
- **MEBx Debug Message Output [ Disabled ]**  
Enable MEBx debug message output.
- **Un-Configure ME [ Disabled ]**  
Sets this item to [Disabled] to unconfigure AMT/ME without using a password or set it as [Enabled] to use a password.
- **Amt Wait timer [0]**  
Set timer to wait before sending ASF\_GET\_BOOT\_OPTIONS.
- **Disable ME [ Disabled ]**  
Set ME to Soft Temporary Disabled.
- **ASF [ Enabled ]**  
Enable/Disable Alert Specification Format.
- **Active Remote Assistance Process [ Disabled ]**  
Trigger CIRA boot.
- **USB Configure [ Enable ]**  
Enable/Disable USB Configure function.
- **PET Progress [ Enable ]**  
User can Enable/Disable PET Events progress to receive PET events or not.

---

- **AMT CIRA Timeout [ 0 ]**

OEM defined timeout for MPS connection to be established.

- **Watchdog [ Disabled ]**

When set to [Enabled], the Watchdog timer will monitor the time taken for each task performed by a software or hardware.

- **OS Timer [ 0 ]**

- Set OS watchdog timer.

- **BIOS Timer [ 0 ]**

- Set BIOS watchdog timer



### 3.2.2.4 PCH FM Configuration



#### ■ Firmware update Configuration

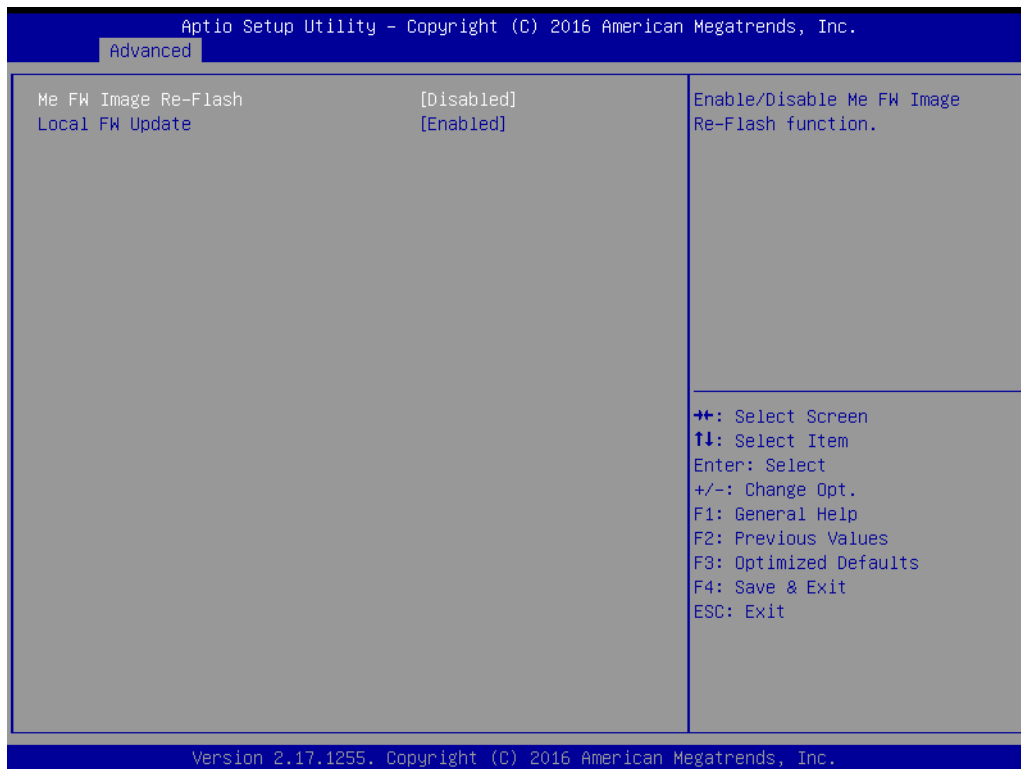

- ME FW Image Re-Flash [Disabled]
- Local FW Update [Enabled]

### 3.2.2.5 NCT6779D Super IO Configuration

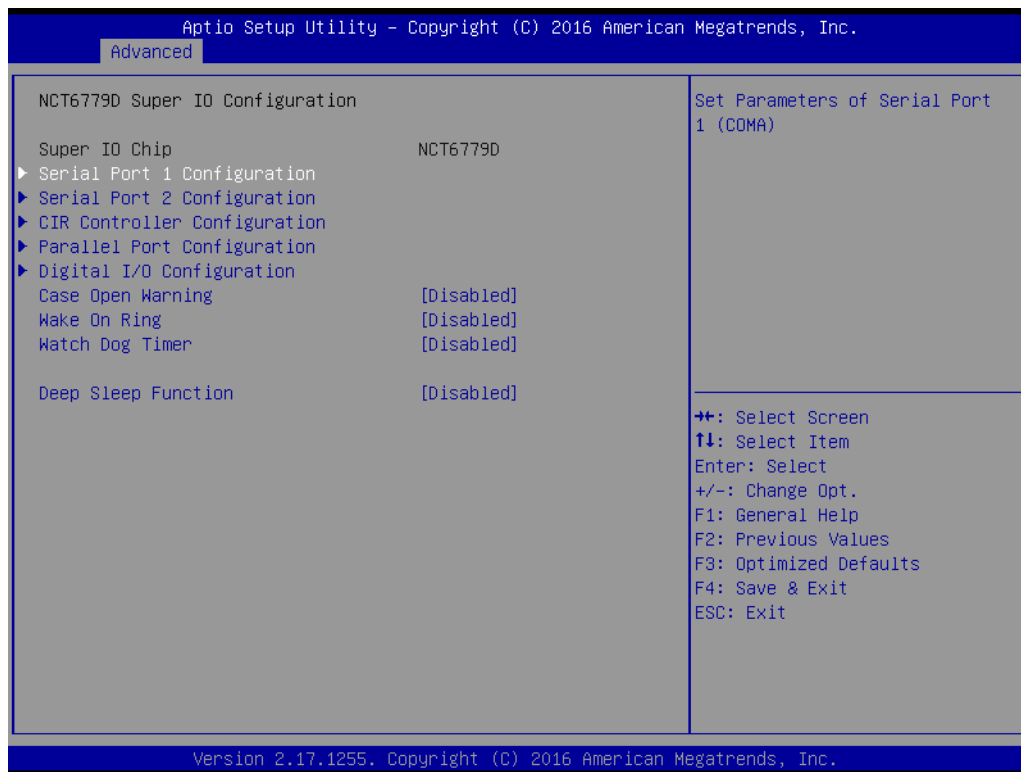

- Super IO Chip [NCT6779D]
- Serial Port 1 Configuration

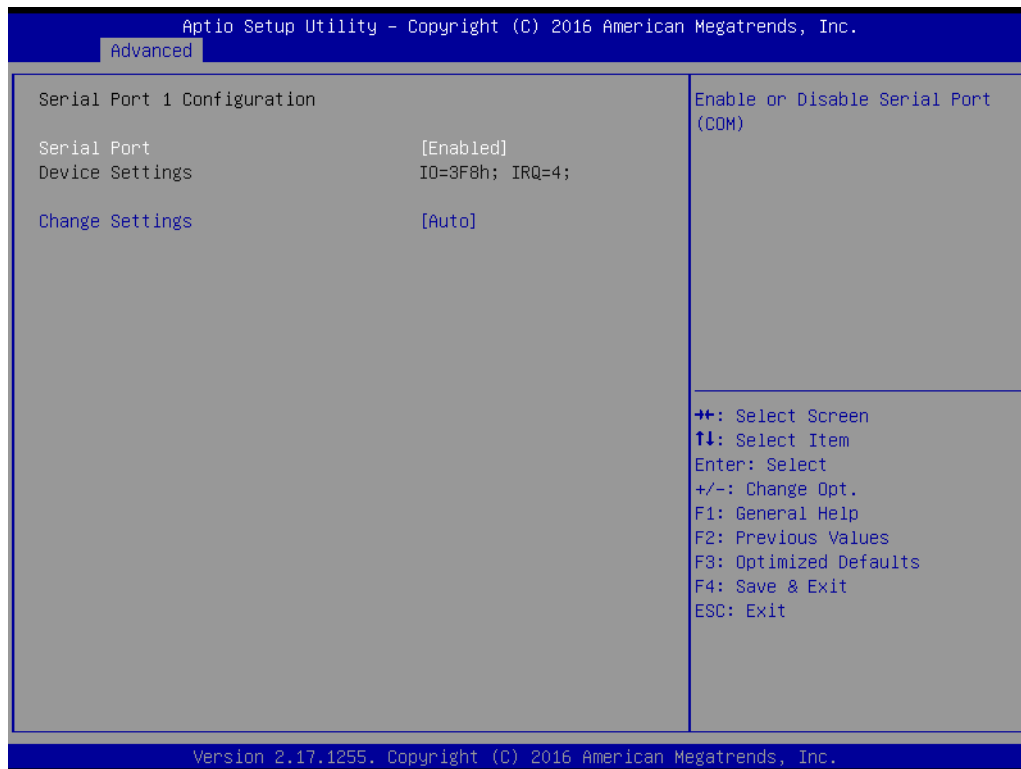

- **Serial Port [ Enabled ]**
- **Device Settings: IO=3F8h; IRQ =4**
- **Change Settings [ Auto ]**  
To select an optimal setting for serial port 1.

#### ■ Serial Port 2 Configuration

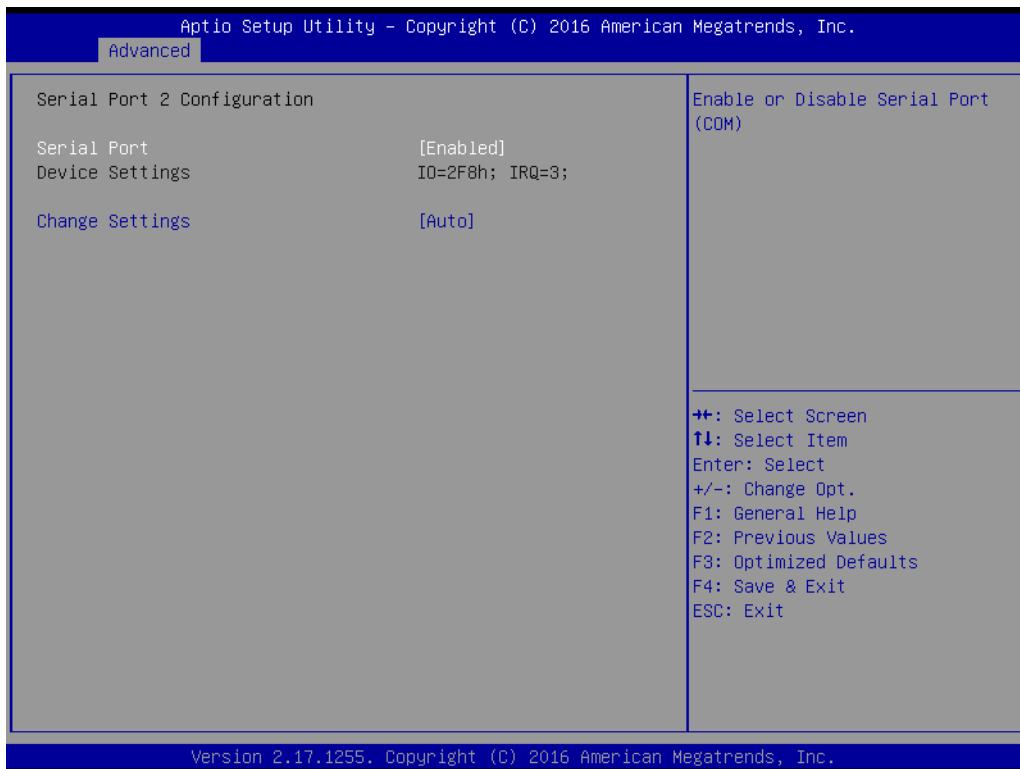

- **Serial Port [ Enabled ]**
- **Device Settings: IO=2F8h; IRQ =3**
- **Change Setting [ Auto ]**  
To select an optimal setting for serial port 2.

### 3.2.2.6 NCT6776D Configuration

#### ■ PC Health Status

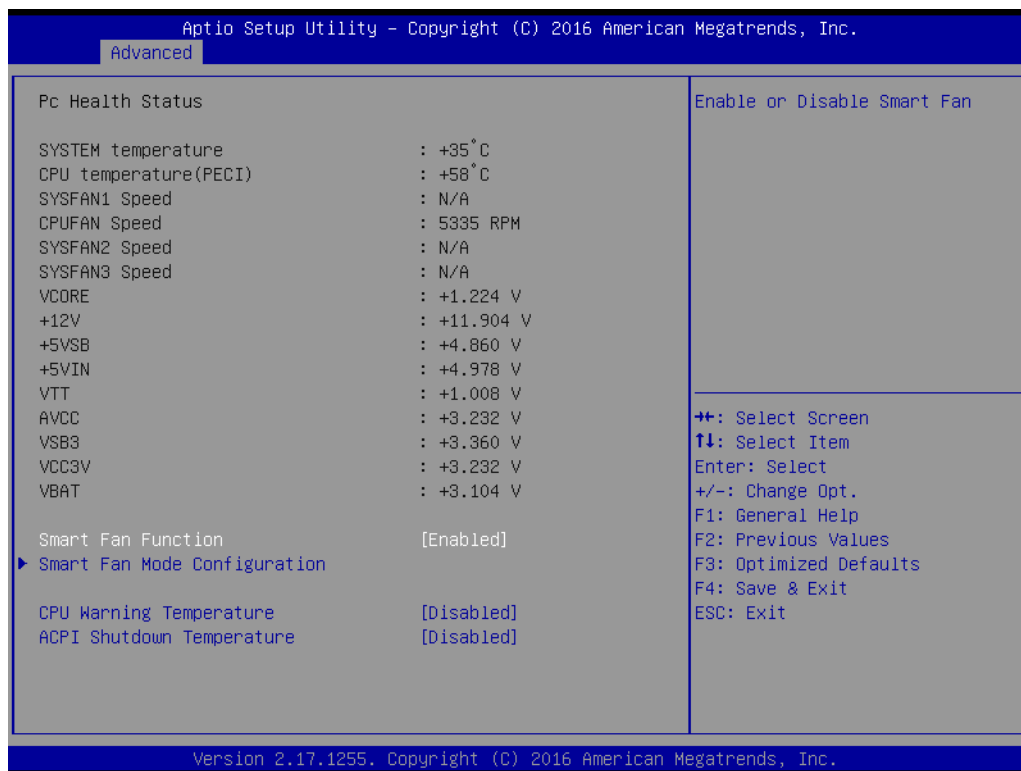

#### – CPU Warning Temperature [ Disabled ]

Use this to set the CPU warning temperature threshold. When the system reaches the warning temperature, the speaker will beep.

#### – ACPI Shutdown Temperature [ Disabled ]

Use this to set the ACPI shutdown temperature threshold. When the system reaches the shutdown temperature, it will be automatically shut down by ACPI OS to protect the system from overheating damage.

## ■ Smart Fan Mode Configuration

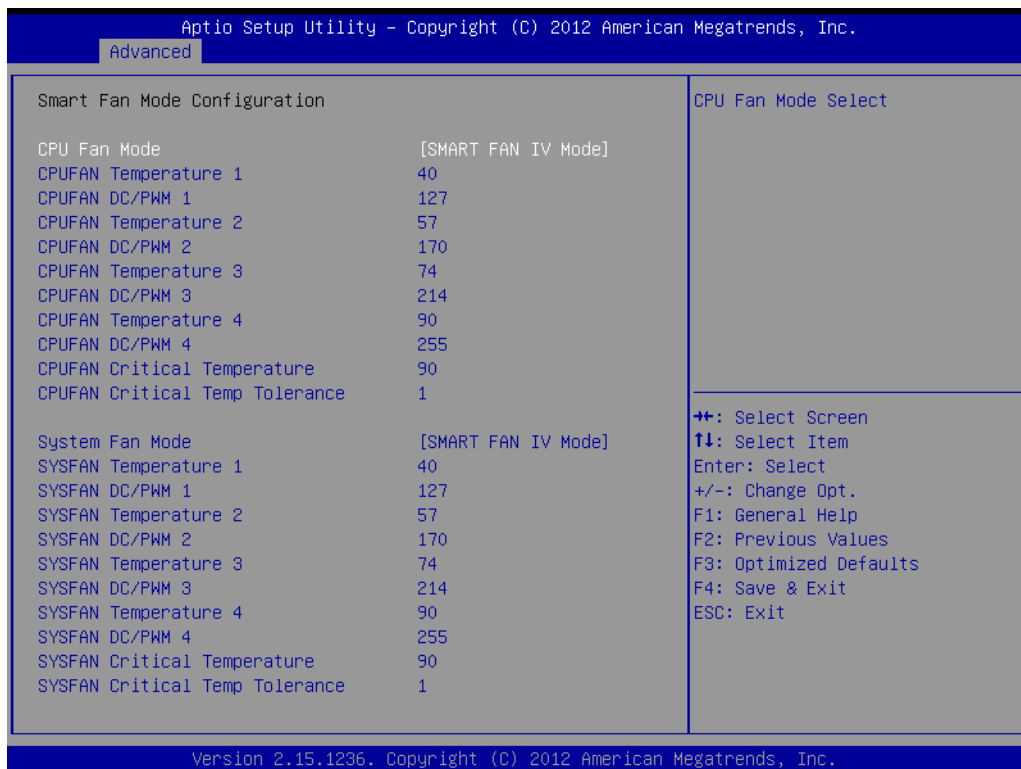

### ■ CPU FAN Mode [ SMART FAN IV Mode ]

The item shows you CPU temperature and fan speed (PWM) information.

### ■ SYSFAN Mode [ SMART FAN IV Mode ]

The item shows you system temperature and fan speed (PWM) information.

## ■ Digital I/O Configuration

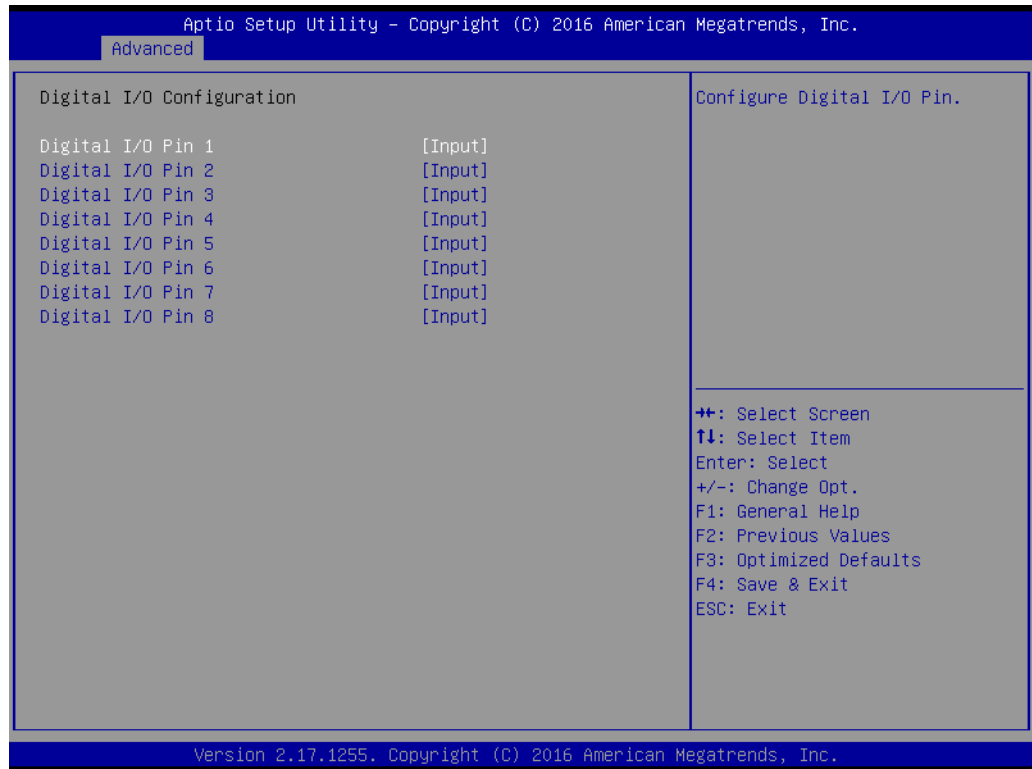

– Digital I/O Pin 1 - 8 [Input]

### 3.2.2.7 F81216 Super IO configuration

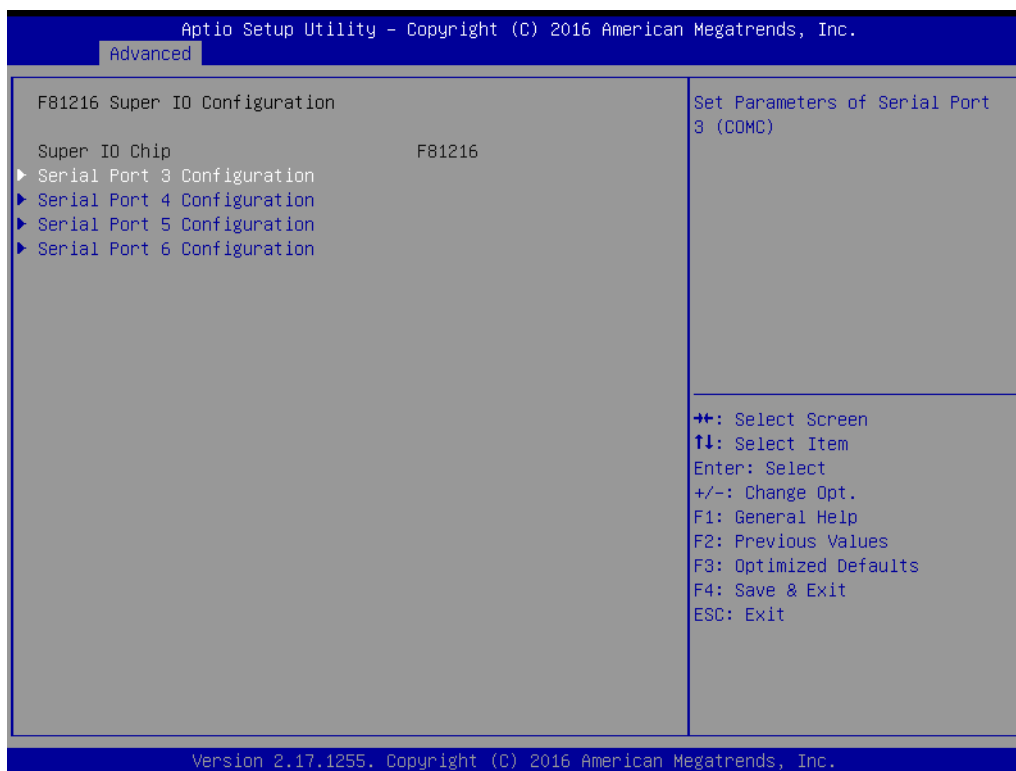

#### ■ Serial Port 3 Configuration

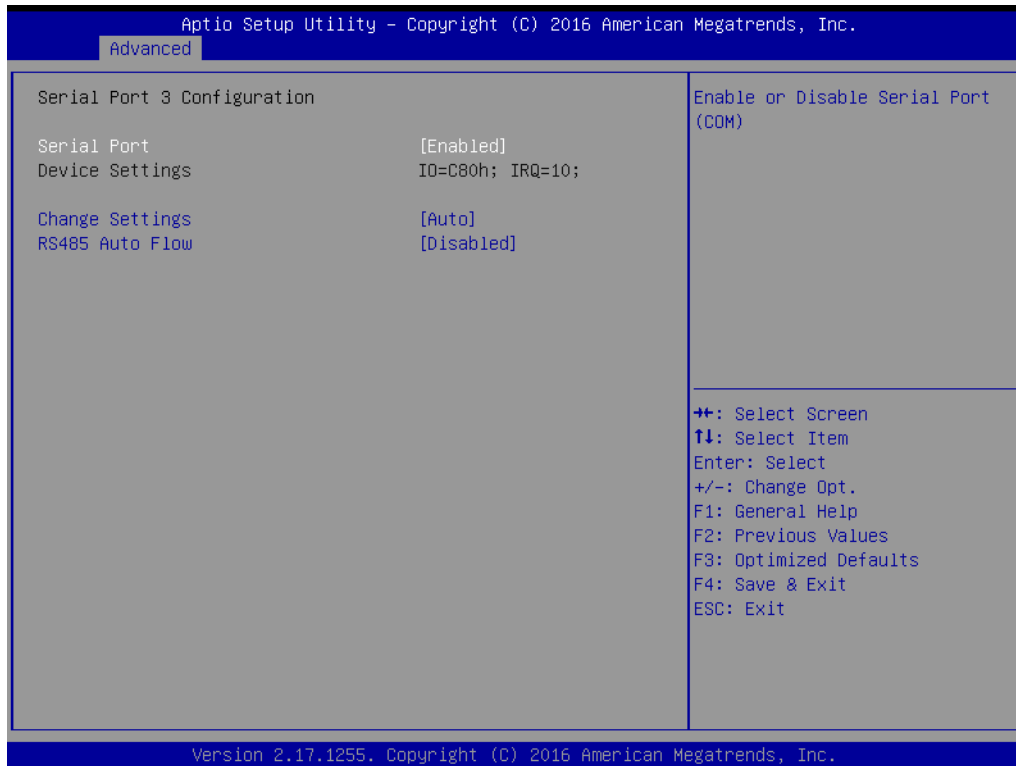

- **Serial Port [Enabled]**  
To “enable or disable” serial port 3.
- **Device Settings: IO=C80h; IRQ =10**
- **Change Setting [Auto]**
- **RS486 Auto Flow [Disabled]**  
To select an optimal setting for serial port 3.

■ **Serial Port 4 Configuration**

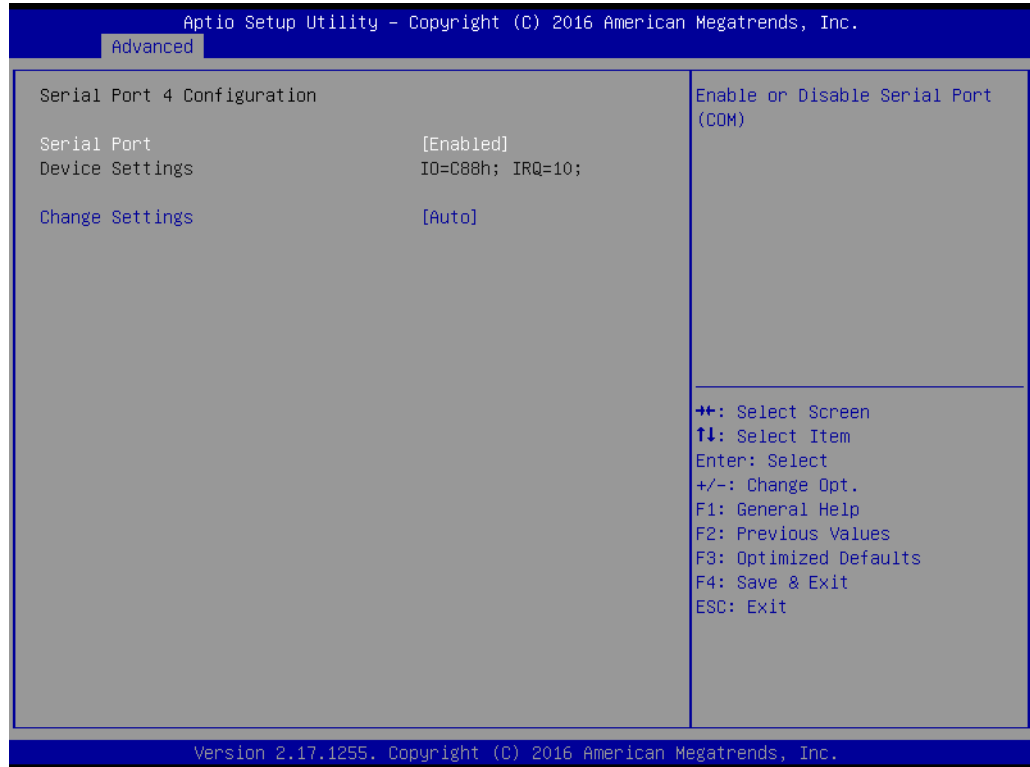

- **Serial Port [Enabled]**  
To “enable or disable” serial port 4.
- **Device Settings: IO=C88h; IRQ =10**
- **Change Setting [Auto]**  
To select an optimal setting for serial port 4.



## ■ Serial Port 5 Configuration

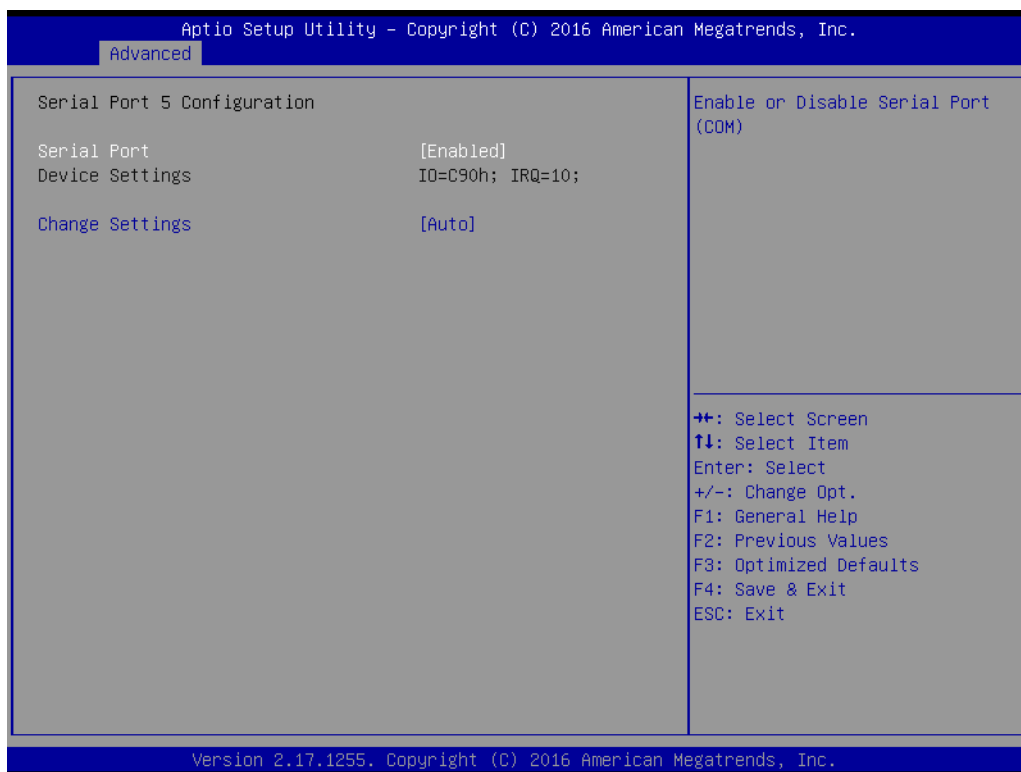

- **Serial Port [Enabled]**  
To “enable or disable” serial port 4.
- **Device Settings: IO=C90h; IRQ =10**
- **Change Setting [Auto]**  
To select an optimal setting for serial port 5.

## ■ Serial Port 6 Configuration

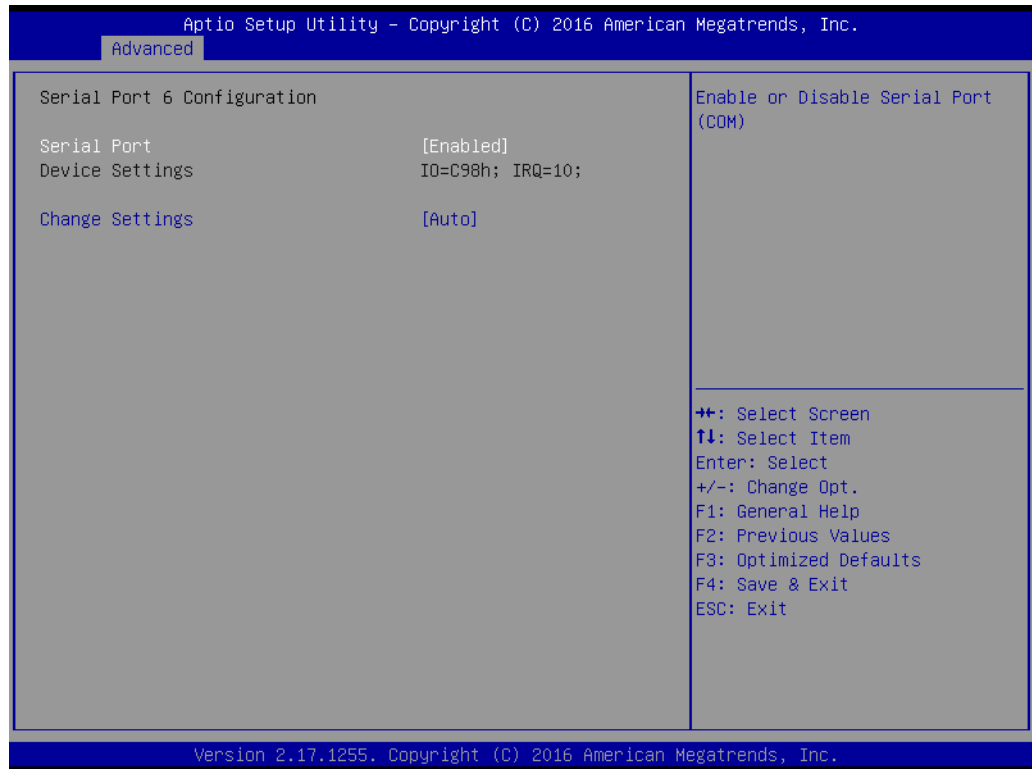

- **Serial Port [Enabled]**  
To "enable or disable" serial port 4.
- **Device Settings: IO=C98h; IRQ =10**
- **Change Setting [Auto]**  
To select an optimal setting for serial port 6.

### 3.2.2.8 F81216 scend Super IO configuration



#### ■ Serial Port 7 Configuration

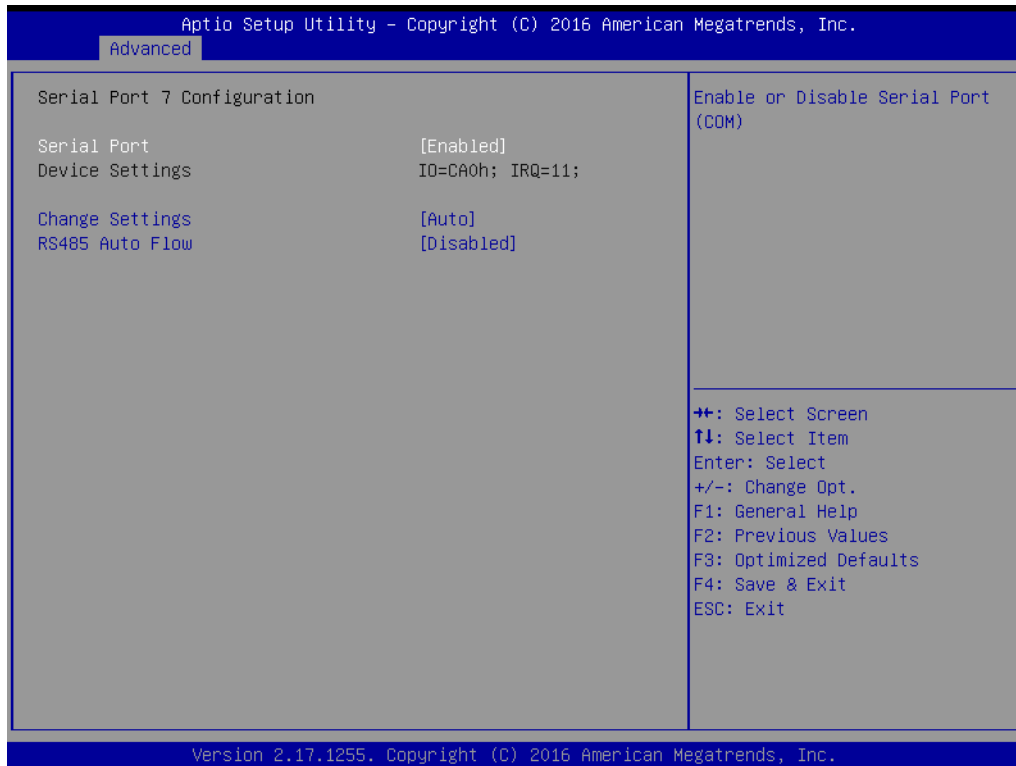

- **Serial Port [Enabled]**  
To “enable or disable” serial port 4.
- **Device Settings: IO=CA0h; IRQ =11**

- **Change Setting [Auto]**  
To select an optimal setting for serial port 7.

■ **Serial Port 8 Configuration**

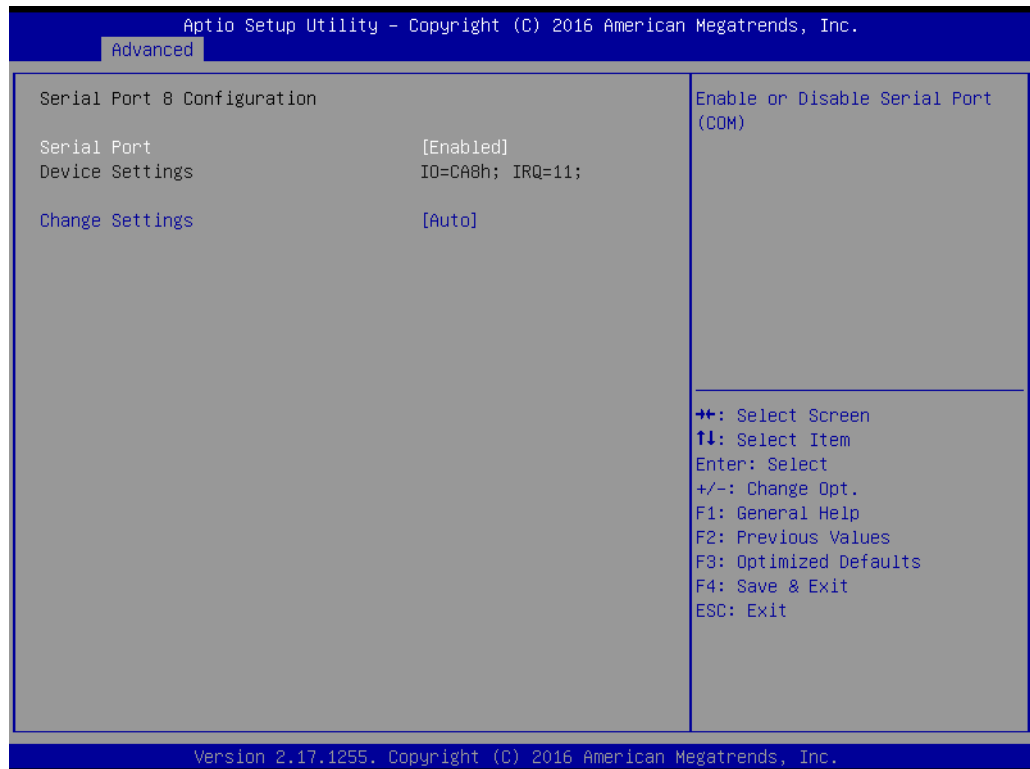

- **Serial Port [Enabled]**  
To “enable or disable” serial port 4.
- **Device Settings: IO=CA8h; IRQ =11**
- **Change Setting [Auto]**  
To select an optimal setting for serial port 8.

## ■ Serial Port 9 Configuration

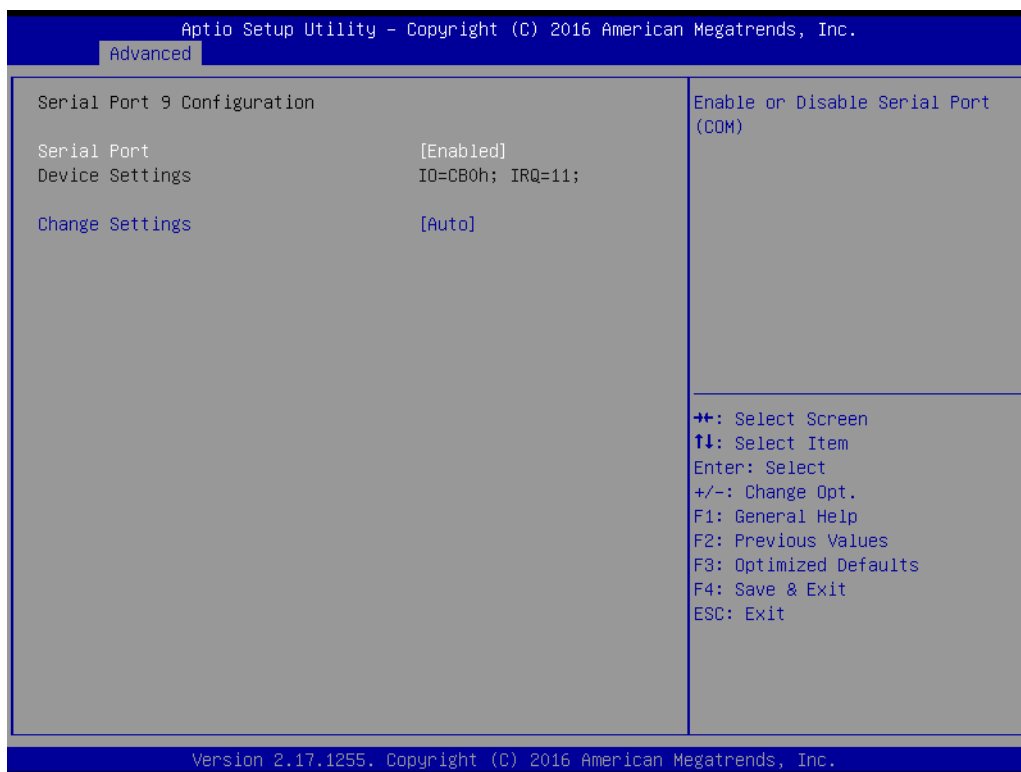

- **Serial Port [Enabled]**  
To “enable or disable” serial port 4.
- **Device Settings: IO=C80h; IRQ =11**
- **Change Setting [Auto]**  
To select an optimal setting for serial port 9.

## ■ Serial Port 10 Configuration



- **Serial Port [Enabled]**  
To “enable or disable” serial port 4.
- **Device Settings: IO=C88h; IRQ =11**
- **Change Setting [Auto]**  
To select an optimal setting for serial port 10.

### 3.2.2.9 Serial Port Console Redirection

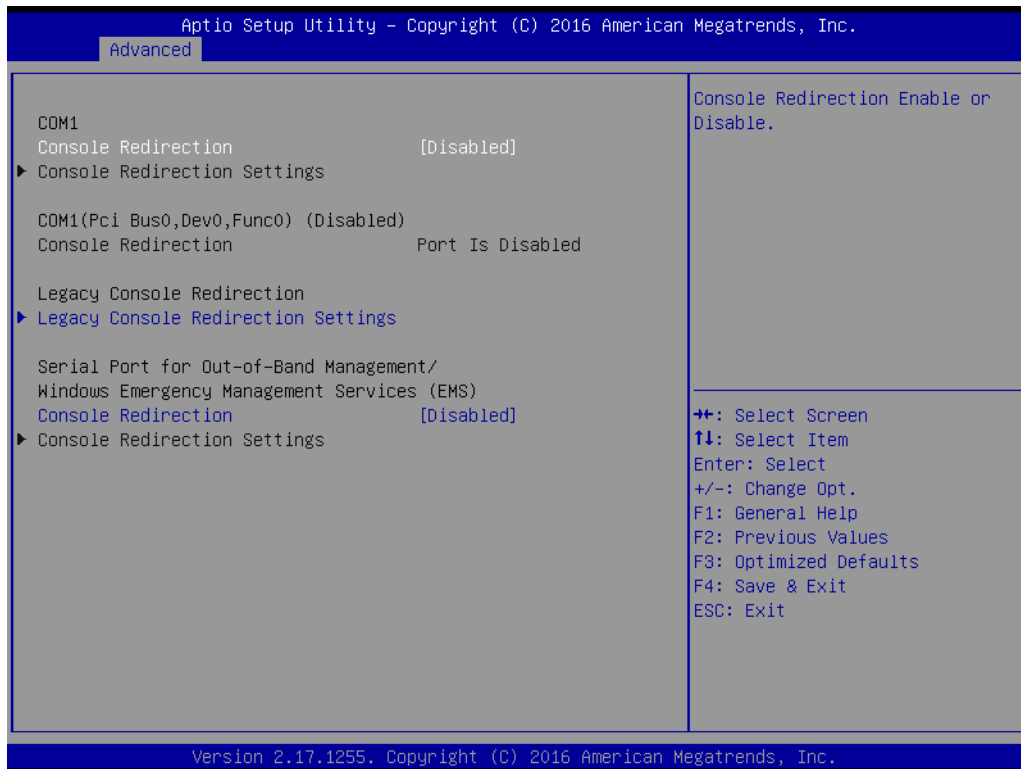

- **Console Redirection [Disabled]**  
Enable or disable the console redirection feature

### 3.2.2.10 CPU Configuration

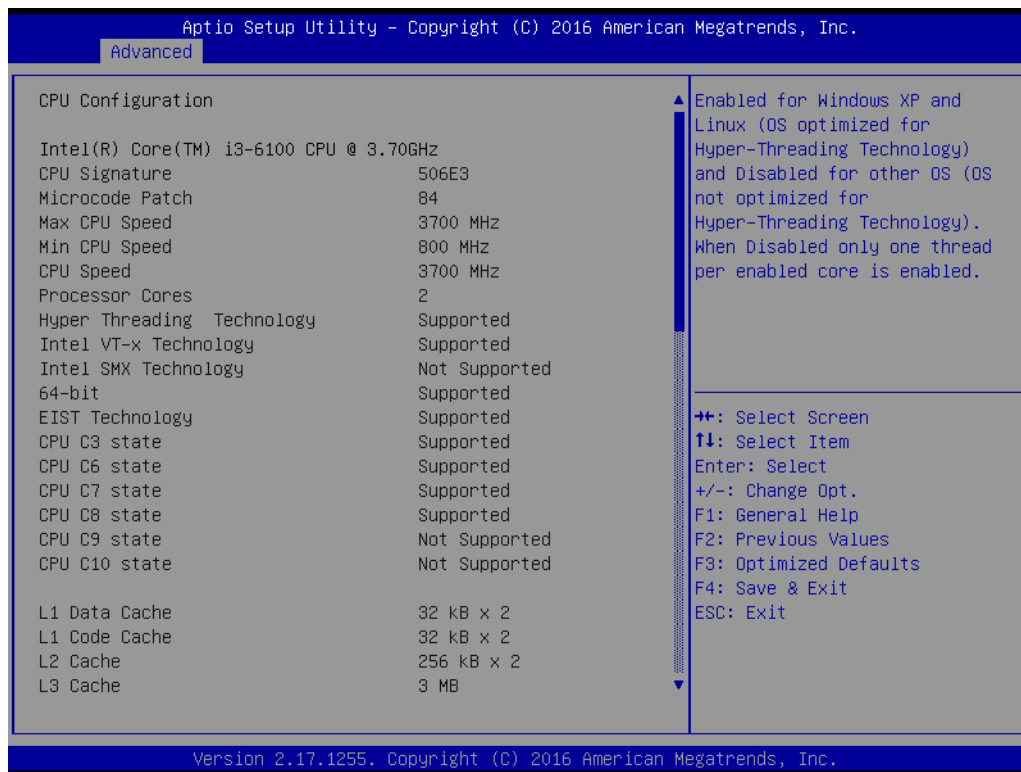

#### ■ CPU Configuration

The item shows you CPU specification and feature, the content would be different for different CPU.

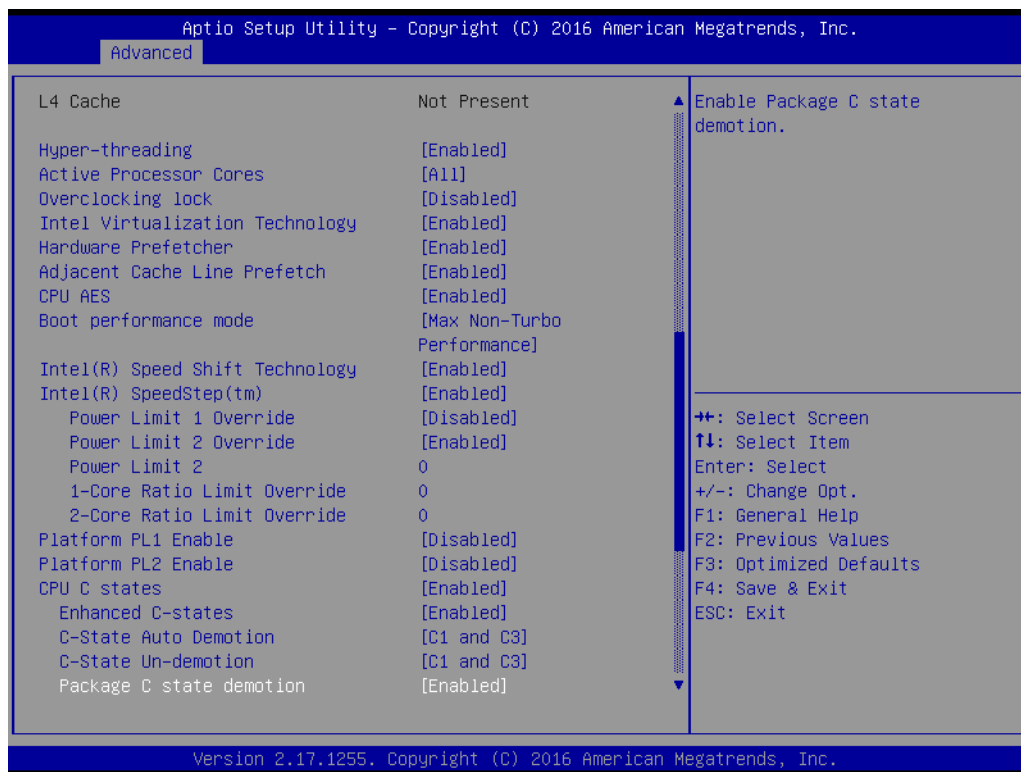



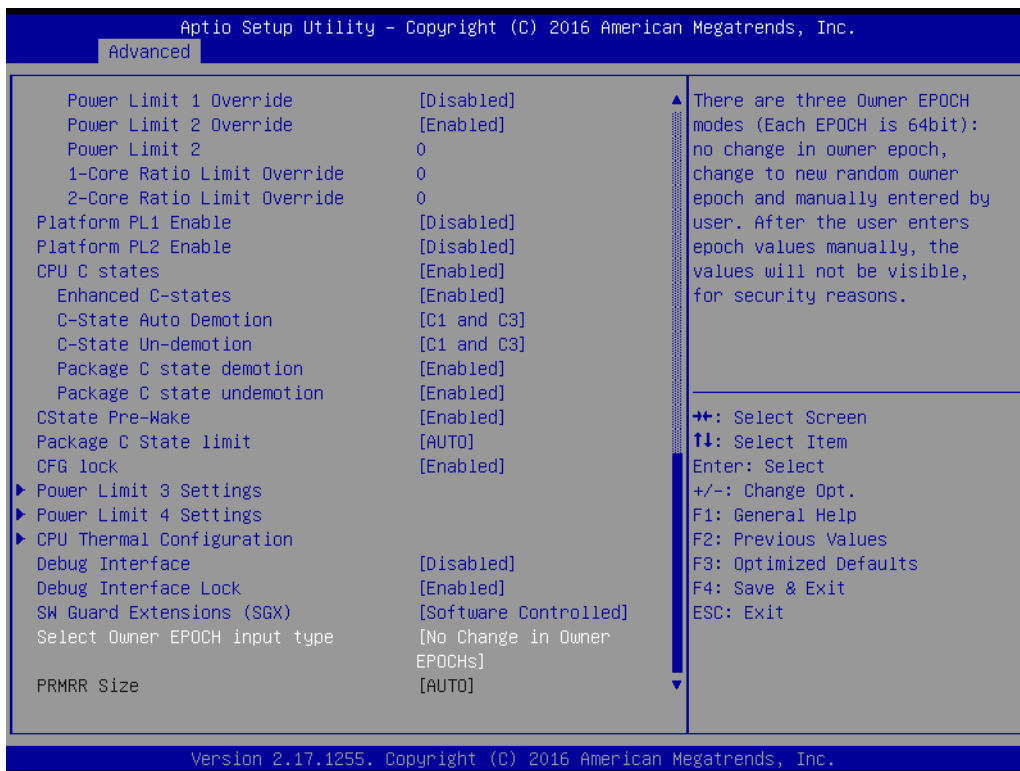

### 3.2.2.11 SATA Configuration

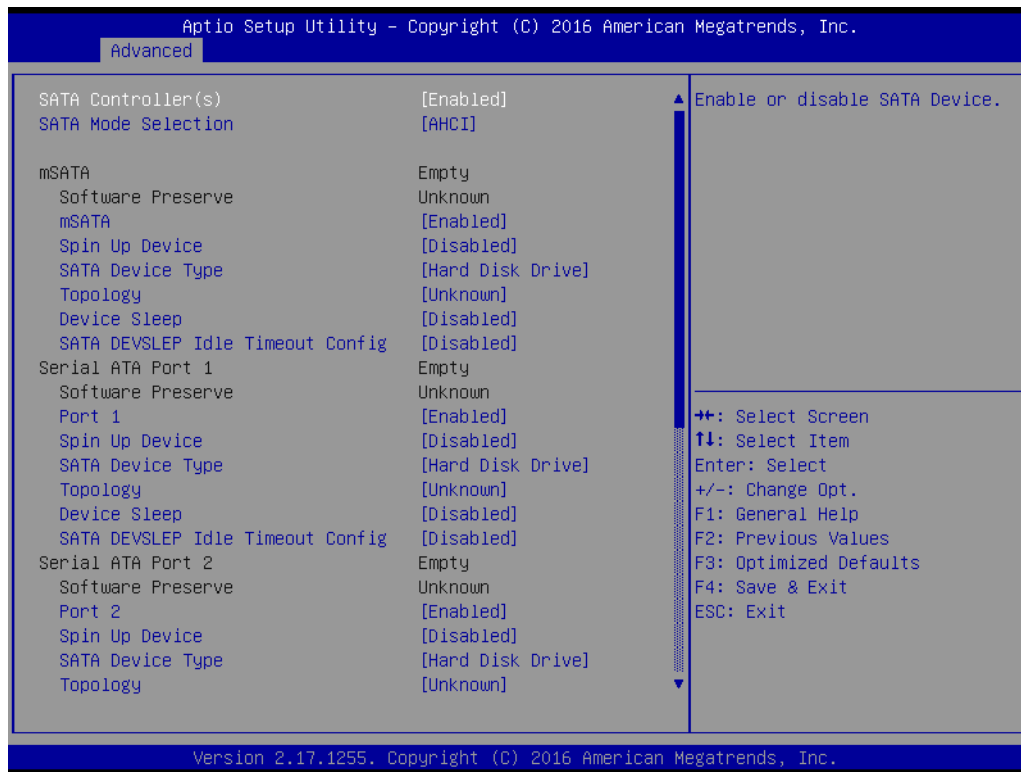

- **SATA Controllers [ Enabled ]**  
Enable or disable SATA Function.
- **SATA Mode [ AHCI ]**  
This can be configured as IDE, AHCI or RAID mode.

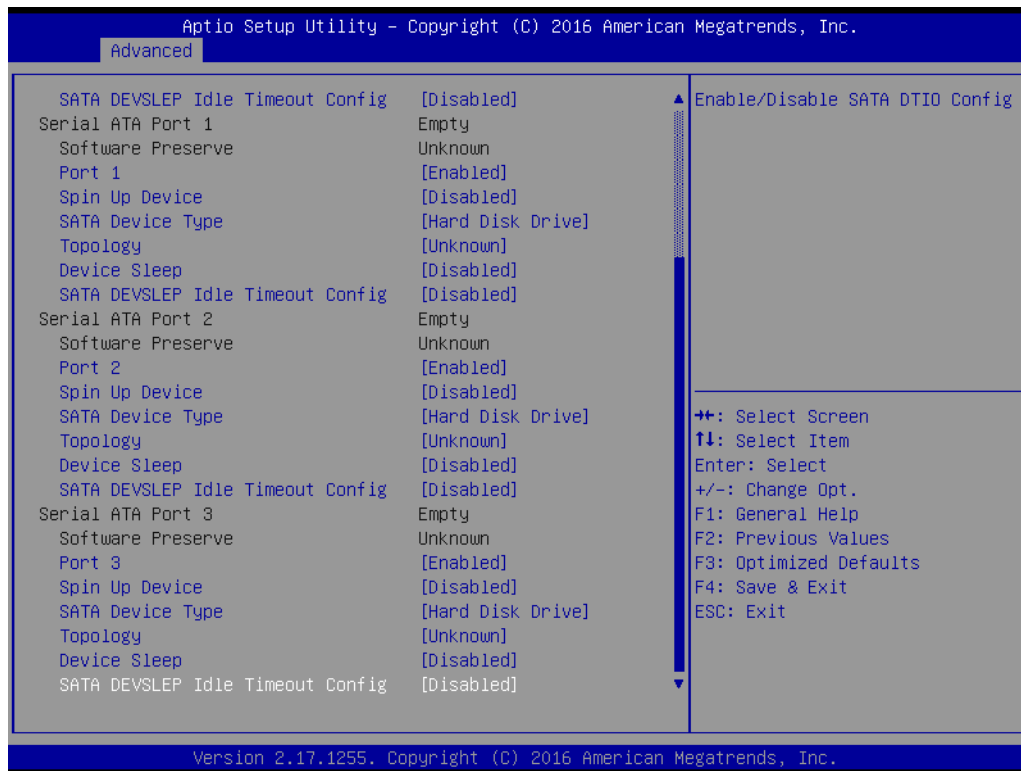

### 3.2.2.12 CSM Configuration

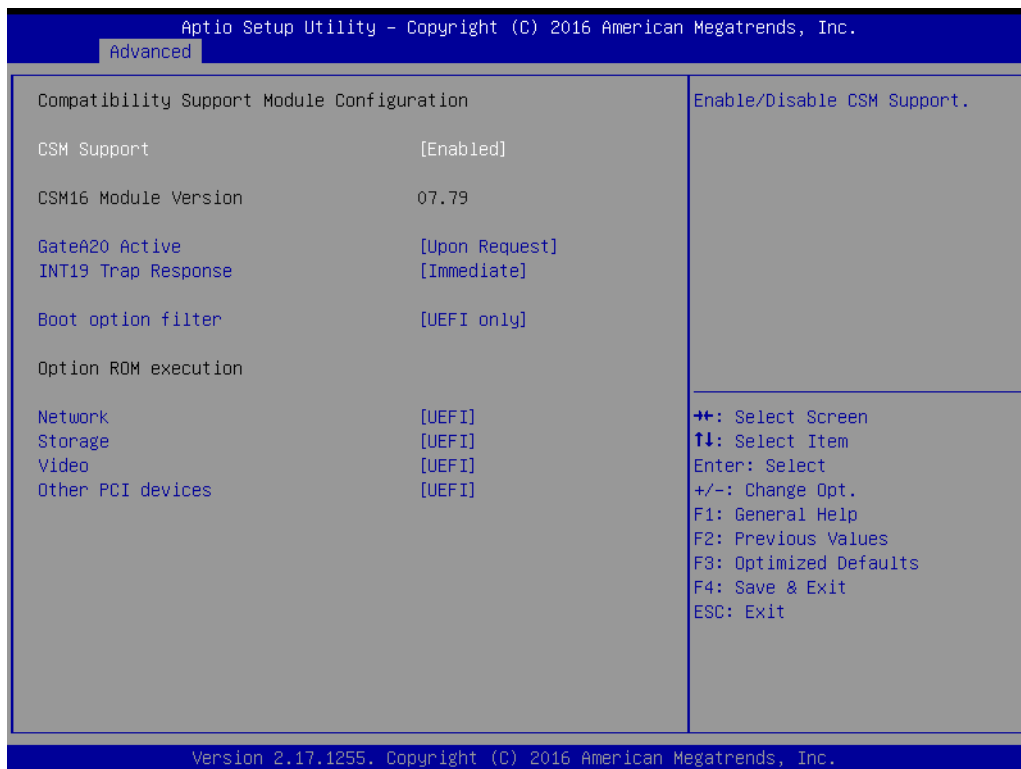

- **Boot option filter** [UEFI only]
- **Network** [UEFI]
- **Storage** [UEFI]
- **Video** [UEFI]
- **Other PCI device** [UEFI]

**Note!** *If your HDD or other boot device is installed as Legacy mode, it may cause blue screen situation. There are 2 ways to solve this:*



1. *Re-install your OS as UEFI Mode*
2. *Change all of settings above as " Legacy"*
  - \* *Boot option filter-> Legacy Only*
  - \* *Network -> Legacy*
  - \* *Storage -> Legacy*
  - \* *Video -> Legacy*
  - \* *Other PCI devices -> Legacy*

### 3.2.2.13 USB Configuration

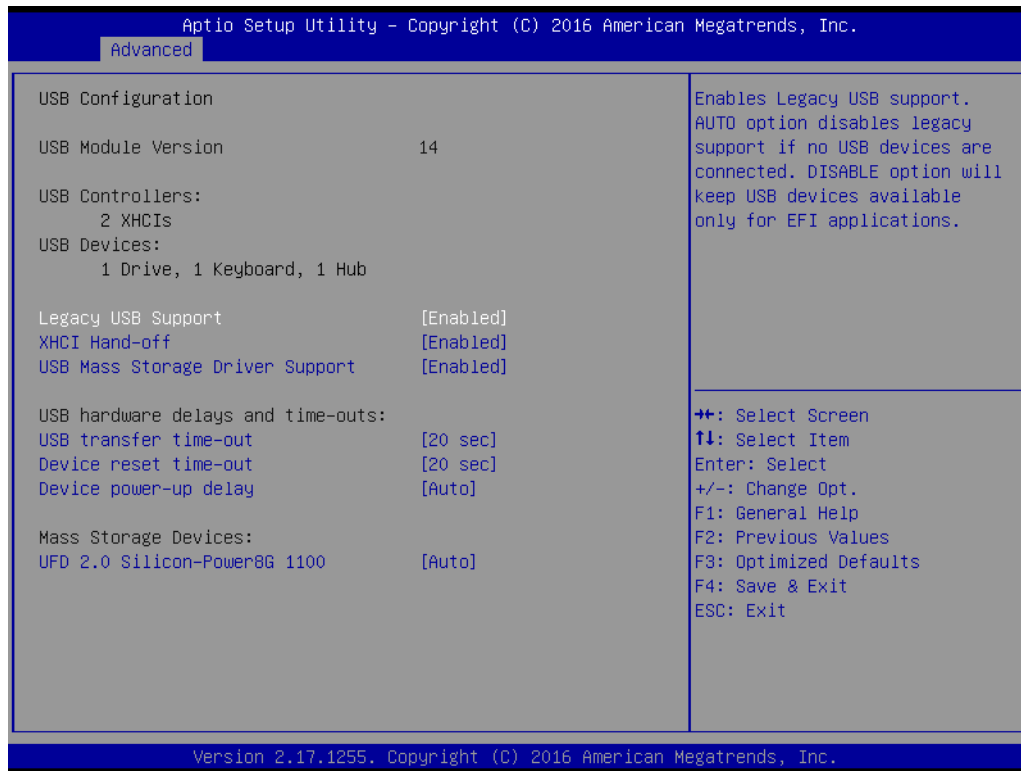

- **Legacy USB Support [ Enabled ]**  
Enables support for legacy USB. Auto option disables legacy support if no USB devices are connected.
- **XHCI Hand-off [ Enabled ]**
- **USB Mass Storage Driver Support [ Enabled ]**
- **USB hardware delays and time-outs**  
USB Device transfer & reset time-out and delay setting.
- **Mass Storage Devices [ Auto ]**  
Shows USB mass storage device information.

### 3.3 Chipset Configuration Setting

Select the chipset tab from the BIOS setup screen to enter the Chipset Setup screen. Users can select any item in the left frame of the screen, such as PCI express Configuration, to go to the sub menu for that item. Users can display a Chipset Setup option by highlighting it using the <Arrow> keys. All Chipset Setup options are described in this section. The Chipset Setup screens are shown below. The sub menus are described on the following pages.



### 3.3.1 System Agent (SA) Configuration

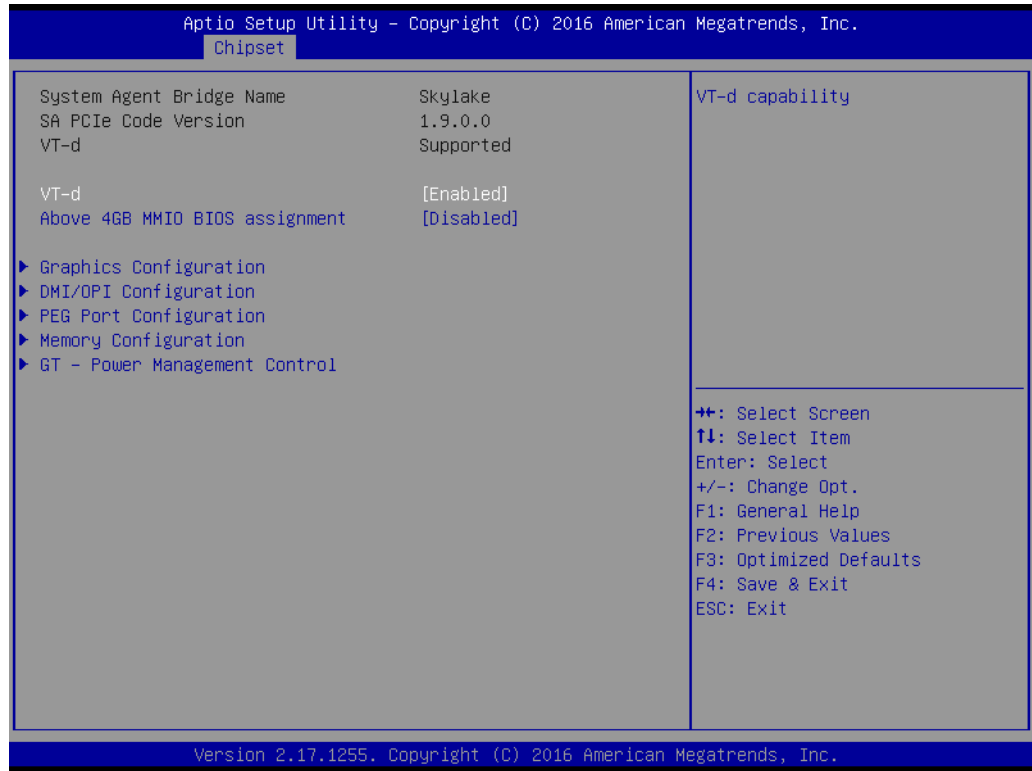

- **VT-d [ Enabled ]**  
Disable or enable VT-d function on MCH.

### 3.3.1.1 Graphics Configuration

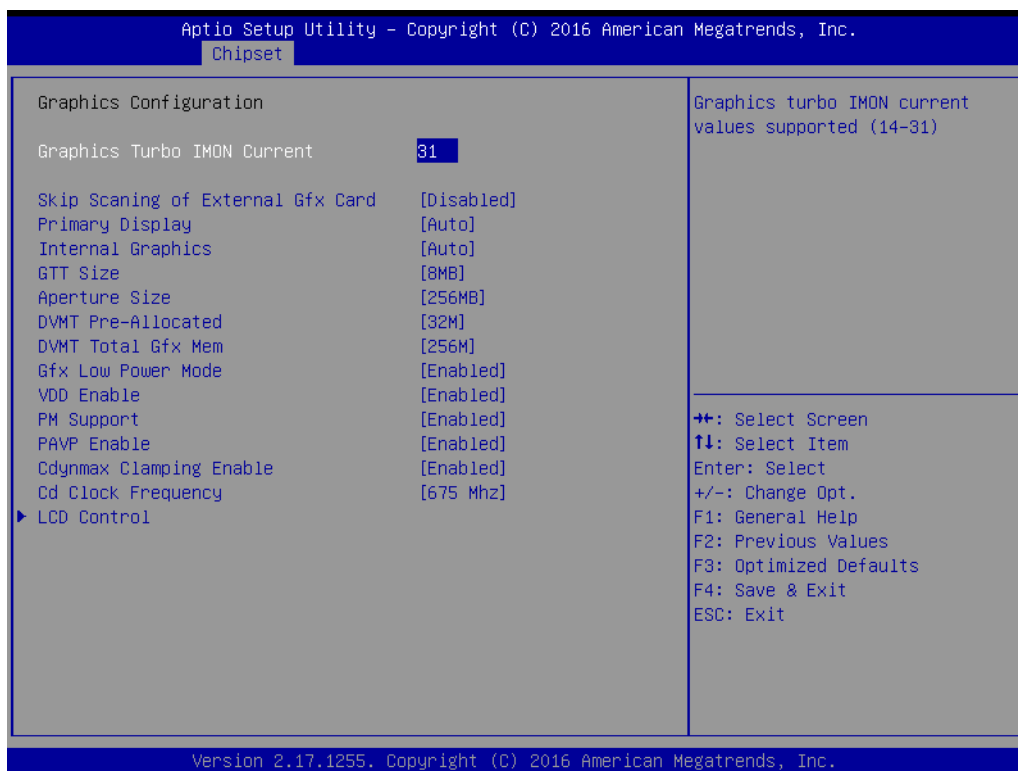

- **Graphics Turbo IMON Current [ 14-31 ]**
- **Skip Scanning of External Gfx Card [disabled]**
- **Primary Display [ Auto ]**  
Select which of IGFX/PEG/PCI Graphics device should be Primary Display
- **Internal Graphics [ Auto ]**  
Keep IGD enabled based on the setup options.
- **GTT size [8MB]**
- **Aperture Size [ 256MB ]**
- **DVMT Pre-Allocated [ 32M ]**  
Select DVMT 5.0 Pre-Allocated (Fixed) Graphics Memory size used by the Internal Graphics Device.
- **DVMT Total Gfx Mem [ 256M ]**  
Select DVMT5.0 Total Graphic Memory size used by the Internal Graphics Device.
- **Gfx Low Power Mode [ Enabled ]**

**Note!** When BIOS set as "Auto", only a single display works under DOS.



**Note!** The triple display can only work under Windows 7 and 8, the 2nd display can not work under DOS.



Below is the 2/3 display combination table, all of these combinations are verified and tested.

Display Combination List	BIOS	DOS	WES 8
<b>Single Display</b>			
VGA	PASS	PASS	PASS
DVI	PASS	PASS	PASS
DP	PASS	PASS	PASS
EDP/LVDS	PASS	PASS	PASS
<b>Dual Display</b>			
VGA+DVI	NA	NA	PASS
VGA+EDP/LVDS	NA	NA	PASS
VGA+DP	NA	NA	PASS
DVI+DP	NA	NA	PASS
DVI+EDP/LVDS	NA	NA	PASS
DP+EDP/LVDS	NA	NA	PASS

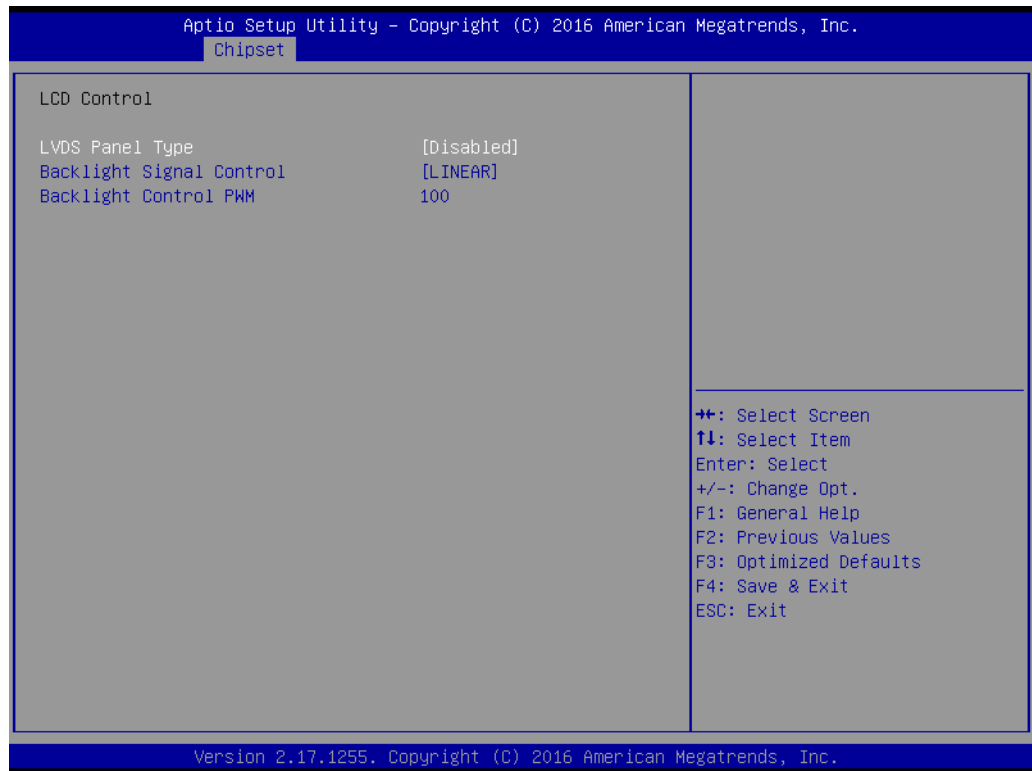



### 3.3.1.2 DMI Configuration

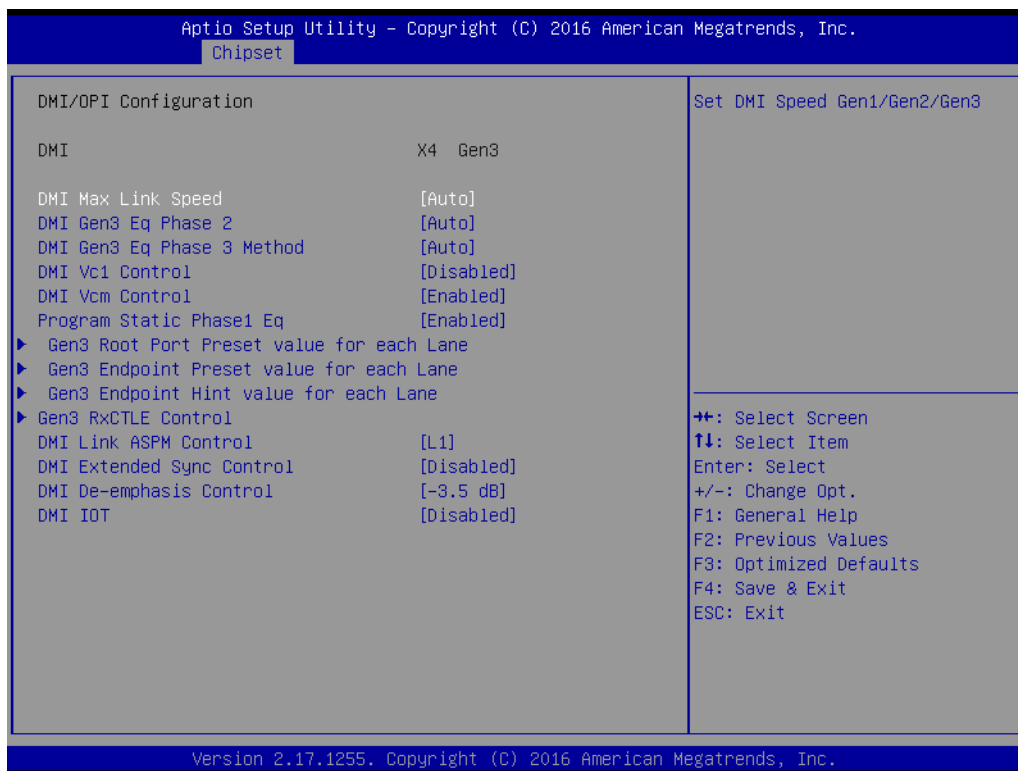

- **DMI Vc1 Control [ Disabled ]**
- **DMI Vcm Control [ Enabled ]**
- **DMI Link ASPM Control [ L1 ]**  
 Enable or disable the control of Active State Power Management on SA side of the DMI Link.
- **DMI Extended Synch Control [ Disabled ]**  
 Enable DMI Extended Synchronization.
- **DMI De-emphasis Control [ -3.5 dB ]**  
 Configure the De-emphasis control on DMI
- **DMI IOT [ Disabled ]**

### 3.3.1.3 PEG Port Configuration

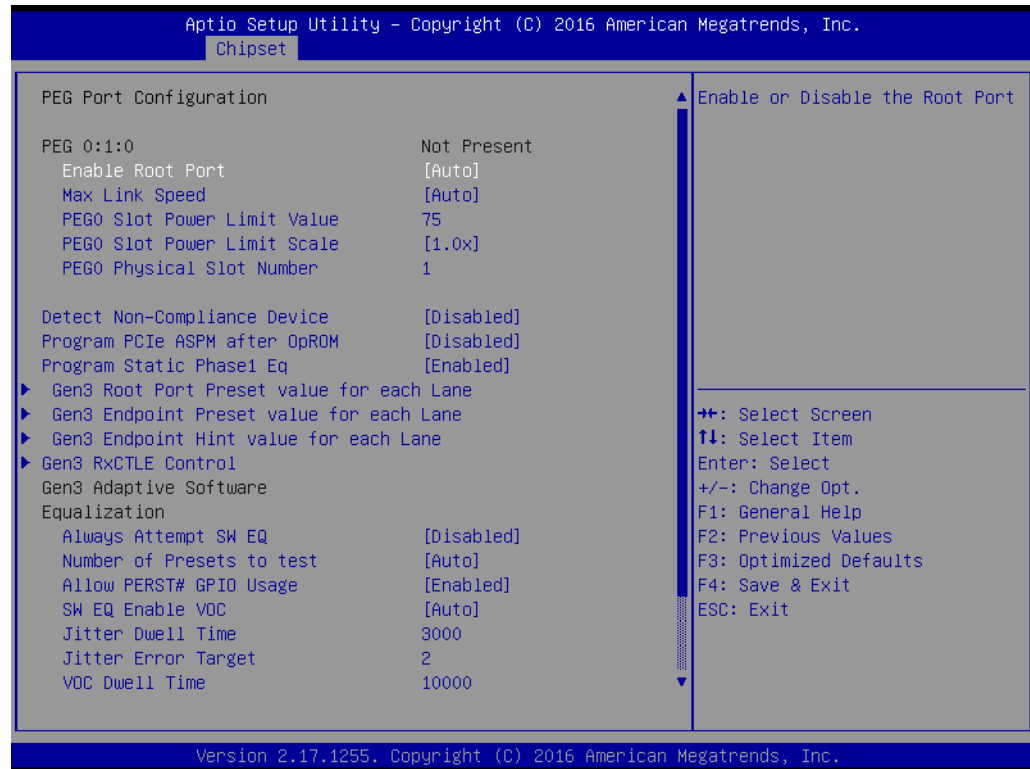

- **Enable Root Port [ Auto ]**
- **Max Link Speed [Auto]**
- **Detect Non-Compliance Device [ Disabled ]**  
Detect Non-Compliance PCI Express Device in PEG
- **Program PCIe ASPM after OpROM [ Disabled ]**  
Enabled: PCIe ASPM will be programmed after OpROM.  
Disabled: PCIe ASPM will be programmed before OpROM.
- **Program Static Phase1 Eq [Enabled]**
- **PEG Gen3 Root Port Preset Value for each Lane**  
Root Port Preset Value Per lane for Gen3 Equalization.
- **PEG Gen3 Endpoint Preset Value for each Lane**  
Endpoint Preset Value Per lane for Gen3 Equalization.
- **PEG Gen3 Endpoint Hint Value each Lane**  
Endpoint Hint Value Per lane for Gen3 Equalization.

### 3.3.1.4 Memory Configuration



The item shows you memory specification included RC version, Frequency, size and voltage information etc.

- **Max TOLUD [ Dynamic ]**  
Maximum Value of TOLUD. Dynamic assignment would adjust TOLUD automatically based on largest MMIO length of installed graphic controller.
- **Retrain on Fast Fail [Enabled]**  
Enable or disable Retrain on Fast Fail.
- **Memory Remap [Enabled]**  
Enable or disable Memory remap.
- **Fast Boot [Enabled]**  
Enable or disable Fast Boot support.

## 3.3.2 PCH-IO Configuration

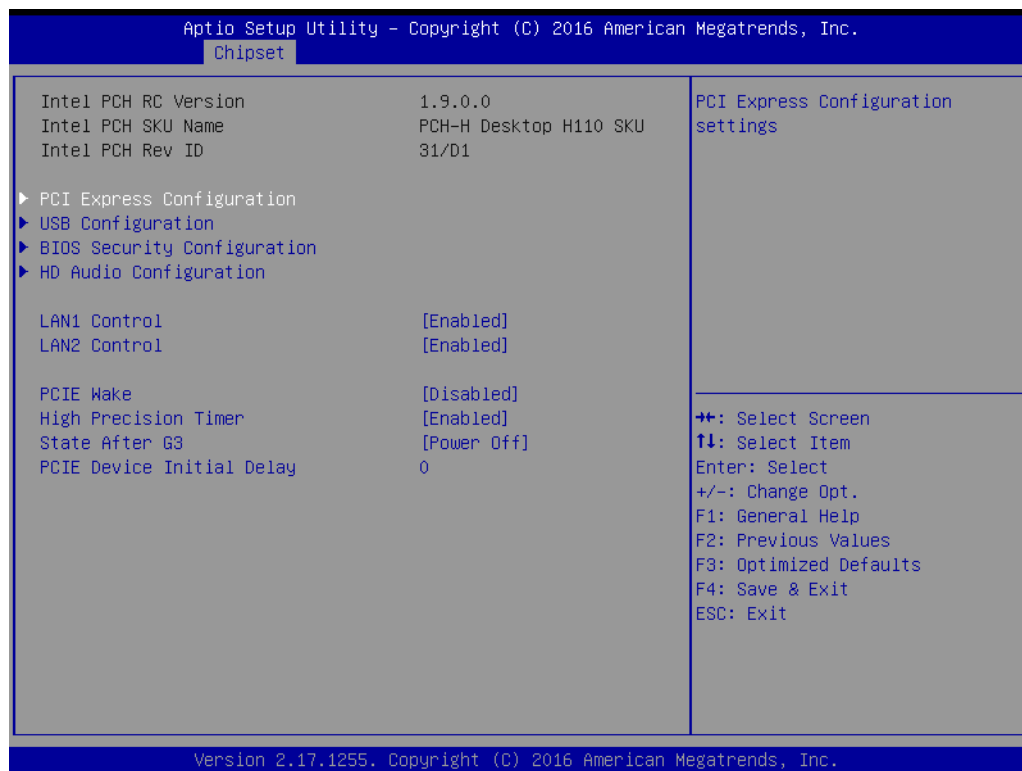

- **PCI Express Configuration**  
Details of PCI Express items. (See 3.3.2.1)
- **USB Configuration**  
Details of USB items. (See 3.3.2.2)
- **BIOS Security Configuration**  
Details of BIOS security items. (See 3.3.2.3)
- **LAN 1 controller [ Enabled ]**  
Enable or disable the LAN 1 controller.
- **LAN 2 controller [ Enabled ]**
- **PCIE Wake [ Disabled ]**  
Enable or disable PCIE to wake the system from S5.
- **High Precision Timer**  
Enable or Disable High Precision Timer.
- **State After G3 [ Power Off ]**  
This item allows users to select off, on and last state.

### 3.3.2.1 PCI Express Configuration

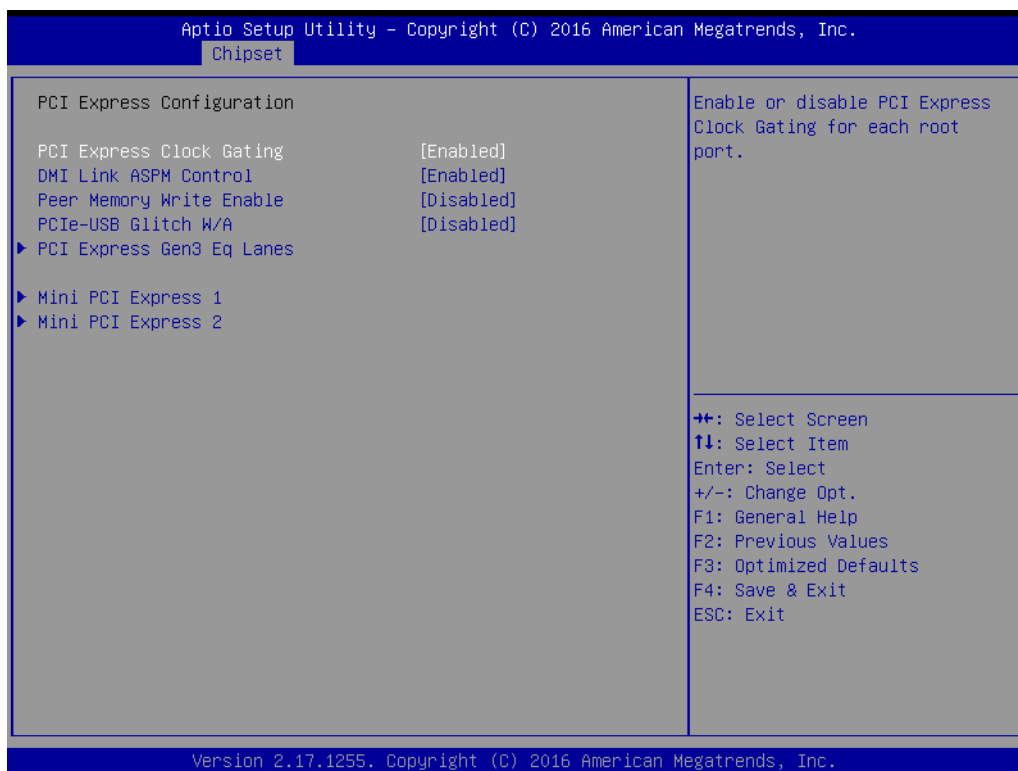

- **PCI Express Clock Gating [ Enabled ]**  
Enable or Disable PCI Express clock gating for each port.
- **DMI Link ASPM Control [ Enabled ]**  
The control of Active State Power Management on both NB side and SB side of the DMI Link.
- **Peer Memory Write Enable [Disabled]**
- **PCIe-USB Glitch W/A [ Disabled ]**  
PCIe-USB Glitch W/A for bad USB device(s) connected behind PCIE/PEG Port.

## ■ PCI Express Root Port

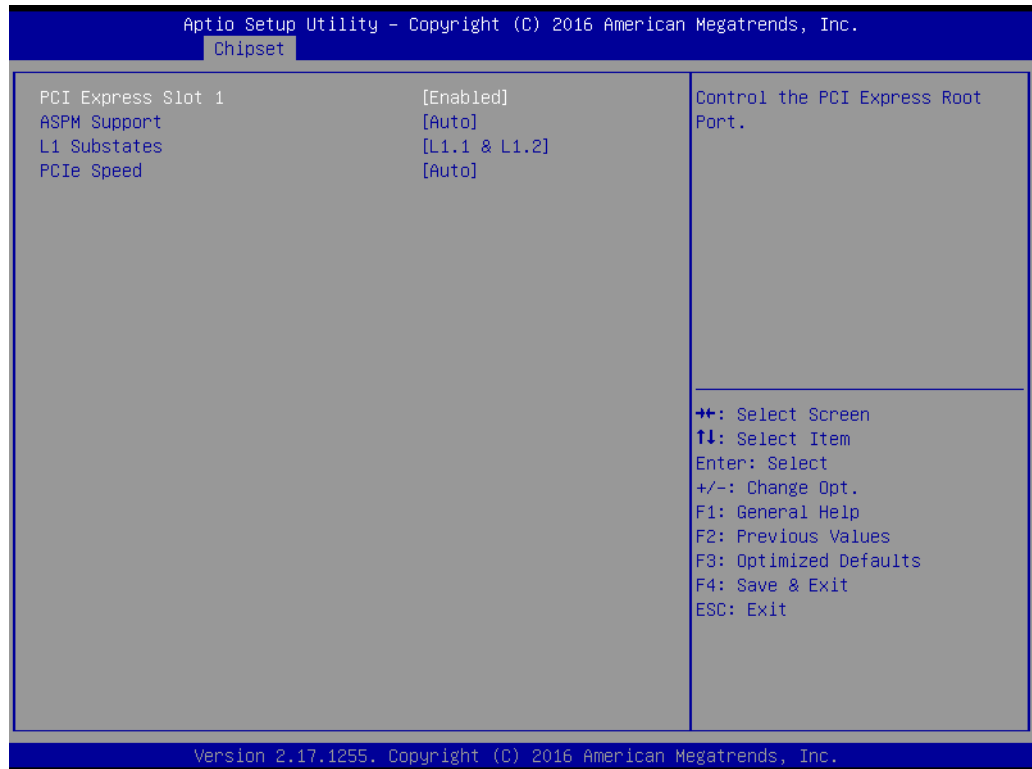

- **PCI Express Root Port 1 [ Enabled ]**  
Control the PCI Express Root Port.
- **ASPM Support [ Auto ]**  
Set the ASPM Level: Force L0s - Force all links to L0s State : AUTO - BIOS auto configure : DISABLE - Disables ASPM
- **L1 Substates PCI Express L1 Substates settings.**
- **PCIe Speed [ Auto ]**  
Select PCI Express port speed.

## ■ PCI Express Root Port 2

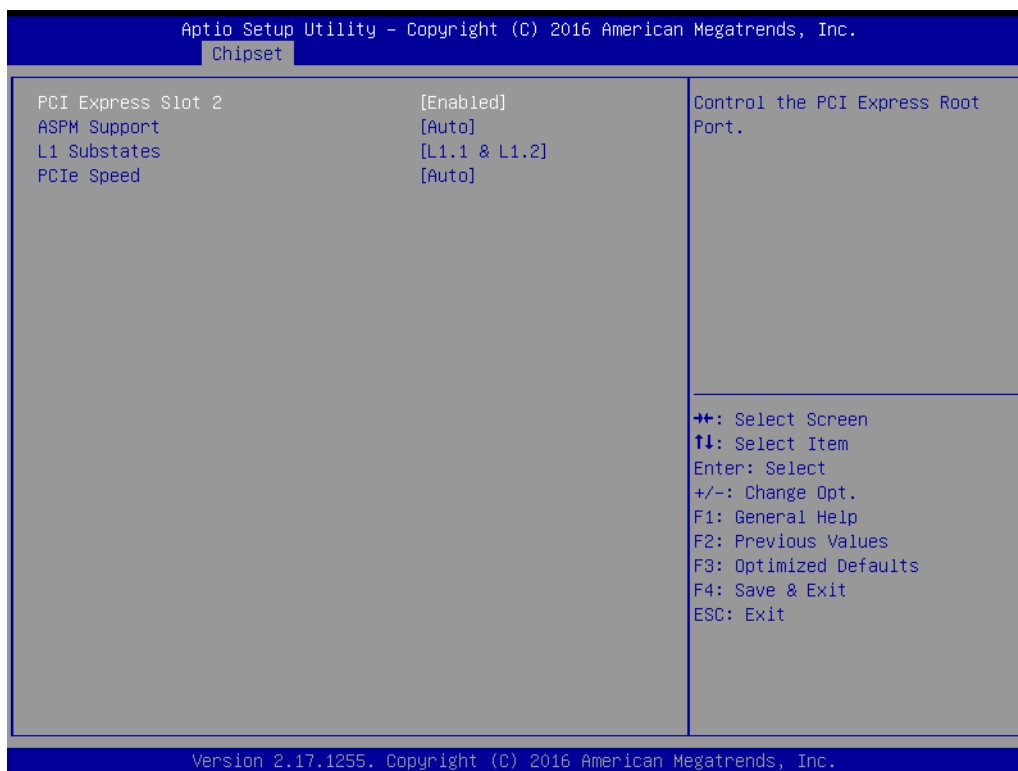

- **PCI Express Root Port 2 [ Enabled ]**  
Control the PCI Express Root Port.
- **ASPM Support [ Auto ]**  
Set the ASPM Level: Force L0s - Force all links to L0s State : AUTO - BIOS auto configure : DISABLE - Disables ASPM
- **L1 Substates PCI Express L1 Substates settings.**
- **PCIe Speed [ Auto ]**  
Select PCI Express port speed.

## ■ Mini PCI Express

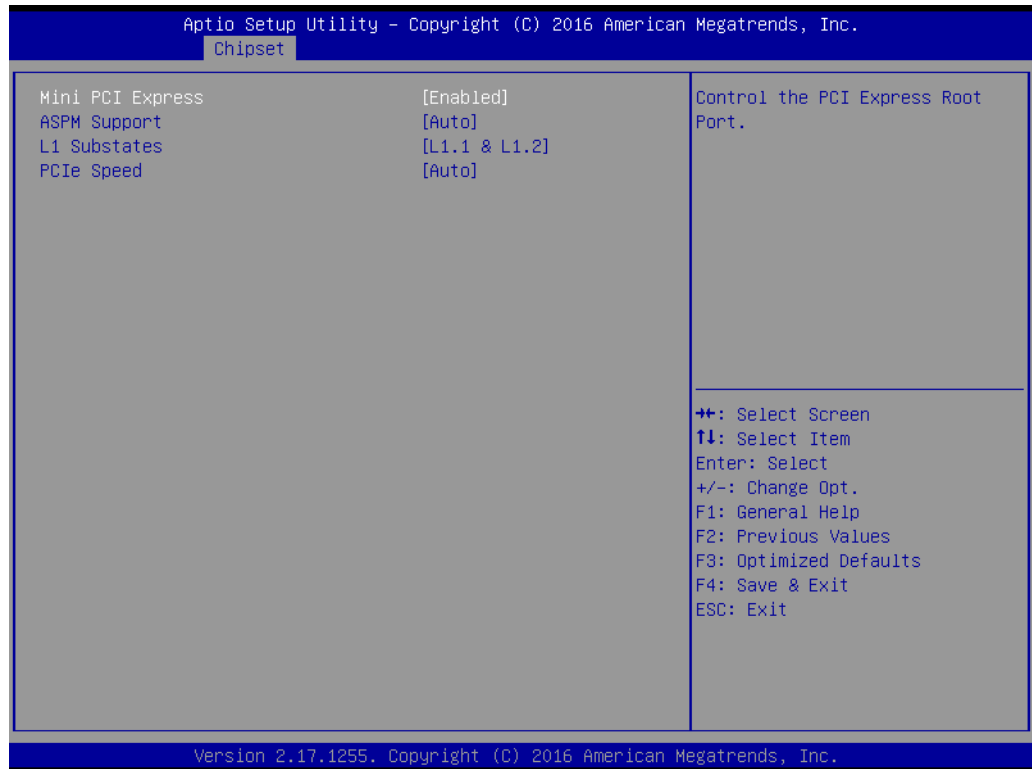

- **Mini PCI Express [ Enabled ]**  
Control the Mini PCI Express Root Port.
- **ASPM Support [ Auto ]**  
Set the ASPM Level: Force L0s - Force all links to L0s State : AUTO - BIOS auto configure : DISABLE - Disables ASPM
- **L1 Substates PCI Express L1 Substates settings.**
- **PCIe Speed [ Auto ]**  
Select Mini PCI Express port speed.



### 3.3.2.2 USB Configuration

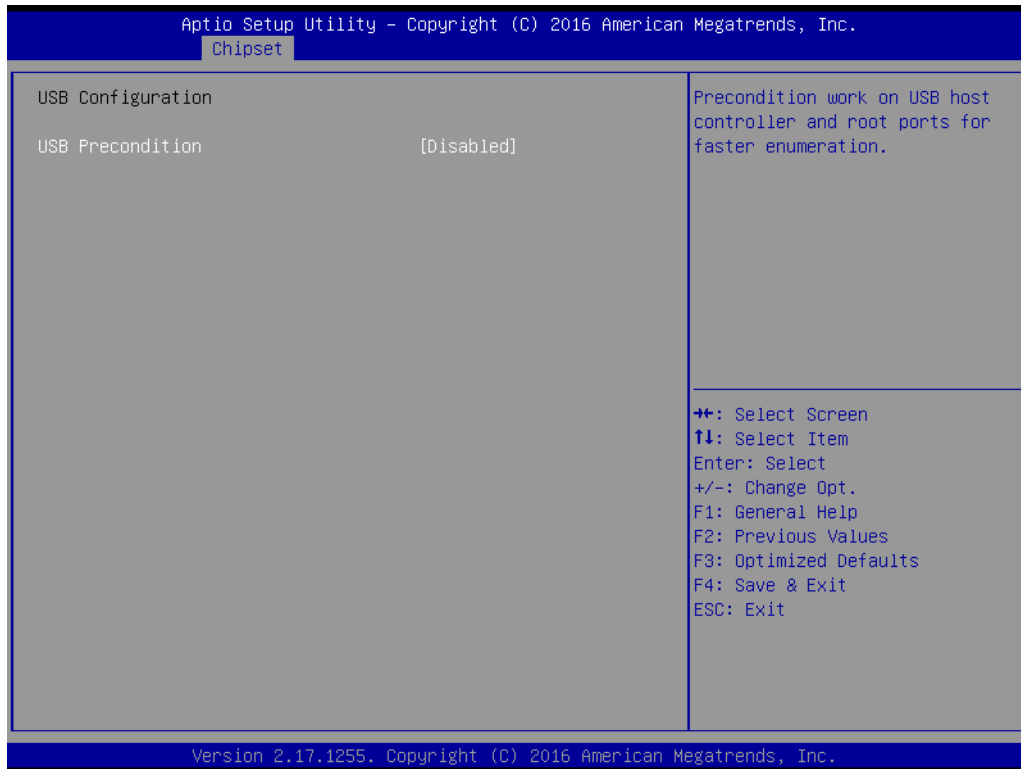

- **USB Preconditon [ Disabled ]**  
Enable or disables USB precondition on USB host controller for faster enumeration.

## 3.4 Security Setting

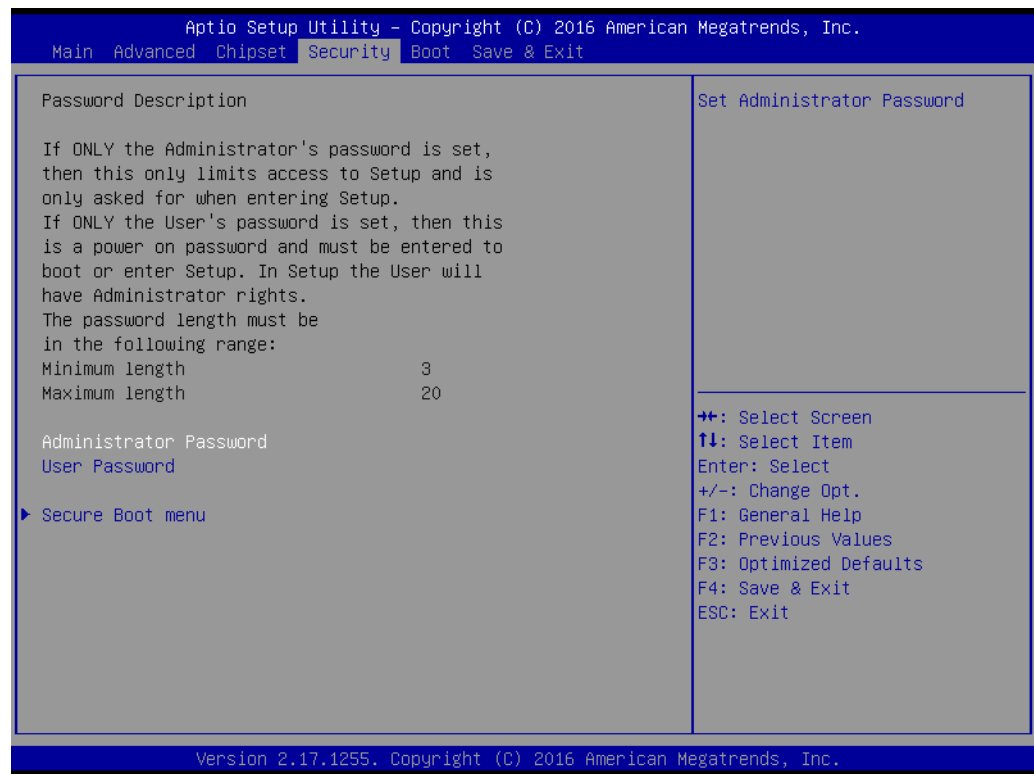

- **Administrator Password**  
Select this option and press <ENTER> to access the sub menu, and then type in the password. Set the Administrator password.
- **User Password**  
Select this option and press <ENTER> to access the sub menu, and then type in the password. Set the User Password.

## 3.5 Boot Setting



- **Setup Prompt Timeout**  
User the <+> and <-> keys to adjust the number of seconds to wait for setup activation key.
- **Bootup NumLock State [ On ]**  
On or Off power on state for the NumLock
- **Quiet Boot [ Disabled ]**  
If this option is set to disabled, the BIOS displays normal POST messages. If enabled, an OEM logo is shown instead of POST messages.
- **Boot Option #1/#2**  
Choose boot priority from boot device

## 3.6 Save & Exit Configuration

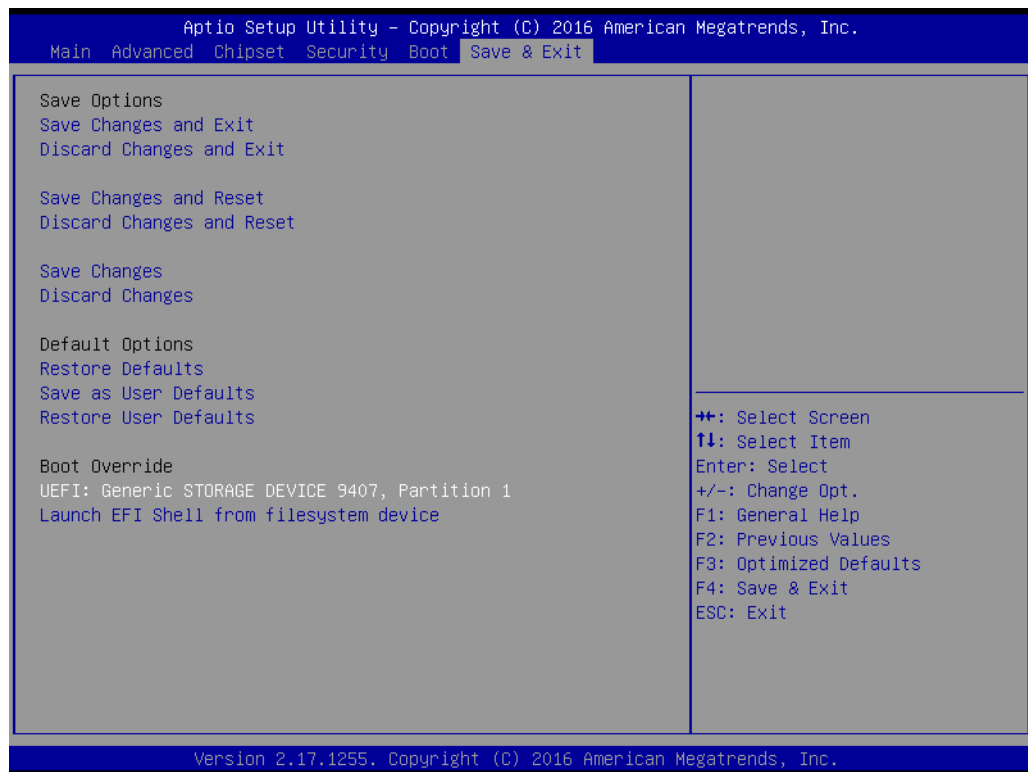

### ■ Save Changes and Exit

When users have completed system configuration, select this option to save changes, exit BIOS setup menu and reboot the computer to take effect of all system configuration parameters.

1. Select Exit Saving Changes from the Exit menu and press <Enter>. The following message appears: Save Configuration Changes and Exit Now? [Ok] [Cancel]
2. Select Ok or cancel.

### ■ Discard Changes and Exit

Select this option to quit Setup without making any permanent changes to the system configuration.

1. Select Exit Discarding Changes from the Exit menu and press <Enter>. The following message appears: Discard Changes and Exit Setup Now? [Ok] [Cancel]
2. Select Ok to discard changes and exit. Discard Changes  
Select Discard Changes from the Exit menu and press <Enter>.

### ■ Save Changes and Reset

When users have completed system configuration, select this option to save changes, exit BIOS setup menu and reboot the computer to take effect of all system configuration parameters.

1. Select Exit Saving Changes from the Exit menu and press <Enter>. The following message appears: Save Configuration Changes and Exit Now? [Ok] [Cancel]
2. Select Ok or cancel.

### ■ Discard Changes and Reset

Select this option to quit Setup without making any permanent changes to the system configuration.

1. Select Reset Discarding Changes from the Exit menu and press <Enter>. The following message appears: Discard Changes and Exit Setup Now? [Ok] [Cancel]
  2. Select Ok to discard changes and reset. Discard Changes  
Select Discard Changes from the Exit menu and press <Enter>.
- **Restore Default**  
The BIOS automatically configures all setup items to optimal settings when users select this option. Defaults are designed for maximum system performance, but may not work best for all computer applications. In particular, do not use the Defaults if the user's computer is experiencing system configuration problems. Select Restore Defaults from the Exit menu and press <Enter>.
  - **Save as User Default**  
Save the all current settings as a user default.
  - **Restore User Default**  
Restore all settings to user default values.



# Chapter 4

Software Introduction  
& Service

## 4.1 Introduction

The mission of Advantech Embedded Software Services is to "Enhance quality of life with Advantech platforms and Microsoft® Windows® embedded technology." We enable Windows® Embedded software products on Advantech platforms to more effectively support the embedded computing community. Customers are freed from the hassle of dealing with multiple vendors (hardware suppliers, system integrators, embedded OS distributors) for projects. Our goal is to make Windows® Embedded Software solutions easily and widely available to the embedded computing community.

## 4.2 Value-Added Software Services

Software API: An interface that defines the ways by which an application program may request services from libraries and/or operating systems. Provides not only the underlying drivers required but also a rich set of user-friendly, intelligent and integrated interfaces, which speeds development, enhances security and offers add-on value for Advantech platforms. It plays the role of catalyst between developer and solution, and makes Advantech embedded platforms easier and simpler to adopt and operate with customer applications.

### 4.2.1 Software API

#### 4.2.1.1 Control

##### GPIO



General Purpose Input/Output is a flexible parallel interface that allows a variety of custom connections. It allows users to monitor the level of signal input or set the output status to switch on/off the device. Our API also provides Programmable GPIO, which allows developers to dynamically set the GPIO input or output status.

##### SMBus



SMBus is the System Management Bus defined by Intel Corporation in 1995. It is used in personal computers and servers for low-speed system management communications. The SMBus API allows a developer to interface a embedded system environment and transfer serial messages using the SMBus protocols, allowing multiple simultaneous device control.



#### 4.2.1.2 Display

##### Brightness Control



The Brightness Control API allows a developer to access embedded devices and easily control brightness.

##### Backlight



The Backlight API allows a developer to control the backlight (screen) on/off in embedded devices.

#### 4.2.1.3 Monitor

##### Watchdog



A watchdog timer (WDT) is a device that performs a specific operation after a certain period of time if something goes wrong and the system does not recover on its own. A watchdog timer can be programmed to perform a warm boot (restarting the system) after a certain number of seconds.

##### Hardware Monitor



The Hardware Monitor (HWM) API is a system health supervision API that inspects certain condition indexes, such as fan speed, temperature and voltage.

#### 4.2.1.4 Power Saving

##### CPU Speed



Makes use of Intel SpeedStep technology to save power consumption. The system will automatically adjust the CPU speed depending on the system loading.

##### System Throttling

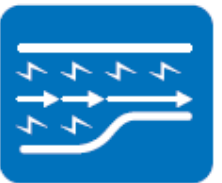

Refers to a series of methods for reducing power consumption in computers by lowering the clock frequency. This API allows the user to adjust the clock from 87.5% to 12.5%.

---

## 4.2.2 Software Utility

### BIOS Flash

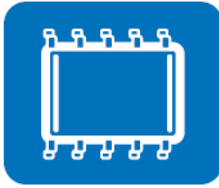

The BIOS Flash utility allows customers to update the flash ROM BIOS version, or use it to back up current BIOS by copying it from the flash chip to a file on the customers' disk. The BIOS Flash utility also provides a command line version and an API for fast implementation into customized applications.

### Monitoring



Monitoring is a utility for customers to monitor system health, like voltage, CPU and system temperature and fan speed. These items are important to a device, if critical errors occur and are not solved immediately, permanent damage may be caused.

# Chapter 5

Chipset Software  
Installation Utility

---

## 5.1 Before You Begin

To facilitate the installation of the enhanced display drivers and utility software, read the instructions in this chapter carefully. The drivers for AIMB-505 are located on Advantech website. ([http://support.advantech.com/Support/.](http://support.advantech.com/Support/)) Updates are provided via Service Packs from Microsoft\*.

Before you begin, it is important to note that most display drivers need to have the relevant software application already installed in the system prior to installing the enhanced display drivers. In addition, many of the installation procedures assume that you are familiar with both the relevant software applications and operating system commands. Review the relevant operating system commands and the pertinent sections of your application software's user manual before performing the installation.

## 5.2 Introduction

The Intel® Chipset Software Installation (CSI) utility installs the Windows INF files that outline to the operating system how the chipset components will be configured. This is needed for the proper functioning of the following features:

- Core PCI PnP services
- IDE Ultra ATA 100/66/33 and Serial ATA interface support
- Identification of Intel® chipset components in the Device Manager

**Note!** *This utility is used for the following versions of Windows, and it has to be installed **before** installing all the other drivers:*



- Windows 7 (32-bit)
- Windows 7 (64-bit)
- Windows 8 (64 bit)
- Windows 10 (64 bit)

## 5.3 Windows 8.1 Driver Setup

1. When enter the website of Advantech, then search product AIMB-505. There is "Chipset" driver inside.

### Win8(64bit) driver for AIMB-505

Solution : Win8(64bit) driver for AIMB-505

Download File	Released Date	Download Site	
AIMB-505_CIR_Win8.1(64bit).zip	2016-08-01	Primary	Secondary
AIMB-505_Audio_Win8.1(64bit).zip	2016-08-01	Primary	Secondary
AIMB-505_ME_Win8.1(64bit).zip	2016-08-01	Primary	Secondary
AIMB-505_LAN_Win8.1(64bit).7z	2016-08-01	Primary	Secondary
AIMB-505_Graphic_Win8.1(64bit).zip	2016-08-01	Primary	Secondary
AIMB-505_RAID-AHCI_Win8.1(64bit).zip	2016-07-29	Primary	Secondary
AIMB-505_USB3.0_Win8.1(64bit).zip	2016-07-29	Primary	Secondary
AIMB-505_COM_Win8.1(64bit).zip	2016-07-29	Primary	Secondary
AIMB-505_Chipset_Win8.1(64bit).zip	2016-07-29	Primary	Secondary



# Chapter 6

## VGA Setup

## 6.1 Introduction

The Core i7/i5/i3, Pentium and Celeron CPUs are embedded with an integrated graphics controller. You need to install the VGA driver to enable this function.

Optimized integrated graphic solution: Intel Graphics, versatile display options and 32-bit 3D graphics engine are supported. Dual independent displays and enhanced display modes for widescreen flat panels include extended, twin, and clone dual display modes, plus optimized 3D support delivers an intensive and realistic visual experience.

## 6.2 Windows 8.1 VGA Driver Installation

**Note!** *Before installing this driver, make sure the CSI utility has been installed in your system. See Chapter 5 for information on installing the CSI utility.*



When enter the website of Advantech, then search product AIMB-505. There are "Graphic" drivers available.

### Win8(64bit) driver for AIMB-505

Solution : Win8(64bit) driver for AIMB-505

Download File	Released Date	Download Site	
AIMB-505_CIR_Win8.1(64bit).zip	2016-08-01	Primary	Secondary
AIMB-505_Audio_Win8.1(64bit).zip	2016-08-01	Primary	Secondary
AIMB-505_ME_Win8.1(64bit).zip	2016-08-01	Primary	Secondary
AIMB-505_LAN_Win8.1(64bit).7z	2016-08-01	Primary	Secondary
AIMB-505_Graphic_Win8.1(64bit).zip	2016-08-01	Primary	Secondary
AIMB-505_RAID-AHCI_Win8.1(64bit).zip	2016-07-29	Primary	Secondary
AIMB-505_USB3.0_Win8.1(64bit).zip	2016-07-29	Primary	Secondary
AIMB-505_COM_Win8.1(64bit).zip	2016-07-29	Primary	Secondary
AIMB-505_Chipset_Win8.1(64bit).zip	2016-07-29	Primary	Secondary



# Chapter 7

## LAN Configuration

---

## 7.1 Introduction

The AIMB-505 has dual Gigabit Ethernet LANs via dedicated PCI Express x1 lanes (Realtek 8111G) that offer bandwidth of up to 500 MB/sec, eliminating the bottleneck of network data flow and incorporating Gigabit Ethernet at 1000 Mbps.

## 7.2 Features

- Integrated 10/100/1000 Mbps transceiver
- 10/100/1000 Mbps triple-speed MAC
- High-speed RISC core with 24-KB cache
- On-chip voltage regulation
- Wake-on-LAN (WOL) support
- PCI Express X1 host interface

## 7.3 Installation

**Note!** *Before installing the LAN drivers, make sure the CSI utility has been installed on your system. See Chapter 5 for information on installing the CSI utility.*



The AIMB-505's Realtek 8111G Gigabit integrated controllers support all major network operating systems. However, the installation procedure varies from system to system. Please find and use the section that provides the driver setup procedure for the operating system you are using.

## 7.4 Windows® 8.1 Driver Setup (Realtek 8111G)

When enter the website of Advantech, then search product AIMB-505.

There is "LAN" driver inside.

### Win8(64bit) driver for AIMB-505

Solution : Win8(64bit) driver for AIMB-505

Download File	Released Date	Download Site	
AIMB-505_CIR_Win8.1(64bit).zip	2016-08-01	Primary	Secondary
AIMB-505_Audio_Win8.1(64bit).zip	2016-08-01	Primary	Secondary
AIMB-505_ME_Win8.1(64bit).zip	2016-08-01	Primary	Secondary
AIMB-505_LAN_Win8.1(64bit).7z	2016-08-01	Primary	Secondary
AIMB-505_Graphic_Win8.1(64bit).zip	2016-08-01	Primary	Secondary
AIMB-505_RAID-AHCI_Win8.1(64bit).zip	2016-07-29	Primary	Secondary
AIMB-505_USB3.0_Win8.1(64bit).zip	2016-07-29	Primary	Secondary
AIMB-505_COM_Win8.1(64bit).zip	2016-07-29	Primary	Secondary
AIMB-505_Chipset_Win8.1(64bit).zip	2016-07-29	Primary	Secondary



# Appendix **A**

Programming the  
Watchdog Timer

---

## A.1 Programming the Watchdog Timer

AIMB-505's watchdog timer can be used to monitor system software operation and take corrective action if the software fails to function within the programmed period. This section describes the operation of the watchdog timer and how to program it.

### A.1.1 Watchdog Timer Overview

The watchdog timer is built into the super I/O controller Nuvoton NCT6779D. It provides the following user-programmable functions:

- Can be enabled and disabled by user program
- Timer can be set from 1 to 255 seconds or 1 to 255 minutes
- Generates an interrupt or resets signal if the software fails to reset the timer before time-out

### A.1.2 Programming the Watchdog Timer

The I/O port address of the watchdog timer is 2E (hex) and 2F (hex). 2E (hex) is the address port. 2F (hex) is the data port. You must first assign the address of register by writing an address value into address port 2E (hex), then write/read data to/from the assigned register through data port 2F (hex).

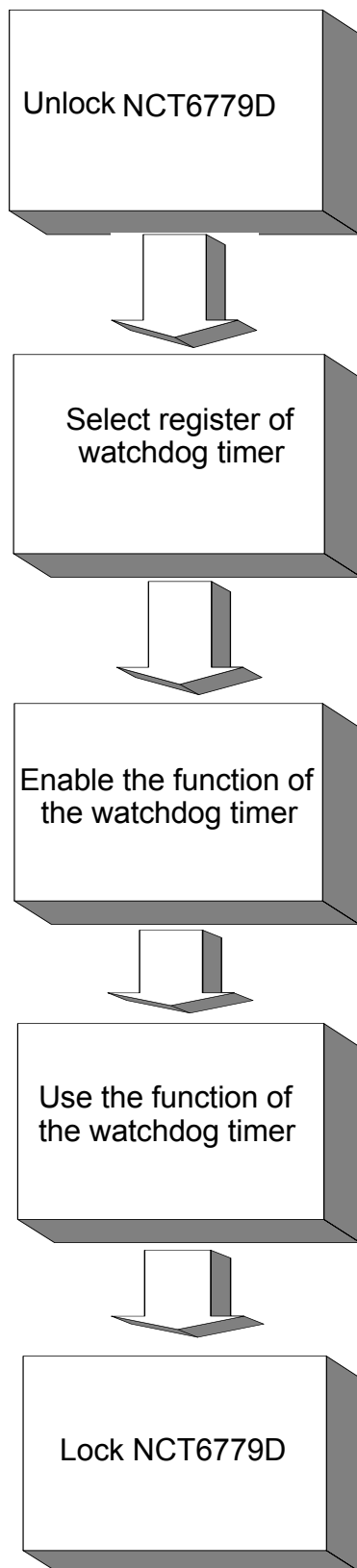

**Table A.1: Watchdog Timer Registers**

Address of Register (2E)	Attribute	Value (2F) & description
87 (hex)	-----	Write this address to I/O address port 2E (hex) twice to unlock the NCT3779D.
07 (hex)	write	Write 08 (hex) to select register of watchdog timer.
30 (hex)	write	Write 01 (hex) to enable the function of the watchdog timer. Disabled is set as default.
F5 (hex)	write	Set seconds or minutes as units for the timer. Write 0 to bit 3: set second as counting unit. [default] Write 1 to bit 3: set minutes as counting unit.
F6 (hex)	write	0: stop timer [default] 01~FF (hex): The amount of the count, in seconds or minutes, depends on the value set in register F5 (hex). This number decides how long the watchdog timer waits for strobe before generating an interrupt or reset signal. Writing a new value to this register can reset the timer to count with the new value.
F7 (hex)	read/write	Bit 7: Write 1 to enable mouse to reset the timer, 0 to disable [default]. Bit 6: Write 1 to enable keyboard to reset the timer, 0 to disable. [default] Bit 5: Write 1 to generate a timeout signal immediately and automatically return to 0. [default=0] Bit 4: Read status of watchdog timer, 1 means timer is "timeout".
AA (hex)	-----	Write this address to I/O port 2E (hex) to lock the watchdog timer 2.



### A.1.3 Example Program

1. Enable watchdog timer and set 10 sec. as timeout interval

```

;-----
Mov dx,2eh ; Unlock NCT6779D
Mov al,87h
Out dx,al
Out dx,al
;-----
Mov al,07h ; Select registers of watchdog timer
Out dx,al
Inc dx
Mov al,08h
Out dx,al
;-----
Dec dx ; Enable the function of watchdog timer
Mov al,30h
Out dx,al
Inc dx
Mov al,01h
Out dx,al
;-----
Dec dx ; Set second as counting unit
Mov al,0f5h
Out dx,al
Inc dx
In al,dx
And al,not 08h
Out dx,al
;-----
Dec dx ; Set timeout interval as 10 seconds and start counting
Mov al,0f6h
Out dx,al
Inc dx
Mov al,10
Out dx,al
;-----
Dec dx ; Lock NCT6779D
Mov al,0aah
Out dx,al

```

2. Enable watchdog timer and set 5 minutes as timeout interval

```

;-----
Mov dx,2eh ; Unlock NCT6779D
Mov al,87h
Out dx,al
Out dx,al

```

```

;-----
Mov al,07h ; Select registers of watchdog timer
Out dx,al
Inc dx
Mov al,08h
Out dx,al
;-----
Dec dx ; Enable the function of watchdog timer
Mov al,30h
Out dx,al
Inc dx
Mov al,01h
Out dx,al
;-----
Dec dx ; Set minute as counting unit
Mov al,0f5h
Out dx,al
Inc dx
In al,dx
Or al,08h
Out dx,al
;-----
Dec dx ; Set timeout interval as 5 minutes and start counting
Mov al,0f6h
Out dx,al
Inc dx
Mov al,5
Out dx,al
;-----
Dec dx ; Lock NCT6779D
Mov al,0aah
Out dx,al
3. Enable watchdog timer to be reset by mouse
;-----
Mov dx,2eh ; Unlock NCT6779D
Mov al,87h
Out dx,al
Out dx,al
;-----
Mov al,07h ; Select registers of watchdog timer
Out dx,al
Inc dx
Mov al,08h
Out dx,al
;-----

```

```

Dec dx ; Enable the function of watchdog timer
Mov al,30h
Out dx,al
Inc dx
Mov al,01h
Out dx,al
;-----
Dec dx ; Enable watchdog timer to be reset by mouse
Mov al,0f7h
Out dx,al
Inc dx
In al,dx
Or al,80h
Out dx,al
;-----
Dec dx ; Lock NCT6779D
Mov al,0aah
Out dx,al
4. Enable watchdog timer to be reset by keyboard
;-----
Mov dx,2eh ; Unlock NCT6779D
Mov al,87h
Out dx,al
Out dx,al
;-----
Mov al,07h ; Select registers of watchdog timer
Out dx,al
Inc dx
Mov al,08h
Out dx,al
;-----
Dec dx ; Enable the function of watchdog timer
Mov al,30h
Out dx,al
Inc dx
Mov al,01h
Out dx,al
;-----
Dec dx ; Enable watchdog timer to be strobed reset by keyboard
Mov al,0f7h
Out dx,al
Inc dx
In al,dx
Or al,40h
Out dx,al

```

```

;-----
Dec dx ; Lock NCT6779D
Mov al,0aah
Out dx,al
5. Generate a time-out signal without timer counting
;-----
Mov dx,2eh ; Unlock NCT6779D
Mov al,87h
Out dx,al
Out dx,al
;-----
Mov al,07h ; Select registers of watchdog timer
Out dx,al
Inc dx
Mov al,08h
Out dx,al
;-----
Dec dx ; Enable the function of watchdog timer
Mov al,30h
Out dx,al
Inc dx
Mov al,01h
Out dx,al
;-----
Dec dx ; Generate a time-out signal
Mov al,0f7h
Out dx,al ;Write 1 to bit 5 of F7 register
Inc dx
In al,dx
Or al,20h
Out dx,al
;-----
Dec dx ; Lock NCT6779D
Mov al,0aah
Out dx,al

```

# Appendix **B**

## Pin Assignments

## B.1 Digital Visual Interface connector (DVI1)

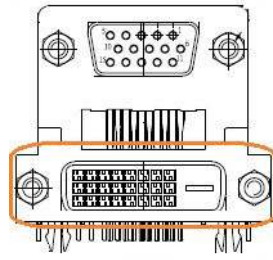

Pin	Signal	Pin	Signal
1	TMDS D2-	13	GND
2	TMDS D2+	14	VCC (+5V)
3	GND	15	GND
4	GND	16	Hot plug detect
5	GND	17	TMDS D0-
6	DDC CLK	18	TMDS D0+
7	DDC DAT	19	GND
8	NC	20	GND
9	TMDS D1-	21	GND
10	TMDS D1+	22	GND
11	GND	23	TMDS CLK+
12	GND	24	TMDS CLK-

## B.2 Video Graphics Array connector (VGA1)

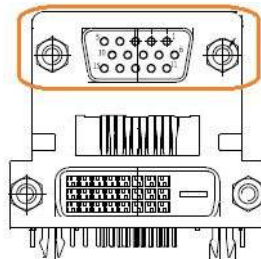

Pin	Signal	Pin	Signal
1	RED	9	VCC (+5V)
2	GREEN	10	GND
3	BLUE	11	N/A
4	N/A	12	DDC DAT
5	GND	13	HSYNC
6	Advantech define	14	VSYNC
7	GND	15	DDC CLK
8	GND		

## B.3 Keyboard & Mouse connector (KBMS1)

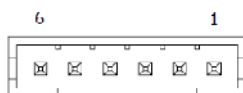

Pin	Signal
1	KB_CLK#
2	KB_DAT#
3	MS_CLK#
4	GND
5	VCC (+5VSB)
6	MS_DAT#

## B.4 DisplayPort1(DP1)

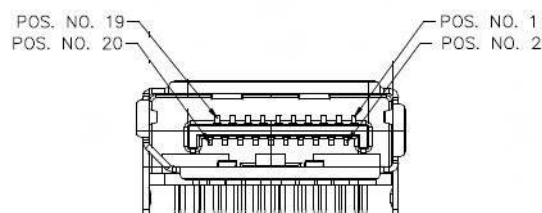

Pin	Signal	Pin	Signal
1	DP1_0+	11	GND
2	GND	12	DP1_3-
3	DP1_0-	13	DP1_AUX_EN#
4	DP1_1+	14	GND
5	GND	15	DP1_AUX+
6	DP1_1-	16	GND
7	DP1_2+	17	DP1_AUX-
8	GND	18	Hot plug detect
9	DP1_2-	19	GND
10	DP1_3+	20	DP_PWR (+3.3V)

## B.5 COM1 connector (COM1)

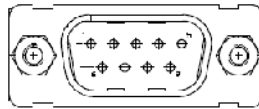

Pin	Signal	Pin	Signal
1	COM1_DCD#	6	COM1_DSR#
2	COM1_SIN	7	COM1_RTS#
3	COM1_SOUT	8	COM1_CTS#
4	COM1_DTR#	9	COM1_RI_V#
5	GND		

## B.6 Universal Serial Bus Port 7 / 8 / 9 / 10 (USB78910)

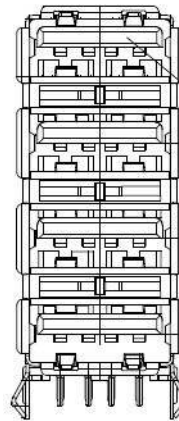

Pin	Signal	Pin	Signal
A1	VBUS (*)	C1	VBUS (*)
A2	USB_D7-	C2	USB_D9-
A3	USB_D7+	C3	USB_D9+
A4	GND	C4	GND
B1	VBUS (*)	D1	VBUS (*)
B2	USB_D8-	D2	USB_D10-
B3	USB_D8+	D3	USB_D10+
B4	GND	D4	GND

(\*) Depends on JUSBPWR2 Jump Setting



## B.7 COM1 RI# selection pin header (JSETCOM1\_V1)

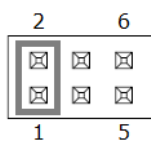

Pin	Signal	Pin	Signal
1	RI# [1]	2	Advantech define
3	Advantech define	4	+5V
5	+12V	6	Advantech define

## B.8 RJ45 + USB3.0 stack connector (LAN1\_USB12)

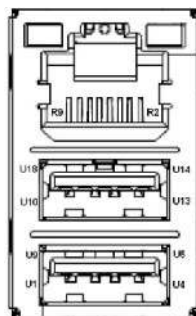

Pin	Signal	Pin	Signal
U1	VBUS (*)	U10	VBUS (*)
U2	D-_1	U11	D-_2
U3	D+_1	U12	D+_2
U4	GND	U13	GND
U5	RX-_1	U14	RX-_2
U6	RX+_1	U15	RX+_2
U7	GND	U16	GND
U8	TX-_1	U17	TX-_2
U9	TX+_1	U18	TX+_2

(\*) Depends on JUSBPWR2 Jump Setting

Pin	Signal	Pin	Signal
R2	MDI_0+	R6	MDI_2+
R3	MDI_0-	R7	MDI_2-
R4	MDI_1+	R8	MDI_3+
R5	MDI_1-	R9	MDI_3-

## B.9 USB Power selection header #2 (JUSBPWR2)



Pin	Signal
1	+V5_DUAL
2	Advantech define
3	+V5

## B.10 RJ45 + USB3.0 stack connector (LAN2\_USB34)

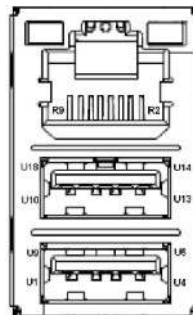

Pin	Signal	Pin	Signal
U1	VBUS (*)	U10	VBUS (*)
U2	D-_3	U11	D-_4
U3	D+_3	U12	D+_4
U4	GND	U13	GND
U5	RX-_3	U14	RX-_4
U6	RX+_3	U15	RX+_4
U7	GND	U16	GND
U8	TX-_3	U17	TX-_4
U9	TX+_3	U18	TX+_4

(\*) Depends on JUSBPWR2 Jump Setting

Pin	Signal	Pin	Signal
R2	MDI_0+	R6	MDI_2+
R3	MDI_0-	R7	MDI_2-
R4	MDI_1+	R8	MDI_3+
R5	MDI_1-	R9	MDI_3-

## B.11 HD Audio Interface (AUDIO1)

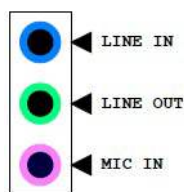

Pin	Signal
1	MIC IN
2	LINE OUT
3	LINE IN

\*Default only Mic-in, Line out.

## B.12 Volume adjust reserve jumper(VOL\_ADJ1)

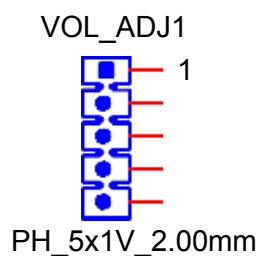

Pin	Signal	Pin	Signal
1	B_FRONT-OUT-L	4	C_FRONT-OUT-R
2	C_FRONT-OUT-L	5	B_FRONT-OUT-R
3	GND_A		

## B.13 Voltage selector for EDP1 connector (JEDP1)

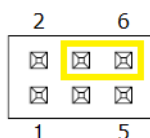

Pin	Signal	Pin	Signal
1	NC	2	+5V
3	+12V	4	EDP1 VDD
5	NC	6	+3.3V

## B.14 Front panel audio pin header (FPAUD1)

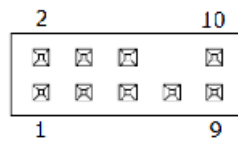

Pin	Signal	Pin	Signal
1	MIC IN-L	2	GND
3	MIC IN-R	4	FPAUD_DETECT#
5	LINE OUT-R	6	SENSE R1
7	SENSE	8	KEY
9	LINE OUT-L	10	SENSE R2

## B.15 HD Audio interface (SPDIF1)

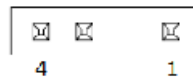

Pin	Signal
1	+5V
2	KEY
3	SPDIF OUT
4	GND

## B.16 EDP Backlight inverter power connector (INV1)



Pin	Signal
1	+12V
2	GND
3	BKL EN
4	BKL CTRL
5	+5V

## B.17 Embedded DisplayPort (EDP1)

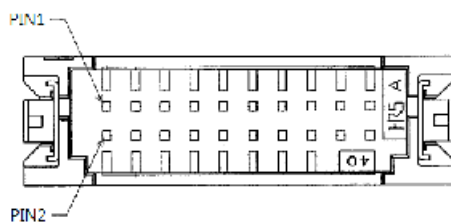

Pin	Signal	Pin	Signal
1	GND	2	GND
3	ML0-	4	NC
5	ML0+	6	NC
7	GND	8	NC
9	ML1-	10	GND

Pin	Signal	Pin	Signal
11	ML1+	12	AUX-
13	GND	14	AUX+
15	NC	16	GND
17	NC	18	Hot plug detect
19	EDP Power (*)	20	EDP Power (*)

(\*) Depends on JEDP1 Jump Setting

## B.18 LVDS VCON pull HI/pull Low selection (JLVDS\_VCON1)

Pin	Signal
1	+V3.3
2	Option
3	GND

## B.19 LVDS Panel Connector (LVDS1)

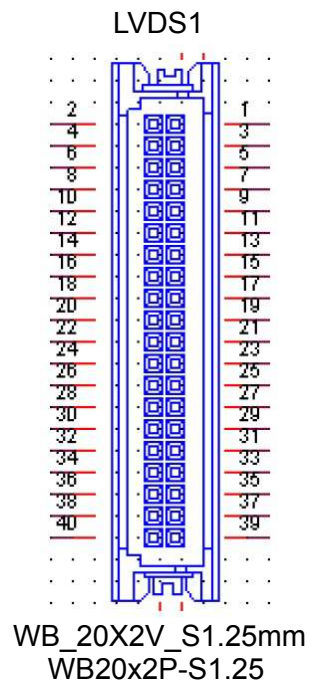

Pin	Signal	Pin	Signal
1	VDD	21	A2P
2	VDD	22	A6P
3	DET#	23	GND
4	GND	24	GND
5	VDD	25	CLK1N
6	VDD	26	CLK2N
7	A0N	27	CLK1P
8	A4N	28	CLK2P
9	A0P	29	GND
10	A4P	30	GND
11	GND	31	SCD
12	GND	32	SDD
13	A1N	33	GND
14	A5N	34	GND
15	A1P	35	A3N
16	A5P	36	A7N
17	GND	37	A3P
18	GND	38	A7P
19	A2N	39	ENBKL
20	A6N	40	VCON

## B.20 PCI Express x1 slot (PCIEX1\_1)

## B.21 USB Power selection header #1 (JUSBPWR1)



Pin	Signal
1	+V5_DUAL
2	Advantech define
3	+V5

## B.22 COM3 ~ COM6 box header (COM3456)

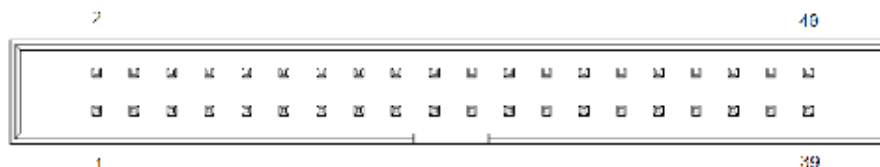

Pin	Signal	Pin	Signal
1	DCD# [3]	2	DSR# [3]
3	RXD [3]	4	RST# [3]
5	TXD [3]	6	CTS# [3]
7	DTR# [3]	8	RI# [3]
9	GND	10	GND
11	DCD# [4]	12	DSR# [4]
13	RXD [4]	14	RST# [4]
15	TXD [4]	16	CTS# [4]
17	DTR# [4]	18	RI# [4]
19	GND	20	GND
21	DCD# [5]	22	DSR# [5]
23	RXD [5]	24	RST# [5]
25	TXD [5]	26	CTS# [5]
27	DTR# [5]	28	RI# [5]
29	GND	30	GND
31	DCD# [6]	32	DSR# [6]
33	RXD [6]	34	RST# [6]
35	TXD [6]	36	CTS# [6]
37	DTR# [6]	38	RI# [6]
39	GND	40	GND

## B.23 COM7 ~ COM10 box header (COM78910)

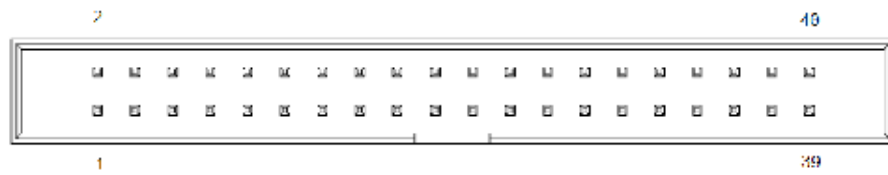

Pin	Signal	Pin	Signal
1	DCD# [7]	2	DSR# [7]
3	RXD [7]	4	RST# [7]
5	TXD [7]	6	CTS# [7]
7	DTR# [7]	8	RI# [7]
9	GND	10	GND
11	DCD# [8]	12	DSR# [8]
13	RXD [8]	14	RST# [8]
15	TXD [8]	16	CTS# [8]
17	DTR# [8]	18	RI# [8]
19	GND	20	GND
21	DCD# [9]	22	DSR# [9]
23	RXD [9]	24	RST# [9]
25	TXD [9]	26	CTS# [9]
27	DTR# [9]	28	RI# [9]
29	GND	30	GND
31	DCD# [10]	32	DSR# [10]
33	RXD [10]	34	RST# [10]
35	TXD [10]	36	CTS# [10]
37	DTR# [10]	38	RI# [10]
39	GND	40	GND



## B.24 COM7 RS232,RS422,RS485 selection pin header (JSETCOM7)

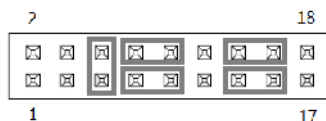

Pin	Signal	Pin	Signal
1	UART_SIN [7]	2	RXD_RS485
3	UART_SIN [7]	4	RXD_RS422
5	UART_SIN [7]	6	RXD_RS232
7	DCD7	8	SOUT [7]
9	COM7_DCD#	10	COM7_SOUT
11	COM7_TXD485-	12	COM7_RXD485+
13	SIN [7]	14	DTR [7]
15	COM7_SIN	16	COM7_DTR#
17	COM7_TXD485+	18	COM7_RXD485-

## B.25 Dual USB2.0 Port5/6 pin header (USB56)

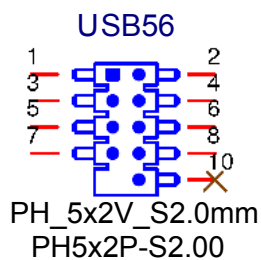

Pin	Signal	Pin	Signal
1	+USBHUBV12	2	+USBHUBV12
3	HUB_USB2P2-	4	HUB_USB2P1-
5	HUB_USB2P2+	6	HUB_USB2P1+
7	GND	8	GND
9	X	10	N/A

## B.26 System Fan #3 connector (SYSFAN3)

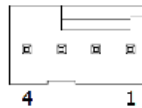

Pin	Signal
1	GND
2	SYSTEM FAN VCC
3	SYSTEM FAN SPEED
4	SYSTEM FAN PWM

## B.27 COM3 RS232,RS422,RS485 selection pin header (JSETCOM3)

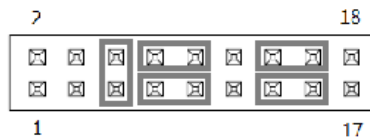

Pin	Signal	Pin	Signal
1	UART_SIN [3]	2	RXD_RS485
3	UART_SIN [3]	4	RXD_RS422
5	UART_SIN [3]	6	RXD_RS232
7	DCD3	8	SOUT [3]
9	COM3_DCD#	10	COM3_SOUT
11	COM3_TXD485-	12	COM3_RXD485+
13	SIN [3]	14	DTR [3]
15	COM3_SIN	16	COM3_DTR#
17	COM3_TXD485+	18	COM3_RXD485-

## B.28 16-bits General Purpose I/O pin header (GPIO1)

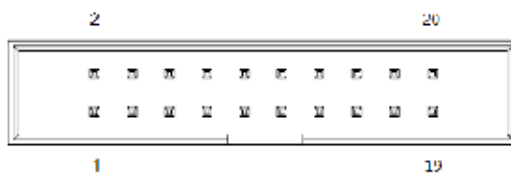

Pin	Signal	Pin	Signal
1	GPIO0	2	GPIO4
3	GPIO1	4	GPIO5
5	GPIO2	6	GPIO6
7	GPIO3	8	GPIO7
9	+V3.3_DUAL	10	GND

## B.29 Alarm Board/CMM Power Connector (VOLT1)



Pin	Signal
1	+5VSB
2	GND
3	GND
4	-5V
5	+5V
6	+3.3V
7	-12V
8	+12V

## B.30 Serial ATA interface connector (SATA1 / SATA2 / SATA3)

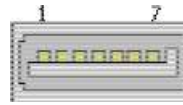

Pin	Signal
1	GND
2	TX+
3	TX-
4	GND
5	RX-
6	RX+
7	GND

## B.31 CMOS Mode selection (JCMOS1)



Pin	Signal
1	N/A
2	RTC RESET#
3	GND

## B.32 Clear RTC jumper (JRRTC1)

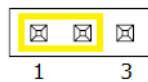

Pin	Signal
1	N/A
2	SRTC RESET#
3	GND

### B.33 Power switch/HDD LED/SMBus/Speaker pin header (JFP1)

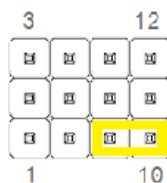

Pin	Signal	Pin	Signal
1	+5V	2	HDD LED+
3	Power Button+	4	SPK_P2
5	HDD LED-	6	Power Button-
7	SPK_P3	8	SMB_DATA
9	System Reset+	10	SPK_P4
11	SMB_CLK	12	System Reset-

### B.34 Power LED and keyboard lock pin header (JFP2)



Pin	Signal
1	LED Power
2	NC
3	GND
4	Keyboard Lock
5	GND

### B.35 SPI Pin Header (SPI\_CN1)

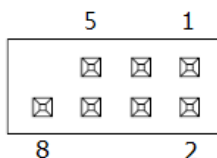

Pin	Signal	Pin	Signal
1	+3.3VSB	2	GND
3	CS#	4	SCLK
5	MISO	6	MOSI
		8	NC

## B.36 System Fan #2 connector (SYSFAN2)



Pin	Signal
1	GND
2	SYSTEM FAN VCC
3	SYSTEM FAN SPEED
4	SYSTEM FAN PWM

## B.37 Dual port USB3.0 header (USB1112)

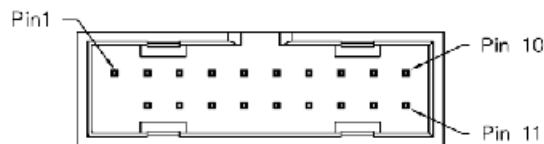

Pin	Signal	Pin	Signal
1	VBUS (*)	11	USBPCIE_z_P2+
2	USB3D1_z_RX-	12	USBPCIE_z_P2-
3	USB3D1_z_RX+	13	GND
4	GND	14	USB3D2_z_TX+
5	USB3D1_z_TX-	15	USB3D2_z_TX-
6	USB3D1_z_TX+	16	GND
7	GND	17	USB3D2_z_RX+
8	USBPCIE_z_P1-	18	USB3D2_z_RX-
9	USBPCIE_z_P1+	19	VBUS (*)
10	NC		

(\*) Depends on JUSBPWR1 Jump Setting

## B.38 ATX 24pin power connector (EATXPWR1)

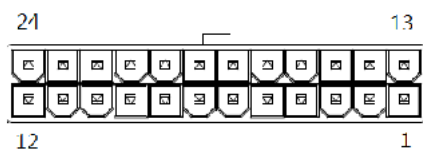

Pin	Signal	Pin	Signal
1	+3.3V	13	+3.3V
2	+3.3V	14	-12V
3	GND	15	GND
4	+5V	16	PSON#
5	GND	17	GND
6	+5V	18	GND
7	GND	19	GND
8	PWROK	20	-5V
9	+5VSB	21	+5V
10	+12V	22	+5V
11	+12V	23	+5V
12	+3.3V	24	GND

## B.39 Dual port USB3.0 header (USB1314)

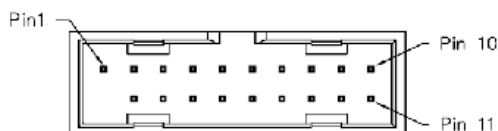

Pin	Signal	Pin	Signal
1	VBUS (*)	11	USBPCIE_z_P4+
2	USB3D3_z_RX-	12	USBPCIE_z_P4-
3	USB3D3_z_RX+	13	GND
4	GND	14	USB3D4_z_TX+
5	USB3D3_z_TX-	15	USB3D4_z_TX-
6	USB3D3_z_TX+	16	GND
7	GND	17	USB3D4_z_RX+
8	USBPCIE_z_P3-	18	USB3D4_z_RX-
9	USBPCIE_z_P3+	19	VBUS (*)
10	NC		

(\*) Depends on JUSBPWR1 Jump Setting

## B.40 CIR interface, Watchdog timer output and OBS beep (JIR1+JOBS1+JWDT1)



Pin	Signal	Pin	Signal
1	+5V	2	NC
3	NC	4	Watch Dog Reset# output
5	IRRX	6	System Reset input#
7	GND	8	SIO Warning Beep output
9	IRTX	10	SP1 Buzzer Beep input

## B.41 AT/ATX Mode selection (PSON1)

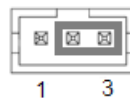

Pin	Signal
1	AT
2	+3.3V
3	ATX

## B.42 COM2 box header (COM2)



Pin	Signal	Pin	Signal
1	DCD# [2]	2	DSR# [2]
3	RXD [2]	4	RST# [2]
5	TXD [2]	6	CTS# [2]
7	DTR# [2]	8	RI# [2]
9	GND		



## B.43 COM2 RI# selection pin header (JSETCOM2\_V1)

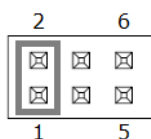

Pin	Signal	Pin	Signal
1	RI# [2]	2	Advantech define
3	Advantech define	4	+5V
5	+12V	6	Advantech define

## B.44 Case Open selection pin header (JCASEOP\_SW1)



Pin	Signal
1	Normal Open
2	Advantech define
3	Normal Close

## B.45 Case Open connector (JCASE1)



Pin	Signal
1	Case Open
2	GND

## B.46 LAN LED (LANLED1)



Pin	Signal	Pin	Signal
1	LAN1 ACTIVE	2	LAN2 ACTIVE
3	LAN1 LED PWR	4	LAN2 LED PWR
5	LAN1 LINK1000	6	LAN2 LINK1000
7	LAN1 LINK100	8	LAN2 LINK100
9	+3.3VSB		

## B.47 CPU FAN connector (CPUFAN1)



Pin	Signal
1	GND
2	CPU FAN VCC
3	CPU FAN SPEED
4	CPU FAN PWM

## B.48 SMBus connector from PCH (SMBUS1)



Pin	Signal
1	+5VSB
2	SMB CLK
3	SMB DAT
4	GND

## B.49 System Fan #1 connector (SYSFAN1)

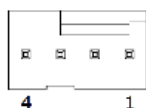

Pin	Signal
1	GND
2	SYSTEM FAN VCC
3	SYSTEM FAN SPEED
4	SYSTEM FAN PWM

## B.50 ATX 4 Pin main power connector (ATX12V1)

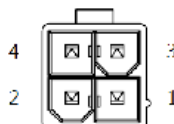

Pin	Signal
1	GND
2	GND
3	+12V
4	+12V

## B.51 Low pin count interface connector (LPC1)

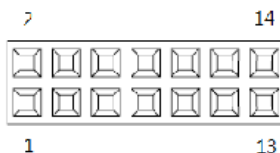

Pin	Signal	Pin	Signal
1	CLK (24MHz)	2	AD1
3	RESET#	4	AD0
5	FRAME#	6	+3.3V
7	AD3	8	GND
9	AD2	10	SMB CLK
11	SERIRQ	12	SMB DAT
13	+5VSB	14	+5V

## B.52 Jumper Setting List

	Description	Part Reference
1	USB VBUS selection for LAN1_USB12, LAN2_USB34, USB78910	JUSBPWR2
2	USB VBUS selection for USB56/ USB1112, USB1314	JUSBPWR1
3	Voltage selection for EDP1 connector	JEDP1
4	RTC / CMOS clear	JCMOS1
5	PWRBTN#/ RESET#/HDD LED/ Serial bus from HW monitor IC/Internal Buzzer / External Speaker header	JFP1
6	CIR interface, Watchdog timer output and OBS beep	JIR1+JOBS1+JWDT1
7	AT / ATX Mode selection	PSON1
8	COM3 RS232/ RS422/ RS485 selection pin header	JSETCOM3
9	Case open selection pin header	JCASEOP_SW1
10	COM1_RI# Pin selection pin header	JSETCOM1_V1
11	COM2_RI# Pin selection pin header	JSETCOM2_V1
12	COM7 RS232/ RS422/ RS485 selection pin header	JSETCOM7
13	LVDS VESA, JEIDA format selection pin header	JLVDS_VCON1

### B.52.1 USB VBUS selection for LAN1\_USB12, LAN2\_USB34, USB78910 (JUSBPWR2)

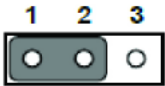
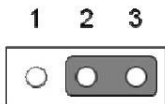
Function	Jumper Setting
Set USB VBUS as +5VSB (Default)	
Set USB VBUS as +5V	

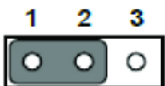
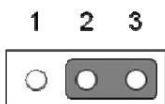

### B.52.2 USB VBUS selection for USB56, USB1112, USB1314 (JUSBPWR1)

Function	Jumper Setting
Set USB VBUS as +5VSB (Default)	
Set USB VBUS as +5V	

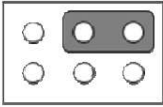
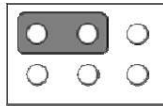
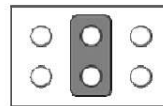
### B.52.3 Voltage selection for EDP1 connector (JEDP1)

Function	Jumper Setting
Jumper position for +3.3V (Default)	<div style="text-align: center;"> <p>2    4    6</p>  <p>1    3    5</p> </div>
Jumper position for +5V	<div style="text-align: center;"> <p>2    4    6</p>  <p>1    3    5</p> </div>
Jumper position for +12V	<div style="text-align: center;"> <p>2    4    6</p>  <p>1    3    5</p> </div>

### B.52.4 CMOS clear (JCMOS1)

Function	Jumper Setting
Keep CMOS Data (Default)	<div style="text-align: center;"> <p>1    2    3</p>  </div>
Clear CMOS Data	<div style="text-align: center;"> <p>1    2    3</p>  </div>

### B.52.5 PWRBTN#/ RESET#/HDD LED/ Serial bus from HW monitor IC/ Internal Buzzer /

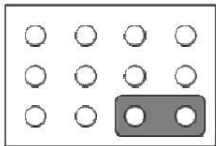
Function	Jumper Setting
Internal Buzzer (Default)	<div style="text-align: center;"> <p>3            12</p>  <p>1            7    10</p> </div>

## B.52.6 CIR interface, Watchdog timer output and OBS beep (JIR1+JOBS1+JWDT1)

Function	Jumper Setting
Watchdog Timer Output (4-6) (Default) OBS BEEP(8-10) (Default)	
Watchdog Timer Disable (2-4) OBS BEEP(8-10) (Default)	

## B.52.7 AT / ATX Mode selection (PSON1)

Function	Jumper Setting
ATX Mode (Default)	
ATX Mode	

### B.52.8 COM3 RS232, RS422, RS485 selection pin header (JSETCOM3)

Function	Jumper Setting
RS-232 Mode (Default) (5-6) (7-9) (8-10) (13-15) (14-16)	
RS-422 Mode (3-4) (9-11) (10-12) (15-17) (16-18)	
RS-485 Mode (1-2) (9-11) (10-12) (15-17) (16-18)	

### B.52.9 Case open selection pin header (JCASEOP\_SW1)

Function	Jumper Setting
Normal Close	
Normal Open (Default)	

## B.52.10 COM1\_RI# Pin RI# / 5V / 12V selection (JSETCOM1\_V1)

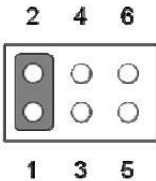
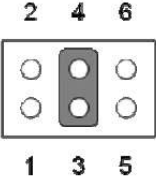
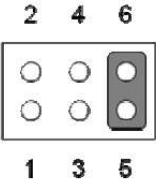
Function	Jumper Setting
Jumper position for RI# (Default)	
Jumper position for +5V	
Jumper position for +12V	

## B.52.11 COM2\_RI# Pin RI# / 5V / 12V selection (JSETCOM2\_V1)

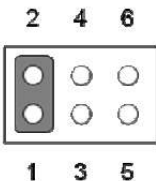
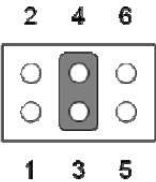
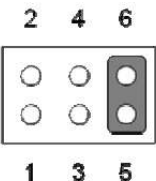
Function	Jumper Setting
Jumper position for RI# (Default)	
Jumper position for +5V	
Jumper position for +12V	



### B.52.12 COM7 RS232, RS422, RS485 selection pin header (JSETCOM7)

Function	Jumper Setting
RS-232 Mode (Default) (5-6) (7-9) (8-10) (13-15) (14-16)	
RS-422 Mode (3-4) (9-11) (10-12) (15-17) (16-18)	
RS-485 Mode (1-2) (9-11) (10-12) (15-17) (16-18)	

### B.52.13 LVDS VESA, JEIDA format selection pin header (JLVDS\_VCON1)

Function	Jumper Setting
JEIDA mode (HI=+3.3V)	
VESA mode (Low=0V) (Default)	

**ADVANTECH**

*Enabling an Intelligent Planet*

**[www.advantech.com](http://www.advantech.com)**

Please verify specifications before quoting. This guide is intended for reference purposes only.

All product specifications are subject to change without notice.

No part of this publication may be reproduced in any form or by any means, electronic, photocopying, recording or otherwise, without prior written permission of the publisher.

All brand and product names are trademarks or registered trademarks of their respective companies.

© Advantech Co., Ltd. 2016