

AIMS POWER™

www.aimscorp.net

Global LF Series Pure Sine Wave Inverter Charger User's Manual

Version 2.0

PICOGLF10KW48V240VS

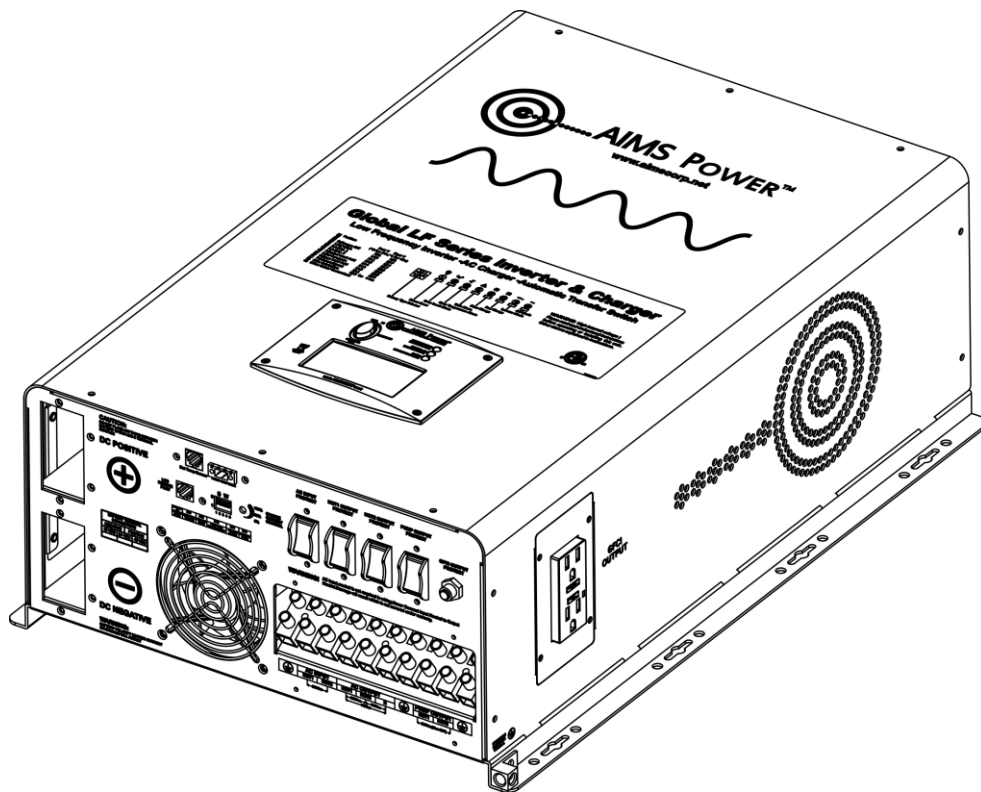



Table of Contents

1. Important Safety Information	- 3 -
1.1 General Safety Precautions	- 3 -
1.2 Precautions When Working with Batteries	- 4 -
2. Introduction	- 4 -
2.1 General Information	- 4 -
2.2 Application	- 4 -
2.3 Mechanical Drawing	- 5 -
2.4 Features	- 9 -
2.5 Electrical Performance	- 9 -
2.5.1 Invert	- 9 -
2.5.2 AC Charger	- 10 -
2.5.3 Transfer	- 13 -
2.5.4 Manual Frequency Switch	- 13 -
2.5.5 Power Saver	- 13 -
2.5.6 Protections	- 15 -
2.5.7 Remote Control	- 15 -
2.5.8 LED & LCD Indicator	- 16 -
2.5.9 Audible Alarm	- 17 -
2.5.10 FAN Operation	- 17 -
2.5.11 DIP Switches	- 18 -
2.5.12 Other Features	- 19 -
3. Installation	- 21 -
3.1 Location	- 21 -
3.2 DC Wiring	- 21 -
3.3 AC Wiring	- 22 -
3.4 Grounding	- 23 -
3.5 Install Flange	- 24 -
4. Troubleshooting Guide	- 25 -
5. Warranty	- 27 -
Appendix 1	- 28 -

1. Important Safety Information

 WARNING!	Before using the Inverter read and save the safety instructions.
	All wiring must follow the National Electric Code, The Canadian Electrical Code Part 1, Provincial or other codes in effect at the time of installation, regardless of suggestions in this manual. All wires should be copper conductors.
	This manual contains important instructions for Models 8KW & 12KW to be followed during installation and maintenance of the inverter.
	WARNING To reduce the risk of fire, do not connect to an ac load center having multiwire branch circuits connected.

1.1 General Safety Precautions

1-1-1. Do not expose the Inverter to rain, snow, spray, bilge or dust. To reduce risk of hazard, do not cover or obstruct the ventilation openings. Do not install the Inverter in a zero-clearance compartment.

Overheating may result. Allow at least 12 inches of clearance around the inverter for air flow. Make sure that the air can circulate freely around the unit. A minimum air flow of 145CFM is required.

1-1-2. To avoid risk of fire and electronic shock, make sure that the existing wiring is in good electrical condition and that the wire is not undersized. Do not operate the Inverter with damaged or substandard wiring.

1-1-3. This equipment contains components which may produce arcs and/or sparks. To prevent fire and/or explosion do not install in compartments containing batteries or flammable materials or in a location which requires ignition protected equipment. This includes any space containing gasoline-powered machinery, fuel tanks, joints, fittings, or other connections between components of the fuel system.

See Warranty for instructions on obtaining service.

1-1-4. Do not disassemble the Inverter/Charger. It contains no user-serviceable parts. Attempting to service the Inverter/Charger yourself may result in electrical shock or fire. Internal capacitors remain charged after all power is disconnected.

1-1-5. To reduce the risk of electrical shock, disconnect both AC and DC power from the Inverter/Charger before attempting any maintenance or cleaning. Turning off controls will not reduce this risk.

1-1-6. A fuse or breaker must be installed. Disconnect shall be rated to handle the input power requirement on AC or DC side. Please install disconnect on the input power side for AC and DC.

CAUTION: Equipment damage

The output side of the inverter's AC wiring should at no time be connected to public power or a generator. This condition is far worse than a short circuit. If the unit survives this condition, it will shut down until corrections are made.

Installation should ensure that the inverter's AC output is, at no time, connected to its AC input.

Warning: Limitations of Use

SPECIFICALLY NOTE THAT THE GLOBAL LF INVERTER/CHARGER SHOULD NOT BE USED IN CONNECTION WITH LIFE SUPPORT SYSTEMS OR OTHER SENSITIVE MEDICAL EQUIPMENT OR DEVICES (CPAP/BPAP OK).

1.2 Precautions When Working with Batteries

1-2-1. If battery acid contacts skin or clothing, wash immediately with soap and water. If acid enters eye, immediately flood eye with running cold water and seek medical attention immediately.

1-2-2. Never smoke or allow a spark or flame in the vicinity of a battery or engine.

1-2-3. Do not drop a metal tool on the battery. The resulting spark or short-circuit on the battery may cause an explosion.

1-2-4. Remove personal metal items such as rings, bracelets, necklaces, and watches when working with a lead-acid battery. A lead-acid battery produces a short-circuit current high enough to weld a ring or the like to metal, causing a severe burn.

1-2-5. To reduce the risk of injury, charge only deep-cycle lead acid, lead antimony, lead calcium gel cell, absorbed mat, or NiCad/NiFe type rechargeable batteries. Other types of batteries may burst, causing personal injury and damage.

2. Introduction

2.1 General Information

The Global LF Series Pure Sine Wave Inverter is a combination of an inverter, battery charger and AC auto-transfer switch into one complete system with a peak conversion efficiency of 88%.

It is packed with unique features and is one of the most advanced inverter/chargers on the market today.

It features power factor corrected, sophisticated multi-stage charging and pure sine wave output with unprecedentedly high surge capability to meet demanding power needs of inductive loads without damaging the equipment.

For the regular model, when utility AC power cuts off (or falls out of acceptable range), the transfer relay is de-energized and the load is automatically transferred to the Inverter output. Once the qualified AC utility is restored, the relay is energized and the load is automatically reconnected to AC utility.

The Global LF Series Inverter is equipped with a powerful charger.

The overload capacity is 300% of continuous output for up to 20 seconds to reliably support tools and equipment longer

Another important feature is setting the battery priority via a DIP switch, and can be easily customized which helps to extract maximum power from the battery in renewable energy systems.

Thus, the Global LF Series Pure Sine Wave Inverter is suitable for Renewable energy systems, Utility, RV, Marine and Emergency appliances.

To get the most out of the power inverter, it must be installed, used and maintained properly. Please read the instructions in this manual before installing and operating.

2.2 Application

Power tools—circular saws, drills, grinders, sanders, buffers, weed and hedge trimmers, air compressors.

Office equipment – computers, printers, monitors, facsimile machines, scanners.

Household items – vacuum cleaners, fans, fluorescent and incandescent lights, shavers, sewing machines.

Kitchen appliances – coffee makers, blenders, ice makers, toasters.

Industrial equipment – metal halide lamp, high – pressure sodium lamp.

Home entertainment electronics – TV, DVRs, video games, stereos, musical instruments, and satellite.

2.3 Mechanical Drawing

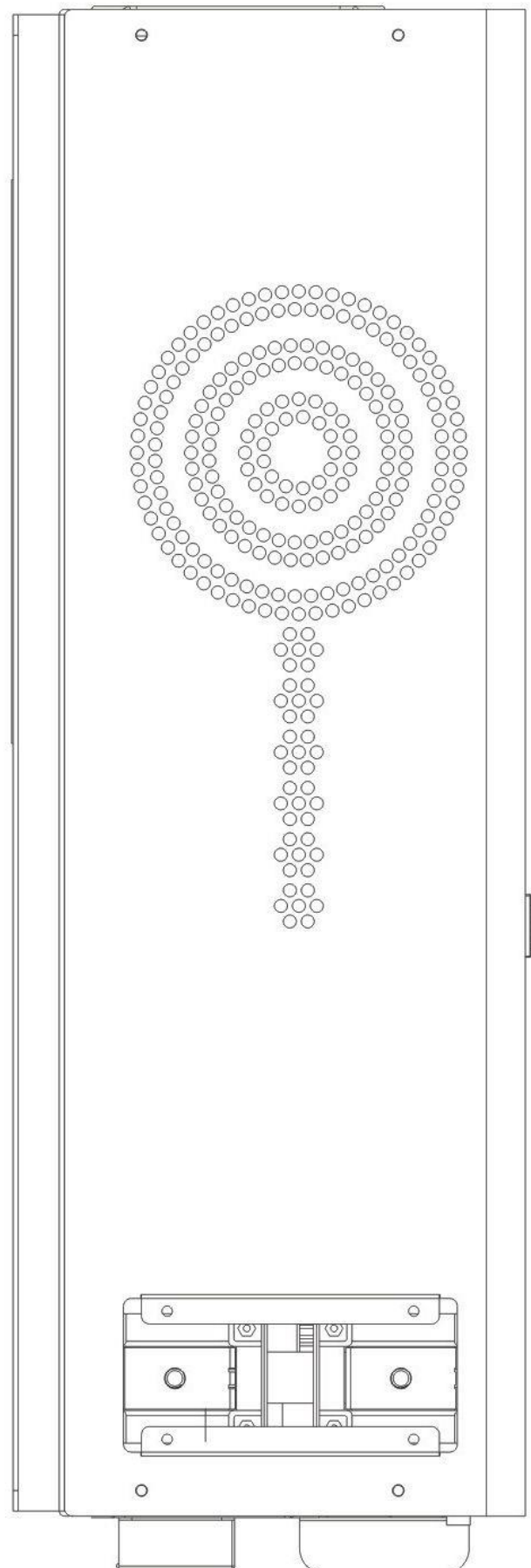
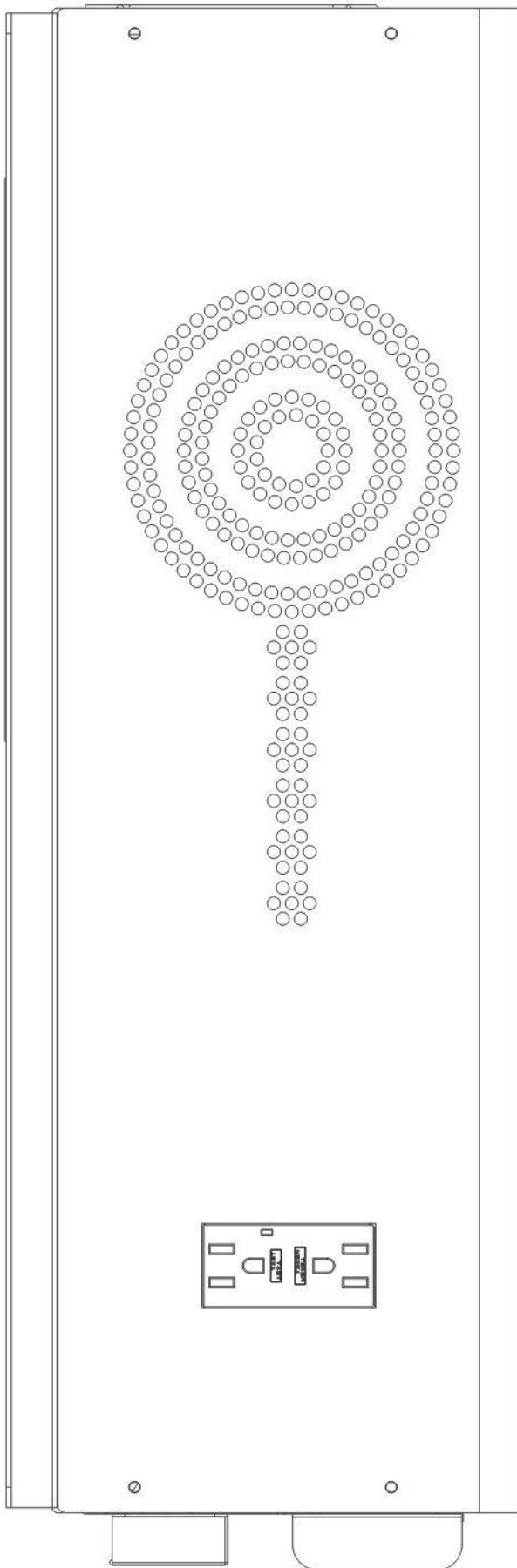

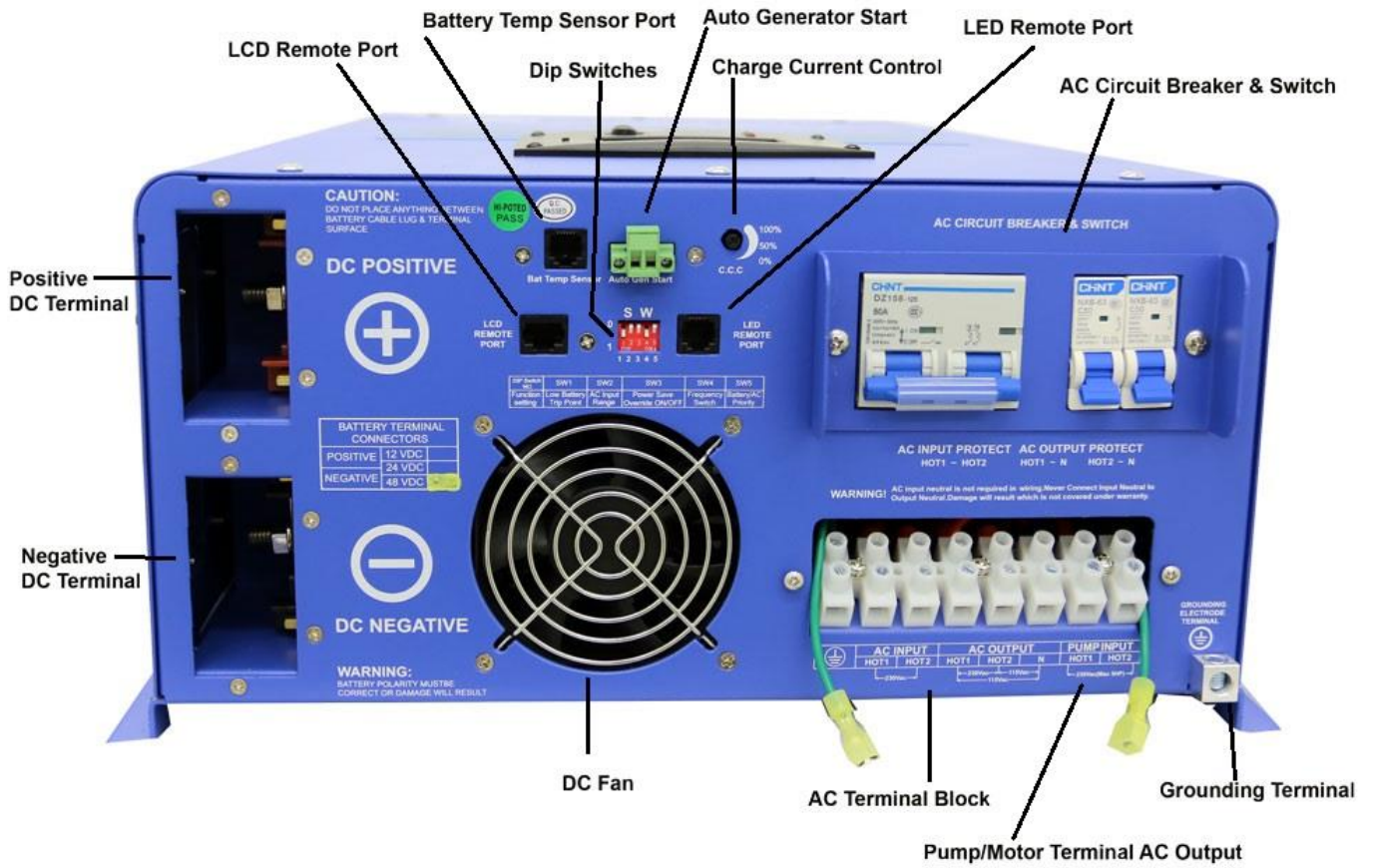

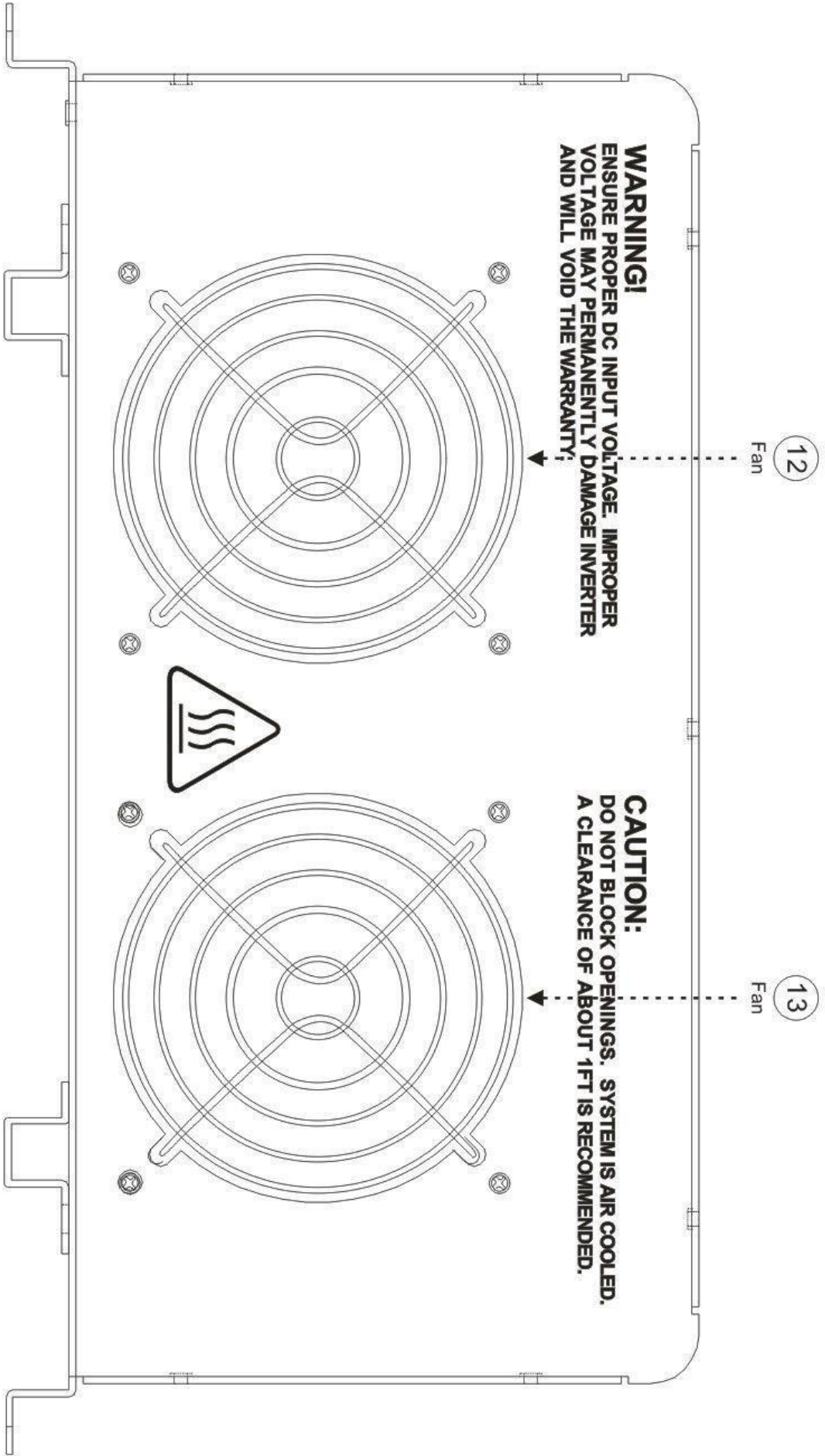

2.4 Features

- ⊙ High overload ability up to 300% of rated power (20 sec)
- ⊙ Low quiescent current, low power “Power Saving Mode” to conserve energy
- ⊙ Automatic Generator Start
- ⊙ Battery Temperature Sensing for increased charging precision
- ⊙ 4-step intelligent battery charger, PFC (Power Factor Correction) for charger
- ⊙ 8 pre-set battery type selector switch plus de-sulphation for totally flat batteries
- ⊙ Powerful charge rate of up to 105Amp, selectable from 0%-100%
- ⊙ 10 ms typical transfer time between battery and AC, guarantees power continuity
- ⊙ Smart remote control (optional)
- ⊙ 15s delay before transfer when AC resumes, extra protection for loads when used with generator
- ⊙ Allows start up and through power with depleted batteries
- ⊙ Multiple controlled cooling fans
- ⊙ Extensive protections against various harsh environments
- ⊙ 13VDC battery recovery point, dedicated for renewable energy systems

2.5 Electrical Performance

2.5.1 Invert

Topology

The Global LF inverter/charger is built according to the following topology.

Invert: Full Bridge Topology.

Charge: Isolated Boost Topology.

It works bi-directionally: in one direction it converts DC power from the battery to AC power (Inverter Mode) and in the other direction it converts external AC power to DC power to charge the batteries (AC Mode). The same power components are used in both directions, resulting in high-energy transfer efficiency with fewer components.

Please note that the inverter/charger can only work in one direction at one time (i.e. it cannot work as an inverter and as a charger at the same time).

When operating in inverter mode, the direct current (DC) that enters the inverter from the batteries is filtered by a large input capacitor and switched “On” and “Off” by the Metal Oxide Silicon Field Effect Transistors (MOSFET) at a rate of 50 Hz or 60Hz, in this step the DC is converted to low voltage synthesized sine wave AC using an H-bridge configuration and high frequency PWM (Pulse Width Modulation) technique. It is then directed into the transformer which steps the low AC voltage up to 230 or 120 volts.

The unit has a 16bit, 4.9MHZ microprocessor to control the output voltage and frequency as the DC input voltage and/or output load varies.

Because of high efficiency MOSFETs and the heavy transformers, it outputs PURE SINE WAVE AC with an average THD of 10% (min 3%, max 20% under full linear loads) depending on load connected and battery voltage. The peak DC to AC conversion efficiency of the Global LF series is >88%.



Don't parallel the AC output of the inverters to increase power capacity as they have no stacking functionality.

Overload Capacity

The Global LF series inverters have high overload capacities, making it ideal to handle demanding loads.

- 1 For $110\% < \text{Load} < 125\% (\pm 10\%)$, no audible alarm for 14 minutes, beeps 0.5s every 1s in the 15th minute, and Fault (Turn off) after the 15th minute.
- 2 For $125\% < \text{Load} < 150\% (\pm 10\%)$, beeps 0.5s every 1s and Fault (Turn off) after 1 minute.
- 3 For $300\% \geq \text{Load} > 150\% (\pm 10\%)$, beeps 0.5s every 1s and Fault (Turn off) after 20s.

Caution:

After the inverter is switched on, it takes time for it to self diagnose and ready to deliver full power. Hence, always switch on the load(s) after a few seconds of switching on the inverter. Avoid switching on the inverter with the load already switched on. This may prematurely trigger the overload protection. When a load is switched on, it may require initial higher power surge to start. Hence, if multiple loads are being powered, they should be switched on one by one so that the inverter is not overloaded by the higher starting surge if all the loads are switched on at once.

2.5.2 AC Charger

The Global LF Series is equipped with an active PFC (Power Factor Corrected) multistage battery charger. The PFC feature is used to control the amount of power used to charge the batteries in order to obtain a power factor as close as possible to 1.

Unlike other inverters whose max charging current decreases according to the input AC voltage, Global LF series inverter charger is able to output max current as long as the input AC voltage is in the range of 164-243VAC (95-127VAC for 120V model), and AC freq is in the range of 48-54Hz(58-64Hz for 60Hz model).

The Global LF series inverter has a very rapid charge current available, and the max charge current can be adjusted from 0%-100% via a liner switch to the right of the battery type selector. This will be helpful if you are using our powerful charger on a small capacity battery bank. Fortunately, the liner switch can effectively reduce the max charging current to 20% of its peak.

Choosing “0” in the battery type selector will disable the charging function.



Caution:

Turn the charge current control switch gently to avoid breakage due to over-turning.

To reduce the risk of fire, only connect to an AC circuit that can provide 150 percent of the inverter’s size.

There are 3 charging stages:

Bulk Charging: This is the initial stage of charging. While Bulk Charging, the charger supplies the battery with controlled constant current. The charger will remain in Bulk charge until the Absorption charge voltage (determined by the Battery Type selection) is achieved.

A software timer will measure the time from A/C start until the battery charger reaches 0.3V below the boost voltage, then take this time as T0 and $T0 \times 10 = T1$.

Absorb Charging: This is the second charging stage and begins after the absorb voltage has been reached. Absorb Charging provides the batteries with a constant voltage and reduces the DC charging current in order to maintain the absorb voltage setting.

In this period, the inverter will start a T1 timer; the charger will keep the boost voltage in Boost CV mode until the T1 timer has run out. Then drop the voltage down to the float voltage. The timer has a minimum time of 1 hour and a maximum time of 12 hours.

Float Charging: The third charging stage occurs at the end of the Absorb Charging time. While Float charging, the charge voltage is reduced to the float charge voltage (determined by the Battery Type selection*). In this stage, the batteries are kept fully charged and ready if needed by the inverter. If the A/C is reconnected or the battery voltage drops below 12Vdc/24Vdc, the charger will restart the above cycle.

If the charge maintains the float state for 10 days, the charger will deliberately reset the cycle to protect the battery.

Battery Charging Processes

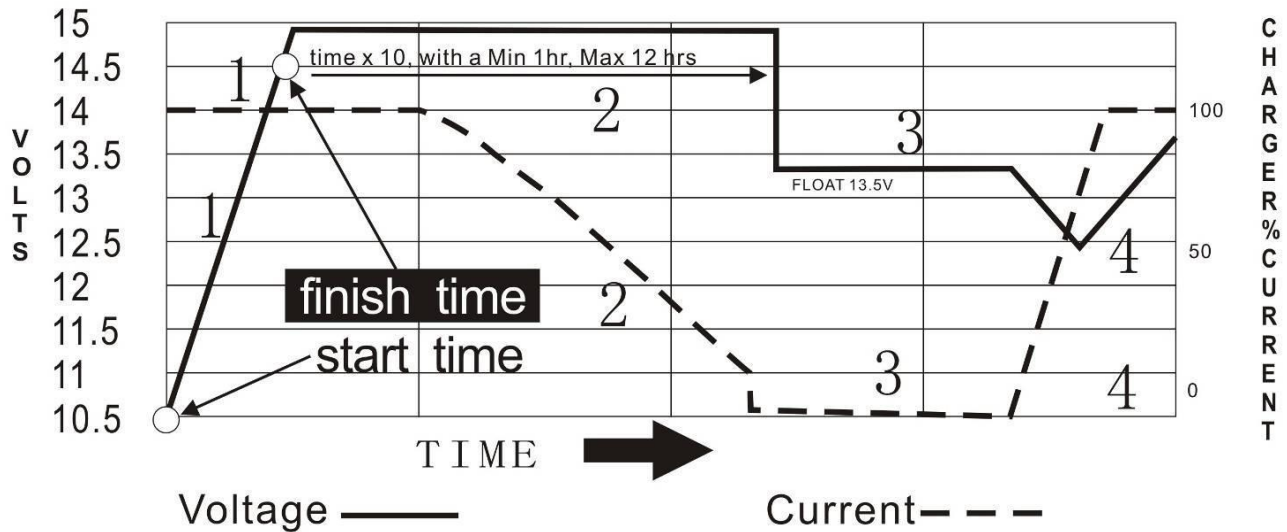

THE NEW BATTERY CHARGERS AND BOOSTERS OFFER THE FASTEST CHARGE RATE CURRENTLY AVAILABLE

STEP 1= Bulk Charge (Constant Current)
STEP 3= Float Voltage

STEP 2 = Absorption (Constant Voltage)
STEP 4 = RESET TO STEP 1

*2 FOR 24 VOLTS
*4 FOR 48 VOLTS

ADJUSTABLE TIME DEPENDING ON BATTERY BANK CAPACITY

Battery type selector

Switch setting	Description	Boost / Vdc	Float / Vdc
0	Charger Off		
1	Gel USA	14.0	13.7
2	AGM 1	14.1	13.4
3	AGM 2	14.6	13.7
4	Sealed lead acid	14.4	13.6
5	Gel EURO	14.4	13.8
6	Open lead acid	14.8	13.8
7	Calcium	15.1	13.6
8	De-Sulphation	15.5 (4 Hours then Off)	
9	Not used		

Above figures based on 12Vdc models, *2 for 24Vdc, *4 for 48Vdc.

De-sulphation

The de-sulphation cycle, switch position 8, is marked in red because this is a very dangerous setting if you do not know what you are doing. Before attempting to use this cycle you must clearly understand what it does and when and how you would use it.

What causes sulphation? This can occur with infrequent use of the batteries, or if the batteries have been discharged so low that they will not accept a charge. This cycle is a very high voltage charge cycle designed to try to break down the sulphated crust that is preventing the plates from taking a charge, thus allowing the plates to clean up and accept a charge once again.

Charging depleted batteries

The Global LF series inverter allows start up and through power with depleted batteries.

For 12VDC models: after the battery voltage goes below 10V and the power switch is kept in the "ON" position and the inverter stays connected to the battery and the battery voltage doesn't drop below 2V, the inverter will be able to charge the battery once qualified AC inputs are present.

Before the battery voltage goes below 9VDC, the charging can be activated when the switch is turned to "OFF", then to "ON".

When the voltage goes below 9VDC, and you accidentally turn the switch to OFF or disconnect the inverter from the battery, the inverter will not be able to charge the battery once again, because the CPU loses memory during this process.

Charging current for each model

Model	Current
PICOGLF10KW48V240VS	100 A +/- 5A

The charging capacity will go to peak charge rate in about 3 seconds. This may cause a generator to drop frequency, making the inverter transfer to battery mode.

It is suggested to gradually put the charging load on the generator by switching the charging switch from min to max. Together with the 15s switch delay our inverter gives the generator enough time to spin up. This will depend on the size of the generator and rate of charge.

2.5.3 Transfer

While in the Standby Mode, the AC input is continually monitored. Whenever AC power falls below the VAC Trip voltage (154 VAC, default setting for 230VAC,90VAC for 120VAC), the inverter automatically transfers back to the Inverter Mode with minimum interruption to your appliances - as long as the inverter is turned on. The transfer from Standby mode to Inverter mode occurs in approximately 10 milliseconds. And it is the same time from Inverter mode to Standby mode.

Though it is not designed as a computer UPS system, this transfer time is usually fast enough to keep your equipment powered up.

There is a 15-second delay from the time the inverter senses that continuously qualified AC is present at the input terminals to when the transfer is made. This delay is built in to provide time for a generator to spin-up to a stable voltage and avoid relay chattering. The inverter will not transfer to generator until it has locked onto the generator's output. This delay is also designed to avoid frequent switching when input utility is unstable.

2.5.4 Manual Frequency Switch

All our Global LF line of inverters have a 50/60 Hz selector switch. When the inverter is turned off and shore power is not present, the frequency of the inverter may be selected to be 50 or 60 Hz.

2.5.5 Power Saver

There are 2 different working statuses for our Global LF inverter: "Power On" and "Power Off". When the power switch is in "Unit Off" position, the inverter is powered off.

When the power switch is turned to either of “Power Saver Auto” or “Power Saver Off”, the inverter is powered on.

Power saver function is designed to conserve battery power when AC power is not or rarely required by the loads.

In this mode, the inverter pulses the AC output looking for an AC load (i.e., electrical appliance). Whenever an AC load (greater than 25 watts) is turned on, the inverter recognizes the need for power and automatically starts inverting and output goes to full voltage. When there is no load (or less than 25 watts) detected, the inverter automatically goes back into search mode to minimize energy consumption from the battery bank. In “Power Saver On” mode, the inverter will draw power mainly in sensing moments, thus the idle consumption is significantly reduced.

The inverter is factory defaulted to detect a load for 250ms every 3 seconds. This cycle can be customized to be turned “OFF” via dipswitch # 3.

Note: The minimum power of a load to take inverter out of sleep mode (Power Saver On) is 25 Watts.

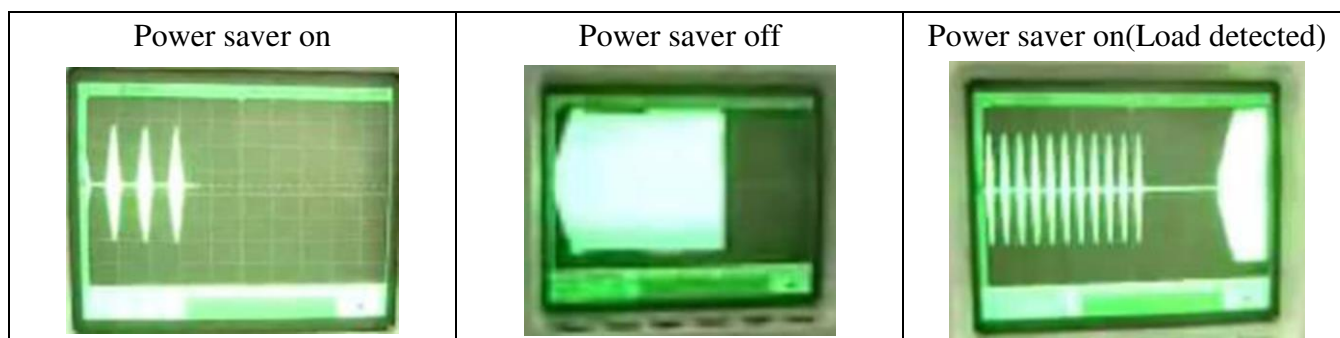

The Global LF Series is designed with extraordinarily low idle power consumption of 0.8-1.8% of its rated power.

Global LF Series Idle Power Consumption (in Watts)

Model NO	Power Saver Off	Power Saver On (3Secs)
PICOGLF10KW48V240VS	150	35

When in the search sense mode, the green power LED will blink and the inverter will make a ticking sound. At full output voltage, the green power LED will light steadily and the inverter will make a steady humming sound. When the inverter is used as an “uninterruptible” power supply the search sense mode or “Power Saver On” function should be defeated.

Exceptions

Some devices when scanned by the load sensor cannot be detected. Small fluorescent lights are the most common example. (Try altering the plug polarity by turning the plug over.) Some computers and sophisticated electronics have power supplies that do not present a load until line voltage is available. When this occurs, each unit waits for the other to begin. To drive these loads either a small companion load must be used to bring the inverter out of its search mode, or the inverter may be programmed to remain at full output voltage (Power On mode).

2.5.6 Protections

The Global LF series inverter is equipped with extensive protections against various harsh situations/faults.

These protections include:

AC Input over voltage protection/AC Input low voltage protection

Low battery alarm/High battery alarm

Over temperature protection/Over load protection

Short Circuit protection (1s after fault)

Back feeding protection

When over temperature / over load occur, after the fault is cleared, the master switch has to be reset to restart the inverter.

The low battery voltage trip point can be customized from a defaulted value of 10VDC to 10.5VDC thru SW1 on the DIP switch.

The inverter will go to over temp protection when the heat sink temp. $\geq 105^{\circ}\text{C}$ (221°F), and go to Fault (shutdown Output) after 30 seconds. The switch has to be reset to activate the inverter.

The Global LF series Inverter has back feeding protection which avoids presenting an AC voltage on the AC input terminal in inverter mode.

After the reason for the fault is cleared, the inverter must be reset to start working.

Peak Current 50 Amp , duration 1 Second of peak and the 3 cycle RMS value is 100Vac.

2.5.7 Remote Control

Apart from the switch panel on the front (or top) of the inverter,

an extra switch panel connected to the RJ11 port at the DC side of the inverter thru a standard telephone cable can also control the operation of the inverter (sold separately Part # REMOTELFLED).

If an extra switch panel is connected to the inverter via “remote control port”, together with the panel on the inverter case, the two panels will be connected and operated in parallel.

Whichever first switches from “Off” to “Power saver off”

or

“Power saver on”, it will power the inverter on.

If the commands from the two panels conflict, the inverter will operate according to the following priority:

Power saver on> Power saver off> Power off

Only when both panels are turned to the “Unit Off” position, will the inverter be powered off.

The Max length of the cable is 10 meters.

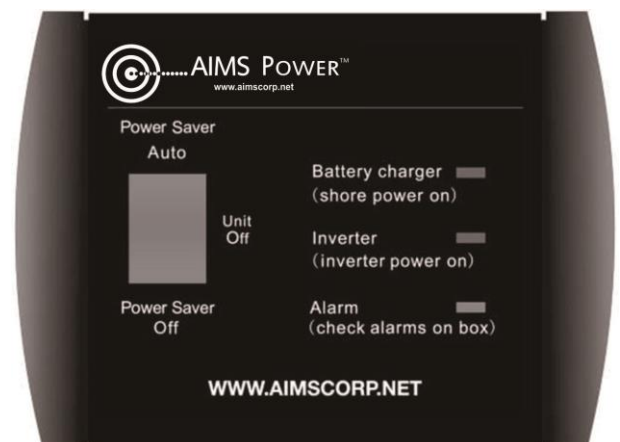

WARNING

Never cut the telephone cable when the cable is attached to inverter and battery is connected to the inverter. Even if the inverter is turned off, it will damage the remote PCB inside if the cable is short circuited during cutting.

2.5.8 LED & LCD Indicator

Global LF Series Inverter & Charger

Low Frequency Inverter -AC Charger -Automatic Transfer Switch

BATT. TYPE & CHG. VOLTAGE	Position	Fast V	Float V
		(*2 for 24v; *4 for 48v)	
0.Charge Off		N/A	N/A
1.Gel U.S.A		14.0	13.7
2.A.G.M. 1		14.1	13.4
3.A.G.M. 2		14.6	13.7
4.Sealed Lead Acid		14.4	13.6
5.Gel European		14.4	13.8
6.Open Lead Acid		14.8	13.8
7.Calcium (Open)		15.1	13.6
8.De Sulphation		15.5 for 4 hrs	
9.Not Used / Customized			

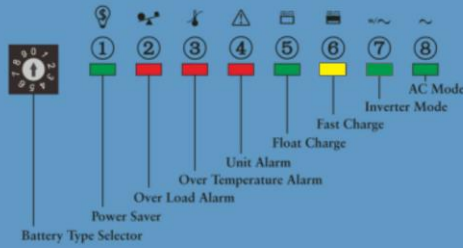

WARNING: High internal voltage !
Please read and understand instructions before operating or installing this unit. Other alarms explained in instructions.



SHORE POWER ON	GREEN LED lit in AC Mode
INVERTER ON	GREEN LED lit in Inverter Mode
FAST CHARGE	YELLOW LED lit in Fast Charging Mode
FLOAT CHARGE	GREEN LED lit in Float Charging Mode
OVER TEMP TRIP	RED LED lit in Over Temperature
OVER LOAD TRIP	RED LED lit in Over Load
POWER SAVER ON	GREEN LED lit in Power Saver Mode (Power Saver Load $\leq 25W$)

The LCD remote will display the following content:

Function Description Drawing

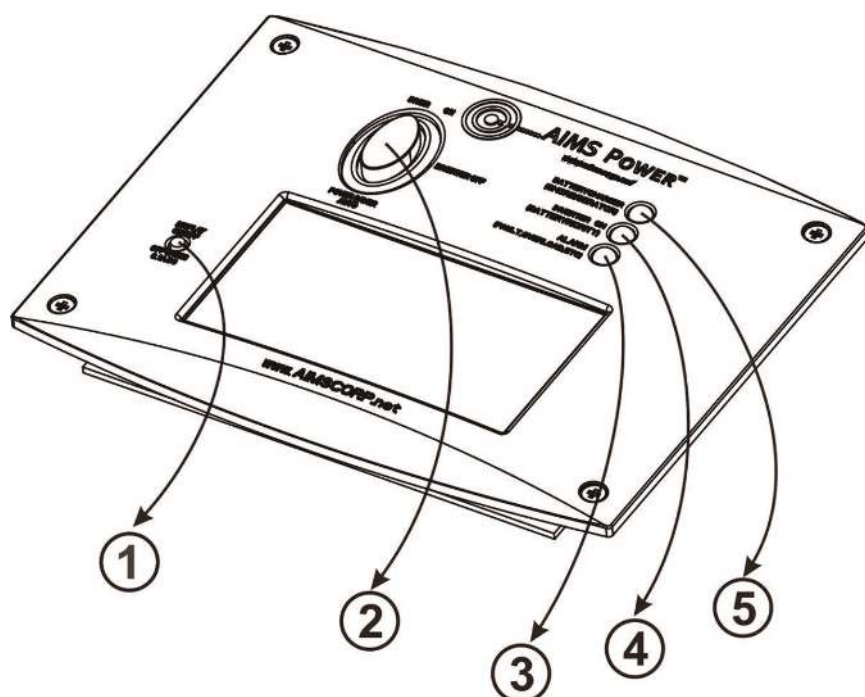

- ① Display ON&OFF
- ② Power Switch ON&OFF
- ③ Alarm LED
- ④ Inverter LED
- ⑤ Battery Charger LED

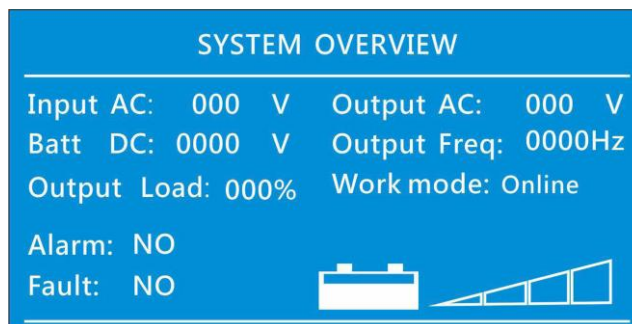

Greeting message of “Welcome to AIMS POWER”

AC Status & Input Voltage

“AC: abnormal” is displayed when AC input is not qualified.

Output Voltage/Frequency and Output Current (in percentage) in Inverter mode Battery voltage

Note:

When the inverter is in Battery Priority mode, finishes a complete charging cycle and switches to inverter mode “AC: abnormal” will be displayed.

In AC mode, the LCD will not display the status of the AC load.

2.5.9 Audible Alarm

Battery Voltage Low	Inverter green LED lit, and the buzzer beeps 0.5s every 5s.
Battery Voltage High	Inverter green LED lit, and the buzzer beeps 0.5s every 1s and Fault after 60s.
Inverter Mode Over-Load	(1)110% < load < 125%(±10%), No audible alarm in 14 minutes, Beeps 0.5s every 1s in 15th minute and Fault after 15 minutes; (2)125% < load < 150%(±10%), Beeps 0.5s every 1s and Fault after 60s; (3) Load > 150%(±10%), Beeps 0.5s every 1s and Fault after 20s;
Over Temperature	Heat sink temp. ≥105°C (221°F), Over temp red LED Lighting, beeps 0.5s every 1s;

2.5.10 FAN Operation

All models (6KW and up) have 2 DC fans.

12KW also has 1 AC fan that will turn on when there is AC output.

When the inverter is in power saver mode, the AC fan will work from time to time in response to the pulse sent by the inverter in power saver mode.

The DC fans are variable speed and work as follows:

Condition	Enter Condition	Leave condition	Speed
HEAT SINK TEMPERATURE	$T \leq 60^{\circ}\text{C} (140^{\circ}\text{F})$	$T > 65^{\circ}\text{C} (149^{\circ}\text{F})$	OFF
	$65^{\circ}\text{C} (149^{\circ}\text{F}) \leq T < 85^{\circ}\text{C} (185^{\circ}\text{F})$	$T \leq 60^{\circ}\text{C} (140^{\circ}\text{F})$ or $T \geq 85^{\circ}\text{C} (185^{\circ}\text{F})$	50%
	$T > 85^{\circ}\text{C} (185^{\circ}\text{F})$	$T \leq 80^{\circ}\text{C} (176^{\circ}\text{F})$	100%
CHARGER CURRENT	$I \leq 15\%$	$I \geq 20\%$	OFF
	$20\% < I \leq 50\% \text{Max}$	$I \leq 15\%$ or $I > 50\% \text{Max}$	50%
	$I > 50\% \text{Max}$	$I \leq 40\% \text{Max}$	100%
LOAD Percentage (INV MODE)	Load < 30%	Load ≥ 30%	OFF
	$30\% \leq \text{Load} < 50\%$	Load ≤ 20% or Load ≥ 50%	50%
	Load ≥ 50%	Load ≤ 40%	100%

Allow at least 12 inches of clearance around the inverter for air flow. Make sure that the air can circulate freely around the unit.

Fan noise level <60db at a distance of 3 feet.

2.5.11 DIP Switches

On the DC end of inverter, there are 5 DIP switches which enable users to customize the performance of the device.

Switch NO	Switch Function	Position: 0	Position: 1
SW1(Utility Priority)	Low Battery Trip Point	10.0VDC	10.5VDC
SW1(Battery Priority)		10.5VDC	11.5VDC
SW2(230V)	AC Input Range	184-253VAC	154-264VAC(40Hz+)
SW2(120V)	AC Input Range	100-135VAC	90-135VAC(40Hz+)
SW3	Power Save Override	Inverter Off	Saver On 3 sec
SW4	Frequency Switch	50Hz	60Hz
SW5	Battery/AC Priority	AC Priority	Battery Priority

Low Battery Trip Point(SW1):

Deep discharge of the lead acid battery leads to high losses in capacity and early aging. In different applications a different low voltage disconnection level is preferred. For example, for solar applications, user may intend to have less DOD to prolong the battery life cycle. While for mobile applications users may intend to have more DOD to reduce battery capacity and on-board weight.

For 12VDC models, when the inverter is in utility priority mode (SW5 at “0”), Low Battery Trip Point is selectable at 10.0/10.5VDC. It can be customized to 10.5/11.5VDC via SW5. This is to prevent batteries from over-discharging while there is only a small load applied on the inverter.

*2 for 24VDC, *4 for 48VDC

AC Input Range(SW2):

There are different acceptable AC input ranges for different kinds of loads.

For some relatively sensitive electronic devices, a narrow input range of 184-253VAC (100-135V for 120VAC model) is required to protect them.

While for some resistive loads which work in a wide voltage range, the input AC range can be customized to 154-264VAC (90-135V for 120VAC model), this helps to power loads with the most AC input power without frequent switches to the battery bank.

To force the inverter to accept dirty power from a generator, when the SW2 is switched to position “1”, the inverter will bypass an AC input with a wider voltage and frequency (40Hz plus for 50Hz/60Hz).

Accordingly, the AC charger will also work in a wider voltage and frequency range (43Hz plus for 50Hz/60Hz). This will avoid frequent switches between inverter mode and AC input mode. Some sensitive devices will suffer from the wide AC input range and damage may occur.

Power Save Override ON/OFF (SW3):

Under the Battery Priority Mode (SW5 in position “1”), the inverter can be switched between two modes: Power Saver Mode (SW3 in position “1”) and Unit Off Charging Mode (SW3 in position “0”). The power Switch should be in “Power saver on” position all the time for using these functions.

In Power Saver Mode, the inverter is initially in standby mode and sends a pulse to detect the presence of a load every 3 seconds. Each pulse lasts for 250ms. The inverter will remain in standby mode until a load has

been detected. Then it will wake up from standby mode and start to invert electricity from the battery bank to supply the load. As this function is under Battery Priority, the inverter will always prefer to invert electricity from battery first even there is a qualified AC input present. Only when the battery voltage is lower than the low voltage alarm point, will the inverter switch to AC input power to charge the battery and supply the load at the same time.

This Power Saver Mode can be changed to Unit Off Charging mode via SW3 by switching it to “0” position. (SW5 still in “1”)

In Unit Off Charging mode, the inverter will stay in standby mode without sensing loads. It won't output any power even if a load is turned on or a qualified AC input is present. The inverter will not perform any function and only stay idle in this mode, unless the battery voltage is low. Then it will start charging the battery. This feature is ideally suitable for applications where energy conservation is required. Charging will only be activated when required.

Frequency Switch(SW4):

The output frequency of the inverter can be set at either 50Hz or 60Hz by SW4.

AC/Battery Priority(SW5):

This inverter is designed with AC priority by default. This means, when AC input is present, the battery will be charged first, and the inverter will transfer the input AC to power the load. Only when the AC input is stable for a continuous period of 15 days will the inverter start a battery inverting cycle to protect the battery. After 1 normal charging cycle ac through put will be restored.

The AC Priority and Battery Priority switch is SW5. When you choose battery priority, the inverter will invert from battery despite the AC input. Only when the battery voltage reaches the low voltage alarm point (10.5Vdc for 12Vdc, 21Vdc for 24Vdc, 42Vdc for 48Vdc) will the inverter transfer to AC Input, charge battery, and switch back to battery when the battery is fully charged. This function is mainly for wind/solar systems using utility power as back up.

Note: In battery priority mode, when qualified AC inputs for the first time and the battery voltage is below 12.5Vdc(12.5Vdc for 12Vdc, 25Vdc for 24Vdc, 51Vdc for 48Vdc), the inverter will go into battery priority mode only after a cycle of bulk charging and absorb charging is finished. The inverter will not go into float charging mode.

2.5.12 Other Features

Battery Temperature Sensing

Applying the proper charge voltage is critical for achieving optimum battery performance and longevity. The ideal charge voltage required by batteries changes with battery temperature.

The battery temperature sensor allows the charge controller to continuously adjust charge voltage based on actual battery temperature.

Temperature compensation of charge voltage assures that the battery receives the proper charge voltage as battery temperature varies.

The entire line of Global LF are equipped with Battery Temperature Sensing for increased charging precision.

It sends precise information to the charger, which automatically adjusts voltage to help ensure full battery charge depending on the ambient temperature of your battery installation.

When the battery voltage is over 40°C(104°F), it will reduce the charging voltage by 0.1Vdc with every degree of temperature rise.

AIMS recommends that you install Battery Temperature Sensors on all banks to protect your batteries and to

provide optimal charging of each bank.

The battery temperature sensor mounts on the side of a battery.

The spec is listed below

Inverter Condition	Temp on BST	Operation
Charger Mode	$BTS \geq 50^{\circ}C(122^{\circ}F)$	Automatically turns off charger
	$BTS \leq 40^{\circ}C(104^{\circ}F)$	Automatically turns on charger
Inverter Mode	$40^{\circ}C(104^{\circ}F) \leq BTS \leq 50^{\circ}C(122^{\circ}F)$	Increases the low voltage shut down point by 0.5Vdc
	$BTS \geq 50^{\circ}C(122^{\circ}F)$	Over Temp Fault

Battery voltage recovery start

After low battery voltage shut off (10V for 12V model or 20V for 24V model or 40V for 48V model), the inverter is able to restore operation after the battery voltage recovers to 13V/26V/52V (with power switch still in the “On” position). This function helps to save the users extra labor to reactivate the inverter when the low battery voltage returns to an acceptable range in renewable energy systems. The built-in battery charger will automatically reactivate as soon as city/generator ac has been stable for 15 seconds.



WARNING

Never leave the loads unattended, some loads (like a Heater) may cause accidents in such cases.

It is better to shut everything off after low voltage trip than to leave your load on, due to the risk of fire.

Auto Gen Start

The inverter can be customized to start up a generator when the battery voltage goes low.

When the inverter goes to low battery alarm, it can send a signal to start a generator, and turn the generator off after battery charging is finished.

The auto gen start feature will only work with generators designed to work with this feature. There is an open/close relay that will short circuit the positive and negative cable from a generator. The input DC voltage can vary, but the Max current the relay can carry is 16Amp.

Conformal Coating

AIMS Power entire line of Global LF inverters have been processed with a conformal coating on the PCB, making it water, rust, and dust resistant as well as corrosion resistant.

While these units are designed to withstand corrosion from the salty air, they are not splash proof.

3. Installation

* All wiring must follow the National Electric Code, Install shall be in accordance with the Canadian Electrical Code Part 1

3.1 Location

Follow all the local regulations to install the inverter.

Please install the equipment in a location that is dry, clean, cool with good ventilation.

Working temperature: -10°C-50°C(-14°Fto 122°F) Maximum working temperature40°C

Storage temperature: -40-70°C(-40°Fto 158°F)

Relative Humidity: 0% to 95%, non-condensing

Cooling: Forced air



WARNING

The unit is to be installed so that it is not expected to be contacted by persons.

3.2 DC Wiring

AIMS recommends keeping the battery bank as close as possible to the inverter. The following table is a suggested wiring option for applications using <10 feet of DC cable.

Please find the following minimum wire size. For applications using DC cable >10 feet, use a larger cable size.

Inverter Power	DC Input voltage	Wire Gage
10KW	48Vdc	1/0 AWG

Performance of any product can be improved by thicker cable and shorter runs, so if in doubt, round up and keep the length as short as possible.

For more wiring configurations for your specific system, please contact AIMS Power for more information.

***Installer to use protection not less than the short circuit current**



WARNING

The torque rating range for DC terminal is 19.8NM-24.6NM, and the suggested torque rating is 22.5NM. Over torquing may cause the bolt to break.

Additional flow protection must be added on the external battery box

In the event of reverse polarity, the unit could be totally destroyed and warranty voided!

When replacing batteries, use the same number and type of batteries.

Proper disposal of batteries is required, refer to your local codes for disposal requirements.

3.3 AC Wiring

We recommend using 10 to 5 AWG wire to connect to the ac terminal block.

When in AC mode the AC input power will supply both the loads and AC charger, a thicker wire gauge for AC Input is required. Consult a qualified electrician about the specific wire gauge required in terms of wire material and inverter power.

There are 3 different ways of connecting to the terminal block depending on the model. All the wirings are CE compliant, call our tech support if you are not sure about how to wire any part of your inverter.

<p style="text-align: center;">Wiring Option 1</p> <p>230V single phase Input: Hot line 1+ Hot line 2 +Ground 230Vac Output: Hot line 1+ Hot line 2+ Ground 230Vac Pump Output: Hot line 1+ Hot line 2+ Ground 230Vac(Only for water pumps)</p>	
<p style="text-align: center;">Wiring Option 2</p> <p>230V split phase Input: Hot line 1+ Hot line 2+Ground 230Vac Output: Hot line +Neutral 120Vac Pump Output: Hot line 1+ Hot line 2+ Ground 230Vac(Only for water pumps)</p> <p>Remark: In such case, each output hotline can only carry a max of half the rated capacity.</p> <p>WARNING: If only 120V load, please take priority to use Hot 1 line +Neutral, When the load power is more than 50% of inverter rated power then use Hot 2 line +Neutral</p>	



Caution:

Wiring Option 2 and 3 are only allowed for split phase models (last letter of part # “S”). Wire all the other models according to Wiring Option 1.



WARNING

For split phase models, AC input neutral is not required in wiring. Never Connect Input Neutral to Output Neutral. Damage will result which is not covered under warranty. Always switch on the inverter before plugging in any appliance.



WARNING

The output voltage of this unit must never be connected in its input AC terminal, overload or damage may result.

The torque rating range for AC terminal is 12.5NM-16.5NM, and the suggested torque rating is 15.2NM. Over torqueing may cause the bolt to break. Use NO. 8AWG ,60°C copper wires.

3.4 Grounding

Connect 8 AWG or greater copper wire between the grounding terminal on the inverter and the earth grounding system or the vehicle chassis.

3.5 Install Flange

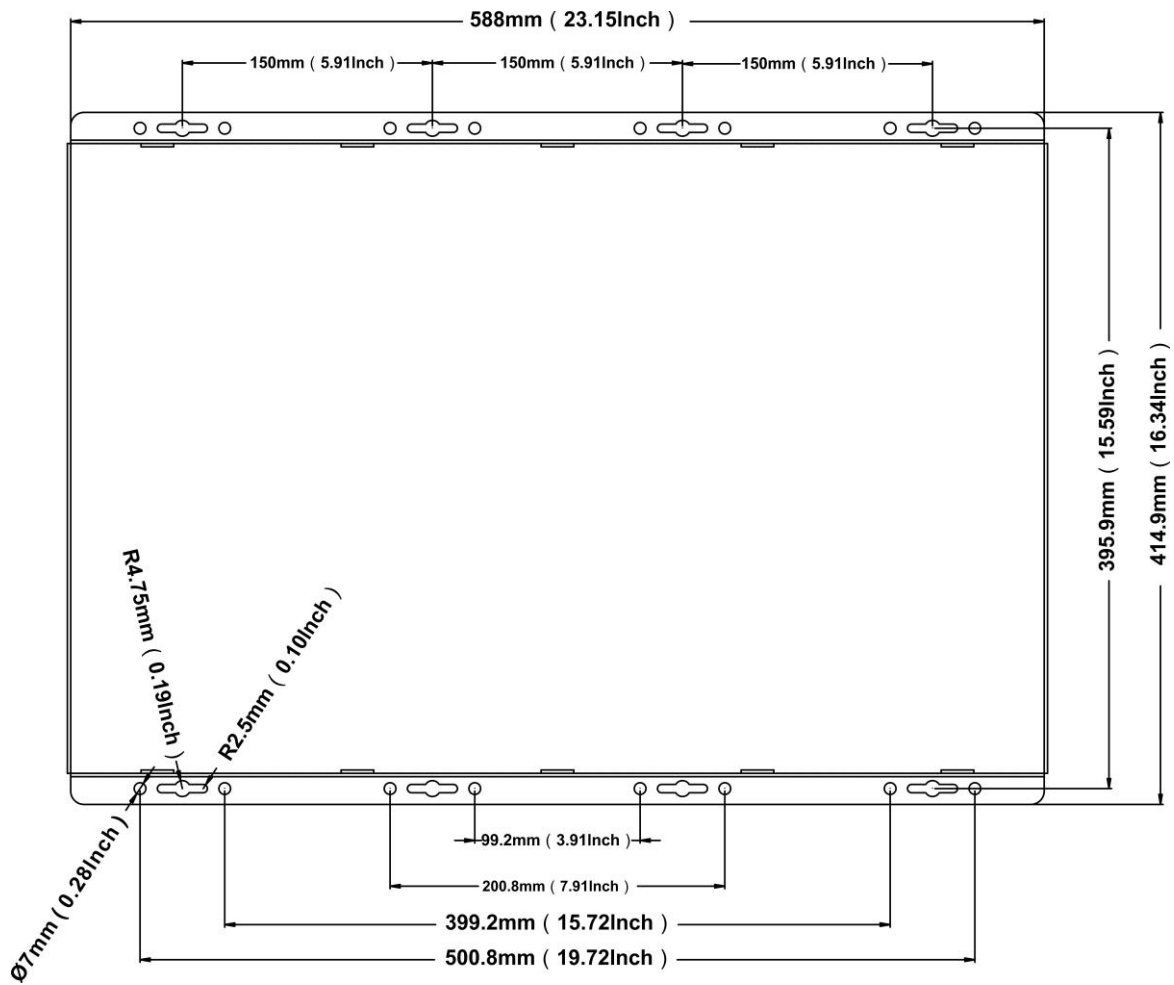

8KW and 12KW Models

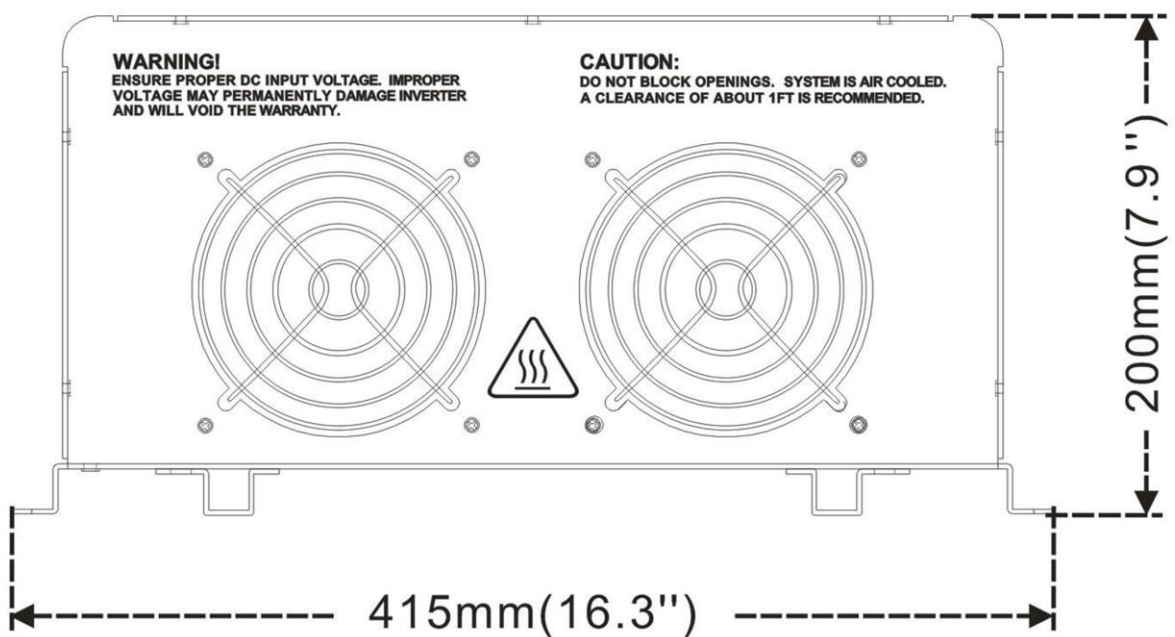

Side View

4. Troubleshooting Guide

Troubleshooting contains information about how to troubleshoot possible error conditions while using the Global LF Inverter & Charger.

The following chart is designed to help you quickly pinpoint the most common inverter failures.

Indicator and Buzzer

Status	Item	Indicator on top cover							LED on Remote Switch			
		SHORE POWER ON	INVERTER ON	FAST CHG	FLOAT CHG	OVER TEMP TRIP	OVER LOAD TRIP	POWER SAVER ON	BATT CHG	INVERTER	Alarm	Buzzer
Line Mode	CC	√	×	√	×	×	×	×	√	×	×	×
	CV	√	×	√, blink	×	×	×	×	√	×	×	×
	Float	√	×	×	√	×	×	×	√	×	×	×
	Standby	√	×	×	×	×	×	×	×	×	×	×
Inverter Mode	Inverter On	×	√	×	×	×	×	×	×	√	×	×
	Power Saver	×	×	×	×	×	×	√	×	×	×	×
Inverter Mode	Battery Low	×	√	×	×	×	×	×	×	√	√	Beep 0.5s every 5s
	Battery High	×	√	×	×	×	×	×	×	√	√	Beep 0.5s every 1s
	Overload On Invert Mode	×	√	×	×	×	√	×	×	√	√	Refer to “Audible alarm”
	Over-Temp On Invert Mode	×	√	×	×	√	×	×	×	√	√	Beep 0.5s every 1s
	Over-Temp On Line Mode	√	×	√	×	√	×	×	√	×	√	Beep 0.5s every 1s
	Over Charge	√	×	√	×	×	×	×	√	×	√	Beep 0.5s every 1s
Fault Mode	Fan Lock	×	×	×	×	×	×	×	×	×	×	Beep continuous
	Battery High	×	√	×	×	×	×	×	×	√	×	Beep continuous
	Inverter Mode Overload	×	×	×	×	×	√	×	×	×	×	Beep continuous
	Output Short	×	×	×	×	×	√	×	×	×	√	Beep continuous
	Over-Temp	×	×	×	×	√	×	×	×	×	×	Beep continuous
	Over Charge	×	×	√	×	×	×	×	√	×	×	Beep continuous
	Back Feed Short	×	×	×	×	×	×	×	×	×	×	Beep continuous

Symptom	Possible Cause	Recommended Solution
Inverter will not turn on during initial power up.	Batteries are not connected, loose battery-side connections. Low battery voltage.	Check the batteries and cable connections. Check DC fuse and breaker. Charge the battery.
No AC output voltage and no indicator lights ON.	Inverter has been manually transitioned to OFF mode.	Press the switch to Power saver on or Power saver off position.
AC output voltage is low and the inverter turns loads OFF in a short time.	Low battery.	Check the condition of the batteries and recharge if possible.
Charger is inoperative and unit will not accept AC.	AC voltage has dropped out-of-tolerance	Check the AC voltage for proper voltage and frequency.
Charger is supplying a lower charge rate.	Charger controls are improperly set. Low AC input voltage. Loose battery or AC input connections.	Refer to the section on adjusting the "Charger Rate". Source qualified AC power. Check all DC /AC connections.
Charger turns OFF while charging from a generator.	High AC input voltages from the generator.	Load the generator down with a heavy load. Turn the generator output voltage down.
Sensitive loads turn off temporarily when transferring between grid and inverting.	Inverter's Low voltage trip voltage may be too low to sustain certain loads.	Choose narrow AC voltage in the DIP switch, or Install a UPS if possible.
Noise from Transformer/case*	Applying specific loads such as hair drier	Remove the loads

***The reason for the noise from transformer and/or case**

When in inverter mode there may be instances of the transformer and/or case vibrates and makes noise. If the noise comes from transformer, it is a half wave load. A half wave load uses only half a cycle of the power. This tends to cause an imbalance of the magnetic field of the transformer, reducing its rated working freq from 20KHz to, say, maybe 15KHz (it varies according to different loads). If this happens, the frequency of noise falls exactly into the range (200Hz-20KHz) that human ears can hear.

The most common occurrence is with a hair drier. If the noise comes from the case, the inverter is loaded with an inductive load. The magnetic field generated by the transformer keeps attracting or releasing the steel case at a specific frequency and this may also cause noise.

Reducing the load power or using an inverter with bigger capacity will normally solve this problem. The noise will not do any harm to the inverter or the loads.

5. Warranty

This product is designed using the most modern digital technology and under very strict quality control and testing guidelines. If, however, you feel this product is not performing as it should, please contact us: techsupport@aimscorp.net or (775)359-6703.

We will do our best to resolve your concerns. If the product needs repair or replacement, make sure to keep your receipt/invoice, as that will need to be sent back along with the package and RMA# prepaid to AIMS. You have a full 1 year warranty from date of purchase.

This warranty is valid worldwide with the exception that freight and duty charges incurred outside the contiguous 48 United States will be prepaid by customer.

Except as noted above, AIMS makes no warranty of any kind, express or implied, including without limitation the implied warranties of merchantability and fitness for a particular purpose. In no event shall AIMS be liable for indirect, special or consequential damages. This warranty only applies to AIMS Power branded products. All other name brand products are warranted by and according to their respective manufacturer. Please do not attempt to return non-AIMS Power branded products to AIMS Power.

The following situations will void warranty:

1. The box is distorted, damaged or changed, and interior parts damaged because of an exterior hit or drop not reported at time of delivery.
2. Connect the DC power incorrectly reversing the polarity.
3. Dismantled or repaired the unit by an unauthorized person.
4. The unit was damaged by incorrect installation or operating method.

For additional products, please visit our web site: www.aimscorp.net

- Modified sine wave inverters
- Pure sine wave inverters
- Low Frequency Inverters
- Solar Charge Controllers
- Micro Grid Tied Inverters
- Inverter Chargers and Automatic transfer switches
- Converters DC-DC
- Custom cut cables
- Batteries
- Solar Panels & Racks

To find out where to buy any of our products, you may also e-mail: sales@aimscorp.net or call (775)359-6703.

Appendix 1

Global LF Series Inverter & Charger Spec Sheet			
Electrical Specifications			
Inverter Output	Model	PICOGLF10KW48V240VS	
	Continuous Output Power	10,000W	
	Surge Rating(20s)	30,000W	
	Capable of Starting Electric Motor	10HP	
	Output Waveform	Pure Sine wave/Same as input (Bypass mode)	
	Nominal Efficiency	>88% (Peak)	
	Line Mode Efficiency	>95%	
	Power Factor	0.9-1.0	
	Nominal Output Voltage RMS	100-110-120Vac / 220-230-240Vac	
	Output Voltage Regulation	± 10% RMS	
	Output Frequency	50/60Hz ± 0.3Hz	
	Short Circuit Protection	Yes, Current Limit Function (Fault after 1sec)	
	Typical transfer Time	10ms (Max)	
	THD	Max 7% under full linear load	
DC Input	Nominal Input Voltage	12.0Vdc (*2 for 24Vdc, *4 for 48Vdc)	
	Minimum Start Voltage	10.0Vdc	
	Low Battery Alarm	10.5Vdc / 11.0Vdc	
	Low Battery Trip	10.0Vdc / 10.5Vdc	
	High Voltage Alarm & Fault	16.0Vdc	
	High DC Input Recovery	15.5Vdc	
	Low Battery Voltage Recover	13.0Vdc	
	Idle Consumption-Search Mode	< 25 W when Power Saver On	
Charge	Input Voltage Range	Narrow: 100~135VAC / 194~243VAC; Wide: 90~135VAC / 164~243VAC;	
	Input Frequency Range	Narrow: 47-55 ± 0.3Hz for 50Hz, 57-65 ± 0.3Hz for 60Hz Wide:43 ± 0.3Hz plus for 50Hz / 60Hz	
	Output Voltage	Depends on battery type	
	Charger Breaker Rating(230Vac)	40A	40A
	Charger Breaker Rating(120Vac)	not available	not available
	Max Charge Rate	15A to 120A +/-5A, depending on models, refer to 2.5.2 AC Charger	
	Over Charge Protection Shutdown	15.7V for 12Vdc (*2 for 24Vdc, *4 for 48Vdc)	
	Battery type	Fast Vdc	Float Vdc
	Gel U.S.A	14.0	13.7
	A.G.M 1	14.1	13.4

	A.G.M 2	14.6	13.7
	Sealed Lead Acid / Lithium **	14.4	13.6
	Gel Euro	14.4	13.8
	Open Lead Acid	14.8	13.8
	Calcium	15.1	13.6
	De-sulphation	15.5 for 4hrs	
	Remote Control	Yes. Optional	
Bypass & Protection	Input Voltage Waveform	Sine wave (Grid or Generator)	
	Nominal Voltage	120Vac	230Vac
	Low Voltage Trip	80V/90V±4%	184V/154V±4%
	Low Voltage Re-engage	90V/100V±4%	194V/164V±4%
	High Voltage Trip	140V±4%	253V±4%
	High Voltage Re-engage	135V±4%	243V±4%
	Max Input AC Voltage	150VAC	270VAC
	Nominal Input Frequency	50Hz or 60Hz (Auto detect)	
	Low Frequency Trip	Narrow: 47±0.3Hz for 50Hz, 57±0.3Hz for 60Hz Wide:40±0.3Hz for 50Hz/60Hz	
	Low Frequency Re-engage	Narrow: 48±0.3Hz for 50Hz, 58±0.3Hz for 60Hz Wide:45±0.3Hz for 50Hz/60Hz	
	High Frequency Trip	Narrow: 55±0.3Hz for 50Hz, 65±0.3Hz for 60Hz Wide: 70Hz for 50Hz/60Hz	
	High Frequency Re-engage	Narrow: 54±0.3Hz for 50Hz, 64±0.3Hz for 60Hz Wide: 68Hz for 50Hz/60Hz	
	Output Short Circuit Protection	Circuit Breaker	
	Bypass breaker rating(230Vac)	63A	
Bypass breaker rating(120Vac)	not available	not available	
Mechanical Specification	Mounting	Wall Mount- Predrilled Holes Any Orientation Except Upside Down	
	Inverter Dimensions(L*W*H)	588*415*200mm / 23.3*16.3*7.9"	
	Inverter Weight	66KG / 145 lb	
	Shipping Dimensions(L*W*H)	725*512*270mm / 30*20*11"	
	Shipping Weight	79KG / 174 lb	
	Display	Status LEDs+LCD	
	Standard Warranty	1 Year	

※Specifications in this manual are subject to change without prior notice.

****CHECK LITHIUM BATTERY CHARGING SPECIFICATIONS**

