

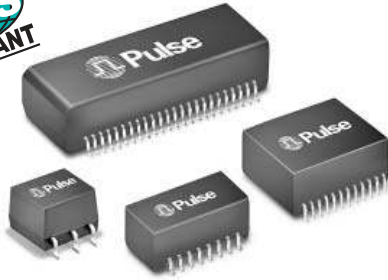



POWER OVER ETHERNET (PoE) MAGNETICS

10/100BASE-TX VoIP Magnetics Modules



-  RoHS peak reflow temperature rating 245°C
-  IEEE 802.3af/ANSI X3.263 compliant performance
-  Designed for IP phone or switch applications

Electrical Specifications @ 25°C — Operating Temperature 0°C to 70°C

Part Number	Ports	Insertion Loss (dB MAX)	Return Loss (dB MIN @ 100 Ω)					Differential to Common Mode Rejection (dB MIN)			Cross Talk (dB MIN)			Hipot (Vrms MIN))	DC Resistance Balance ≤ (%)
			1-100 MHz	1-30 MHz	40 MHz	50 MHz	60-80 MHz	30 MHz	60 MHz	100 MHz	30 MHz	60 MHz	100 MHz		
H1187NL ^{2a}	1	-1.2	-16	-14	-13	-12	-43	-37	-33	-45	-40	-35	1500	—	
H1197NL ^{2a}	1	-1.2	-16	-14	-13	-12	-43	-37	-33	-45	-40	-35	1500	—	
H2019NL ^{2a}	1	-1.2	-16	-14	-13	-12	-43	-37	-33	-45	-40	-35	1500	3.5	
H2005ANL ^{2c}	2	-1.2	-16	-14	-13	-12	-50	-43	-35	-43	-37	-33	1500	3.5	
H2006ANL ^{2c}	2	-1.2	-16	-14	-13	-12	-43	-37	-33	-43	-37	-31	1500	3.5	
H2008NL ^{2c}	2	-1.2	-16	-14	-13	-12	-40	-35	-30	-43	-37	-33	1500	3.5	
H2009NL ^{2a}	2	-1.1	-16	-14	-13	-12	-43	-37	-33	-43	-37	-33	1500	3.5	
H2014NL ^{2d}	4	-1.2	-16	-14	-13	-12	-43	-37	-33	-45	-40	-35	1500	3.5	
H2017NL ^{2c}	4	-1.2	-16	-14	-13	-12	-43	-37	-33	-45	-40	-35	1800	3.5	
HX2019NL ^{1,2a}	1	-1.4	-16	-14	-13	-12	-43	-37	-33	-45	-40	-35	1500	3.5	

1. **Extended** operating temperature (-40°C to +85°C)
2. **MSL** (Moisture Sensitivity Level): a = 1, b = 2, c = 3, d = 4, e = 5

NOTE: When ordering Tape & Reel packaging, add the suffix "T" to the end of the part number. For example: H2008NLT.

Mechanics

H1187NL

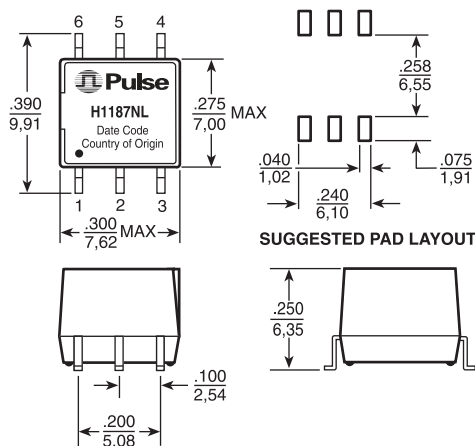

Weight 0.6 grams
Tape & Reel 500/reel
Tube 70/tube

Dimensions: $\frac{\text{Inches}}{\text{mm}}$ Unless otherwise specified, all tolerances are $\pm \frac{.010}{0.25}$

H1197NL

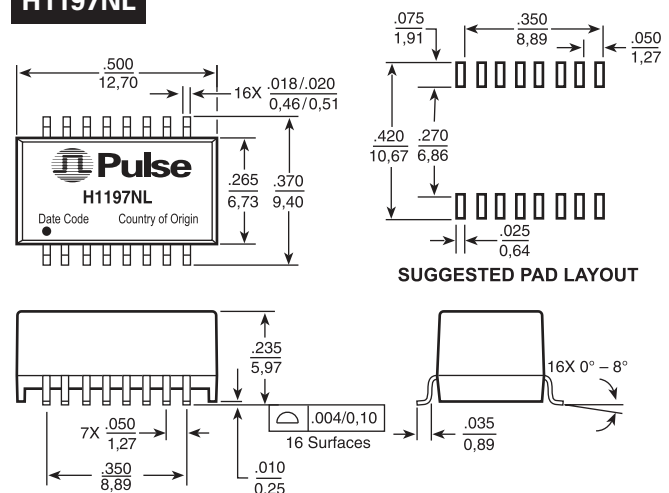

Weight 2.8 grams
Tape & Reel 600/reel
Tube 45/tube

POWER OVER ETHERNET (PoE) MAGNETICS

10/100BASE-TX VoIP Magnetics Modules



Mechanicals

H2019NL, HX2019NL

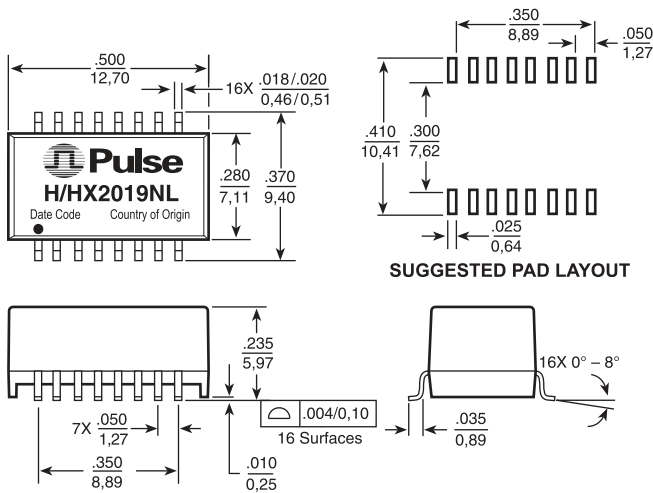

H2005ANL

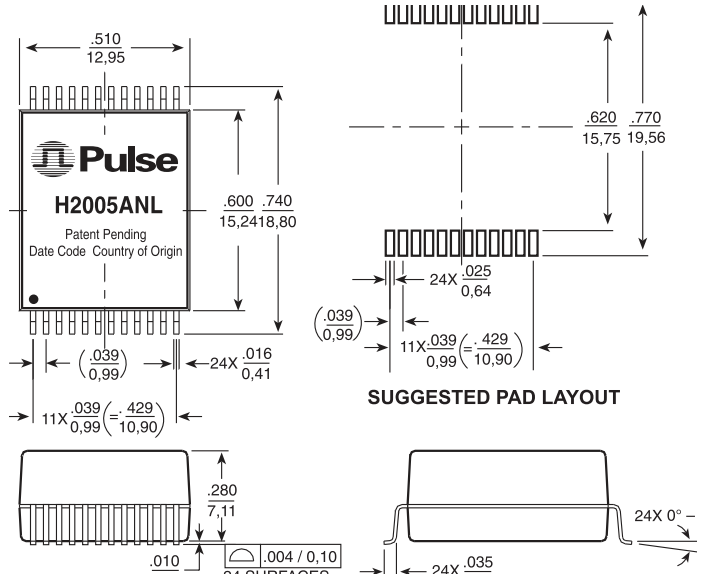

Weight 1.0 grams
Tape & Reel 600/reel
Tube 45/tube

Dimensions: $\frac{\text{Inches}}{\text{mm}}$ Unless otherwise specified, all tolerances are $\pm \frac{.010}{0,25}$

Weight 2.7 grams
Tape & Reel 300/reel
Tube 25/tube

H2006ANL, H2008NL

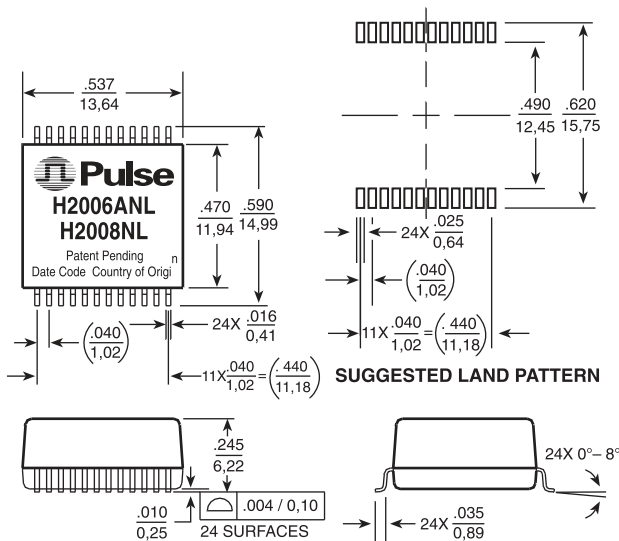

H2009NL

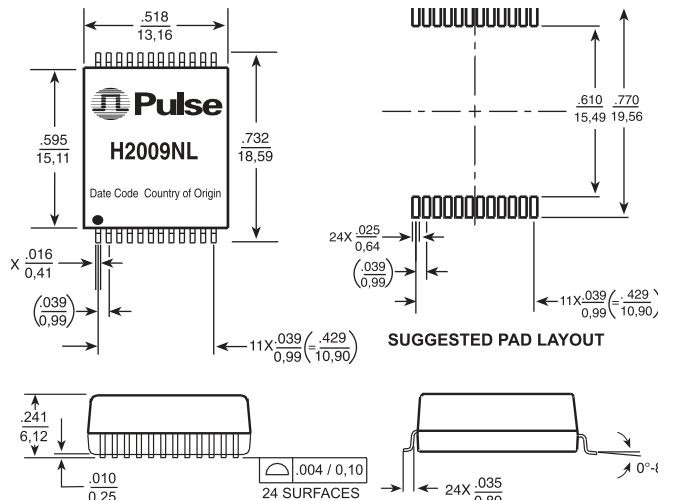

Weight 2.4 grams
Tape & Reel 350/reel
Tube 35/tube

Dimensions: $\frac{\text{Inches}}{\text{mm}}$ Unless otherwise specified, all tolerances are $\pm \frac{.010}{0,25}$

Weight 1.6 grams
Tape & Reel 300/reel
Tube 35/tube

POWER OVER ETHERNET (PoE) MAGNETICS

10/100BASE-TX VoIP Magnetics Modules



Mechanicals (continued)

H2014NL, H2017NL

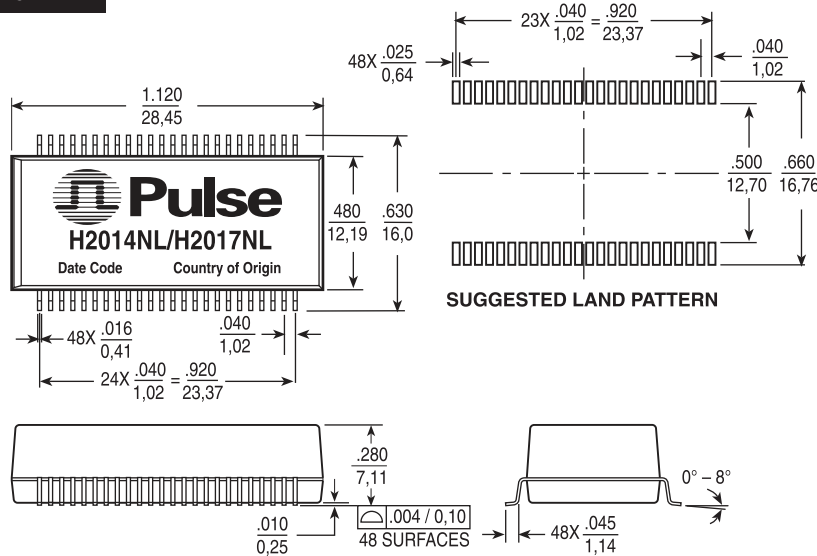

Dimensions: $\frac{\text{Inches}}{\text{mm}}$ Unless otherwise specified, all tolerances are $\pm \frac{.010}{0,25}$

Weight 5.0 grams
Tape & Reel 250 /reel
Tube 15/tube

Schematics

H2019NL, HX2019NL

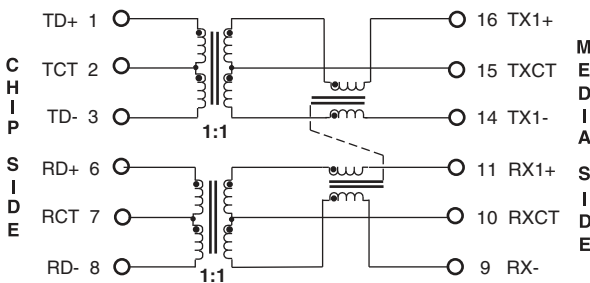

H1187NL

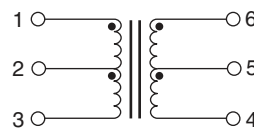

H1197NL

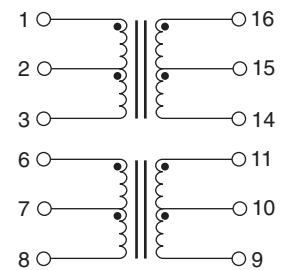

POWER OVER ETHERNET (PoE) MAGNETICS

10/100BASE-TX VoIP Magnetics Modules



Schematics (continued)

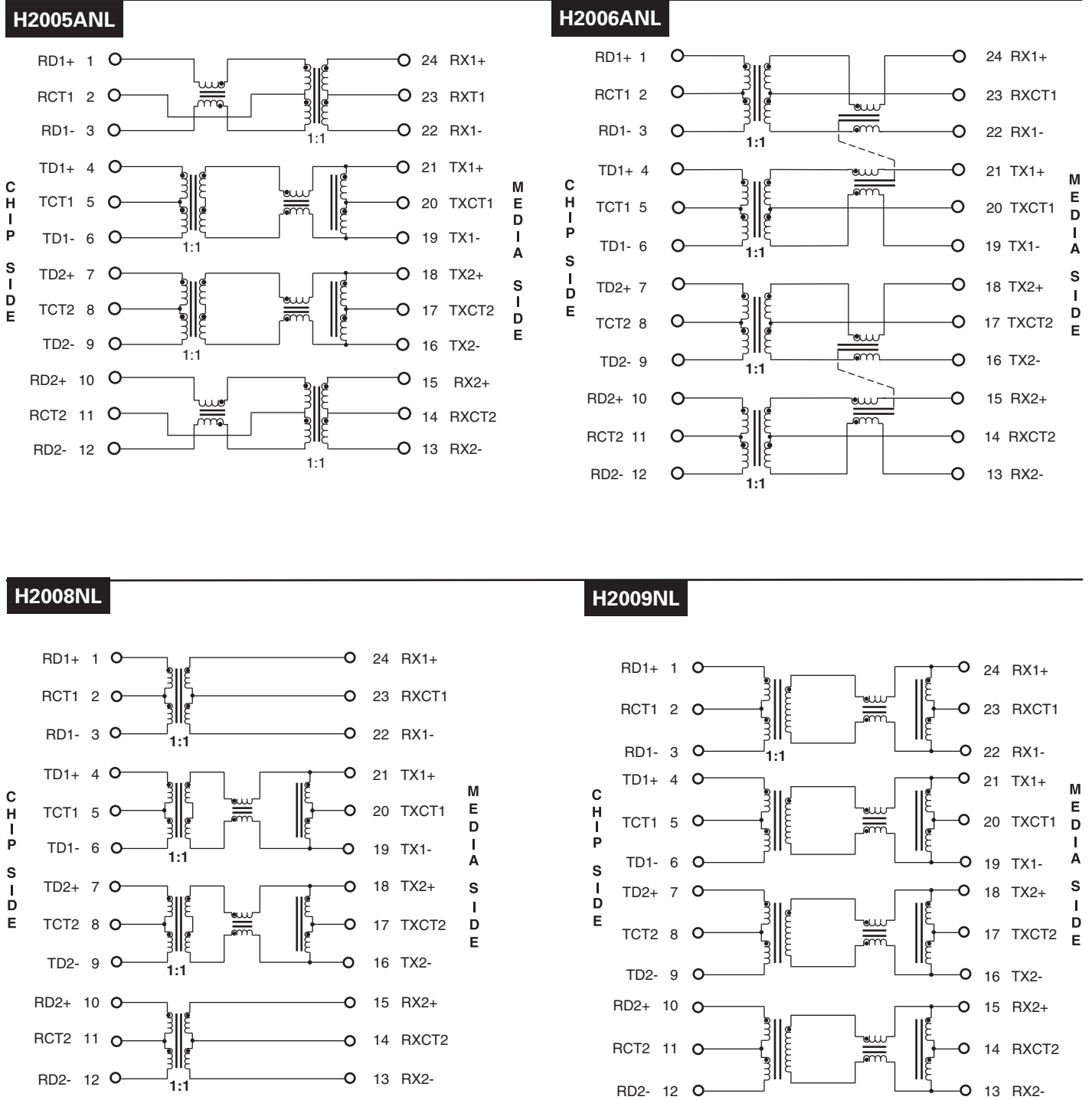

POWER OVER ETHERNET (PoE) MAGNETICS

10/100BASE-TX VoIP Magnetics Modules



Schematics (continued)

H2014NL

MEDIA SIDE

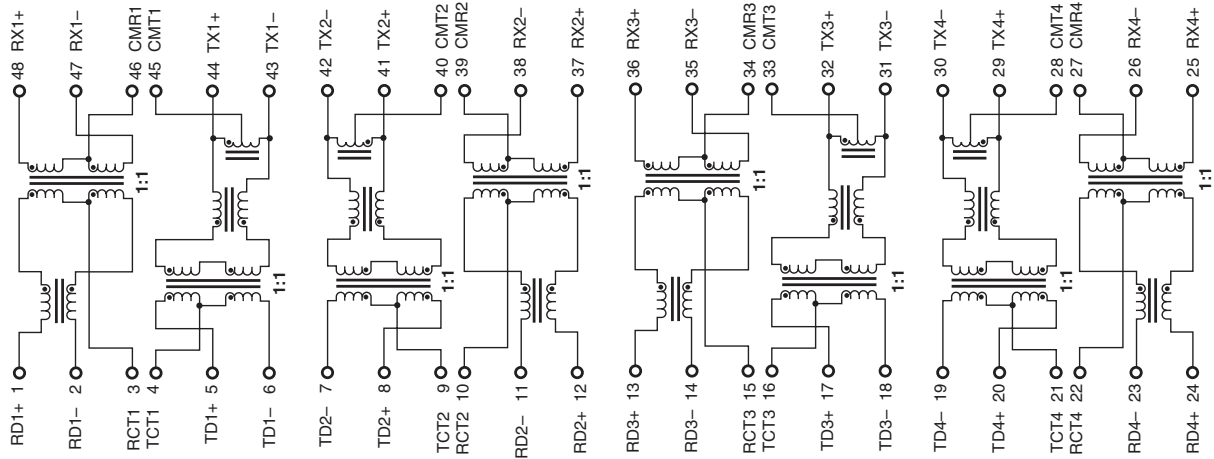

CHIP SIDE

H2017NL

MEDIA SIDE

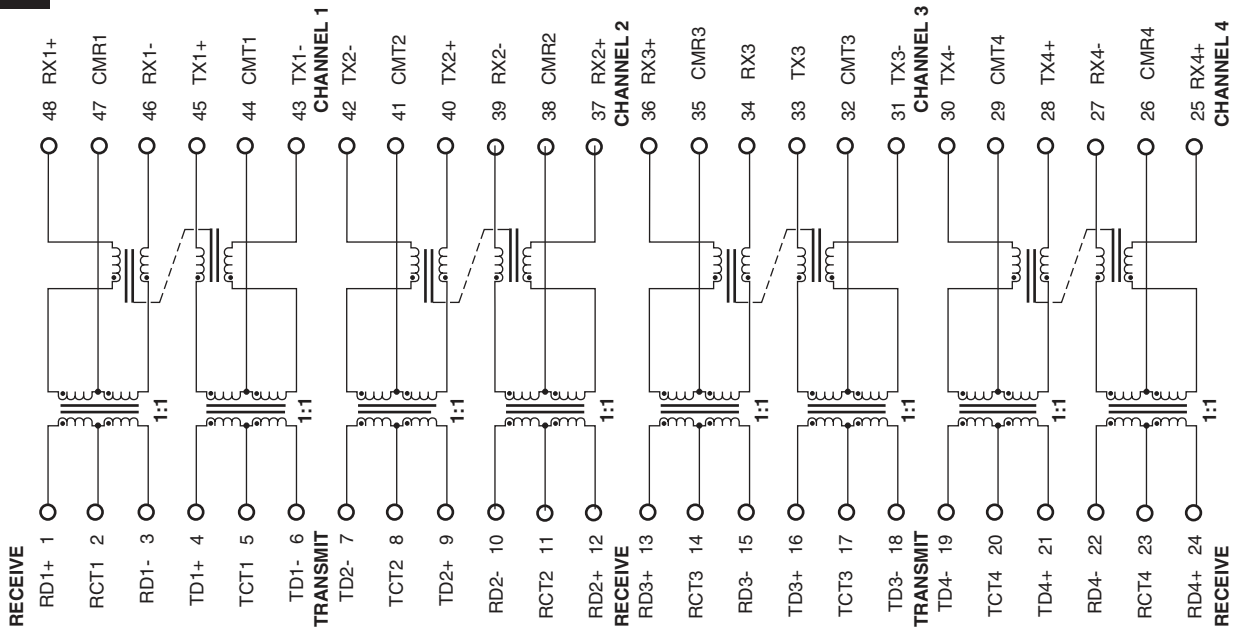

CHIP SIDE

For More Information:

Pulse Worldwide Headquarters

12220 World Trade Dr.
San Diego, CA 92128
U.S.A.

Pulse Europe

Einsteinstrasse 1
D-71083 Herrenberg
Germany

Pulse China Headquarters

B402, Shenzhen Academy of
Aerospace Technology Bldg.
10th Kejinan Rd.
High-Tech Zone
Nanshan District
Shenzhen, PR China 518057

Pulse North China

Room 1503
XinYin Building
No. 888 YiShan Rd.
Shanghai 200233
China

Pulse South Asia

135 Joo Seng Rd.
#03-02
PM Industrial Bldg.
Singapore 368363

Pulse North Asia

No. 26, Kao Ching Rd.
Yang Mei Chen
Taoyuan Hsien
Taiwan
R. O. C.

www.pulseeng.com

Tel: 858 674 8100
Fax: 858 674 8262

Tel: 49 7032 7806 0
Fax: 49 7032 7806 135

TEL: 86 755 33966678
FAX: 86 755 33966700

Tel: 86 21 54643211/2
Fax: 86 21 54643210

TEL: 65 6287 8998
FAX: 65 6280 0080

Tel: 886 3 4643715
Fax: 886 3 4641911

Performance warranty of products offered on this data sheet is limited to the parameters specified. Data is subject to change without notice. Other brand and product names mentioned herein may be trademarks or registered trademarks of their respective owners.

© Copyright, 2009, Pulse Engineering, Inc. All rights reserved.