

FP1010V

High frequency, high current power inductors



Product features

- Vertical design utilizes less board space
- Tight tolerance DCR for sensing circuits
- High current carrying capacity
- Low core loss
- Magnetically shielded
- Inductance range from 100 nH to 470 nH
- Current range from 30 A to 117 A
- 9.6 mm x 6.4 mm and 10 mm x 7.0 mm footprint surface mount package in a 10 mm height
- Ferrite core material
- Moisture sensitivity level (MSL): 1
- Weight: FP1010V1: 2.5 g typical, FP1010V4, V6: 2.98 g typical, FP1010V5: 3.0 g typical,

Applications

- Multi-phase and Vcore regulators
- Voltage Regulator Modules (VRMs) and high-power density VRMs
 - Server and desktop
 - Central processing unit (CPU)
 - Graphics processing unit (GPU)
 - Application specific integrated circuit (ASIC)
- Data networking and storage systems
- Graphics cards and battery power systems
- Point-of-Load modules (POL)
- DCR sensing circuits

Environmental data

- Storage temperature range (Component): -40 °C to +125 °C
- Operating temperature range: -40 °C to +125 °C (ambient plus self-temperature rise)
- Solder reflow temperature: J-STD-020 (latest revision) compliant



Product specifications

Part number ⁸	OCL ¹ (nH) ±10%	FLL ² (nH) minimum	I _{rms} ³ (A)	I _{sat} 1 ⁴ (A)	I _{sat} 2 ⁵ (A)	I _{sat} 3 ⁶ (A)	DCR (mΩ) @ +20 °C	K-factor ⁷
V1 Version								
FP1010V1-R100-R	100	72	68	97	88	85	0.145 ±5%	352
FP1010V1-R120-R	120	86	68	80	73	71	0.145 ±5%	352
FP1010V1-R150-R	150	108	68	65	59	57	0.145 ±5%	352
FP1010V1-R180-R	180	130	68	53	48	46	0.145 ±5%	352
V4 Version								
FP1010V4-R330-R	330	230	34	35	33	30	0.40 ±5%	216
V5 Version								
FP1010V5-R100-R	100	72	68	117	97	94	0.185 ±10%	308
FP1010V5-R120-R	120	86	68	98	82	79	0.185 ±10%	308
FP1010V5-R150-R	150	108	68	85	75	73	0.185 ±10%	308
FP1010V5-R330-R	330	237	68	35	29	27	0.185 ±10%	308
V6 Version								
FP1010V6-R330-R	330	231	54	40	32	30	0.40 ±5%	216
FP1010V6-R470-R	470	329	54	30	22	21	0.40 ±5%	216

- Open circuit inductance (OCL) Test parameters: 100 kHz, 0.1 Vrms, 0.0 Adc, +25 °C
- Full load inductance (FLL) Test parameters: 100 kHz, 0.1 Vrms, I_{sat}1, +25 °C
- I_{ms}: DC current for an approximate temperature rise of 40 °C without core loss. Derating is necessary for AC currents. PCB layout, trace thickness and width, air-flow, and proximity of other heat generating components will affect the temperature rise. It is recommended that the temperature of the part not exceed +125 °C under worst case operating conditions verified in the end application.
- I_{sat}1: Peak current for approximately 20% rolloff @ +25 °C
- I_{sat}2: Peak current for approximately 20% rolloff @ +75 °C (FP1010V1), @ +100 °C (FP1010V4, V5, V6)
- I_{sat}3: Peak current for approximately 20% rolloff @ +100 °C (FP1010V1), @ +125 °C (FP1010V4, V5, V6)

- K-factor: Used to determine B_{pp} for core loss (see graph).
B_{p-p} = K * L * ΔI * 10⁻³ B_{p-p} (Gauss), K: (K-factor from table),
L: (Inductance in nH), ΔI (Peak to peak ripple current in Amps).
- Part number definition: FP1010Vx-Rxxx-R
FP1010V= Product code and size
x= Version indicator
Rxxx= Inductance value in μH, R= decimal point
-R suffix = RoHS compliant

Dimensions (mm)

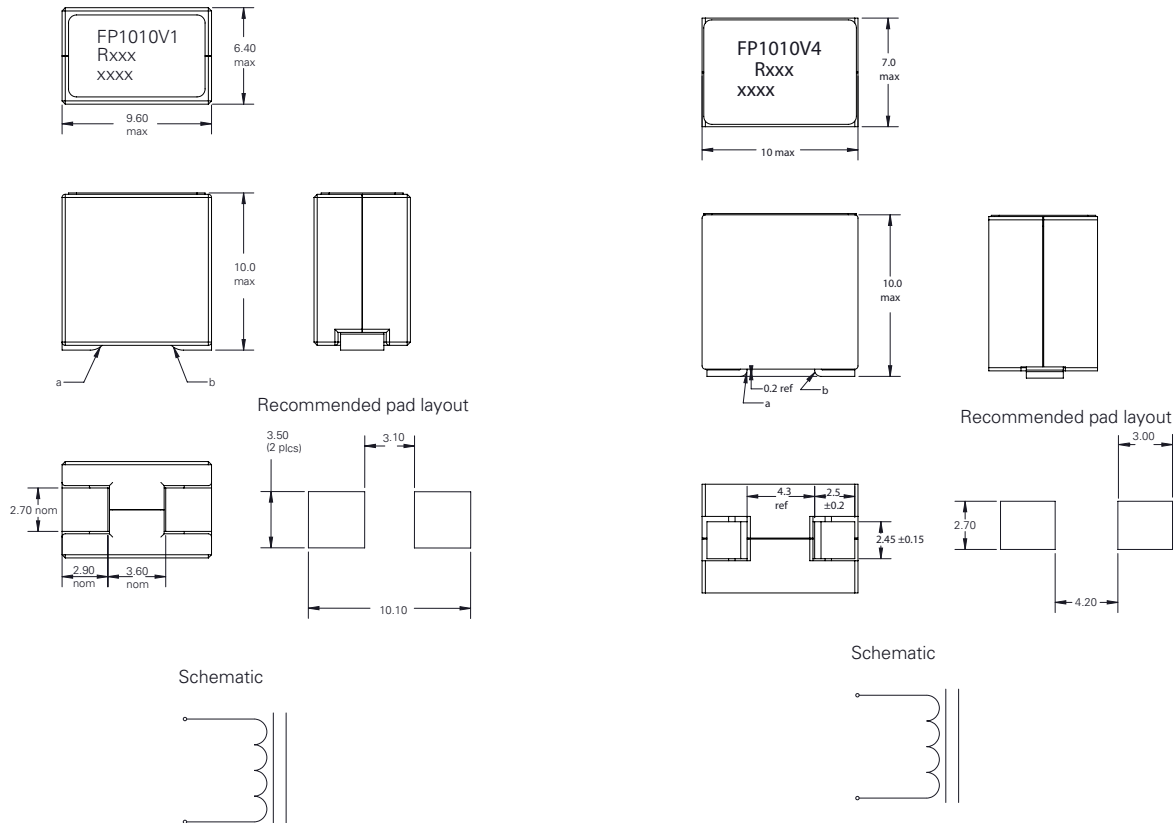

Dimensions (mm)

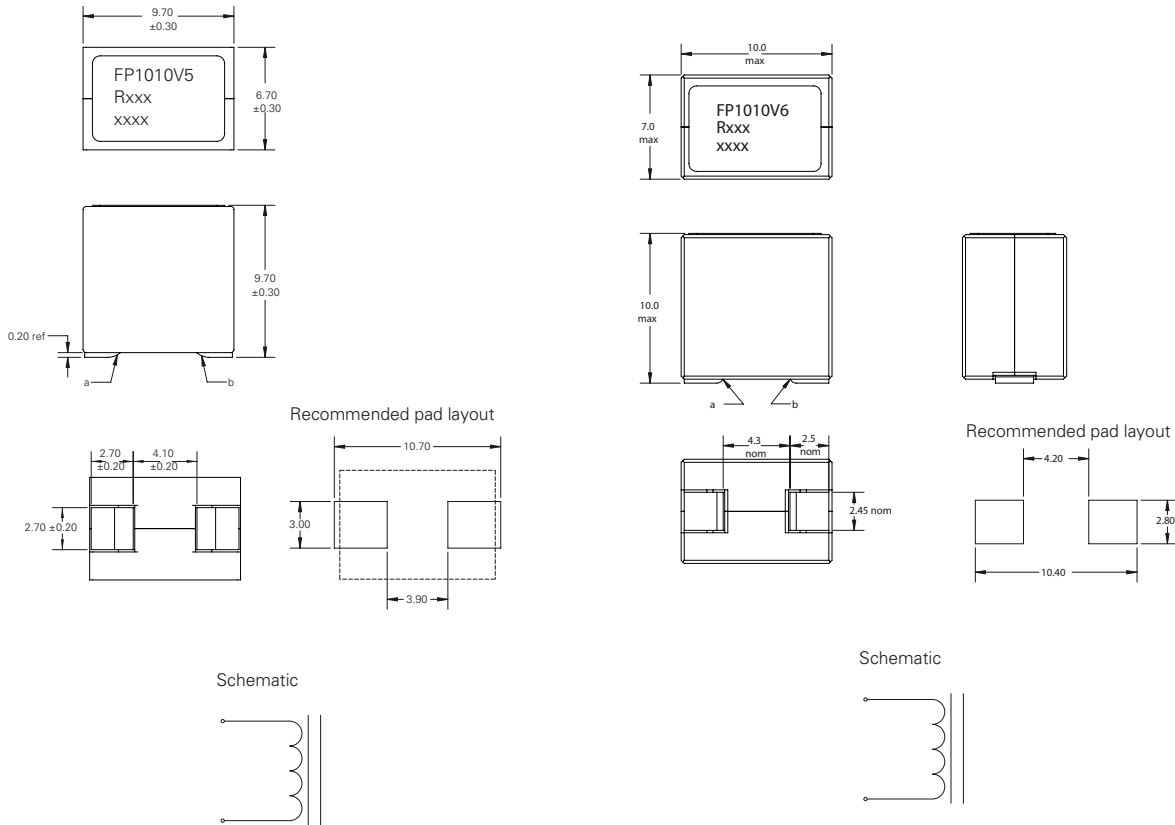

Part marking: FP1010Vx (x = Version indicator), Rxxx = Inductance value in uH, R= decimal point), xxxx=Lot code
 Tolerances are ± 0.15 unless stated otherwise
 Pad layout tolerances are ± 0.1 unless stated otherwise
 Soldering surfaces to be coplanar within 0.1 millimeters
 DCR measured from point "a" to point "b"
 Traces or vias underneath the inductor is not recommended

Packaging information (mm)

Supplied in tape and reel packaging , 300 parts per 13" diameter reel

FP1010V1

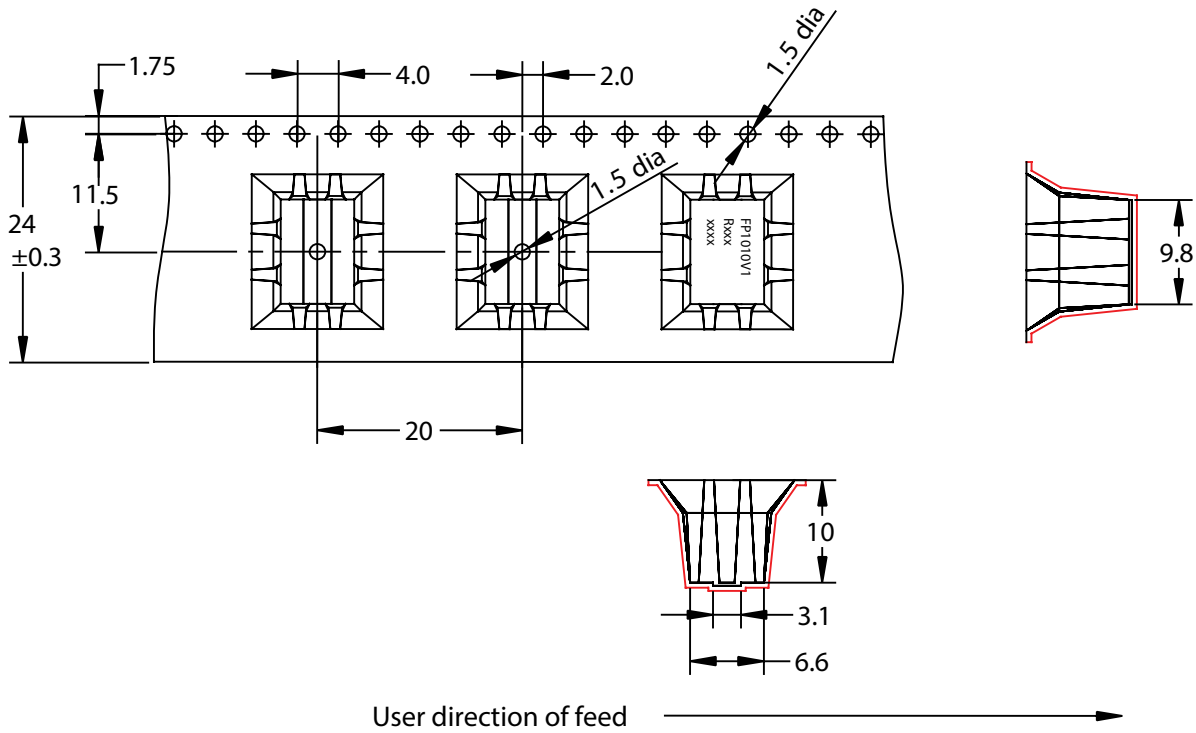

FP1010V4, V5, V6

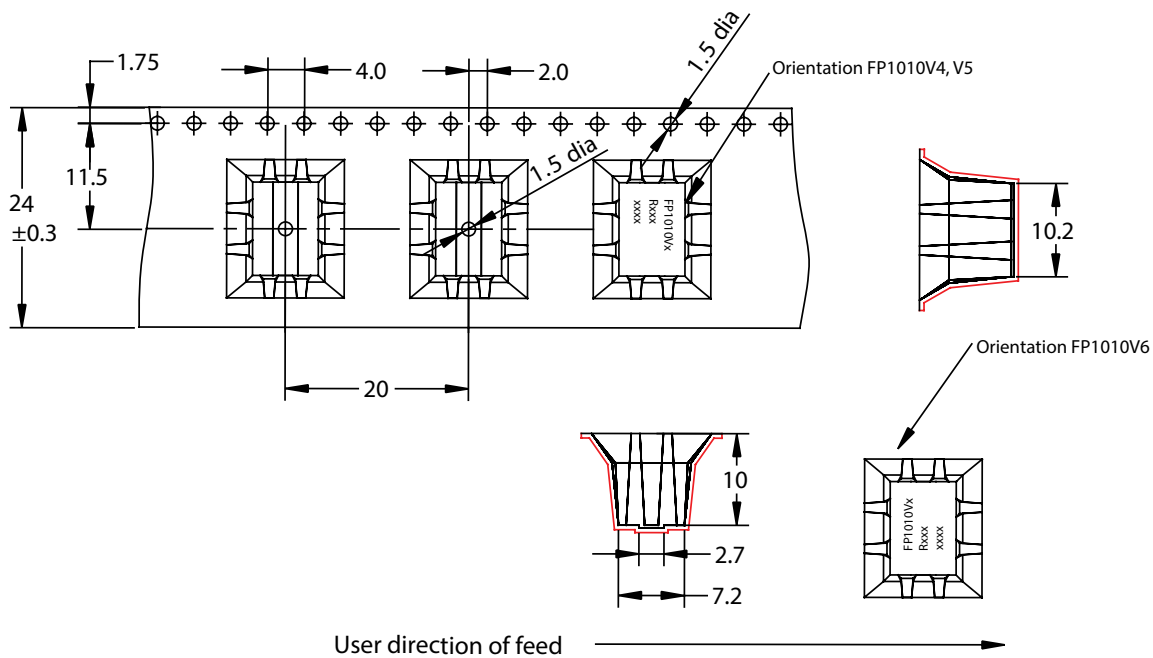

Temperature rise vs. total loss

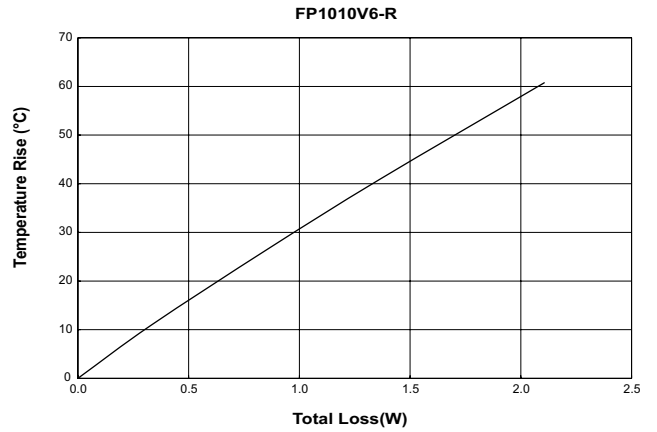
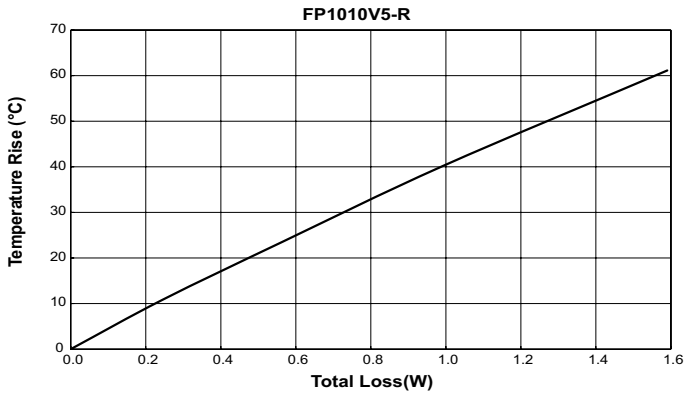
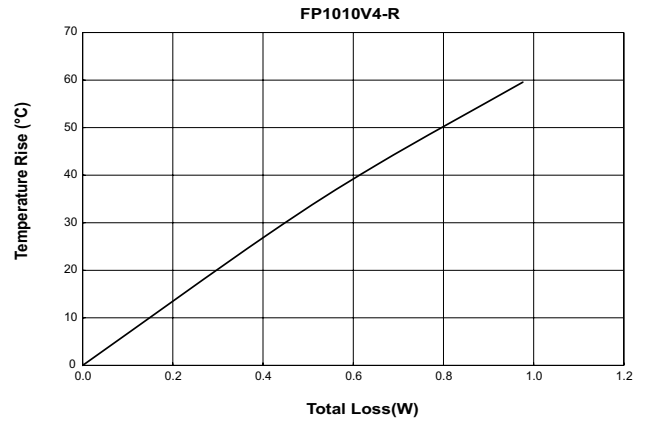
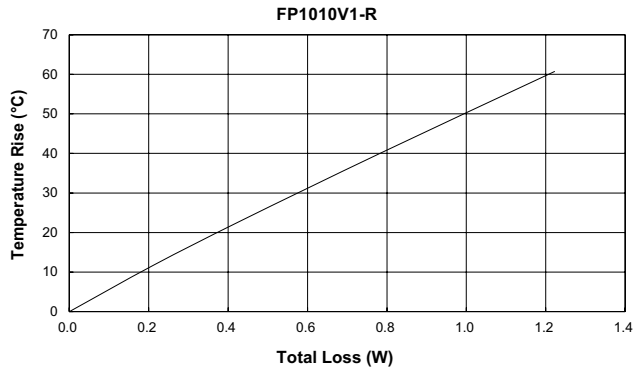

Core loss vs. B_p-p

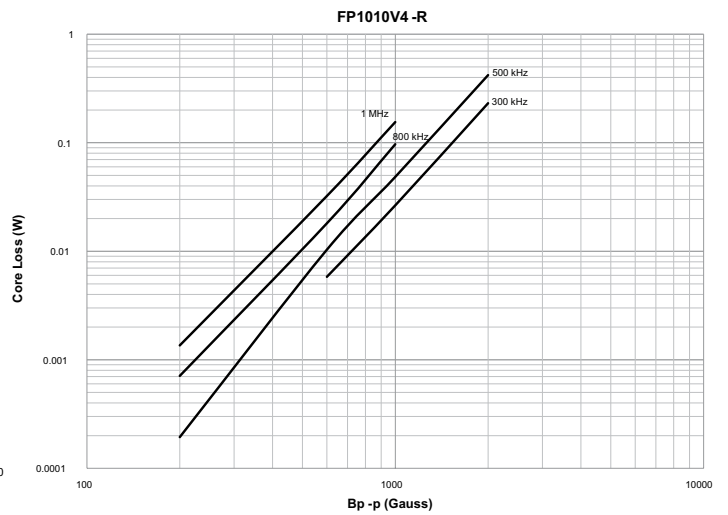
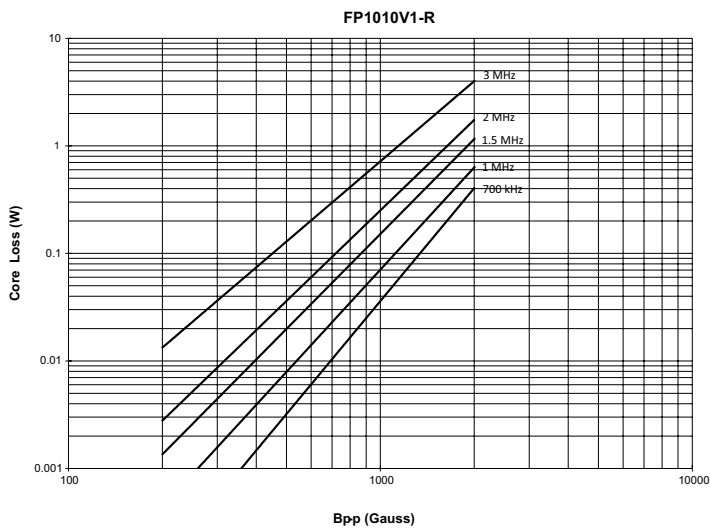

Core loss vs. B_{p-p}

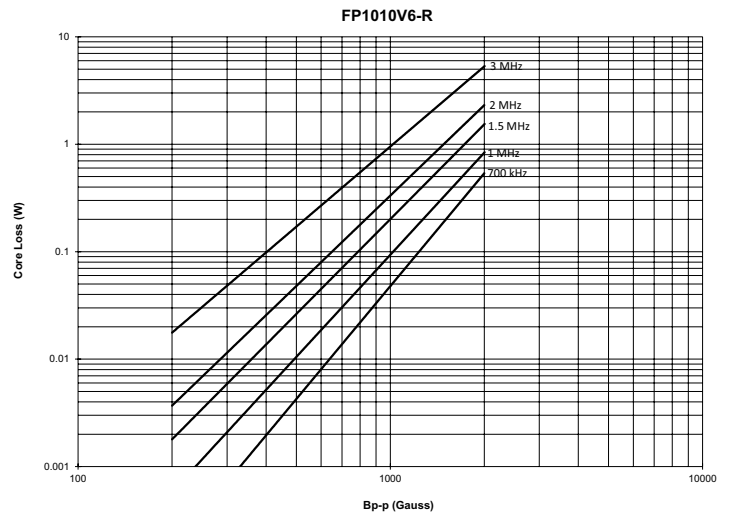
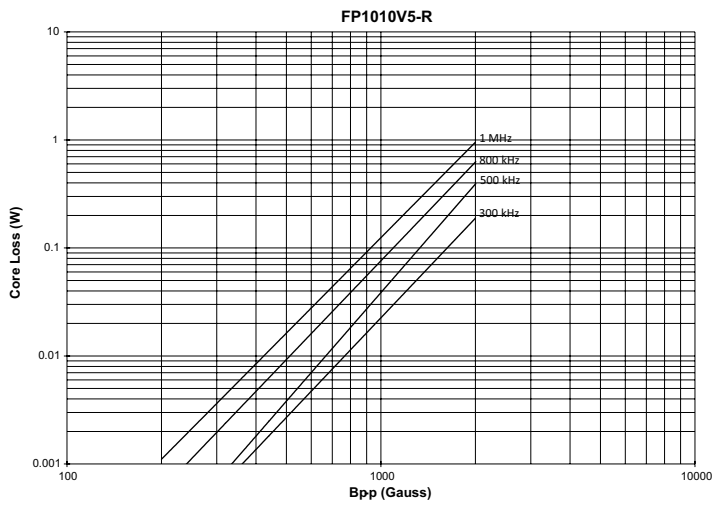

Inductance characteristics

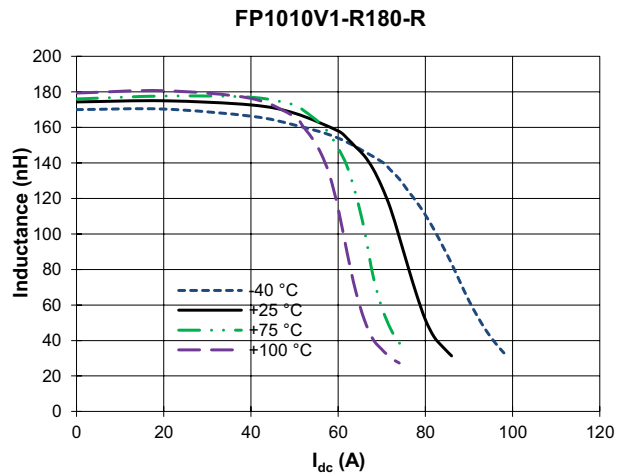
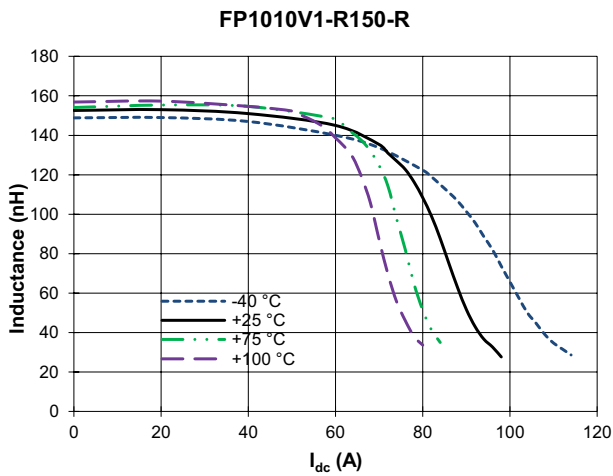
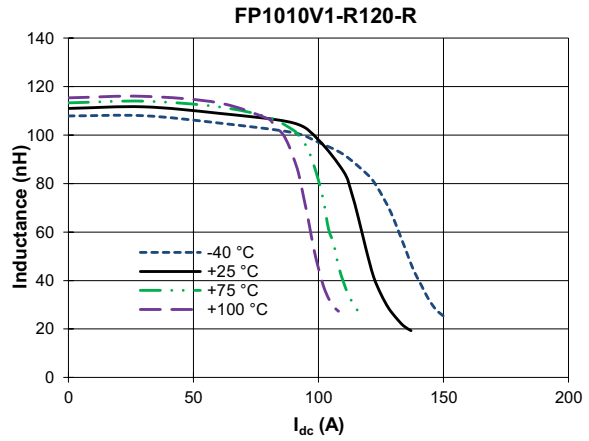
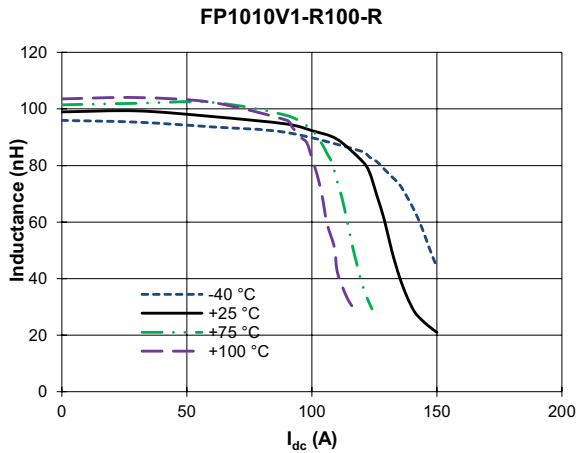

Inductance characteristics

FP1010V4-R330-R

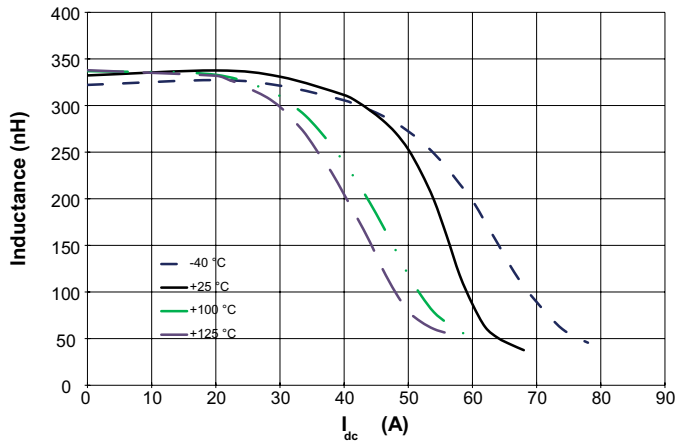

FP1010V5-R100-R

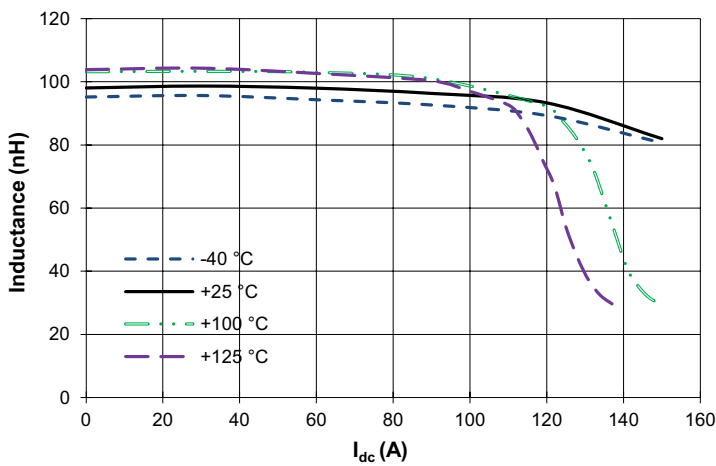

FP1010V5-R120-R

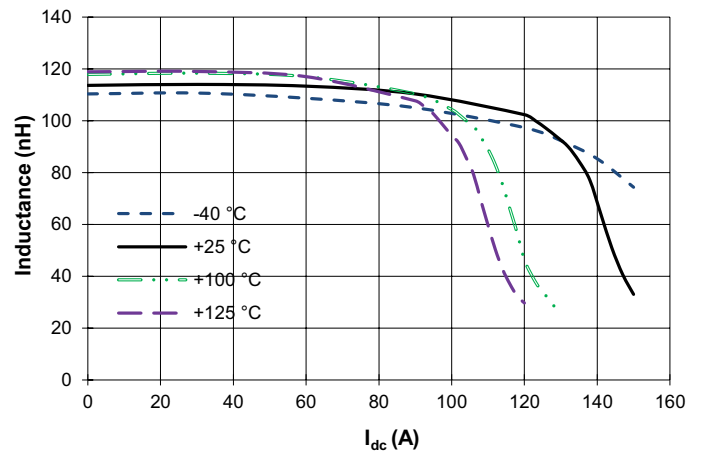

FP1010V5-R150-R

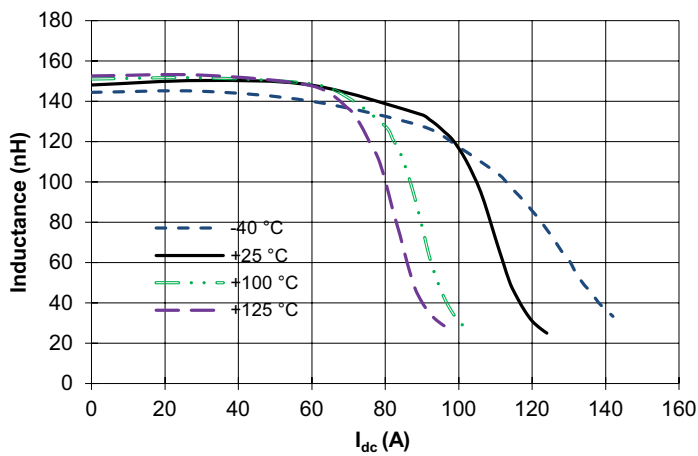

FP1010V5-R330-R

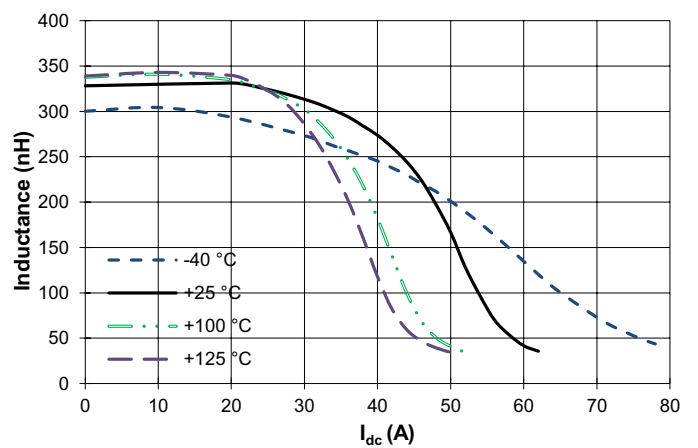

Inductance characteristics

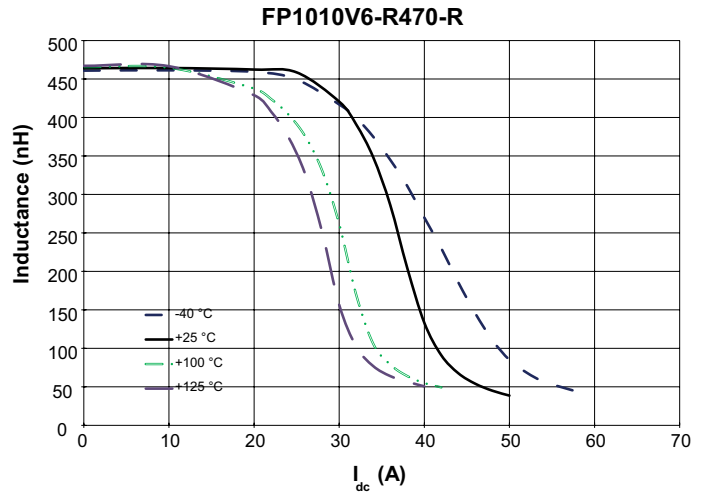
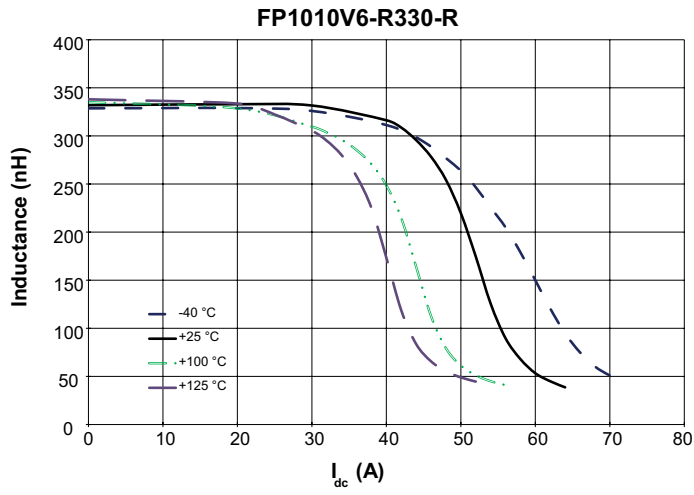

Solder reflow profile

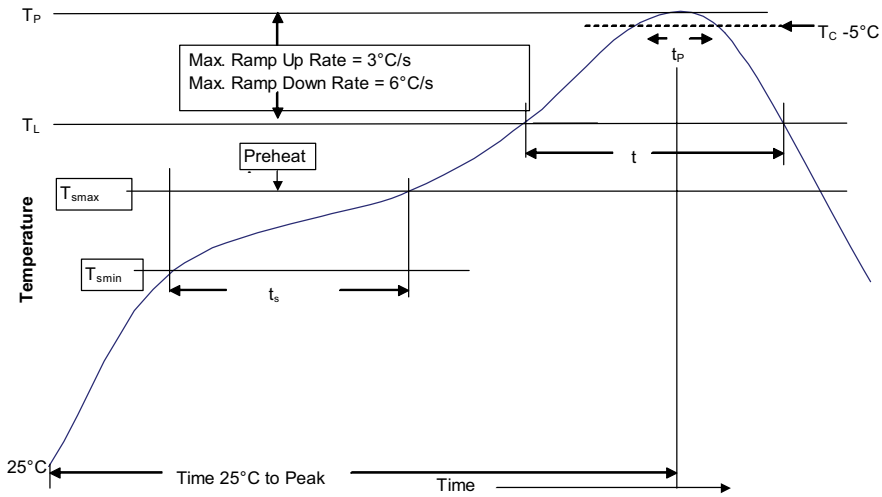

Table 1 - Standard SnPb solder (T_C)

Package thickness	Volume mm ³ <350	Volume mm ³ ≥350
<2.5 mm	235 °C	220 °C
≥2.5 mm	220 °C	220 °C

Table 2 - Lead (Pb) free solder (T_C)

Package thickness	Volume mm ³ <350	Volume mm ³ 350 - 2000	Volume mm ³ >2000
<1.6 mm	260 °C	260 °C	260 °C
1.6 – 2.5 mm	260 °C	250 °C	245 °C
>2.5 mm	250 °C	245 °C	245 °C

Reference J-STD-020

Profile feature	Standard SnPb solder	Lead (Pb) free solder
Preheat and soak		
• Temperature min. (T _{smin})	100 °C	150 °C
• Temperature max. (T _{smax})	150 °C	200 °C
• Time (T _{smin} to T _{smax}) (t _s)	60-120 seconds	60-120 seconds
Ramp up rate T _L to T _p	3 °C/ second max.	3 °C/ second max.
Liquidous temperature (T _L)	183 °C	217 °C
Time (t _L) maintained above T _L	60-150 seconds	60-150 seconds
Peak package body temperature (T _p)*	Table 1	Table 2
Time (t _p)* within 5 °C of the specified classification temperature (T _C)	20 seconds*	30 seconds*
Ramp-down rate (T _p to T _L)	6 °C/ second max.	6 °C/ second max.
Time 25 °C to peak temperature	6 minutes max.	8 minutes max.

* Tolerance for peak profile temperature (T_p) is defined as a supplier minimum and a user maximum.

Life Support Policy: Eaton does not authorize the use of any of its products for use in life support devices or systems without the express written approval of an officer of the Company. Life support systems are devices which support or sustain life, and whose failure to perform, when properly used in accordance with instructions for use provided in the labeling, can be reasonably expected to result in significant injury to the user.

Eaton reserves the right, without notice, to change design or construction of any products and to discontinue or limit distribution of any products. Eaton also reserves the right to change or update, without notice, any technical information contained in this bulletin.

Eaton
Electronics Division
1000 Eaton Boulevard
Cleveland, OH 44122
United States
Eaton.com/electronics

© 2020 Eaton
All Rights Reserved
Printed in USA
Publication No. 10779
June 2020

Eaton is a registered trademark.

All other trademarks are property of their respective owners.

Follow us on social media to get the latest product and support information.

