

FEATURES

- Member of the Texas Instruments Widebus™ Family
- EPIC™ (Enhanced-Performance Implanted CMOS) Submicron Process
- Output Port Has Equivalent 26-Ω Series Resistors, So No External Resistors Are Required
- Designed to Comply With JEDEC 168-Pin and 200-Pin SDRAM Buffered DIMM Specification
- ESD Protection Exceeds 2000 V Per MIL-STD-883, Method 3015; Exceeds 200 V Using Machine Model (C = 200 pF, R = 0)
- Latch-Up Performance Exceeds 250 mA Per JESD 17
- Bus Hold on Data Inputs Eliminates the Need for External Pullup/Pulldown Resistors
- Package Options Include Plastic Shrink Small-Outline (DL), Thin Shrink Small-Outline (DGG), and Thin Very Small-Outline (DGV) Packages

NOTE: For tape-and-reel order entry, the DGG package is abbreviated to GR, and the DGV package is abbreviated to VR.

DESCRIPTION

This 16-bit universal bus driver is designed for 1.65-V to 3.6-V V_{CC} operation.

Data flow from A to Y is controlled by the output-enable (\overline{OE}) input. The device operates in the transparent mode when the latch-enable (\overline{LE}) input is low. When \overline{LE} is high, the A data is latched if the clock (CLK) input is held at a high or low logic level. If \overline{LE} is high, the A data is stored in the latch/flip-flop on the low-to-high transition of CLK. When \overline{OE} is high, the outputs are in the high-impedance state.

The output port includes equivalent 26-Ω series resistors to reduce overshoot and undershoot.

To ensure the high-impedance state during power up or power down, \overline{OE} should be tied to V_{CC} through a pullup resistor; the minimum value of the resistor is determined by the current-sinking capability of the driver.

Active bus-hold circuitry is provided to hold unused or floating data inputs at a valid logic level.

The SN74ALVCH162334 is characterized for operation from -40°C to 85°C.

DGG, DGV, OR DL PACKAGE
(TOP VIEW)

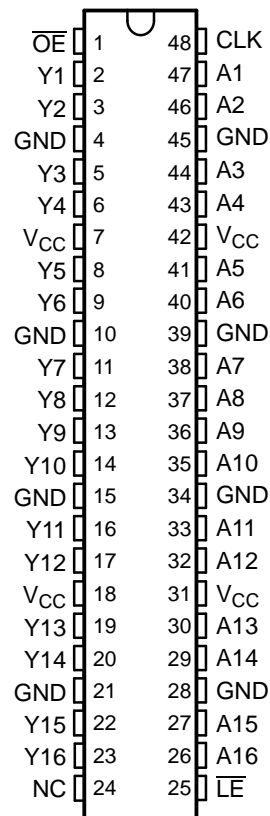

NC – No internal connection



Please be aware that an important notice concerning availability, standard warranty, and use in critical applications of Texas Instruments semiconductor products and disclaimers thereto appears at the end of this data sheet.

Widebus, EPIC are trademarks of Texas Instruments.

FUNCTION TABLE

INPUTS				OUTPUT Y
\overline{OE}	\overline{LE}	CLK	A	
H	X	X	X	Z
L	L	X	L	L
L	L	X	H	H
L	H	↑	L	L
L	H	↑	H	H
L	H	L or H	X	$Y_0^{(1)}$

(1) Output level before the indicated steady-state input conditions were established, provided that CLK is high before \overline{LE} goes high

LOGIC DIAGRAM (POSITIVE LOGIC)

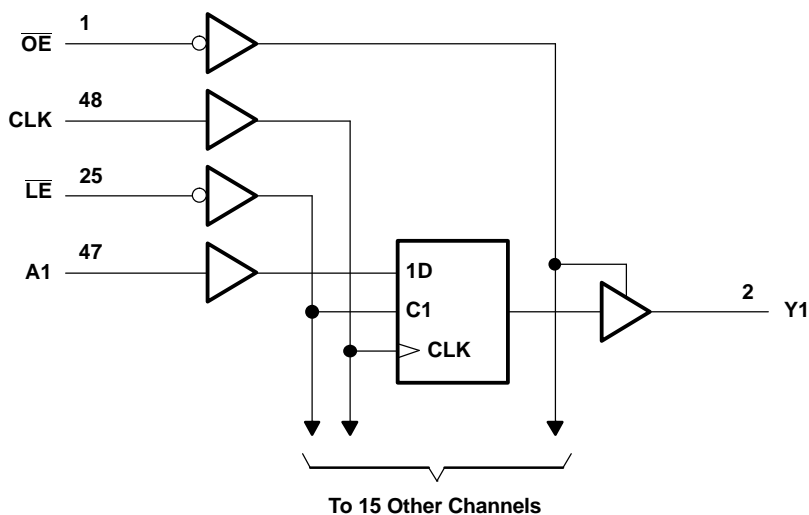

ABSOLUTE MAXIMUM RATINGS⁽¹⁾

over operating free-air temperature range (unless otherwise noted)

		MIN	MAX	UNIT
V_{CC}	Supply voltage range	-0.5	4.6	V
V_I	Input voltage range ⁽²⁾	-0.5	4.6	V
V_O	Output voltage range ⁽²⁾⁽³⁾	-0.5	$V_{CC} + 0.5$	V
I_{IK}	Input clamp current	$V_I < 0$		-50 mA
I_{OK}	Output clamp current	$V_O < 0$		-50 mA
I_O	Continuous output current			±50 mA
Continuous current through each V_{CC} or GND				±100 mA
θ_{JA}	Package thermal impedance ⁽⁴⁾	DGG package		89 °C/W
		DGV package		93
		DL package		94
T_{stg}	Storage temperature range	-65	150	°C

- (1) Stresses beyond those listed under "absolute maximum ratings" may cause permanent damage to the device. These are stress ratings only, and functional operation of the device at these or any other conditions beyond those indicated under "recommended operating conditions" is not implied. Exposure to absolute-maximum-rated conditions for extended periods may affect device reliability.
- (2) The input negative-voltage and output voltage ratings may be exceeded if the input and output current ratings are observed.
- (3) This value is limited to 4.6 V maximum.
- (4) The package thermal impedance is calculated in accordance with JESD 51.

RECOMMENDED OPERATING CONDITIONS⁽¹⁾

		MIN	MAX	UNIT
V_{CC}	Supply voltage	1.65	3.6	V
V_{IH}	High-level input voltage	$V_{CC} = 1.65\text{ V to }1.95\text{ V}$		$0.65 \times V_{CC}$
		$V_{CC} = 2.3\text{ V to }2.7\text{ V}$		1.7
		$V_{CC} = 2.7\text{ V to }3.6\text{ V}$		2
V_{IL}	Low-level input voltage	$V_{CC} = 1.65\text{ V to }1.95\text{ V}$		$0.35 \times V_{CC}$
		$V_{CC} = 2.3\text{ V to }2.7\text{ V}$		0.7
		$V_{CC} = 2.7\text{ V to }3.6\text{ V}$		0.8
V_I	Input voltage	0	V_{CC}	V
V_O	Output voltage	0	V_{CC}	V
I_{OH}	High-level output current	$V_{CC} = 1.65\text{ V}$		-2
		$V_{CC} = 2.3\text{ V}$		-6
		$V_{CC} = 2.7\text{ V}$		-8
		$V_{CC} = 3\text{ V}$		-12
I_{OL}	Low-level output current	$V_{CC} = 1.65\text{ V}$		2
		$V_{CC} = 2.3\text{ V}$		6
		$V_{CC} = 2.7\text{ V}$		8
		$V_{CC} = 3\text{ V}$		12
$\Delta t/\Delta v$	Input transition rise or fall rate			10 ns/V
T_A	Operating free-air temperature	-40	85	°C

- (1) All unused control inputs of the device must be held at V_{CC} or GND to ensure proper device operation. Refer to the TI application report, *Implications of Slow or Floating CMOS Inputs*, literature number SCBA004.

SN74ALVCH162334
16-BIT UNIVERSAL BUS DRIVER
WITH 3-STATE OUTPUTS

SCES120H–JULY 1997–REVISED SEPTEMBER 2004

ELECTRICAL CHARACTERISTICS

over recommended operating free-air temperature range (unless otherwise noted)

PARAMETER		TEST CONDITIONS	V _{CC}	MIN	TYP ⁽¹⁾	MAX	UNIT
V _{OH}		I _{OH} = -100 μA	1.65 V to 3.6 V	V _{CC} - 0.2			V
		I _{OH} = -2 mA	1.65 V	1.2			
		I _{OH} = -4 mA	2.3 V	1.9			
		I _{OH} = -6 mA	2.3 V	1.7			
			3 V	2.4			
		I _{OH} = -8 mA	2.7 V	2			
V _{OL}		I _{OL} = 100 μA	1.65 V to 3.6 V			0.2	V
		I _{OL} = 2 mA	1.65 V			0.45	
		I _{OL} = 4 mA	2.3 V			0.4	
		I _{OL} = 6 mA	2.3 V			0.55	
			3 V			0.55	
		I _{OL} = 8 mA	2.7 V			0.6	
	I _{OL} = 12 mA	3 V			0.8		
I _I		V _I = V _{CC} or GND	3.6 V			±5	μA
I _{I(hold)}		V _I = 0.58 V	1.65 V	25			μA
		V _I = 1.07 V	1.65 V	-25			
		V _I = 0.7 V	2.3 V	45			
		V _I = 1.7 V	2.3 V	-45			
		V _I = 0.8 V	3 V	75			
		V _I = 2 V	3 V	-75			
		V _I = 0 to 3.6 V ⁽²⁾	3.6 V			±500	
I _{OZ}		V _O = V _{CC} or GND	3.6 V			±10	μA
I _{CC}		V _I = V _{CC} or GND, I _O = 0	3.6 V			40	μA
ΔI _{CC}		One input at V _{CC} - 0.6 V, Other inputs at V _{CC} or GND	3 V to 3.6 V			750	μA
C _i	Control inputs	V _I = V _{CC} or GND	3.3 V	5.5			pF
	Data inputs			6			
C _o	Outputs	V _O = V _{CC} or GND	3.3 V	8			pF

(1) All typical values are at V_{CC} = 3.3 V, T_A = 25°C.

(2) This is the bus-hold maximum dynamic current. It is the minimum overdrive current required to switch the input from one state to another.

TIMING REQUIREMENTS

over recommended operating free-air temperature range (unless otherwise noted) (see Figure 1 through Figure 3)

		$V_{CC} = 1.8\text{ V}$		$V_{CC} = 2.5\text{ V} \pm 0.2\text{ V}$		$V_{CC} = 2.7\text{ V}$		$V_{CC} = 3.3\text{ V} \pm 0.3\text{ V}$		UNIT	
		MIN	MAX	MIN	MAX	MIN	MAX	MIN	MAX		
f_{clock}	Clock frequency	(1)		150		150		150		MHz	
t_w	Pulse duration	\overline{LE} low		(1)		3.3		3.3		ns	
		CLK high or low		(1)		3.3		3.3			
t_{su}	Setup time	Data before CLK \uparrow		(1)		1.4		1.7		ns	
		Data before $\overline{LE}\uparrow$	CLK high		(1)		1.2		1.6		
			CLK low		(1)		1.4		1.5		
t_h	Hold time	Data after CLK \uparrow		(1)		0.9		0.8		ns	
		Data after $\overline{LE}\uparrow$	CLK high or low		(1)		1.2		1.1		

(1) This information was not available at the time of publication.

SWITCHING CHARACTERISTICS

over recommended operating free-air temperature range (unless otherwise noted) (see Figure 1 through Figure 3)

PARAMETER	FROM (INPUT)	TO (OUTPUT)	$V_{CC} = 1.8\text{ V}$		$V_{CC} = 2.5\text{ V} \pm 0.2\text{ V}$		$V_{CC} = 2.7\text{ V}$		$V_{CC} = 3.3\text{ V} \pm 0.3\text{ V}$		UNIT
			MIN	TYP	MIN	MAX	MIN	MAX	MIN	MAX	
f_{max}			(1)		150		150		150		MHz
t_{pd}	A	Y	(1)		1	3.9	4.5		1.1	3.9	ns
	\overline{LE}		(1)		1	5	6		1.3	5	
	CLK		(1)		1	4.9	5.4		1	4.9	
t_{en}	\overline{OE}	Y	(1)		1	5.4	6.4		1.1	5.4	ns
t_{dis}	\overline{OE}	Y	(1)		1	5	5.1		1.7	5	ns

(1) This information was not available at the time of publication.

OPERATING CHARACTERISTICS

$T_A = 25^\circ\text{C}$

PARAMETER		TEST CONDITIONS	$V_{CC} = 1.8\text{ V}$	$V_{CC} = 2.5\text{ V}$	$V_{CC} = 3.3\text{ V}$	UNIT
			TYP	TYP	TYP	
C_{pd}	Power dissipation capacitance	$C_L = 0, \quad f = 10\text{ MHz}$	(1)	32	37	pF
	Outputs enabled		(1)	7	11.5	
	Outputs disabled					

(1) This information was not available at the time of publication.

PARAMETER MEASUREMENT INFORMATION

$V_{CC} = 1.8\text{ V}$

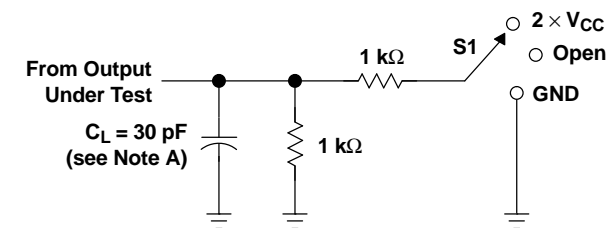

LOAD CIRCUIT

TEST	S1
t_{pd}	Open
t_{PLZ}/t_{PZL}	$2 \times V_{CC}$
t_{PHZ}/t_{PZH}	GND

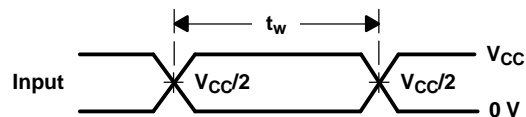
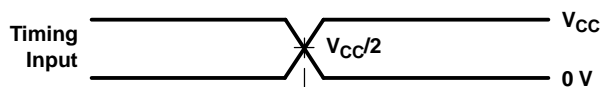

VOLTAGE WAVEFORMS
 PULSE DURATION

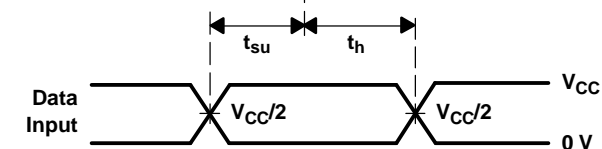

VOLTAGE WAVEFORMS
 SETUP AND HOLD TIMES

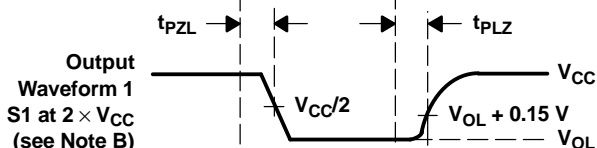
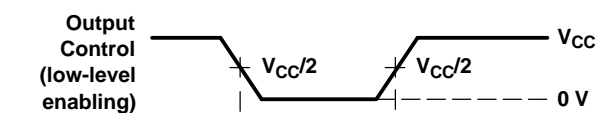

VOLTAGE WAVEFORMS
 PROPAGATION DELAY TIMES

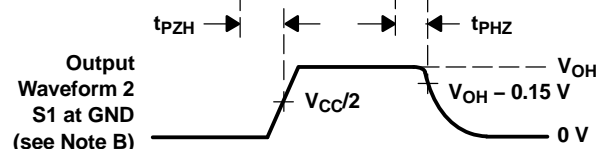

VOLTAGE WAVEFORMS
 ENABLE AND DISABLE TIMES

- NOTES: A. C_L includes probe and jig capacitance.
 B. Waveform 1 is for an output with internal conditions such that the output is low, except when disabled by the output control. Waveform 2 is for an output with internal conditions such that the output is high, except when disabled by the output control.
 C. All input pulses are supplied by generators having the following characteristics: $PRR \leq 10\text{ MHz}$, $Z_O = 50\ \Omega$, $t_r \leq 2\text{ ns}$, $t_f \leq 2\text{ ns}$.
 D. The outputs are measured one at a time, with one transition per measurement.
 E. t_{PLZ} and t_{PHZ} are the same as t_{dis} .
 F. t_{PZL} and t_{PZH} are the same as t_{en} .
 G. t_{PLH} and t_{PHL} are the same as t_{pd} .

Figure 1. Load Circuit and Voltage Waveforms

PARAMETER MEASUREMENT INFORMATION

$V_{CC} = 2.5\text{ V} \pm 0.2\text{ V}$

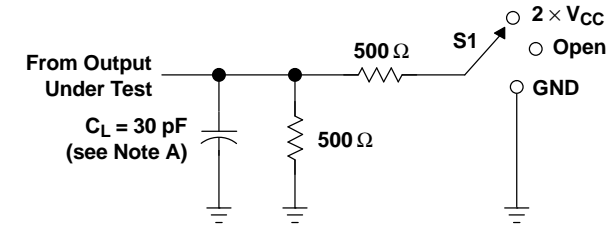

LOAD CIRCUIT

TEST	S1
t_{pd}	Open
t_{PLZ}/t_{PZL}	2 \times V_{CC}
t_{PHZ}/t_{PZH}	GND

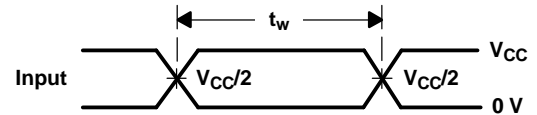
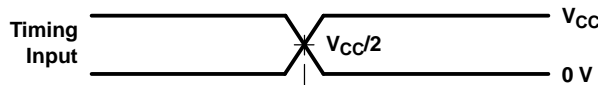

VOLTAGE WAVEFORMS
PULSE DURATION

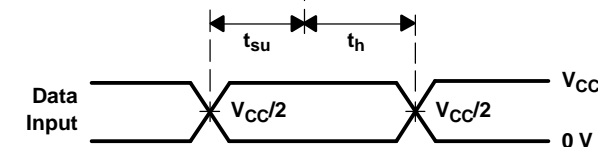

VOLTAGE WAVEFORMS
SETUP AND HOLD TIMES

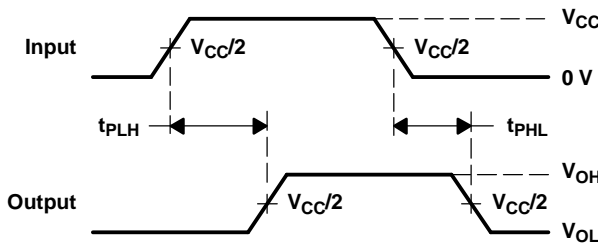
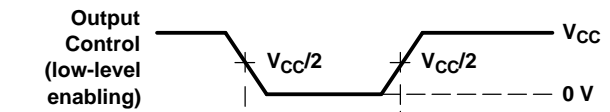

VOLTAGE WAVEFORMS
PROPAGATION DELAY TIMES

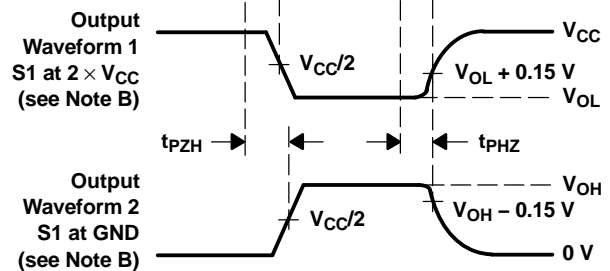

VOLTAGE WAVEFORMS
ENABLE AND DISABLE TIMES

- NOTES: A. C_L includes probe and jig capacitance.
B. Waveform 1 is for an output with internal conditions such that the output is low, except when disabled by the output control. Waveform 2 is for an output with internal conditions such that the output is high, except when disabled by the output control.
C. All input pulses are supplied by generators having the following characteristics: $PRR \leq 10\text{ MHz}$, $Z_O = 50\ \Omega$, $t_r \leq 2\text{ ns}$, $t_f \leq 2\text{ ns}$.
D. The outputs are measured one at a time, with one transition per measurement.
E. t_{PLZ} and t_{PHZ} are the same as t_{dis} .
F. t_{PZL} and t_{PZH} are the same as t_{en} .
G. t_{PLH} and t_{PHL} are the same as t_{pd} .

Figure 2. Load Circuit and Voltage Waveforms

PARAMETER MEASUREMENT INFORMATION
 $V_{CC} = 2.7\text{ V AND } 3.3\text{ V} \pm 0.3\text{ V}$

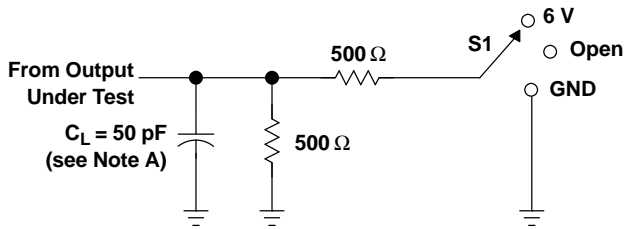

LOAD CIRCUIT

TEST	S1
t_{pd}	Open
t_{PLZ}/t_{PZL}	6 V
t_{PHZ}/t_{PZH}	GND

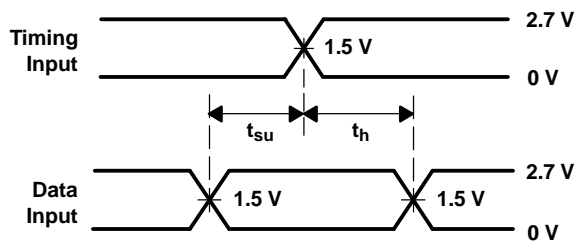

VOLTAGE WAVEFORMS
SETUP AND HOLD TIMES

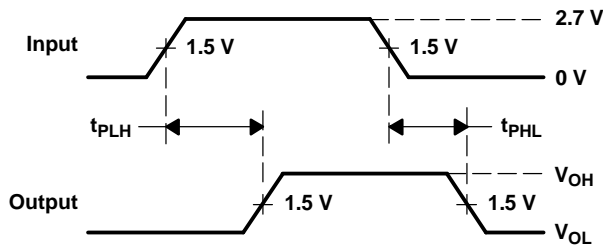

VOLTAGE WAVEFORMS
PROPAGATION DELAY TIMES

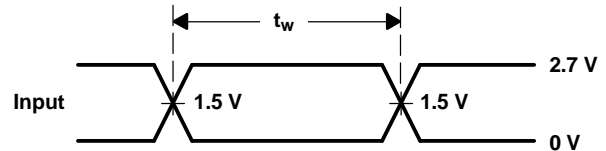

VOLTAGE WAVEFORMS
PULSE DURATION

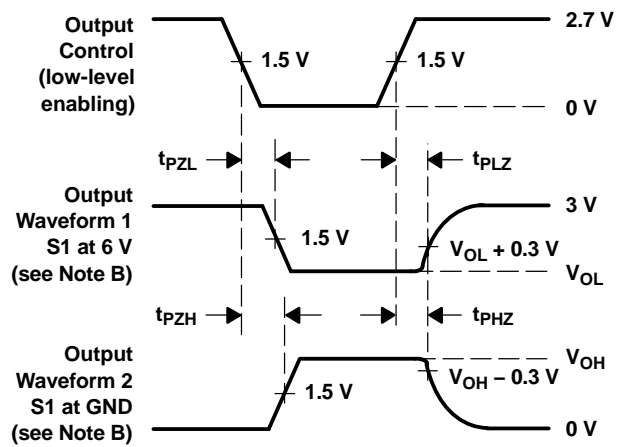

VOLTAGE WAVEFORMS
ENABLE AND DISABLE TIMES

- NOTES: A. C_L includes probe and jig capacitance.
B. Waveform 1 is for an output with internal conditions such that the output is low, except when disabled by the output control. Waveform 2 is for an output with internal conditions such that the output is high, except when disabled by the output control.
C. All input pulses are supplied by generators having the following characteristics: $PRR \leq 10\text{ MHz}$, $Z_O = 50\ \Omega$, $t_r \leq 2.5\text{ ns}$, $t_f \leq 2.5\text{ ns}$.
D. The outputs are measured one at a time, with one transition per measurement.
E. t_{PLZ} and t_{PHZ} are the same as t_{dis} .
F. t_{PZL} and t_{PZH} are the same as t_{en} .
G. t_{PLH} and t_{PHL} are the same as t_{pd} .

Figure 3. Load Circuit and Voltage Waveforms

PACKAGING INFORMATION

Orderable Device	Status (1)	Package Type	Package Drawing	Pins	Package Qty	Eco Plan (2)	Lead finish/ Ball material (6)	MSL Peak Temp (3)	Op Temp (°C)	Device Marking (4/5)	Samples
SN74ALVCH162334DL	ACTIVE	SSOP	DL	48	25	RoHS & Green	NIPDAU	Level-1-260C-UNLIM	-40 to 85	ALVCH162334	Samples
SN74ALVCH162334GR	ACTIVE	TSSOP	DGG	48	2000	RoHS & Green	NIPDAU	Level-1-260C-UNLIM	-40 to 85	ALVCH162334	Samples
SN74ALVCH162334VR	ACTIVE	TVSOP	DGV	48	2000	RoHS & Green	NIPDAU	Level-1-260C-UNLIM	-40 to 85	VH2334	Samples

(1) The marketing status values are defined as follows:

ACTIVE: Product device recommended for new designs.

LIFEBUY: TI has announced that the device will be discontinued, and a lifetime-buy period is in effect.

NRND: Not recommended for new designs. Device is in production to support existing customers, but TI does not recommend using this part in a new design.

PREVIEW: Device has been announced but is not in production. Samples may or may not be available.

OBSOLETE: TI has discontinued the production of the device.

(2) **RoHS:** TI defines "RoHS" to mean semiconductor products that are compliant with the current EU RoHS requirements for all 10 RoHS substances, including the requirement that RoHS substance do not exceed 0.1% by weight in homogeneous materials. Where designed to be soldered at high temperatures, "RoHS" products are suitable for use in specified lead-free processes. TI may reference these types of products as "Pb-Free".

RoHS Exempt: TI defines "RoHS Exempt" to mean products that contain lead but are compliant with EU RoHS pursuant to a specific EU RoHS exemption.

Green: TI defines "Green" to mean the content of Chlorine (Cl) and Bromine (Br) based flame retardants meet JS709B low halogen requirements of <=1000ppm threshold. Antimony trioxide based flame retardants must also meet the <=1000ppm threshold requirement.

(3) MSL, Peak Temp. - The Moisture Sensitivity Level rating according to the JEDEC industry standard classifications, and peak solder temperature.

(4) There may be additional marking, which relates to the logo, the lot trace code information, or the environmental category on the device.

(5) Multiple Device Markings will be inside parentheses. Only one Device Marking contained in parentheses and separated by a "~" will appear on a device. If a line is indented then it is a continuation of the previous line and the two combined represent the entire Device Marking for that device.

(6) Lead finish/Ball material - Orderable Devices may have multiple material finish options. Finish options are separated by a vertical ruled line. Lead finish/Ball material values may wrap to two lines if the finish value exceeds the maximum column width.

Important Information and Disclaimer:The information provided on this page represents TI's knowledge and belief as of the date that it is provided. TI bases its knowledge and belief on information provided by third parties, and makes no representation or warranty as to the accuracy of such information. Efforts are underway to better integrate information from third parties. TI has taken and continues to take reasonable steps to provide representative and accurate information but may not have conducted destructive testing or chemical analysis on incoming materials and chemicals. TI and TI suppliers consider certain information to be proprietary, and thus CAS numbers and other limited information may not be available for release.

In no event shall TI's liability arising out of such information exceed the total purchase price of the TI part(s) at issue in this document sold by TI to Customer on an annual basis.

TAPE AND REEL INFORMATION

QUADRANT ASSIGNMENTS FOR PIN 1 ORIENTATION IN TAPE



*All dimensions are nominal

Device	Package Type	Package Drawing	Pins	SPQ	Reel Diameter (mm)	Reel Width W1 (mm)	A0 (mm)	B0 (mm)	K0 (mm)	P1 (mm)	W (mm)	Pin1 Quadrant
SN74ALVCH162334GR	TSSOP	DGG	48	2000	330.0	24.4	8.6	13.0	1.8	12.0	24.0	Q1
SN74ALVCH162334VR	TVSOP	DGV	48	2000	330.0	16.4	7.1	10.2	1.6	12.0	16.0	Q1

TAPE AND REEL BOX DIMENSIONS

*All dimensions are nominal

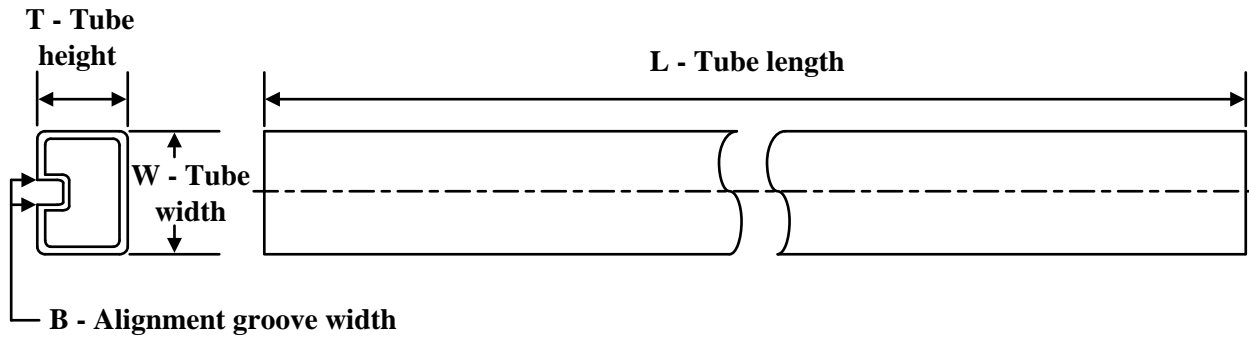
Device	Package Type	Package Drawing	Pins	SPQ	Length (mm)	Width (mm)	Height (mm)
SN74ALVCH162334GR	TSSOP	DGG	48	2000	367.0	367.0	45.0
SN74ALVCH162334VR	TVSOP	DGV	48	2000	356.0	356.0	35.0

TUBE

*All dimensions are nominal

Device	Package Name	Package Type	Pins	SPQ	L (mm)	W (mm)	T (μm)	B (mm)
SN74ALVCH162334DL	DL	SSOP	48	25	473.7	14.24	5110	7.87

DGV (R-PDSO-G**)

PLASTIC SMALL-OUTLINE

24 PINS SHOWN

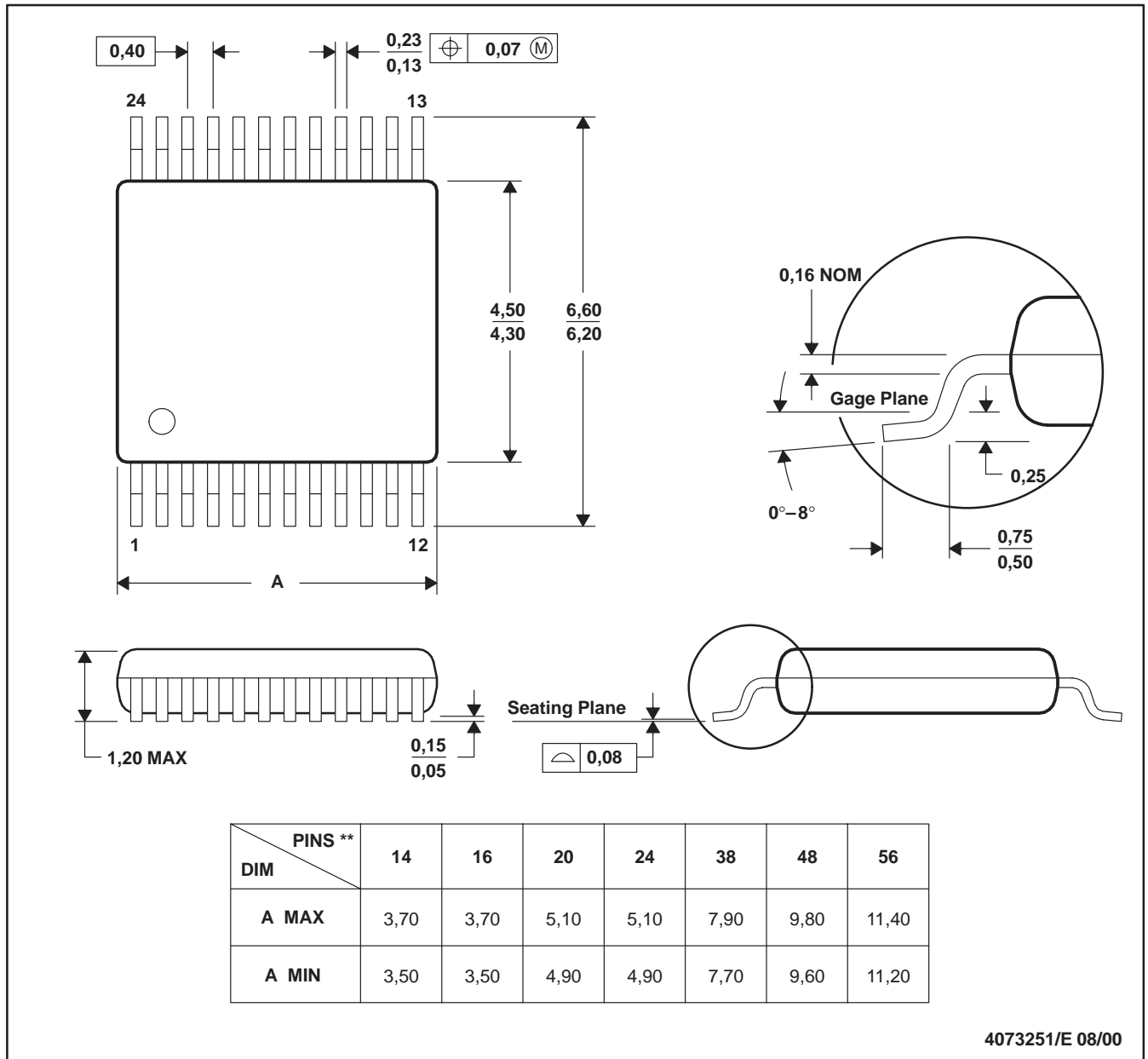

4073251/E 08/00

- NOTES: A. All linear dimensions are in millimeters.
 B. This drawing is subject to change without notice.
 C. Body dimensions do not include mold flash or protrusion, not to exceed 0,15 per side.
 D. Falls within JEDEC: 24/48 Pins – MO-153
 14/16/20/56 Pins – MO-194

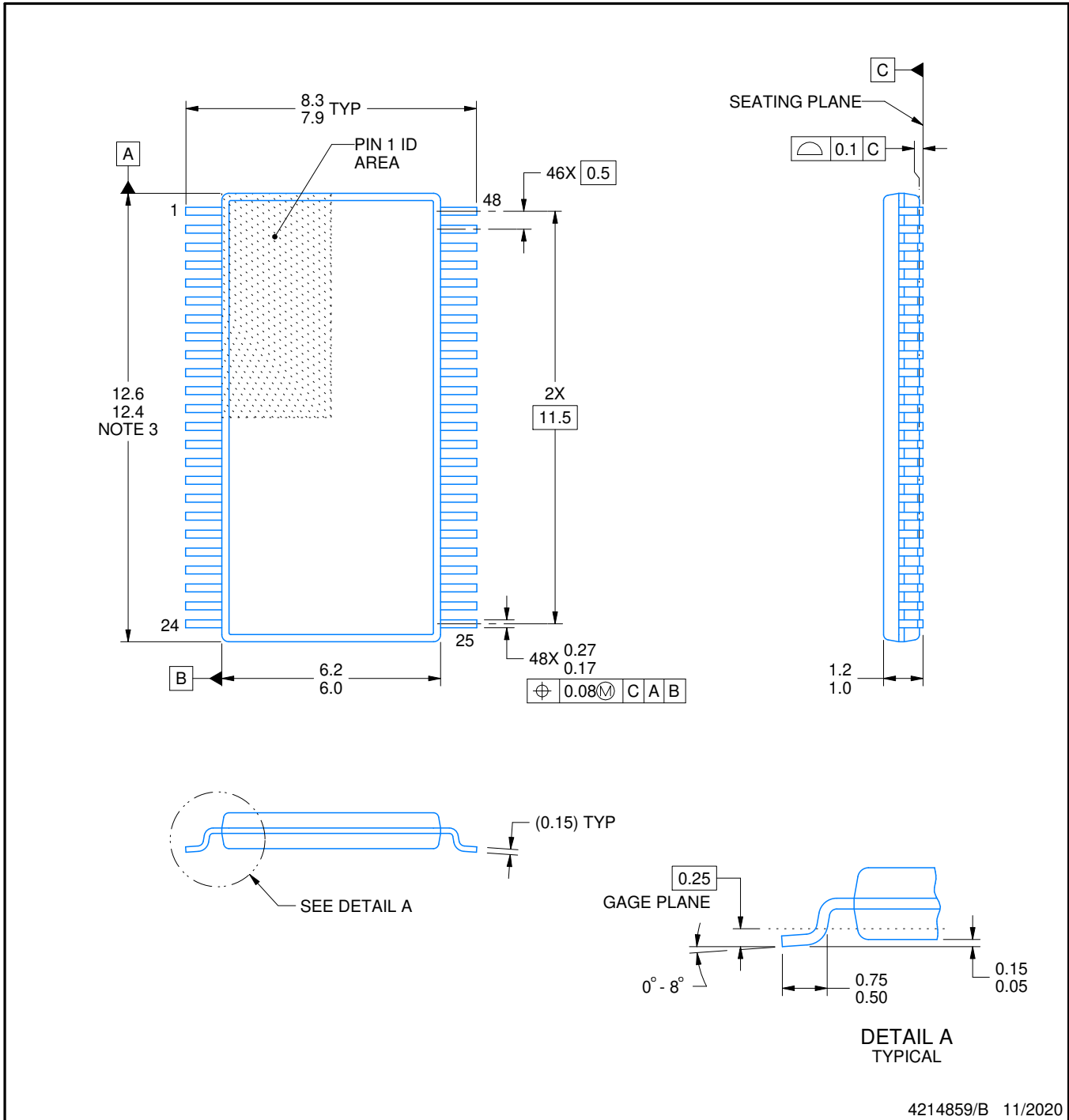

4214859/B 11/2020

NOTES:

1. All linear dimensions are in millimeters. Any dimensions in parenthesis are for reference only. Dimensioning and tolerancing per ASME Y14.5M.
2. This drawing is subject to change without notice.
3. This dimension does not include mold flash, protrusions, or gate burrs. Mold flash, protrusions, or gate burrs shall not exceed 0.15 mm per side.
4. Reference JEDEC registration MO-153.

EXAMPLE BOARD LAYOUT

DGG0048A

TSSOP - 1.2 mm max height

SMALL OUTLINE PACKAGE

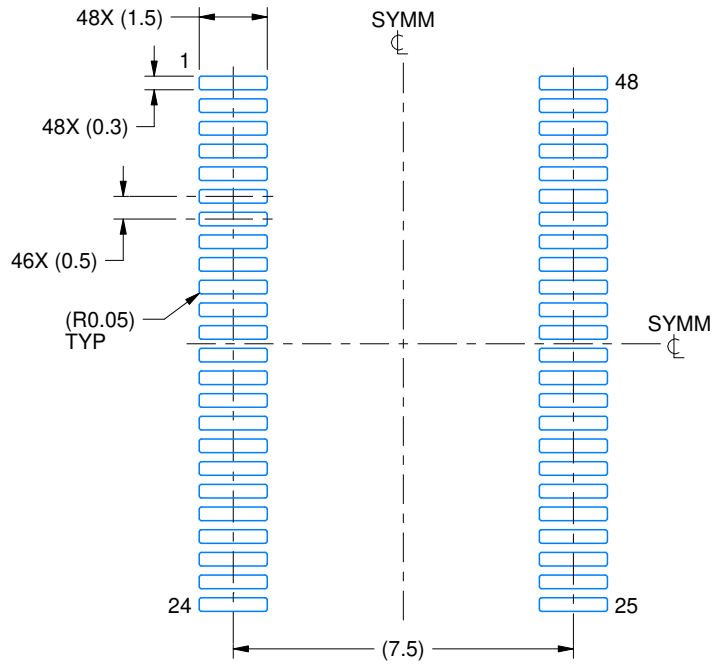

LAND PATTERN EXAMPLE
SCALE:6X

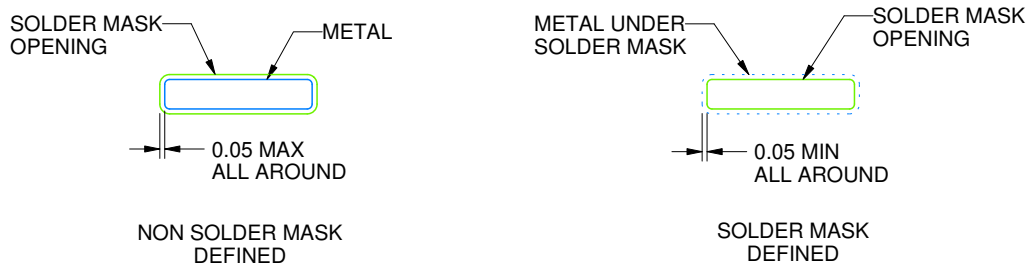

SOLDER MASK DETAILS

4214859/B 11/2020

NOTES: (continued)

5. Publication IPC-7351 may have alternate designs.
6. Solder mask tolerances between and around signal pads can vary based on board fabrication site.

EXAMPLE STENCIL DESIGN

DGG0048A

TSSOP - 1.2 mm max height

SMALL OUTLINE PACKAGE

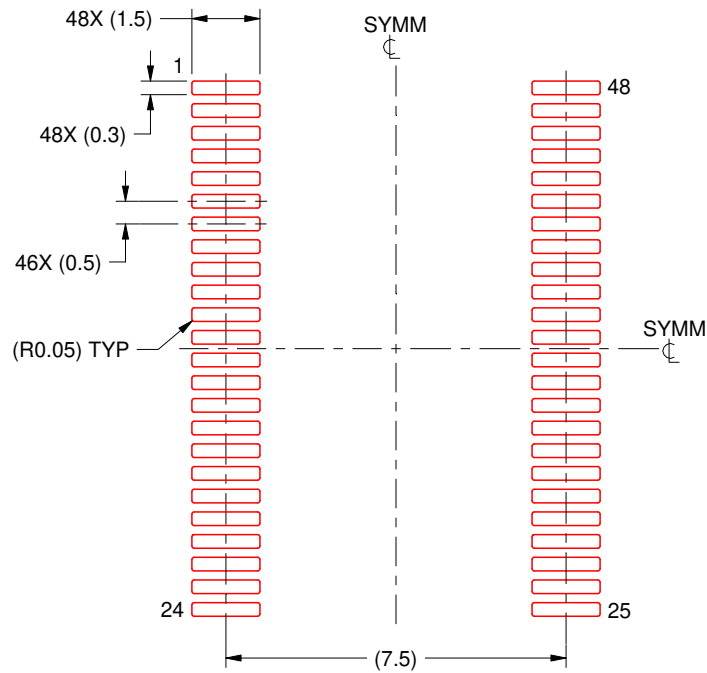

SOLDER PASTE EXAMPLE
BASED ON 0.125 mm THICK STENCIL
SCALE:6X

4214859/B 11/2020

NOTES: (continued)

7. Laser cutting apertures with trapezoidal walls and rounded corners may offer better paste release. IPC-7525 may have alternate design recommendations.
8. Board assembly site may have different recommendations for stencil design.

DGG (R-PDSO-G**)

PLASTIC SMALL-OUTLINE PACKAGE

48 PINS SHOWN



- NOTES: A. All linear dimensions are in millimeters.
 B. This drawing is subject to change without notice.
 C. Body dimensions do not include mold protrusion not to exceed 0,15.
 D. Falls within JEDEC MO-153

MECHANICAL DATA

DL (R-PDSO-G48)

PLASTIC SMALL-OUTLINE PACKAGE

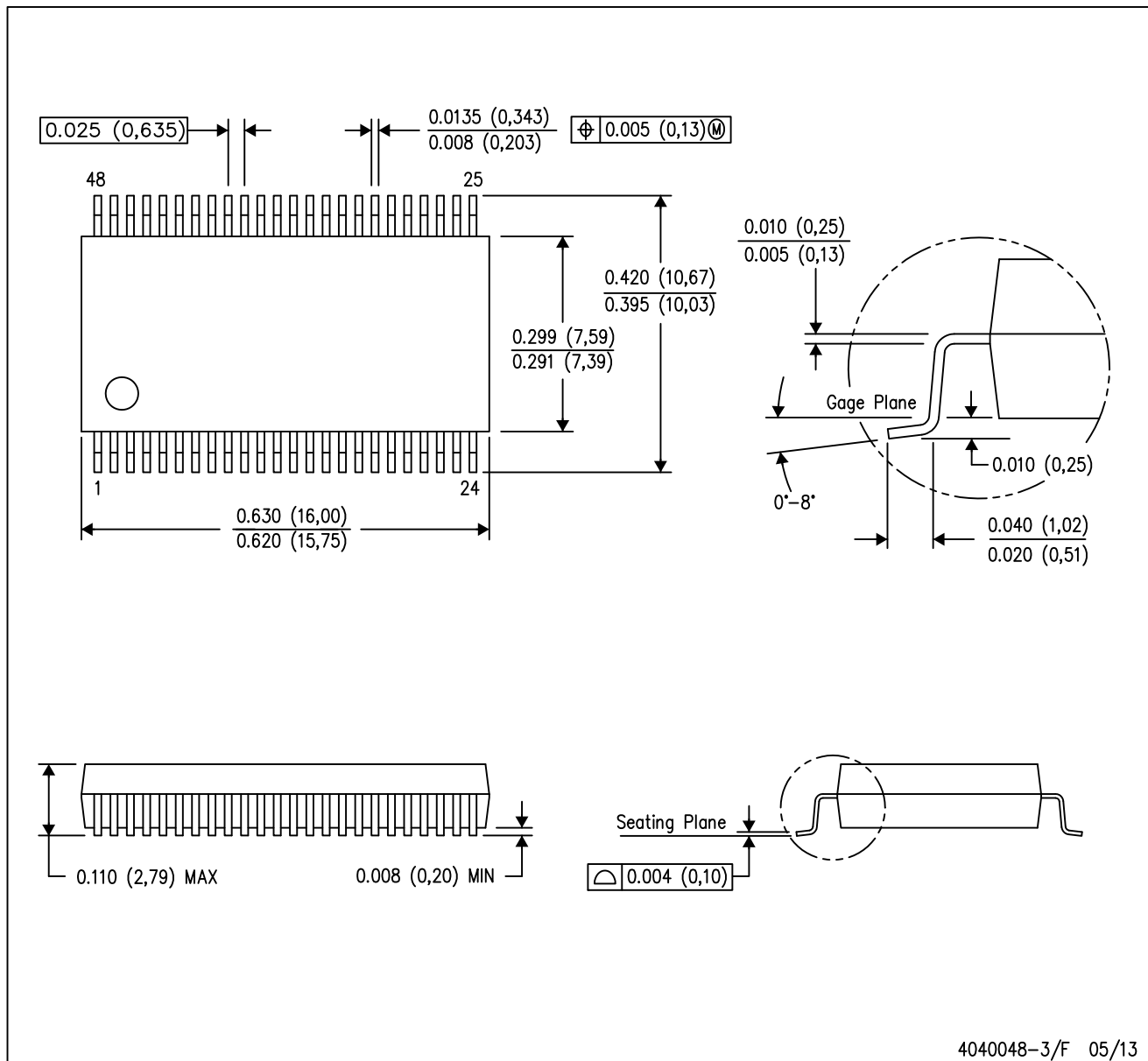

- NOTES:
- All linear dimensions are in inches (millimeters).
 - This drawing is subject to change without notice.
 - Body dimensions do not include mold flash or protrusion not to exceed 0.006 (0,15).
 - Falls within JEDEC MO-118

PowerPAD is a trademark of Texas Instruments.

IMPORTANT NOTICE AND DISCLAIMER

TI PROVIDES TECHNICAL AND RELIABILITY DATA (INCLUDING DATA SHEETS), DESIGN RESOURCES (INCLUDING REFERENCE DESIGNS), APPLICATION OR OTHER DESIGN ADVICE, WEB TOOLS, SAFETY INFORMATION, AND OTHER RESOURCES "AS IS" AND WITH ALL FAULTS, AND DISCLAIMS ALL WARRANTIES, EXPRESS AND IMPLIED, INCLUDING WITHOUT LIMITATION ANY IMPLIED WARRANTIES OF MERCHANTABILITY, FITNESS FOR A PARTICULAR PURPOSE OR NON-INFRINGEMENT OF THIRD PARTY INTELLECTUAL PROPERTY RIGHTS.

These resources are intended for skilled developers designing with TI products. You are solely responsible for (1) selecting the appropriate TI products for your application, (2) designing, validating and testing your application, and (3) ensuring your application meets applicable standards, and any other safety, security, regulatory or other requirements.

These resources are subject to change without notice. TI grants you permission to use these resources only for development of an application that uses the TI products described in the resource. Other reproduction and display of these resources is prohibited. No license is granted to any other TI intellectual property right or to any third party intellectual property right. TI disclaims responsibility for, and you will fully indemnify TI and its representatives against, any claims, damages, costs, losses, and liabilities arising out of your use of these resources.

TI's products are provided subject to [TI's Terms of Sale](#) or other applicable terms available either on ti.com or provided in conjunction with such TI products. TI's provision of these resources does not expand or otherwise alter TI's applicable warranties or warranty disclaimers for TI products.

TI objects to and rejects any additional or different terms you may have proposed.

Mailing Address: Texas Instruments, Post Office Box 655303, Dallas, Texas 75265
Copyright © 2022, Texas Instruments Incorporated