

## Thunderbolt IGBT®

The Thunderblot IGBT® is a new generation of high voltage power IGBTs. Using Non- Punch Through Technology, the Thunderblot IGBT® offers superior ruggedness and ultrafast switching speed.

- Low Forward Voltage Drop
- High Freq. Switching to 50KHz
- Low Tail Current
- Ultra Low Leakage Current
- RBSOA and SCSOA Rated

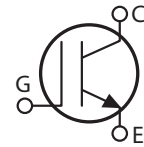
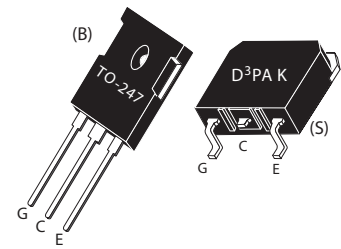

### MAXIMUM RATINGS

 All Ratings:  $T_C = 25^\circ\text{C}$  unless otherwise specified.

Symbol	Parameter	APT15GT120BR_SR(G)	UNIT
$V_{CES}$	Collector-Emitter Voltage	1200	Volts
$V_{GE}$	Gate-Emitter Voltage	$\pm 30$	
$I_{C1}$	Continuous Collector Current @ $T_C = 25^\circ\text{C}$	36	Amps
$I_{C2}$	Continuous Collector Current @ $T_C = 110^\circ\text{C}$	18	
$I_{CM}$	Pulsed Collector Current <sup>1</sup> @ $T_C = 150^\circ\text{C}$	45	
SSOA	Switching Safe Operating Area @ $T_j = 150^\circ\text{C}$	45A @ 960V	
$P_D$	Total Power Dissipation	250	Watts
$T_j, T_{STG}$	Operating and Storage Junction Temperature Range	-55 to 150	°C
$T_L$	Max. Lead Temp. for Soldering: 0.063" from Case for 10 Sec.	300	

### STATIC ELECTRICAL CHARACTERISTICS

Symbol	Characteristic / Test Conditions	MIN	TYP	MAX	Units
$V_{(BR)CES}$	Collector-Emitter Breakdown Voltage ( $V_{GE} = 0V, I_C = 1mA$ )	1200			Volts
$V_{GE(TH)}$	Gate Threshold Voltage ( $V_{CE} = V_{GE}, I_C = 0.6mA, T_j = 25^\circ\text{C}$ )	4.5	5.5	6.5	
$V_{CE(ON)}$	Collector-Emitter On Voltage ( $V_{GE} = 15V, I_C = 15A, T_j = 25^\circ\text{C}$ )	2.5	3.0	3.6	
	Collector-Emitter On Voltage ( $V_{GE} = 15V, I_C = 15A, T_j = 125^\circ\text{C}$ )		3.8		
$I_{CES}$	Collector Cut-off Current ( $V_{CE} = 1200V, V_{GE} = 0V, T_j = 25^\circ\text{C}$ ) <sup>2</sup>			100	$\mu\text{A}$
	Collector Cut-off Current ( $V_{CE} = 1200V, V_{GE} = 0V, T_j = 125^\circ\text{C}$ ) <sup>2</sup>			TBD	
$I_{GES}$	Gate-Emitter Leakage Current ( $V_{GE} = \pm 20V$ )			480	nA

 **CAUTION:** These Devices are Sensitive to Electrostatic Discharge. Proper Handling Procedures Should Be Followed.

DYNAMIC CHARACTERISTICS

APT15GT120BR\_SR(G)

Symbol	Characteristic	Test Conditions	MIN	TYP	MAX	UNIT	
$C_{ies}$	Input Capacitance	Capacitance $V_{GE} = 0V, V_{CE} = 25V$ $f = 1 \text{ MHz}$		1250		pF	
$C_{oes}$	Output Capacitance			100			
$C_{res}$	Reverse Transfer Capacitance			65			
$V_{GEP}$	Gate-to-Emitter Plateau Voltage	Gate Charge $V_{GE} = 15V$ $V_{CE} = 600V$ $I_C = 15A$		10		V	
$Q_g$	Total Gate Charge <sup>3</sup>			105			
$Q_{ge}$	Gate-Emitter Charge			10			
$Q_{gc}$	Gate-Collector ("Miller") Charge			60			
SSOA	Switching Safe Operating Area	$T_J = 150^\circ\text{C}, R_G = 5\Omega, V_{GE} = 15V, L = 100\mu\text{H}, V_{CE} = 960V$	45			A	
$t_{d(on)}$	Turn-on Delay Time	Inductive Switching (25°C) $V_{CC} = 800V$ $V_{GE} = 15V$ $I_C = 15A$ $R_G = 5\Omega$ $T_J = +25^\circ\text{C}$		10		ns	
$t_r$	Current Rise Time			11			
$t_{d(off)}$	Turn-off Delay Time			85			
$t_f$	Current Fall Time			35			
$E_{on1}$	Turn-on Switching Energy <sup>4</sup>				585		$\mu\text{J}$
$E_{on2}$	Turn-on Switching Energy (Diode) <sup>5</sup>				800		
$E_{off}$	Turn-off Switching Energy <sup>6</sup>				260		
$t_{d(on)}$	Turn-on Delay Time		Inductive Switching (125°C) $V_{CC} = 800V$ $V_{GE} = 15V$ $I_C = 15A$ $R_G = 5\Omega$ $T_J = +125^\circ\text{C}$		10		ns
$t_r$	Current Rise Time			11			
$t_{d(off)}$	Turn-off Delay Time			95			
$t_f$	Current Fall Time			42			
$E_{on1}$	Turn-on Switching Energy <sup>4</sup>				590		$\mu\text{J}$
$E_{on2}$	Turn-on Switching Energy (Diode) <sup>5</sup>				1440		
$E_{off}$	Turn-off Switching Energy <sup>6</sup>				340		

THERMAL AND MECHANICAL CHARACTERISTICS

Symbol	Characteristic	MIN	TYP	MAX	UNIT
$R_{\theta JC}$	Junction to Case (IGBT)			.50	$^\circ\text{C/W}$
$R_{\theta JC}$	Junction to Case (DIODE)			N/A	
$W_T$	Package Weight		5.9		gm

- ① Repetitive Rating: Pulse width limited by maximum junction temperature.
- ② For Combi devices,  $I_{ces}$  includes both IGBT and FRED leakages
- ③ See MIL-STD-750 Method 3471.
- ④  $E_{on1}$  is the clamped inductive turn-on energy of the IGBT only, without the effect of a commutating diode reverse recovery current adding to the IGBT turn-on loss. Tested in inductive switching test circuit shown in figure 21, but with a Silicon Carbide diode.
- ⑤  $E_{on2}$  is the clamped inductive turn-on energy that includes a commutating diode reverse recovery current in the IGBT turn-on switching loss. (See Figures 21, 22.)
- ⑥  $E_{off}$  is the clamped inductive turn-off energy measured in accordance with JEDEC standard JESD24-1. (See Figures 21, 23.)

Microsemi Reserves the right to change, without notice, the specifications and information contained herein.

TYPICAL PERFORMANCE CURVES

APT15GT120BR\_SR(G)

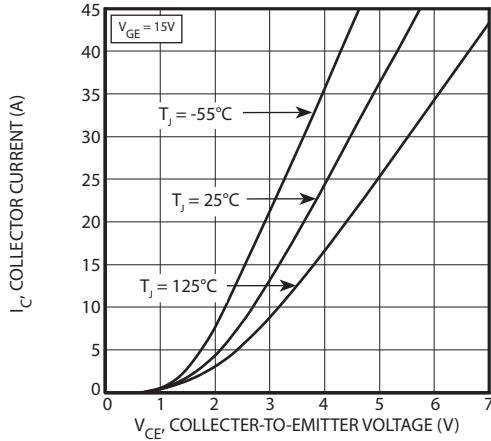

FIGURE 1, Output Characteristics ( $T_j = 25^\circ\text{C}$ )

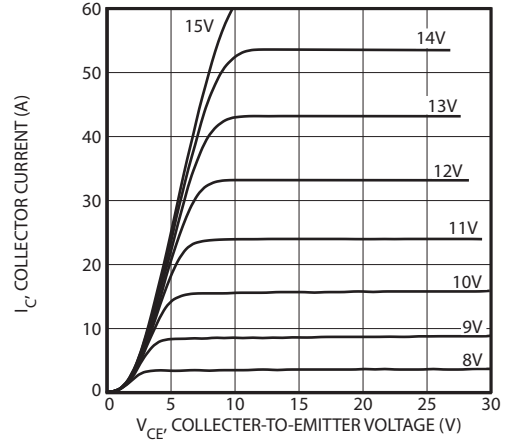

FIGURE 2, Output Characteristics ( $T_j = 125^\circ\text{C}$ )

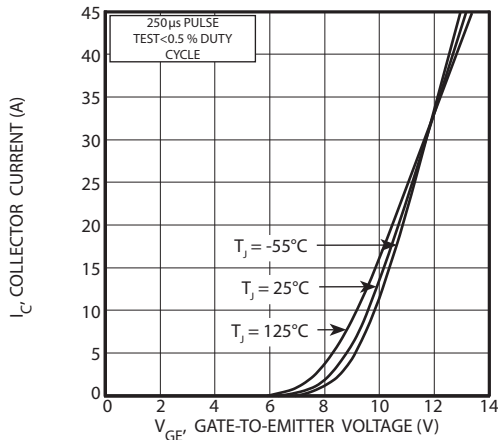

FIGURE 3, Transfer Characteristics

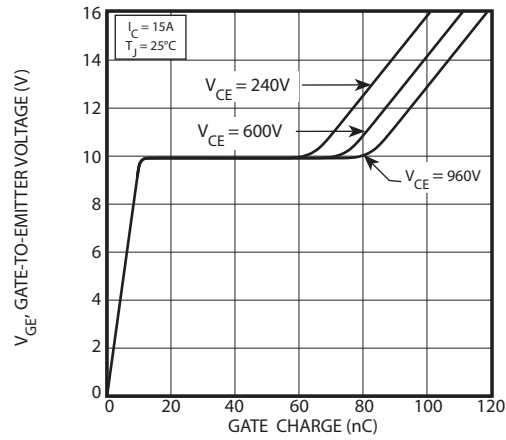

FIGURE 4, Gate Charge

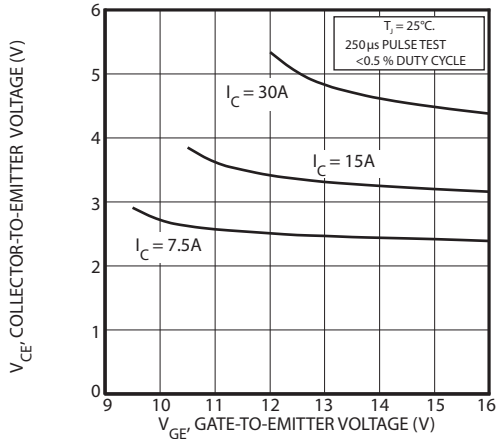

FIGURE 5, On State Voltage vs Gate-to-Emitter Voltage

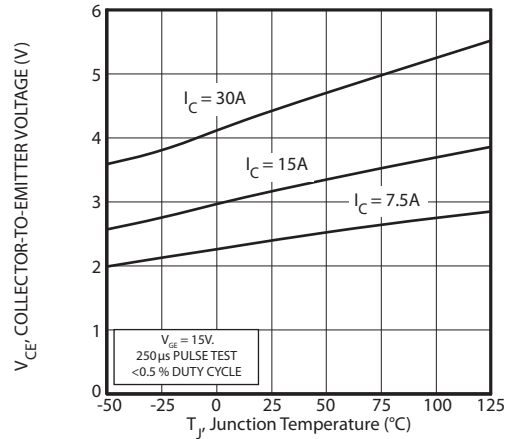

FIGURE 6, On State Voltage vs Junction Temperature

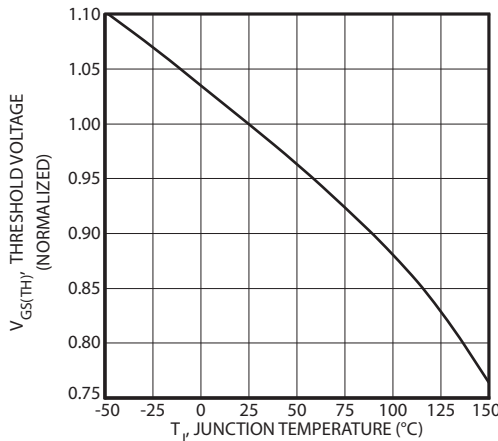

FIGURE 7, Threshold Voltage vs. Junction Temperature

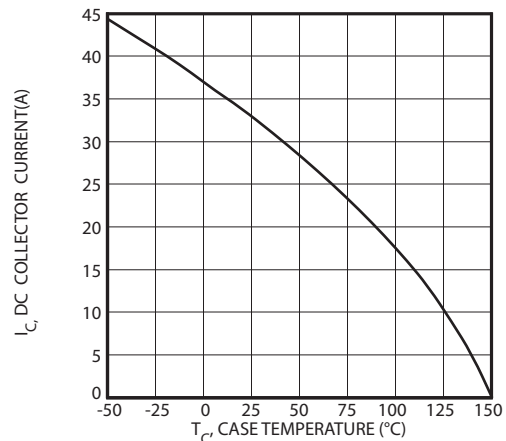

FIGURE 8, DC Collector Current vs Case Temperature

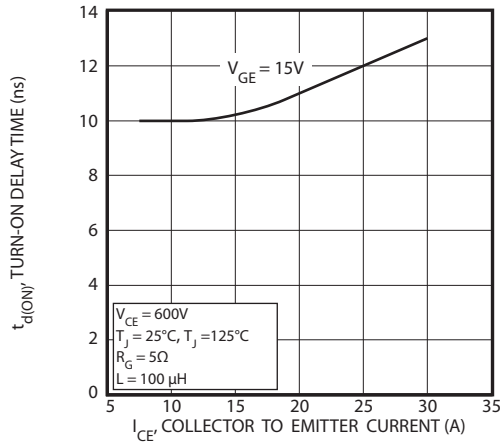

FIGURE 9, Turn-On Delay Time vs Collector Current

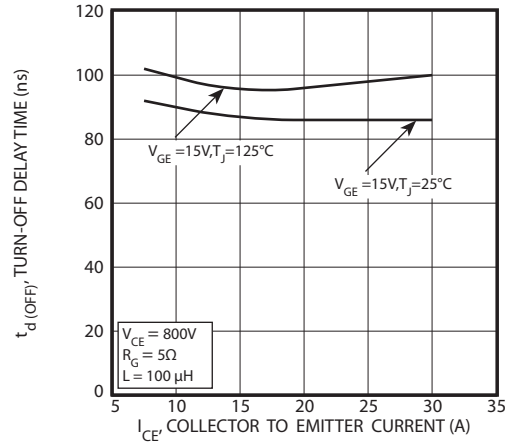

FIGURE 10, Turn-Off Delay Time vs Collector Current

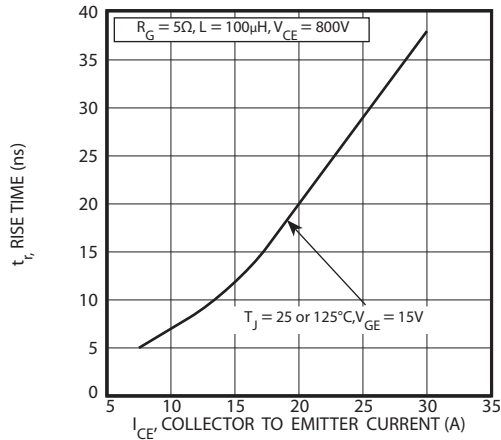

FIGURE 11, Current Rise Time vs Collector Current

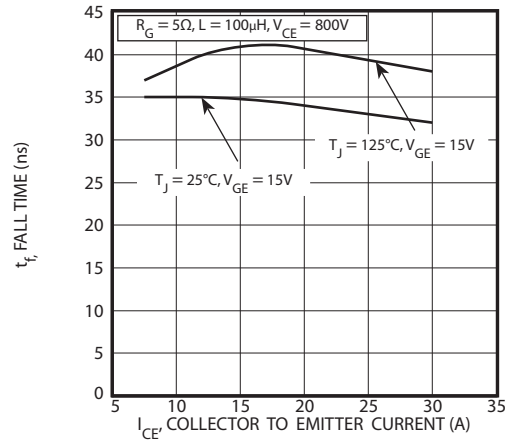

FIGURE 12, Current Fall Time vs Collector Current

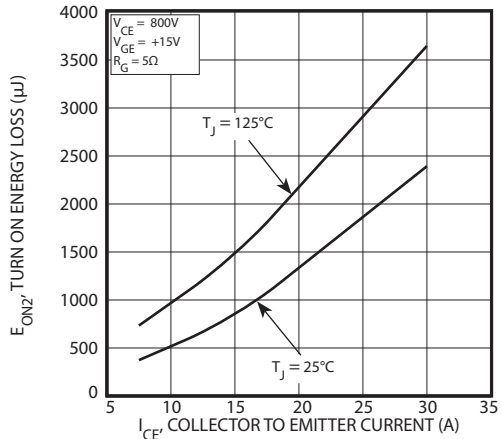

FIGURE 13, Turn-On Energy Loss vs Collector Current

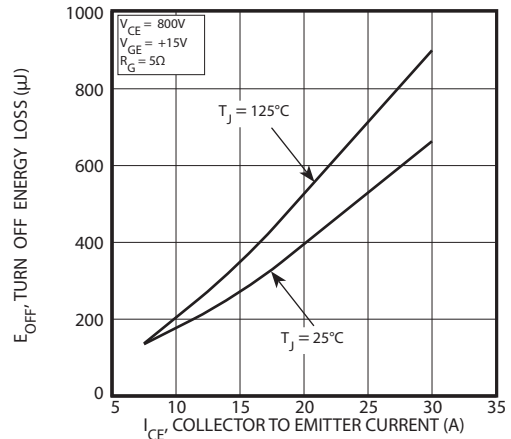

FIGURE 14, Turn Off Energy Loss vs Collector Current

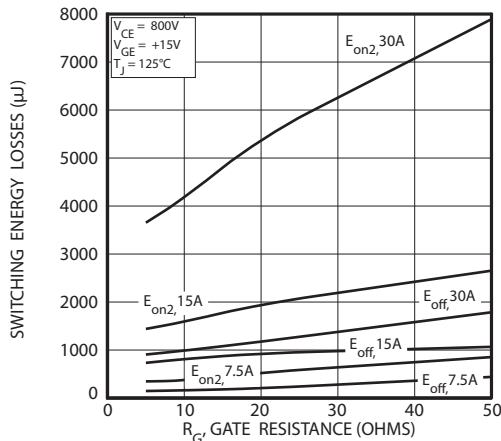

FIGURE 15, Switching Energy Losses vs. Gate Resistance

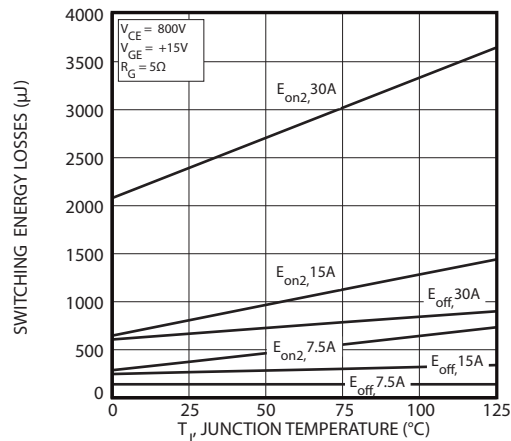

FIGURE 16, Switching Energy Losses vs Junction Temperature

TYPICAL PERFORMANCE CURVES

APT15GT120BR\_SR(G)

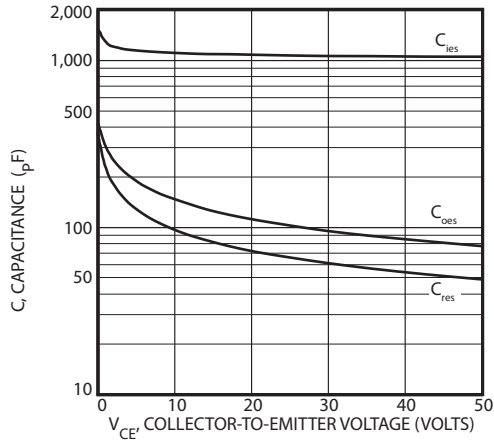

Figure 17, Capacitance vs Collector-To-Emitter Voltage

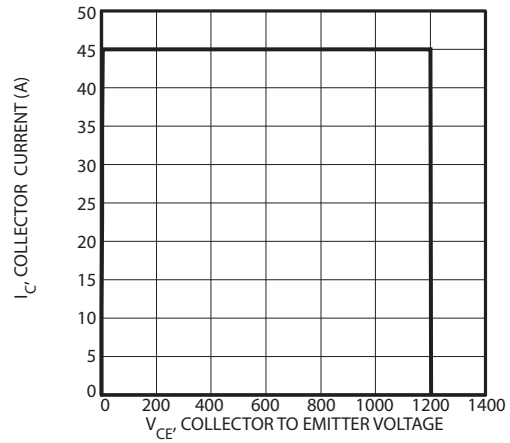

Figure 18, Minimum Switching Safe Operating Area

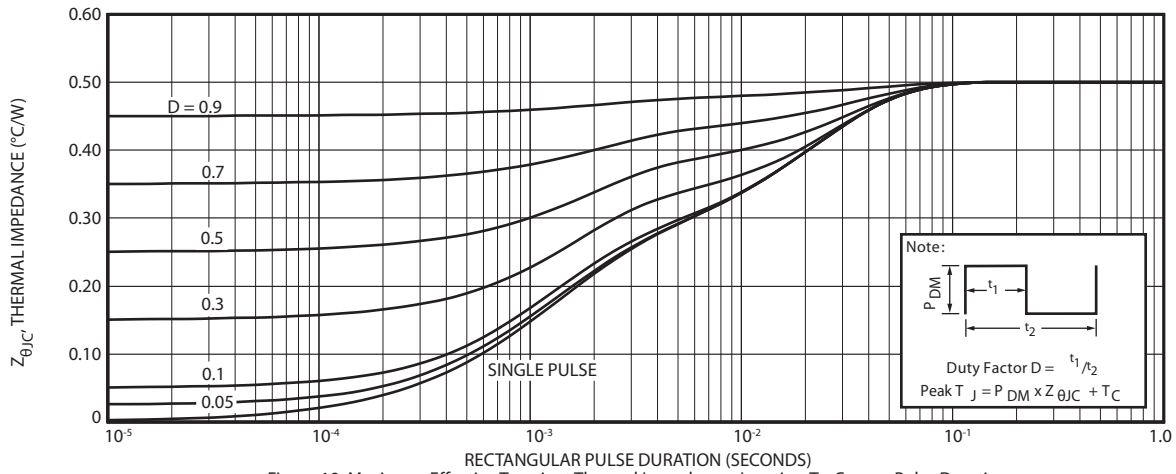

Figure 19, Maximum Effective Transient Thermal Impedance, Junction-To-Case vs Pulse Duration

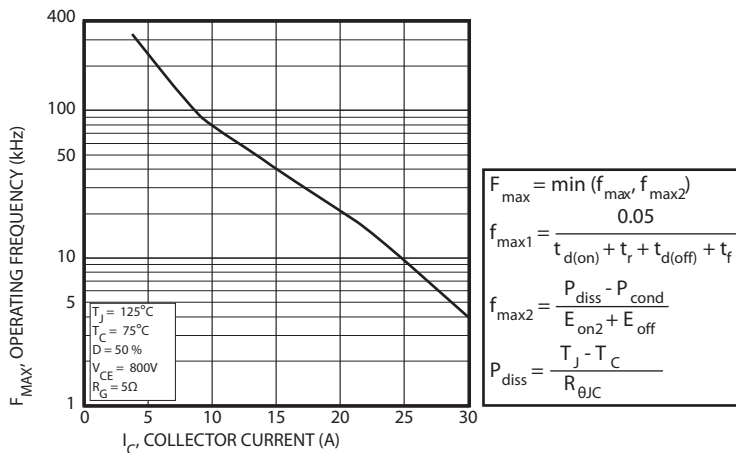

Figure 20, Operating Frequency vs Collector Current

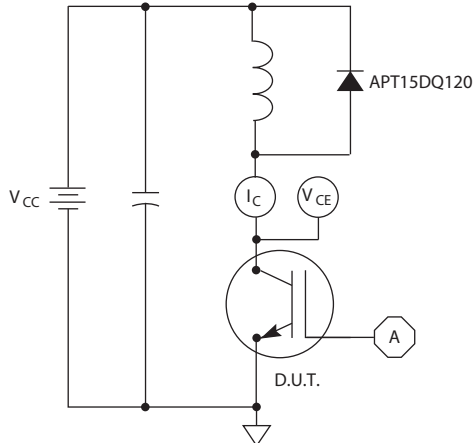

Figure 21, Inductive Switching Test Circuit

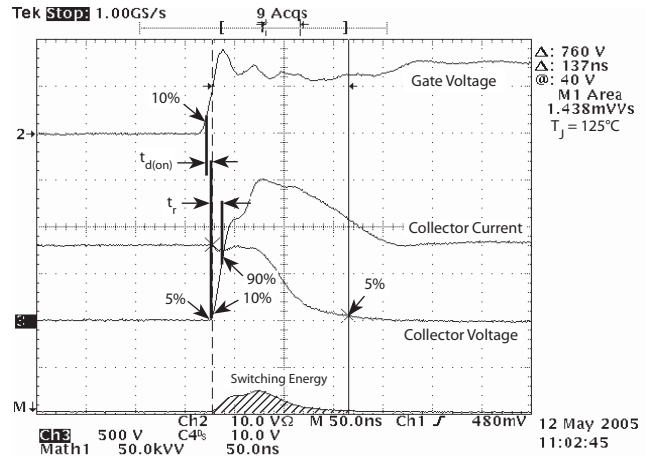

Figure 22, Turn-on Switching Waveforms and Definitions

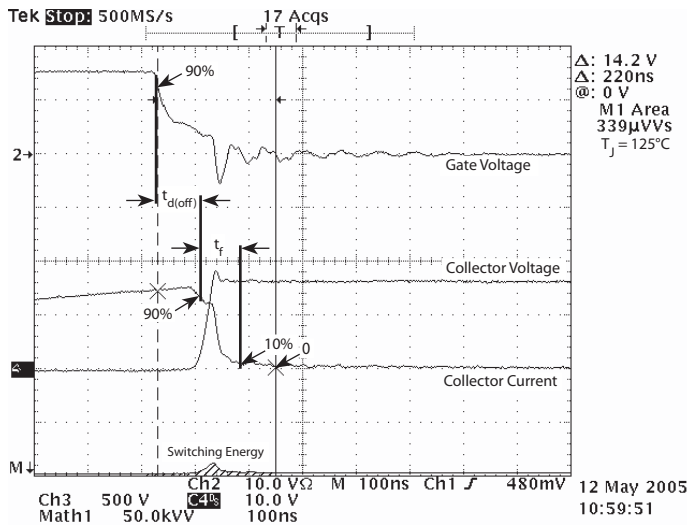
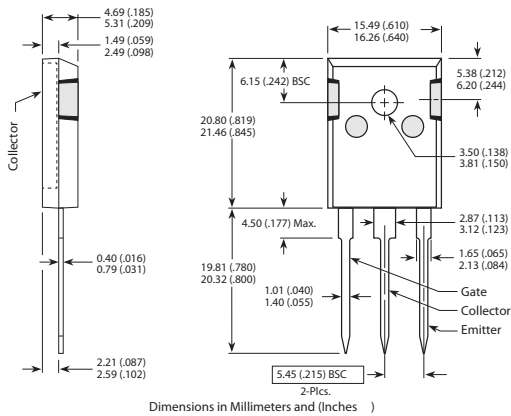

Figure 23, Turn-off Switching Waveforms and Definitions

TO-247 Package Outline

e1 SAC: Tin, Silver, Copper



D<sup>3</sup>PAK Package Outline

e3 SAC: Tin, Silver, Copper

