

**PIM 4328 series Power Interface Module**  
 Input 36-75 V, Output up to 10-12 A / 540-648 W

28701-BMR4550003 Rev C November 2017

© Flex

### Key Features

- Industry standard low profile Quarter-brick  
57.9 x 36.8 x 10.7 mm (2.28 x 1.45 x 0.421 in)
- 400 W at 40 Vin, 480 W at 48 Vin, 540 W at 54 Vin
- High efficiency, typ. 99% at 300 W
- 10 A output current at 70°C 0.5 m/s (100 LFM) airflow
- Low EMI design for CISPR Class B
- Monitoring via I<sup>2</sup>C
- 2250 Vdc input to output isolation
- Optimized for ATCA applications
- Basic insulation according to UL 60950-1
- MTBF 1.8 Mh



### General Characteristics

- Dual power feeds input and enable
- Input transient suppression (IEC & ANSI standards)
- Reverse polarity protection
- Input under voltage shutdown
- Over temperature protection
- Output current protection
- A/B Feed loss alarm
- Inrush protection and hot swap functionality
- Hold-up charge and management
- 12 W dual management power output
- Highly automated manufacturing ensures quality
- ISO 9001/14001 certified supplier



### Safety Approvals



### Design for Environment



Meets requirements in high-temperature lead-free soldering processes.

### Contents

Ordering Information	2
General Information	2
Safety Specification	3
Absolute Maximum Ratings	4
Electrical Specification	
10-12A/ 3.3V, 3.6A/ 5.0V, 0.15A	PIM 4328 P..... 5
Application Circuit Diagram	16
EMC Specification	17
Operating Information	18
Thermal Consideration	20
Connections	21
I <sup>2</sup> C/PM Bus Interface	22
Mechanical Information	25
Soldering Information	26
Delivery Package Information	26
Product Qualification Specification	27

## Technical Specification

**PIM 4328 series Power Interface Module**  
Input 36-75 V, Output up to 10-12 A / 540-648 W

28701-BMR4550003 Rev C November 2017

© Flex

**Ordering Information**

Product program	Output
PIM 4328	10-12A/ 3.3V, 3.6A / 5V, 0.15A

## Product number and Packaging

PIM 4XXX n <sub>1</sub> n <sub>2</sub> n <sub>3</sub> n <sub>4</sub>				
Options	n <sub>1</sub>	n <sub>2</sub>	n <sub>3</sub>	n <sub>4</sub>
Mounting	o			
Function		o		
Lead length			o	
Delivery package information				o

Options	Description
n <sub>1</sub>	P Through hole
n <sub>2</sub>	Analog*
	D Standard config PMBus
	DA Limited I <sup>2</sup> C (Industry standard)
n <sub>3</sub>	5.33 mm *
	LA 3.69 mm
	LB 4.57 mm
n <sub>4</sub>	Soft tray *

Example a through-hole mounted, PMBus logic, standard pin product with tray packaging would be PIM 4328PD.

\* Standard variant (i.e. no option selected).

**General Information****Reliability**

The failure rate ( $\lambda$ ) and mean time between failures (MTBF =  $1/\lambda$ ) is calculated at max output power and an operating ambient temperature ( $T_A$ ) of +40°C. Flex Power Modules uses Telcordia SR-332 Issue 2 Method 1 to calculate the mean steady-state failure rate and standard deviation ( $\sigma$ ).

Telcordia SR-332 Issue 2 also provides techniques to estimate the upper confidence levels of failure rates based on the mean and standard deviation.

Mean steady-state failure rate, $\lambda$	Std. deviation, $\sigma$
531 nFailures/h	47 nFailures/h

MTBF (mean value) for the PIM series = 1.83 Mh.  
MTBF at 90% confidence level = 1.65 Mh

**Compatibility with RoHS requirements**

The products are compatible with the relevant clauses and requirements of the RoHS directive 2002/95/EC and have a maximum concentration value of 0.1% by weight in homogeneous materials for lead, mercury, hexavalent chromium, PBB and PBDE and of 0.01% by weight in homogeneous materials for cadmium.

Exemptions in the RoHS directive utilized in Flex Power Modules products are found in the Statement of Compliance document.

Flex Power Modules fulfills and will continuously fulfill all its obligations under regulation (EC) No 1907/2006 concerning the registration, evaluation, authorization and restriction of chemicals (REACH) as they enter into force and is through product materials declarations preparing for the obligations to communicate information on substances in the products.

**Quality Statement**

The products are designed and manufactured in an industrial environment where quality systems and methods like ISO 9000, Six Sigma, and SPC are intensively in use to boost the continuous improvements strategy. Infant mortality or early failures in the products are screened out and they are subjected to an ATE-based final test. Conservative design rules, design reviews and product qualifications, plus the high competence of an engaged work force, contribute to the high quality of the products.

**Warranty**

Warranty period and conditions are defined in Flex Power Modules General Terms and Conditions of Sale.

**Limitation of Liability**

Flex Power Modules does not make any other warranties, expressed or implied including any warranty of merchantability or fitness for a particular purpose (including, but not limited to, use in life support applications, where malfunctions of product can cause injury to a person's health or life).

**© Flex 2017**

The information and specifications in this technical specification is believed to be correct at the time of publication. However, no liability is accepted for inaccuracies, printing errors or for any consequences thereof. Flex reserves the right to change the contents of this technical specification at any time without prior notice.

## Technical Specification

<b>PIM 4328 series Power Interface Module</b> Input 36-75 V, Output up to 10-12 A / 540-648 W	28701-BMR4550003 Rev C    November 2017
	© Flex

**Safety Specification****General information**

Flex Power Modules DC/DC converters and DC/DC regulators are designed in accordance with the safety standards IEC 60950-1, EN 60950-1 and UL 60950-1 *Safety of Information Technology Equipment*.

IEC/EN/UL 60950-1 contains requirements to prevent injury or damage due to the following hazards:

- Electrical shock
- Energy hazards
- Fire
- Mechanical and heat hazards
- Radiation hazards
- Chemical hazards

On-board DC/DC converters, Power interface modules and DC/DC regulators are defined as component power supplies. As components they cannot fully comply with the provisions of any safety requirements without "conditions of acceptability". Clearance between conductors and between conductive parts of the component power supply and conductors on the board in the final product must meet the applicable safety requirements. Certain conditions of acceptability apply for component power supplies with limited stand-off (see Mechanical Information and Safety Certificate for further information). It is the responsibility of the installer to ensure that the final product housing these components complies with the requirements of all applicable safety standards and regulations for the final product.

Component power supplies for general use should comply with the requirements in IEC/EN/UL 60950/1 *Safety of Information Technology Equipment*. Product related standards, e.g. IEEE 802.3af *Power over Ethernet*, and ETS-300132-2 *Power interface at the input to telecom equipment, operated by direct current (dc)* are based on IEC/EN/UL 60950-1 with regards to safety.

Flex Power Modules DC/DC converters, Power interface modules and DC/DC regulators are UL 60950-1 recognized and certified in accordance with EN 60950-1. The flammability rating for all construction parts of the products meet requirements for V-0 class material according to IEC 60695-11-10, *Fire hazard testing, test flames – 50 W* horizontal and vertical flame test methods.

**Isolated DC/DC converters & Power interface modules**

The product may provide basic or functional insulation between input and output according to IEC/EN/UL 60950-1 (see Safety Certificate), different conditions shall be met if the output of a basic or a functional insulated product shall be considered as safety extra low voltage (SELV).

For basic insulated products (see Safety Certificate) the output is considered as safety extra low voltage (SELV) if one of the following conditions is met:

- The input source provides supplementary or double or reinforced insulation from the AC mains according to IEC/EN/UL 60950-1.
- The input source provides functional or basic insulation from the AC mains and the product's output is reliably connected to protective earth according to IEC/EN/UL 60950-1.

For functional insulated products (see Safety Certificate) the output is considered as safety extra low voltage (SELV) if one of the following conditions is met:

- The input source provides double or reinforced insulation from the AC mains according to IEC/EN/UL 60950-1.
- The input source provides basic or supplementary insulation from the AC mains and the product's output is reliably connected to protective earth according to IEC/EN/UL 60950-1.
- The input source is reliably connected to protective earth and provides basic or supplementary insulation according to IEC/EN/UL 60950-1 and the maximum input source voltage is 60 Vdc.

Galvanic isolation between input and output is verified in an electric strength test and the isolation voltage ( $V_{iso}$ ) meets the voltage strength requirement for basic insulation according to IEC/EN/UL 60950-1.

It is recommended to use a slow blow fuse at the input of each product. If an input filter is used in the circuit the fuse should be placed in front of the input filter. In the rare event of a component problem that imposes a short circuit on the input source, this fuse will provide the following functions:

- Isolate the fault from the input power source so as not to affect the operation of other parts of the system
- Protect the distribution wiring from excessive current and power loss thus preventing hazardous overheating

Technical Specification

**PIM 4328 series** Power Interface Module  
 Input 36-75 V, Output up to 10-12 A / 540-648 W

28701-BMR4550003 Rev C November 2017  
 © Flex

**Absolute Maximum Ratings**

Characteristics			min	typ	max	Unit
T <sub>P1</sub>	Operating Temperature (see Thermal Consideration section)	P*	-40		+110	°C
		PD*	-40		+100	
T <sub>S</sub>	Storage temperature	P*	-55		+125	°C
		PD*	-40		+100	
V <sub>I</sub>	Input voltage				75	V
V <sub>I</sub>	Input voltage, reverse polarity				60	V
V <sub>I</sub>	Input voltage transient ANSI T1.315-2001 (R2006)				100	V
V <sub>I</sub>	Common mode surge pulses (1.2/50 μs) IEC 61000-4-5				500	V
V <sub>ISO</sub>	Isolation voltage, shelf ground to input, management power and alarm				2250	Vdc
	Isolation voltage, management power and alarm to shelf ground and input				2250	
V <sub>HU</sub>	Hold up capacitor voltage				100	V
C <sub>HU</sub>	Hold up capacitor capacitance				3300	μF

Stress in excess of Absolute Maximum Ratings may cause permanent damage. Absolute Maximum Ratings, sometimes referred to as no destruction limits, are normally tested with one parameter at a time exceeding the limits in the Electrical Specification. If exposed to stress above these limits, function and performance may degrade in an unspecified manner.

**Fundamental Circuit Diagram**

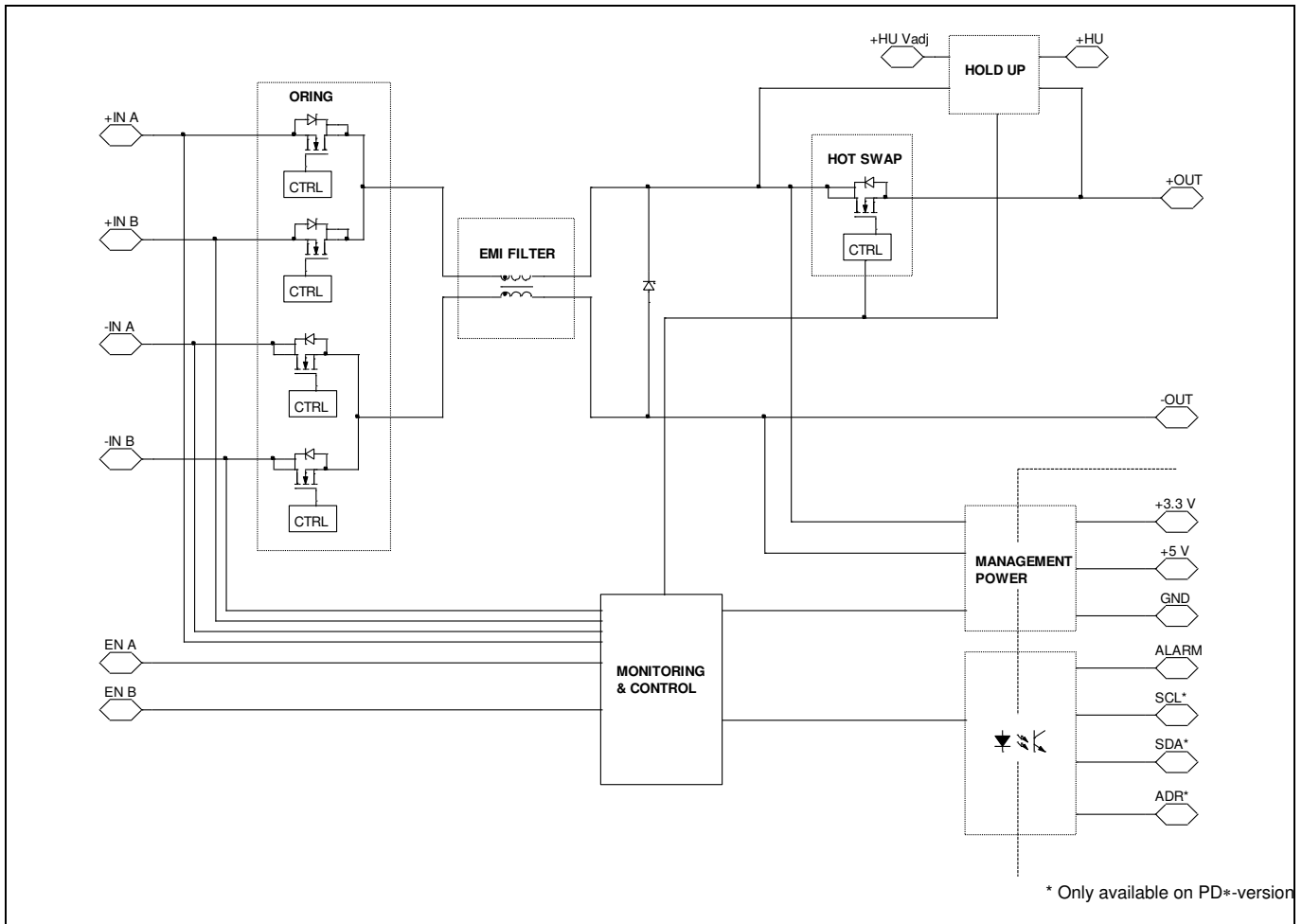

Technical Specification

<b>PIM 4328 series Power Interface Module</b> Input 36-75 V, Output up to 10-12 A / 540-648 W	28701-BMR4550003 Rev C    November 2017
	© Flex

**Main Unit (Output 1), 36-72 V, 10 A, Electrical Specification**

**PIM 4328**

$T_{P1} = -40$  to  $90$  °C,  $V_1 = 36$  to  $72$  V.

Typical values given at:  $T_{P1} = +25$  °C,  $V_1 = 53$  V,  $I_{O1} = 10$  A,  $I_{O2} = 3.6$  A and  $I_{O3} = 0.15$  A, unless otherwise specified under Conditions.

Characteristics		Conditions	min	typ	max	Unit
$V_I$	Input voltage range		36	53	72	V
$V_{EN\ A/B\ off}$	Enable turn-off threshold voltage	Decreasing feed A and B voltage	32	33		V
$V_{EN\ A/B\ on}$	Enable turn-on threshold voltage	Increasing feed A or B voltage		35	36	V
$C_I$	Internal input capacitance			13		µF
$\eta$	Efficiency	$P_{O1} = 200$ W, $I_{O2} = 0$ A, $I_{O3} = 0$ A	P*	99.1		%
			PD*	98.6		
		$P_{O1} = 300$ W, $I_{O2} = 0$ A, $I_{O3} = 0$ A	P*	99.1		
			PD*	98.8		
		$I_{O1} = 10$ A, $I_{O2} = 0$ A, $I_{O3} = 0$ A	P*	98.7		
			PD*	98.7		
		$I_{O1} = 10$ A, $I_{O2} = 3.6$ A, $I_{O3} = 0.15$ A	P*	98.2		
			PD*	98.1		
$P_d$	Power Dissipation	$I_{O1} = 10$ A, $I_{O2} = 3.6$ A, $I_{O3} = 0.15$ A	P*	10	14	W
			PD*	11	15	
$P_{ii}$	Input idling power	$V_1 = 53$ V, $I_{O1} = I_{O2} = I_{O3} = 0$ A	P*	1		W
			PD*	1.9		
$P_{UVLO}$	Input standby power	$V_1 <$ Enable turn off input voltage	P*	0.4		W
			PD*	0.6		

$t_r$	Ramp-up time (from 10-90 % of $V_{O1}$ )	Typical specification at: $V_1 = 53$ V, $I_{O1} = I_{O2} = I_{O3} = 0$ A, $C_{O1} = 220$ µF		1.4		ms	
$t_s$	Start-up time (from $V_1$ connection to 90 % of $V_{O1}$ )		P*	3.4	500		ms
		PD*	160	650			
$I_{O1}$	Output current	see Note 1	0	10		A	
		see Notes 1 and 2	PD*	0	12		
$I_{lim}$	Current limit threshold	$T_{P1} <$ max $T_{P1}$	P*	12.5	13.5	14.5	A
			PD*	13.5	14.5	15.5	
$I_{sc}$	Short circuit current	$T_{P1} = 25$ °C, see Note 3		0.5		A	
$C_{O1}$	Recommended Capacitive Load	$T_{P1} = 25$ °C, see Note 4	100	470		µF	
$I_{PK}$	Inrush current transient	0.1-0.9 ms		40		A	
		0.9-3.0 ms		40-18			

Note 1: No load allowed at start-up, see Hot Swap Functionality section

Note 2: See Increased output 1 maximum current 12 A section

Note 3: RMS current, hiccup mode over current protection

Note 4: See Hold Up Event Voltage section

## Technical Specification

**PIM 4328 series** Power Interface Module  
Input 36-75 V, Output up to 10-12 A / 540-648 W

28701-BMR4550003 Rev C November 2017

© Flex

**Hold up, Electrical Specification****PIM 4328** $T_{P1} = -40$  to  $90$  °C,  $V_I = 36$  to  $72$  V.Typical values given at:  $T_{P1} = +25$  °C,  $V_I = 53$  V,  $I_{O1} = 10$  A,  $I_{O2} = 3.6$  A and  $I_{O3} = 0.15$  A, unless otherwise specified under Conditions.

Characteristics		Conditions	min	typ	max	Unit
$C_{HU}$	Hold up capacitance	See Hold Up Safe Operating Area	Note 5		3300	μF
$f_{HU}$	Hold up generator switching frequency			500		kHz
$V_{HU}$	Hold up capacitor voltage adjust range		40		95	V
$t_{HU}$	Hold up time, see Note 6	$C_{HU} = 1200$ μF, $P_O = 300$ W, $V_{HU} = 75$ V		8.7		ms
$V_{TH}$	Hold up event threshold voltage			36.8		V
$V_{HUOVP}$	Hold up over voltage protection			95		V

Note 5: Ensure minimum 2ms hold up time at 300W or 3.5 ms hold up time at 390W to maintain operation during input voltage transient (ANSI T1.315-2001 (R2006))

Note 6: Time elapsed between output 1 reaches the hold up threshold voltage prior to and after the hold up event

**Alarm, Electrical Specification** $T_{P1} = -40$  to  $90$  °C,  $V_I = 36$  to  $72$  V.Typical values given at:  $T_{P1} = +25$  °C,  $I_{O1} = 10$  A,  $I_{O2} = 3.6$  A and  $I_{O3} = 0.15$  A, unless otherwise specified under Conditions.

Characteristics		Conditions	min	typ	max	Unit
$V_I$	Alarm threshold	Normal conditions, increasing feed A and B voltages		38.6		V
		Fault conditions, decreasing feed A or B voltages		36.9		
$I_{ALARM}$	Alarm sink current	Normal conditions, feed A and B voltages above alarm threshold			135	mA
$V_{ALARM}$	Alarm open drain voltage	Fault conditions, feed A or B voltage below alarm threshold			90	V

Technical Specification

<b>PIM 4328 series Power Interface Module</b> Input 36-75 V, Output up to 10-12 A / 540-648 W	28701-BMR4550003 Rev C    November 2017
	© Flex

**Management Power (Output 2 and 3), 3.3 V, 3.6 A / 5.0 V, 0.15 A Electrical Specification** **PIM 4328**

$T_{P1} = -40$  to  $90$  °C,  $V_1 = 36$  to  $72$  V, unless otherwise specified under Conditions.  
 Typical values given at:  $T_{P1} = +25$  °C,  $V_1 = 53$  V,  $I_{O1} = 10$  A,  $I_{O2} = 3.6$  A and  $I_{O3} = 0.15$  A, unless otherwise specified under Conditions.

Characteristics		Conditions	min	typ	max	Unit	
$V_{EN\ A/B\ off}$	Enable turn-off threshold voltage	Decreasing feed A and B voltage	32	33		V	
$V_{EN\ A/B\ on}$	Enable turn-on threshold voltage	Increasing feed A or B voltage		35	36	V	
$\eta$	Efficiency	$I_{O1} = 0$ A, $I_{O2} = 3.6$ A, $I_{O3} = 0.15$ A, see Note 7	P*		74.8	%	
			PD*		71.8		
$P_d$	Power Dissipation		P*		4	6	W
			PD*		5	7	

		Output 2			Output 3								
		min	typ	max	min	typ	max						
$V_{O1}$	Output voltage initial setting and accuracy	$T_{P1} = +25$ °C, $V_1 = 53$ V, $I_{O2} = 1.8$ A, $I_{O3} = 0.075$ A			3.3			5.0	V				
$V_O$	Output voltage tolerance band	P*: 10-100 % of max $I_{O2}$ PD*: 0-100 % of max $I_{O2}$			3.2			3.4	V				
		0-100 % of max $I_{O3}$						4.75		5.25			
	Idling voltage	$I_{O2} = I_{O3} = 0$ A	P*		4	4.3	5.1		5.25	V			
			PD*		3.25	3.32	3.40	4.90	5.00		5.10		
	Line regulation	$I_{O2} = 3.6$ A, $I_{O3} = 0.15$ A	P*		50			3		mV			
PD*			2										
Load regulation	$V_1 = 53$ V, $I_{O3} = 0.15$ A, P*: $I_{O2} = 10$ -100% of max $I_{O2}$ PD*: $I_{O2} = 0$ -100% of max $I_{O2}$				30			mV					
		$V_1 = 53$ V, $I_{O2} = 3.6$ A, $I_{O3} = 10$ -100 % of max $I_{O3}$			10								
$V_{tr}$	Load transient voltage deviation	$V_1 = 53$ V, Load step $I_{O2} = 25$ -75-25 % of max $I_{O2}$ , $I_{O3} = 0.15$ A, $C_{O2} = 360$ µF, $di/dt = 1$ A/µs			±200			±40	mV				
$t_{tr}$	Load transient recovery time				200			0	µs				
$t_r$	Ramp-up time (from 10-90 % of $V_{O1}$ )	$I_{O2} = I_{O3} = 10$ -100 % of max $I_O$			2			1	ms				
$t_s$	Start-up time (from $V_1$ connection to 90 % of $V_{O1}$ )	P*		4			3		ms				
		PD*		60			60						
$I_O$	Output current	P*		0.36		3.6			0	0.15	A		
		PD*		0		3.6							
$I_{lim}$	Current limit threshold	$T_{P1} < \max T_{P1}$			4.5		5.5		0.2	0.5	A		
$I_{sc}$	Short circuit current	$T_{P1} = 25$ °C			5.7		0.08			A			
$C_{O1}$	Recommended Capacitive Load	P*		0		10			0		10		mF
		PD*		0		1			0		1		
$V_{Oac}$	Output ripple & noise	See ripple & noise section, max $I_O$			30			20		mV <sub>p-p</sub>			
$f_s$	Switching frequency	$I_{O2} = I_{O3} = 10$ -100 % of max $I_O$			510			1500			kHz		
$V_{OVP}$	Output overvoltage protection	$I_{O2} = I_{O3} = 0$ A		PD*		4.0		N/A			V		

Note 7: Idling losses in main unit is included

## Technical Specification

**PIM 4328 series** Power Interface Module  
Input 36-75 V, Output up to 10-12 A / 540-648 W

28701-BMR4550003 Rev C November 2017

© Flex

## Functional Description

## PIM 4328 PD\*

$T_{P1} = -40$  to  $90$  °C,  $V_I = 36$  to  $72$  V.

Typical values given at:  $T_{P1} = +25$  °C,  $V_I = 53$  V,  $I_{O1} = 10$  A,  $I_{O2} = 3.6$  A and  $I_{O3} = 0.15$  A, unless otherwise specified under Conditions.

Characteristics		Comments	min	typ	max	Unit
<b>PMBus monitoring accuracy</b>						
READ_VIN	ORed input voltage	Converted from PMBus format	-1	±0.5	1	% of full scale
MFR_READ_VINA	Feed A input voltage					
MFR_READ_VINB	Feed B input voltage	Scale	0		112.5	V
READ_VCAP	Hold up capacitor voltage	Converted from PMBus format	-1	±0.5	1	% of full scale
		Scale	0		115	V
READ_IOUT	Output current	Converted from PMBus format	-3	±0.5	3	% of full scale
		Scale	0		16.5	A
READ_TEMPERATURE_1	P1 temperature	Converted from PMBus format, $T_{P1} = 25$ to $90$ °C	-5	±3	5	°C
<b>Fault Protection Characteristics</b>						
UVLO, input under voltage lockout	Delay			10	40	ms
OCP, over current protection	Fault response time			1.5		ms
OTP, over temperature protection	Trip limit			120		°C
	Hysteresis			10		°C
	Fault response time				1	s

Command		Read	Format
<b>Registers</b>			
MFR_STATUS_BITS	Status register	Read byte	bit field
<b>Status command</b>			
STATUS_BYTE	Only CML bit used (communication fault only)	Read word PMBus spec. 1.2 17.1	Initial state: 00h bit field
<b>PMBus revision</b>			
PMBUS_REVISION	PMBus revision	Read byte PMBus spec. 1.2 22.1	Example: 1.2 bit field



Technical Specification

**PIM 4328 series** Power Interface Module  
 Input 36-75 V, Output up to 10-12 A / 540-648 W

28701-BMR4550003 Rev C November 2017  
 © Flex

**Functional Description (Continued)**

**PIM 4328 PD\***

$T_{P1} = -40$  to  $90$  °C,  $V_I = 36$  to  $72$  V.

Typical values given at:  $T_{P1} = +25$  °C,  $V_I = 53$  V,  $I_{O1} = 10$  A,  $I_{O2} = 3.6$  A and  $I_{O3} = 0.15$  A, unless otherwise specified under Conditions.

Characteristics		Comments	Read	Unit
<b>Manufacturer's information</b>				
MFR_ID	Manufacturer's ID	Read block, format: 8 byte	ERICSSON	ASCII
MFR_MODEL	Manufacturer's type designation	Read block, format: 12 byte	Example: PIM4328PD See Note 8	ASCII
MFR_REVISION	Product's revision	Read block, format: 3 byte	Example: R1A	ASCII
MFR_DATE	Date of manufacture	Read block, format: YYMMDD	Example: 120425	ASCII
MFR_SERIAL	Serial number	Read block, format: 13 byte	Example: X100160020182	ASCII

Logic Input/Output Characteristics		min	typ	max	Unit
<b>Logic Input/Output Characteristics</b>					
PMBus frequency		10		400	kHz
Logic input low ( $V_{IL}$ )	SCL, SDA			0.96	V
Logic input high ( $V_{IH}$ )		2.38			
Logic output low ( $V_{OL}$ )				0.4	
Logic output high ( $V_{OH}$ )		3.16			
Setup time, SMBus		460			ns
Hold time, SMBus		210			
Bus free time ( $T_{BUF}$ )	Note 9	After read access	1.3		$\mu$ s
		After write access	30		

Note 8: Alternative designation BMR 455 0+03/\*\* may also occur

Note 9: It is recommended that a PMBus master reads back written data for verification i.e. do not rely on the ACK/NACK bit since this bit are as susceptible to errors as any other bit. However, under very rare operating conditions, it is possible to get intermittent read back failures. It is therefore recommended to implement error handling in the master that also deals with those situations.

**Main Unit (Output 1), 36-72 V, 10 A, Typical Characteristics**

**PIM 4328**

**Efficiency (P\*)**

**Efficiency (PD\*)**

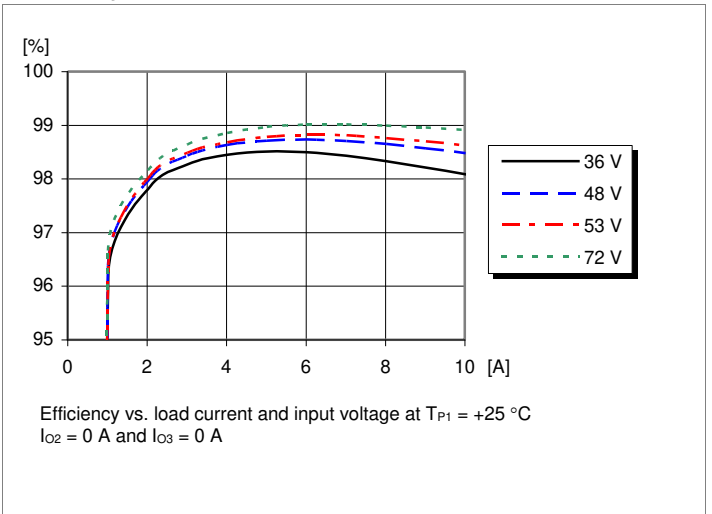
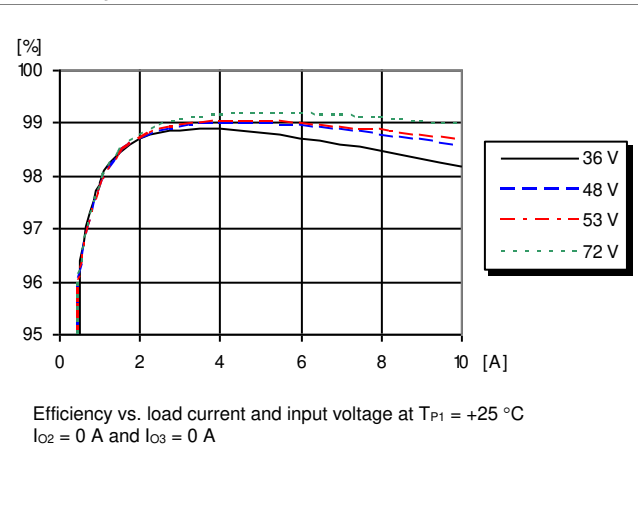

**PIM 4328 series** Power Interface Module  
 Input 36-75 V, Output up to 10-12 A / 540-648 W

28701-BMR4550003 Rev C November 2017  
 © Flex

**Main Unit (Output 1), 36-72 V, 10 A, Typical Characteristics**

**PIM 4328**

**Power Dissipation (P\*)**

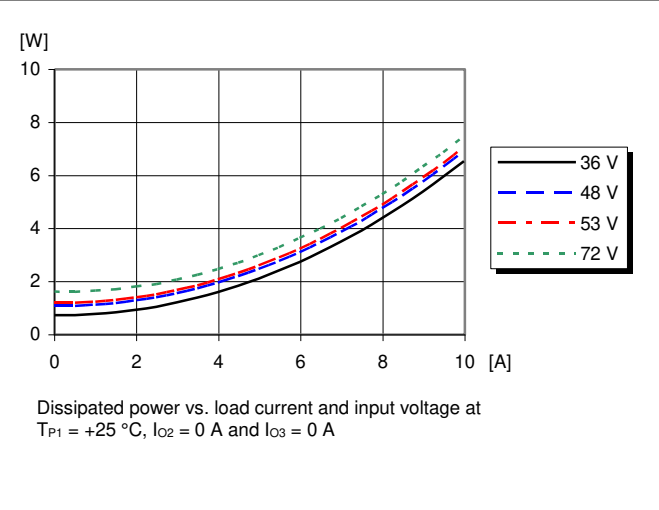

**Power Dissipation (PD\*)**

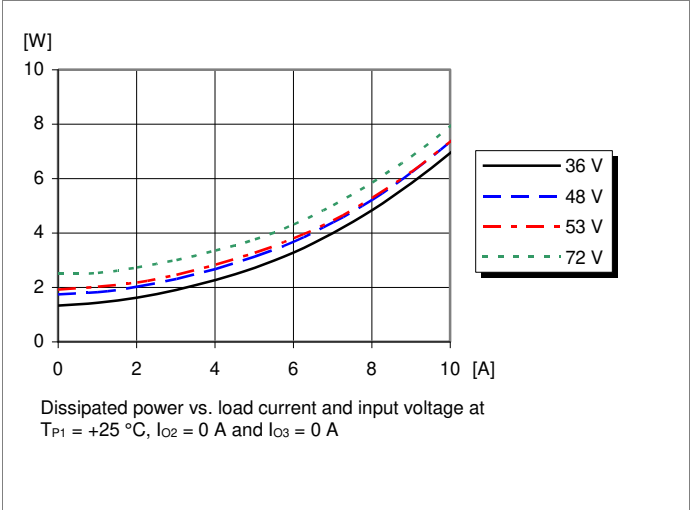

**Output Current Derating, Functional Insulation (P\*)**

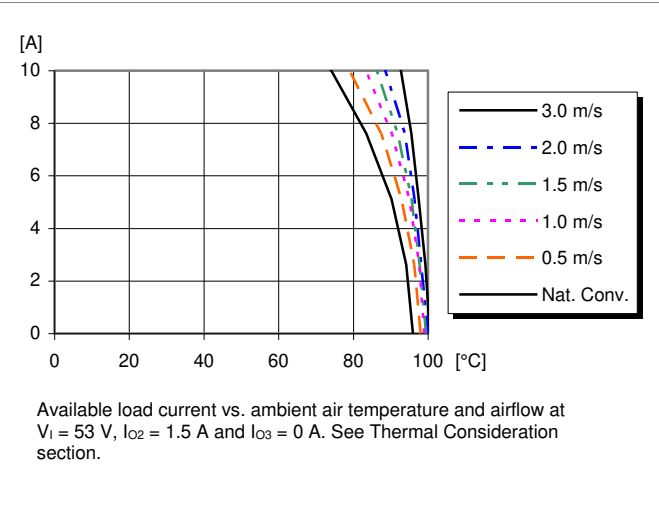

**Output Current Derating, Functional Insulation (PD\*)**

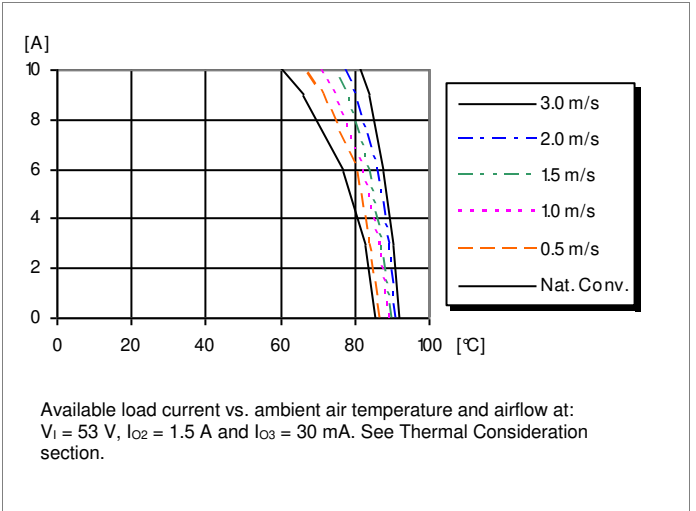

**Output Current Derating, Basic Insulation (P\*)**

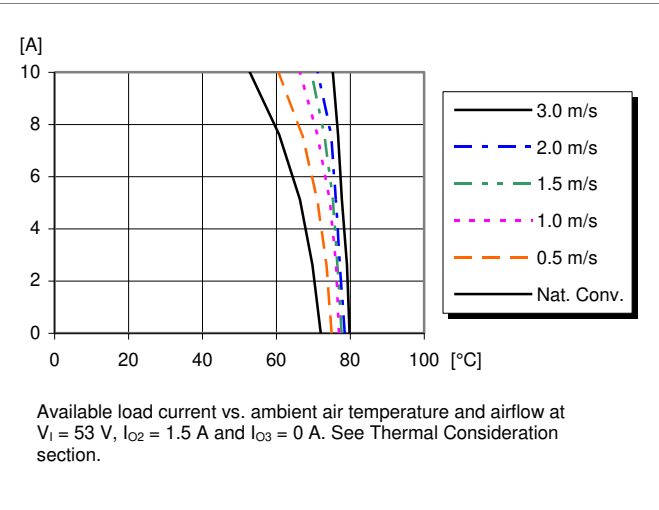

**Output Current Derating, Basic Insulation (PD\*)**

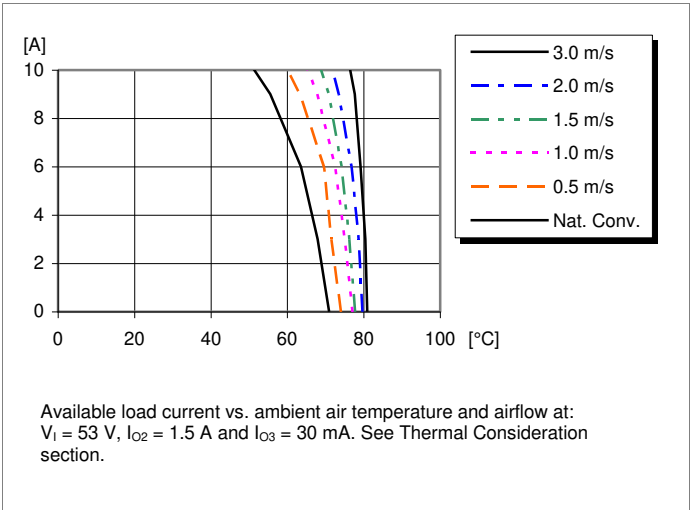

**PIM 4328 series** Power Interface Module  
 Input 36-75 V, Output up to 10-12 A / 540-648 W

28701-BMR4550003 Rev C November 2017  
 © Flex

**Main Unit (Output 1), 36-72 V, 10 A, Typical Characteristics**

**PIM 4328**

**Start-up**

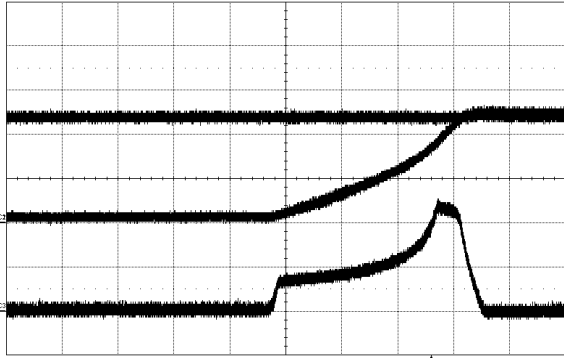

Start-up enabled by connecting  $V_1$  at:  
 $T_{P1} = +25\text{ }^\circ\text{C}$ ,  $V_1 = 53\text{ V}$ , no load,  
 output capacitance = 220  $\mu\text{F}$

Top trace: input voltage (10 V/div.).  
 Second trace: output 1 voltage (10 V/div.).  
 Bottom trace: input current (5 A/div.).  
 Time scale: (1 ms/div.).

**Hold up performance**

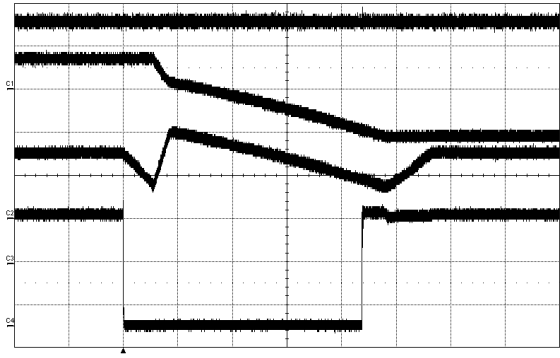

Output voltage at loss of input power at:  
 hold up capacitance =  $3 \times 470\text{ }\mu\text{F}$ ,  
 hold up voltage = 75 V,  $T_{P1} = +25\text{ }^\circ\text{C}$ ,  
 $I_{O1} = 6.5\text{ A}$  (300 W DC/DC converter),  $I_{O2} = 3\text{ A}$ ,  $I_{O3} = 0\text{ A}$

Top trace: output 2 voltage (2 V/div.).  
 Second trace: Hold up voltage (20 V/div.).  
 Third trace: output 1 voltage (20 V/div.).  
 Bottom trace: input voltage (20 V/div.).  
 Time scale: (2 ms/div.).

**ORing**

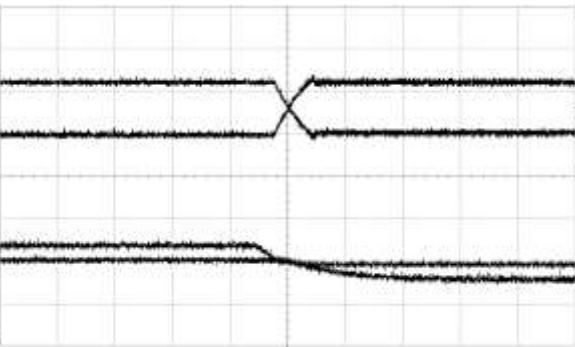

ORing at:  
 $T_{P1} = +25\text{ }^\circ\text{C}$ ,  $V_{IA} = 54\text{-}52\text{ V}$ ,  
 $V_{IB} = 53\text{ V}$ ,  
 $I_{O1} = 6\text{ A}$  electronic load,  
 $I_{O2} = 0\text{ A}$ ,  $I_{O3} = 0\text{ A}$ .

Top trace: input A current (5 A/div.).  
 Second trace: input B current (5 A/div.).  
 Third trace: input A voltage (2 V/div.).  
 Bottom trace: input B voltage (2 V/div.).  
 Time scale: (0.1 s/div.).

**ORing functionality with one feed shorted**

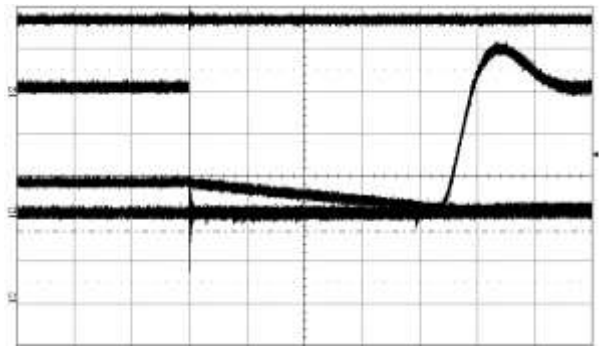

ORing functionality at:  
 $T_{P1} = +25\text{ }^\circ\text{C}$ ,  $V_{IA} = 53\text{ V}$ ,  $V_{IB} = 45\text{ V}$ ,  
 $I_{O1} = 5.6\text{ A}$ ,  $I_{O2} = 0\text{ A}$ ,  $I_{O3} = 0\text{ A}$ .

Top trace: output 2 voltage (2 V/div.).  
 Second trace: input B current (2 A/div.).  
 Third trace: output 1 voltage (20 V/div.).  
 Bottom trace: input A current (2 A/div.).  
 Time scale: (0.1 ms/div.).

**Start-up sequence (P\*)**

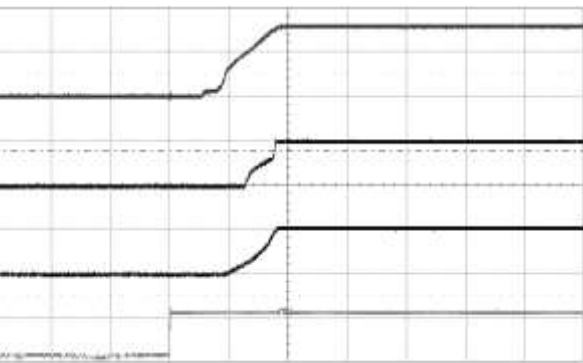

Start-up sequence at:  
 $T_{P1} = +25\text{ }^\circ\text{C}$ ,  $V_{IA} = 53\text{ V}$   
 $I_{O1} = 0\text{ A}$ ,  $I_{O2} = 3.6\text{ A}$ ,  
 $I_{O3} = 0.15\text{ A}$ .

Top trace: output 2 voltage (2V/div)  
 Second trace: output 3 voltage (5V/div)  
 Third trace: output 1 voltage (50V/div)  
 Bottom trace: input A voltage (50V/div)  
 Time scale: (2 ms/div.).

**Start-up sequence (PD\*)**

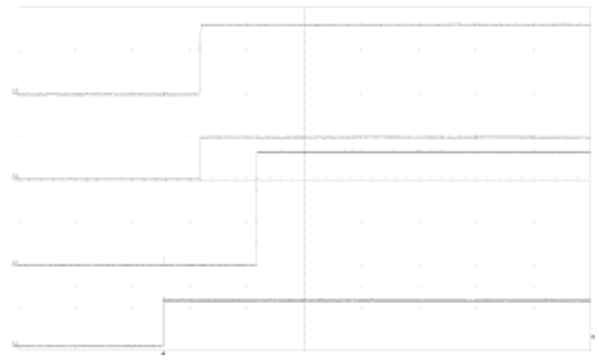

Start-up sequence at:  
 $T_{P1} = +25\text{ }^\circ\text{C}$ ,  $V_{IA} = 53\text{ V}$   
 $I_{O1} = 0\text{ A}$ ,  $I_{O2} = 3.6\text{ A}$ ,  $I_{O3} = 0.15\text{ A}$ .

Top trace: output 2 voltage (2V/div)  
 Second trace: output 3 voltage (5V/div)  
 Third trace: output 1 voltage (20V/div)  
 Bottom trace: input A voltage (50V/div)  
 Time scale: (100 ms/div.).

Technical Specification

**PIM 4328 series** Power Interface Module  
 Input 36-75 V, Output up to 10-12 A / 540-648 W

28701-BMR4550003 Rev C November 2017  
 © Flex

**Management Power (Output 2 and 3), 3.3 V, 3.6 A / 5 V, 0.15 A, Typical Characteristics**

**PIM 4328 P\***

**Output 2 Characteristics (P\*)**

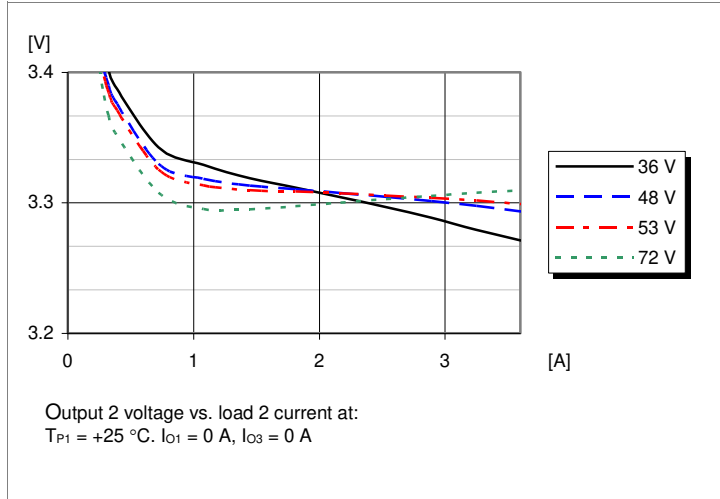

**Output 3 Characteristics (P\*)**

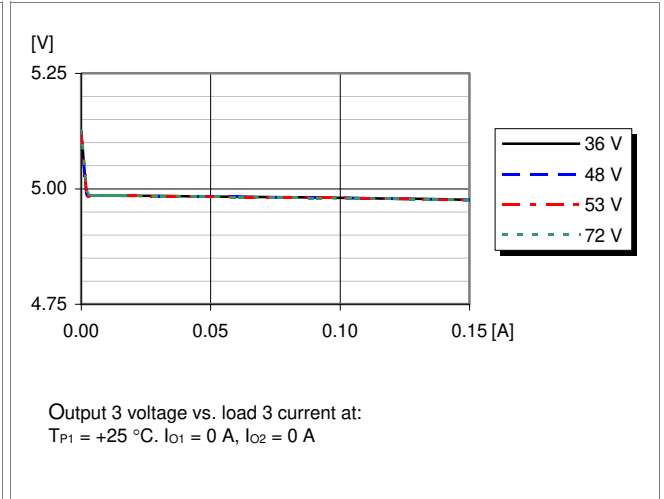

**Output 2 Current Limit Characteristic (P\*)**

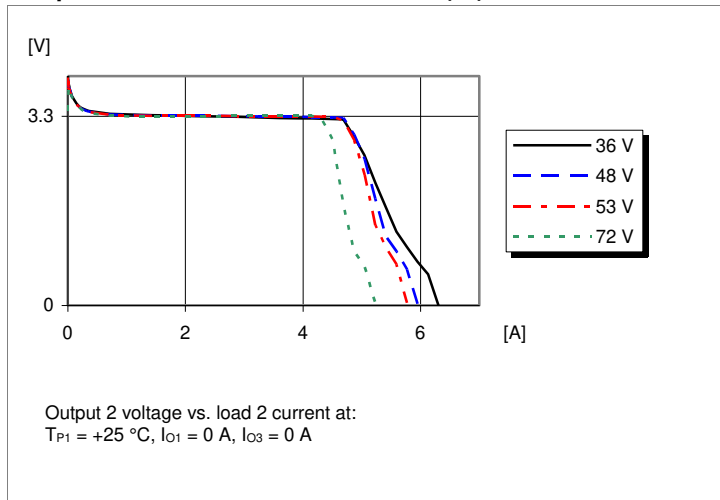

**Output 3 Current Limit Characteristic (P\*)**

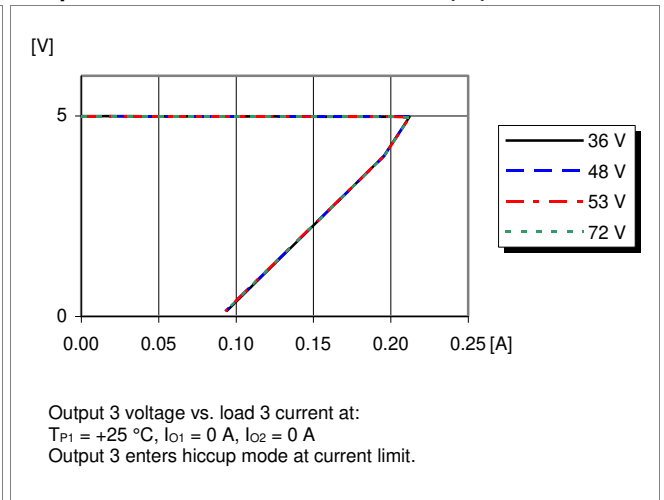

**Power Dissipation (P\*)**

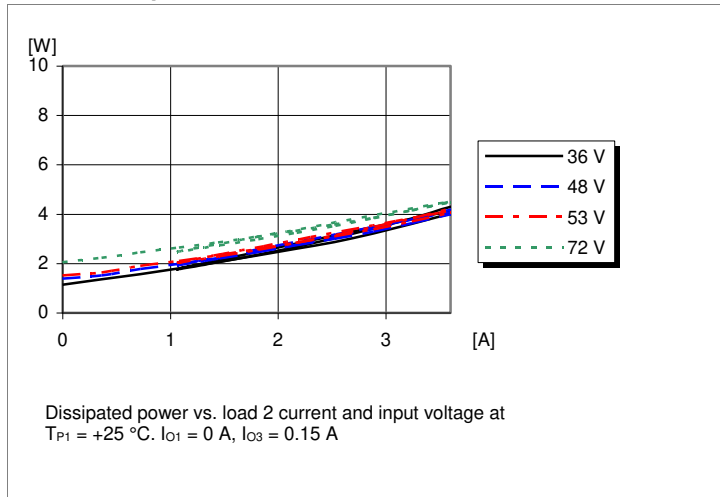

**Output Current Derating, Functional Insulation (P\*)**

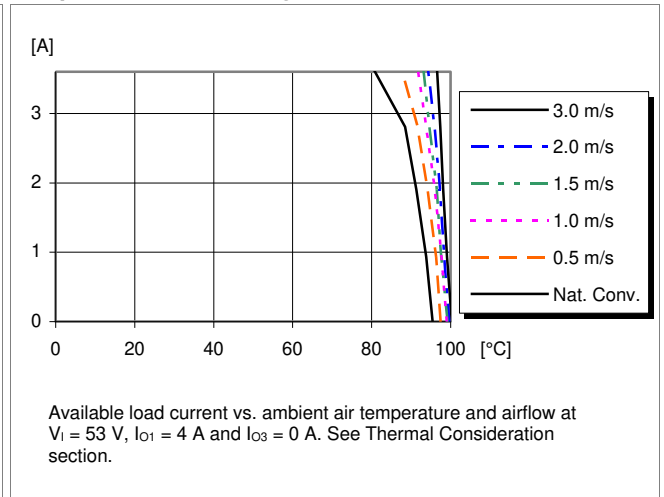

Technical Specification

**PIM 4328 series Power Interface Module**  
 Input 36-75 V, Output up to 10-12 A / 540-648 W

28701-BMR4550003 Rev C November 2017  
 © Flex

**Management Power (Output 2 and 3), 3.3 V, 3.6 A / 5 V, 0.15 A, Typical Characteristics**

**PIM 4328 P\***

**Output Current Derating, Basic Insulation (P\*)**

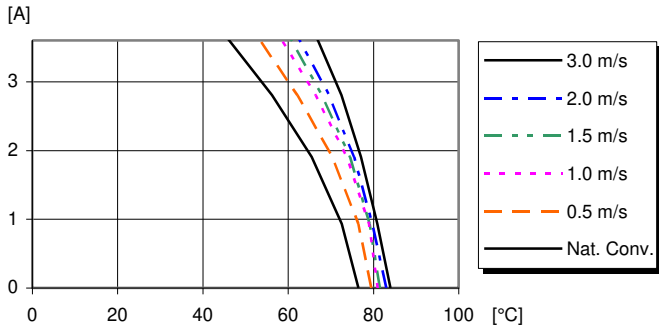

Available load current vs. ambient air temperature and airflow at  $V_i = 53\text{ V}$ ,  $I_{o1} = 4\text{ A}$  and  $I_{o3} = 0\text{ A}$ . See Thermal Consideration section.

**Start-up (P\*)**

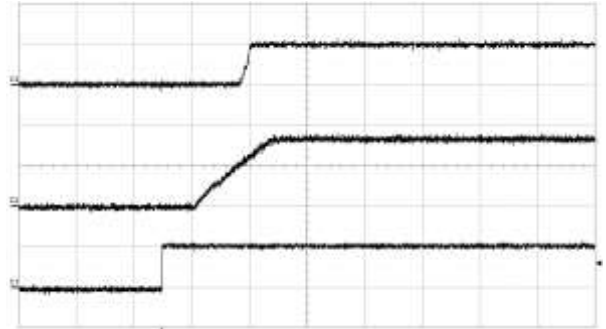

Start-up enabled by connecting  $V_i$  at:  $T_{P1} = +25\text{ °C}$ ,  $V_i = 53\text{ V}$ ,  $I_{o1} = 0\text{ A}$ ,  $I_{o2} = 3.6\text{ A}$ ,  $I_{o3} = 0.15\text{ A}$ , resistive loads.

Top trace: output 3 voltage (5 V/div.).  
 Mid trace: output 2 voltage (2 V/div.).  
 Bottom trace: input voltage (50 V/div.).  
 Time scale: (2 ms/div.).

**Shut-down (P\*)**

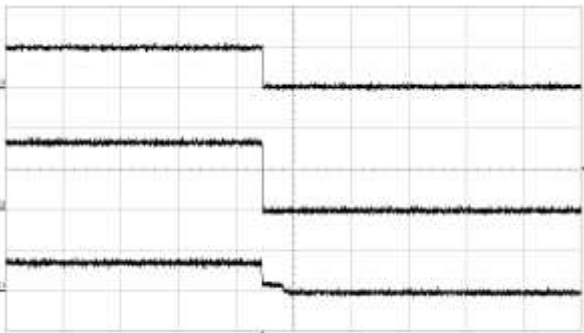

Shut-down enabled by disconnecting  $V_i$  at:  $T_{P1} = +25\text{ °C}$ ,  $V_i = 53\text{ V}$ ,  $I_{o1} = 0\text{ A}$ ,  $I_{o2} = 3.6\text{ A}$ ,  $I_{o3} = 0.15\text{ A}$ , resistive loads.

Top trace: output 3 voltage (5 V/div.).  
 Mid trace: output 2 voltage (2 V/div.).  
 Bottom trace: input voltage (50 V/div.).  
 Time scale: (20 ms/div.).

**Output 2 Ripple & Noise (P\*)**

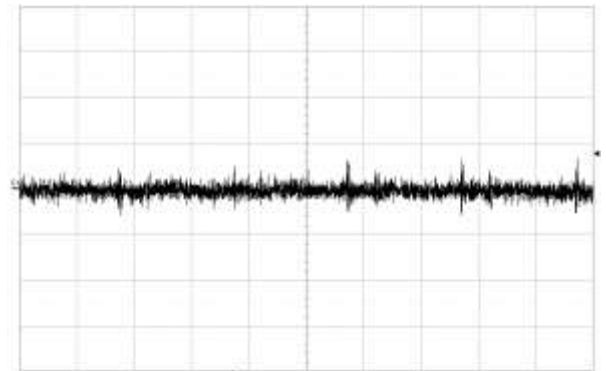

Output voltage ripple at:  $T_{P1} = +25\text{ °C}$ ,  $V_i = 53\text{ V}$ ,  $I_{o1} = 0\text{ A}$ ,  $I_{o2} = 3.6\text{ A}$ ,  $I_{o3} = 0.15\text{ A}$ , resistive loads.

Output 2 voltage (20 mV/div.).  
 Time scale: (1  $\mu\text{s}$ /div.).

**Output 3 Ripple & Noise (P\*)**

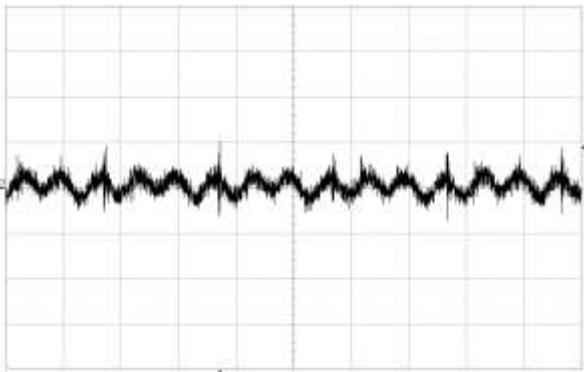

Output voltage ripple at:  $T_{P1} = +25\text{ °C}$ ,  $V_i = 53\text{ V}$ ,  $I_{o1} = 0\text{ A}$ ,  $I_{o2} = 3.6\text{ A}$ ,  $I_{o3} = 0.15\text{ A}$ , resistive loads.

Output 3 voltage (20 mV/div.).  
 Time scale: (1  $\mu\text{s}$ /div.).

**Output Load Transient Response (P\*)**

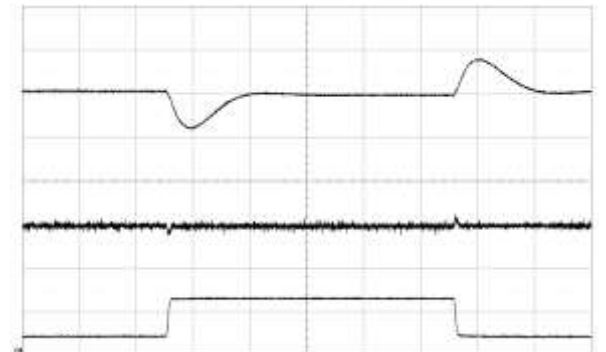

Output voltage response to load current step-change, output 2 (0.9-2.7-0.9 A) at:  $T_{P1} = +25\text{ °C}$ ,  $V_i = 53\text{ V}$ ,  $I_{o1} = 0\text{ A}$ ,  $I_{o3} = 0.15\text{ A}$ , resistive load,  $C_{O2} = 360\text{ }\mu\text{F}$

Top trace: output 2 voltage (0.2 V/div.).  
 Mid trace: output 3 voltage (0.2 V/div.).  
 Bottom trace: output 2 current (2 A/div.).  
 Time scale: (0.2 ms/div.).

Technical Specification

**PIM 4328 series** Power Interface Module  
 Input 36-75 V, Output up to 10-12 A / 540-648 W

28701-BMR4550003 Rev C November 2017  
 © Flex

**Management Power (Output 2 and 3), 3.3 V, 3.6 A / 5 V, 0.15 A, Typical Characteristics**

**PIM 4328 PD\***

**Output 2 Characteristics (PD\*)**

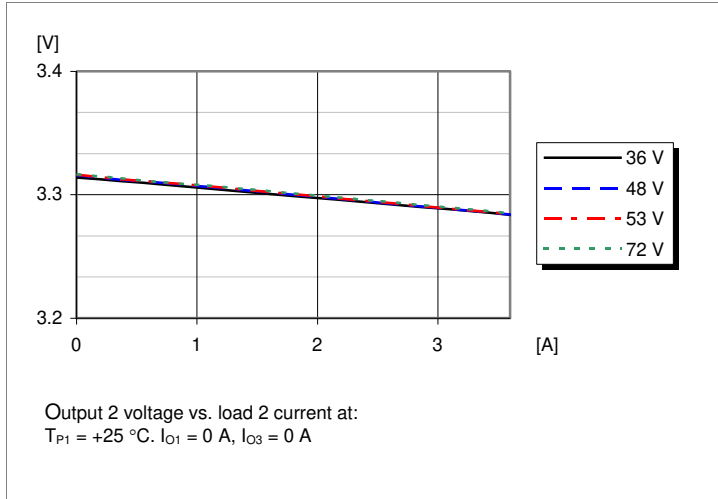

**Output 3 Characteristics (PD\*)**

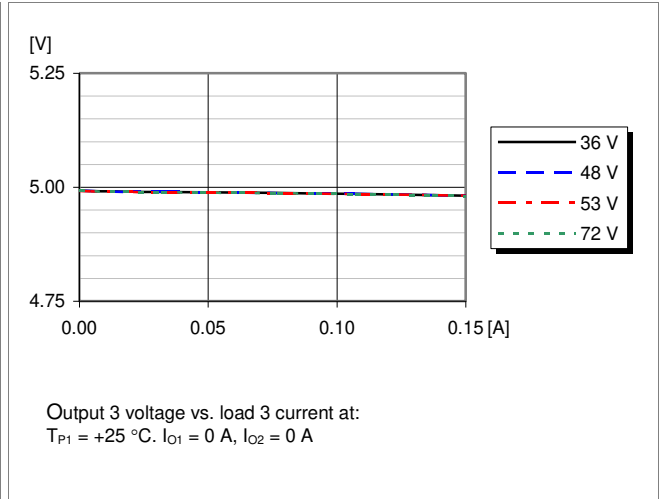

**Output 2 Current Limit Characteristic (PD\*)**

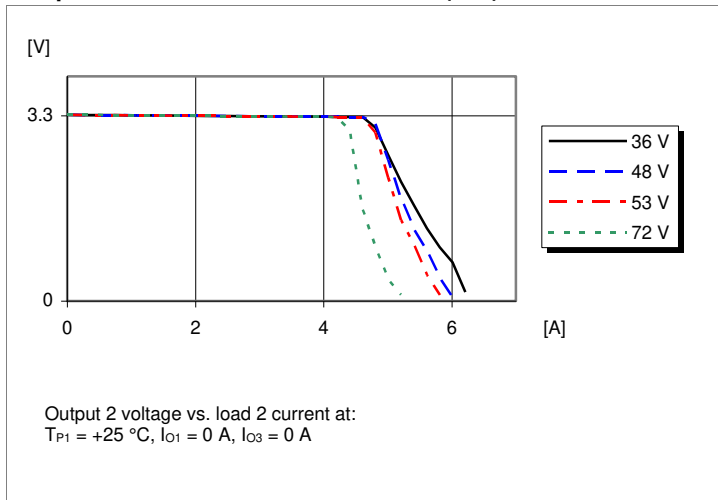

**Output 3 Current Limit Characteristic (PD\*)**

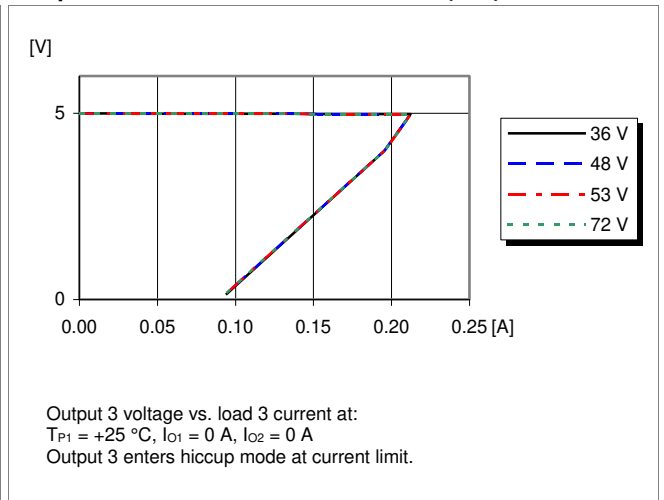

**Power Dissipation (PD\*)**

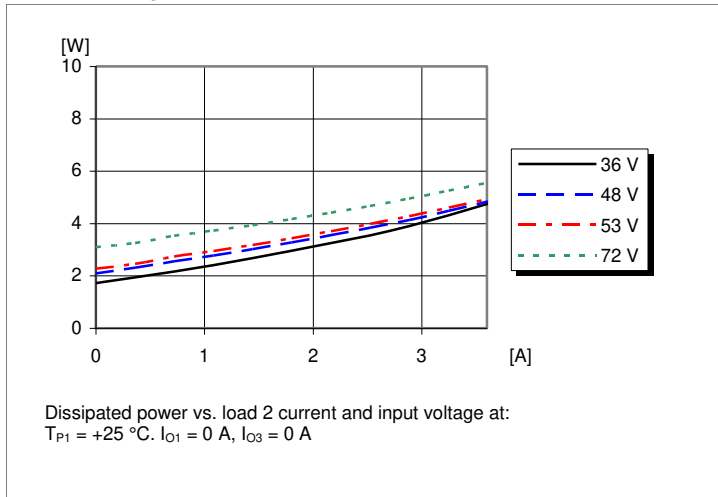

**Output Current Derating, Functional Insulation (PD\*)**

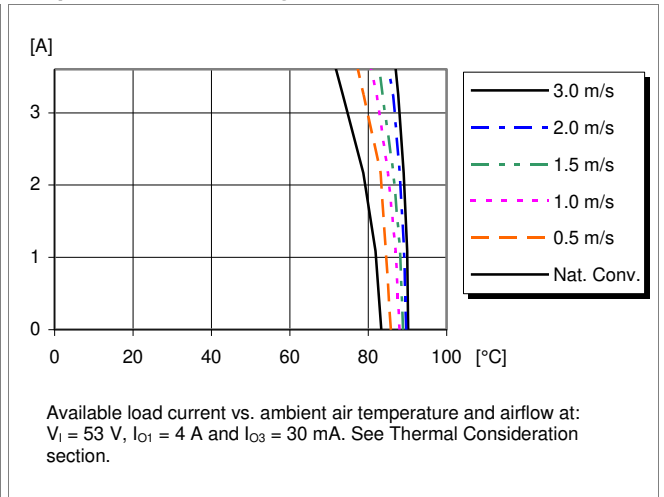

**PIM 4328 series Power Interface Module**  
 Input 36-75 V, Output up to 10-12 A / 540-648 W

28701-BMR4550003 Rev C November 2017

© Flex

**Management Power (Output 2 and 3), 3.3 V, 3.6 A / 5 V, 0.15 A, Typical Characteristics**

**PIM 4328 PD\***

**Output Current Derating, Basic Insulation (PD\*)**

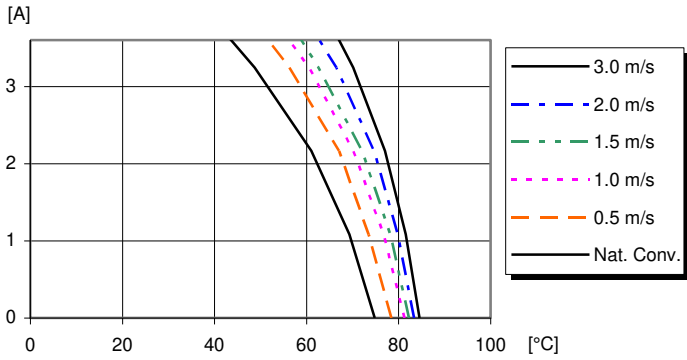

Available load current vs. ambient air temperature and airflow at:  
 $V_i = 53\text{ V}$ ,  $I_{O1} = 4\text{ A}$  and  $I_{O3} = 30\text{ mA}$ . See Thermal Consideration section.

**Start-up (PD\*)**

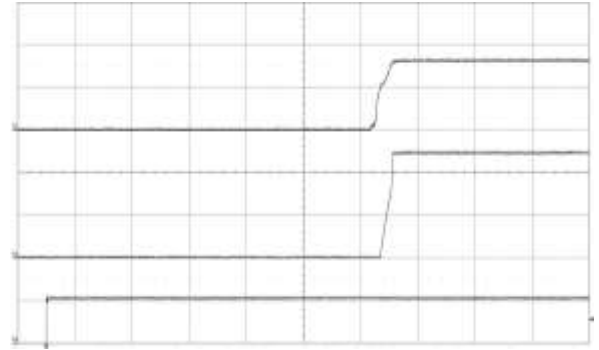

Start-up enabled by connecting  $V_i$  at:  $T_{P1} = +25\text{ °C}$ ,  $V_i = 53\text{ V}$ ,  $I_{O1} = 0\text{ A}$ ,  $I_{O2} = 3.6\text{ A}$ ,  $I_{O3} = 0.15\text{ A}$ , resistive loads.

Top trace: output 2 voltage (2 V/div.).  
 Second trace: output 3 voltage (2 V/div.).  
 Bottom trace: input voltage (50 V/div.).  
 Time scale: (10 ms/div.).

**Shut-down (PD\*)**

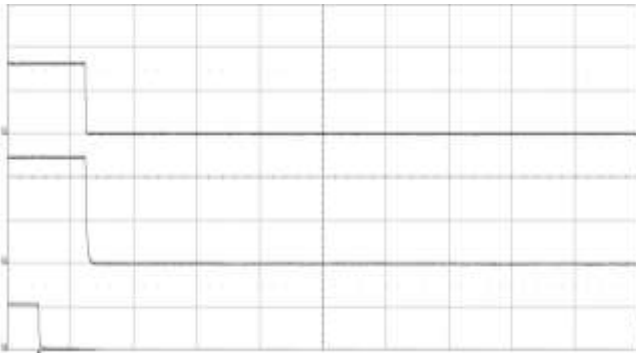

Shut-down enabled by disconnecting  $V_i$  at:  $T_{P1} = +25\text{ °C}$ ,  $V_i = 53\text{ V}$ ,  $I_{O1} = 0\text{ A}$ ,  $I_{O2} = 3.6\text{ A}$ ,  $I_{O3} = 0.15\text{ A}$ , resistive loads.

Top trace: output 2 voltage (2 V/div.).  
 Second trace: output 3 voltage (2 V/div.).  
 Bottom trace: input voltage (50 V/div.).  
 Time scale: (20 ms/div.).

**Output 2 and 3 Ripple & Noise (PD\*)**

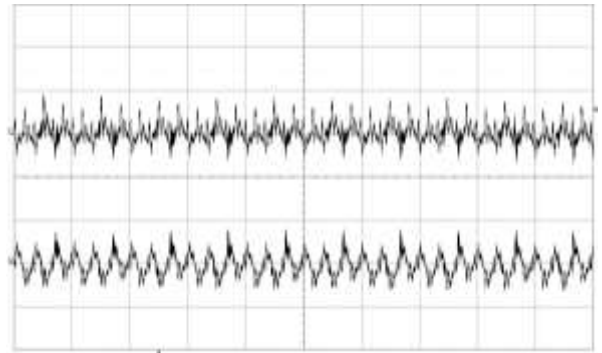

Output voltage ripple at:  $T_{P1} = +25\text{ °C}$ ,  $V_i = 53\text{ V}$ ,  $I_{O1} = 0\text{ A}$ ,  $I_{O2} = 3.6\text{ A}$ ,  $I_{O3} = 0.15\text{ A}$ , resistive loads.

Top trace: output 2 voltage (10 mV/div.).  
 Bottom trace: output 3 voltage (10mV/div.).  
 Time scale: (2  $\mu$ s/div.).

**Output Load Transient Response (PD\*)**

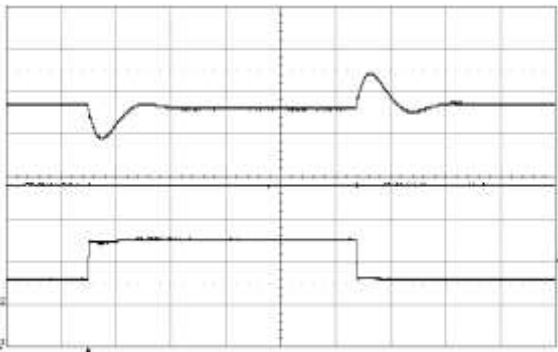

Output voltage response to load current step-change, output 2 (0.9-2.7-0.9 A) at:  $T_{P1} = +25\text{ °C}$ ,  $V_i = 53\text{ V}$ ,  $I_{O1} = 0\text{ A}$ ,  $I_{O3} = 0.15\text{ A}$ , electronic load,  $C_{O2} = 360\text{ }\mu\text{F}$

Top trace: output 2 voltage (0.2 V/div.).  
 Mid trace: output 3 voltage (0.2 V/div.).  
 Bottom trace: output 2 current (2 A/div.).  
 Time scale: (0.2 ms/div.).

## Technical Specification

**PIM 4328 series Power Interface Module**  
 Input 36-75 V, Output up to 10-12 A / 540-648 W

28701-BMR4550003 Rev C November 2017

© Flex

## Typical ATCA Application Circuit

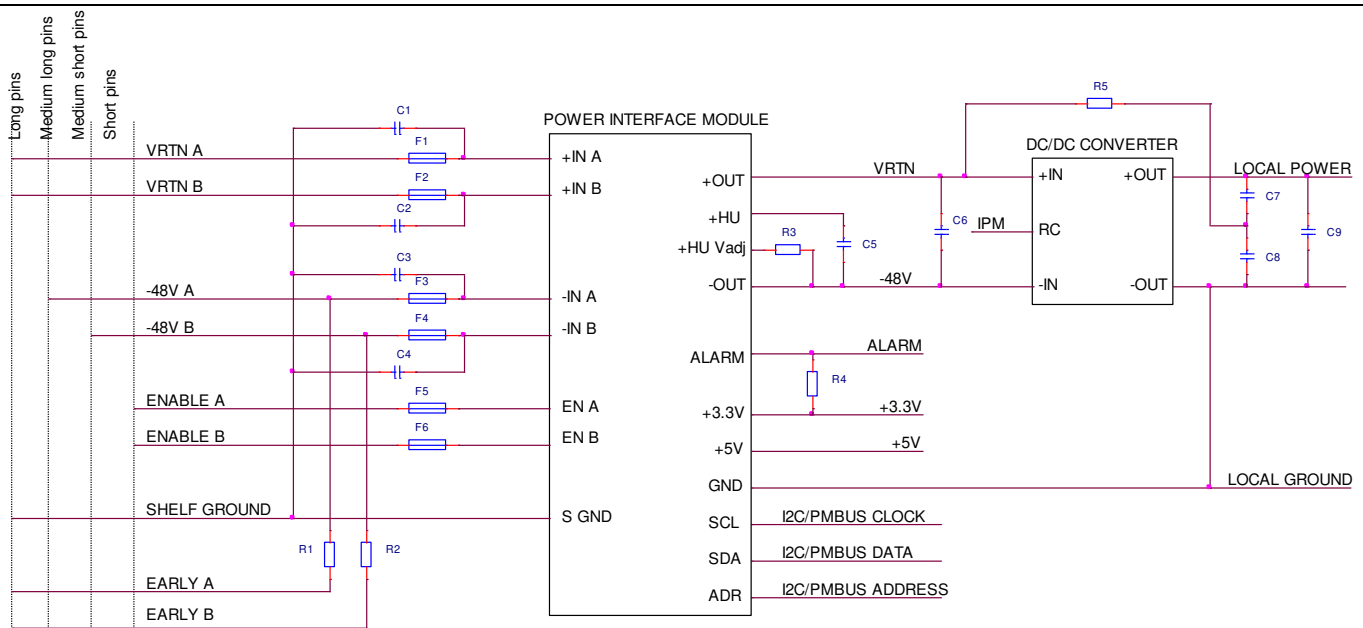
**External components**

C1 – C4, C7- C8 = EMI suppression capacitors (recommended 22 nF)

C5 = hold up capacitor,  $C_{HU}$  (max 3300  $\mu$ F)

C6 = DC/DC converter input capacitor,  $C_{O1}$  (see technical specification for the DC/DC converter)

C9 = DC/DC converter output capacitor (see technical specification for the DC/DC converter)

F1 = fuse (recommended 15 A)

F2 = fuse (recommended 15 A)

F3 = fuse (recommended 15 A)

F4 = fuse (recommended 15 A)

F5 = fuse (recommended 0.5 A)

F6 = fuse (recommended 0.5 A)

R1 = pre-charge resistor, input A (recommended 100  $\Omega$ , max 0.5 A, max 0.1 s)

R2 = pre-charge resistor, input B (recommended 100  $\Omega$ , max 0.5 A, max 0.1 s)

R3 = hold up voltage adjust resistor,  $R_{HU}$  (see Hold Up Capacitor Charge section)

R4 = alarm pull-up resistor (recommended 3.3 k $\Omega$ )

R5 = part of EMI suppression (recommended 22  $\Omega$ )

(IPM = Intelligent Platform Management (see ATCA specification PICM 3.0))



Technical Specification

**PIM 4328 series Power Interface Module**  
 Input 36-75 V, Output up to 10-12 A / 540-648 W

28701-BMR4550003 Rev C November 2017

© Flex

**EMC Specification**

The product contains an EMI filter which is designed to meet the requirements according to EN55022, CISPR 22 and FCC part 15J class B (see test set up), when used in conjunction with Flex BMR 456 DC/DC converter at its maximum load.

**Conducted EMI Input terminal peak value (typ)**

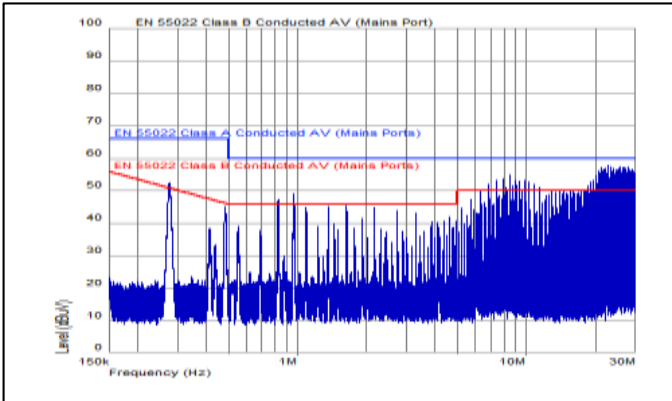

in combination with BMR 456 0004  
 $V_1 = 48\text{ V}$ ,  $C_{O1} = 220\ \mu\text{F}$ ,  $I_{O1} = 8.75\text{ A}$  ( $I_{BMR4560004} = 35\text{ A}$ ),  $I_{O2} = 3.6\text{ A}$ ,  
 $I_{O3} = 0\text{ A}$ , no external emi suppression.

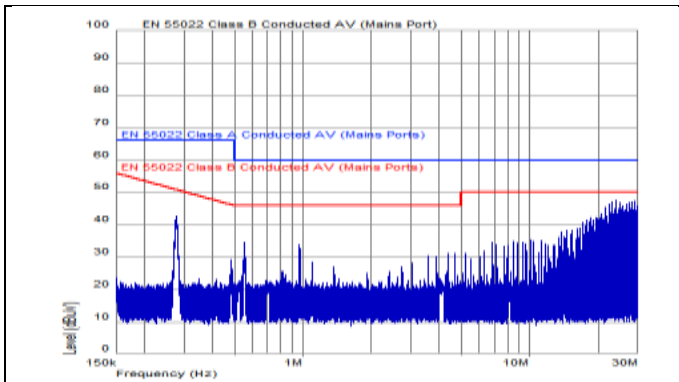

in combination with BMR 456 0004  
 $V_1 = 48\text{ V}$ ,  $C_{O1} = 220\ \mu\text{F}$ ,  $I_{O1} = 8.75\text{ A}$  ( $I_{BMR4560004} = 35\text{ A}$ ),  $I_{O2} = 3.6\text{ A}$ ,  
 $I_{O3} = 0\text{ A}$ ,  $C_1 - C_4$ ,  $C_7 - C_8 = 22\text{ nF}$

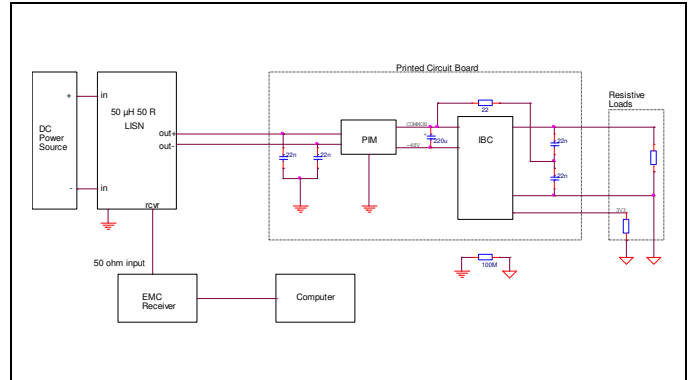

Test set-up, only EMI critical suppression components shown.

**Layout recommendations**

The radiated EMI performance of the product will depend on the PCB layout and ground layer design. It is also important to consider the stand-off of the product.

A ground layer will increase the stray capacitance in the PCB and improve the high frequency EMC performance. For more information, see the technical specification for the downstream DC/DC converter.

## Technical Specification

<b>PIM 4328 series Power Interface Module</b> Input 36-75 V, Output up to 10-12 A / 540-648 W	28701-BMR4550003 Rev C    November 2017
	© Flex

## Operating information

### Input Voltage

The input voltage range 36 to 72 Vdc meets the requirements of the European Telecom Standard ETS 300 132-2 for normal input voltage range in -48 and -60 Vdc systems, -40.5 to -57.0 V and -50.0 to -72 V respectively.

At input voltages exceeding 72 V, the power loss will be higher than at normal input voltage and  $T_{P1}$  must be limited to absolute max 125 °C. The absolute maximum continuous input voltage is 75 Vdc.

### Input Enable

The product has two Enable inputs which shall be connected to feed A and feed B supply of the backplane. The enable pins of the ATCA board are the last to be connected during board insertion and the first to be disconnected during board exertion. The product is switched off until one enable input is connected to the supply (EN A connected to +IN A or EN B connected to +IN B).

### A/B Feed ORing

Two or four MOSFETs (depending on model) provide ORing of the input feeds. If a short is detected on one of the feeds a control circuit will detect reverse current and quickly turn the MOSFET off. This feature will also protect the product against reverse polarity of up to 60 V. At high load operation the MOSFETs are operated at a low  $R_{dson}$  condition and at zero load they are turned off.

### A/B Feed Alarm

The input feeds A and B are monitored. In case of a feed loss the alarm pin will indicate a fault condition which is provided by an opto isolated signal. Under normal conditions the ALARM output goes low (low resistance to GND) and in case of a feed loss the ALARM output goes open drain (high voltage with a pull-up).

### Management Power

The product provides two isolated DC outputs, 3.3 V and 5 V referred to GND. The management power is available as soon as the input voltage level is within 36 V to 72 V. The outputs are short circuit protected. In a short circuit condition the 3.3 V output will operate in a constant current mode and the 5 V output will operate in hiccup mode. A 2.2  $\mu$ F ceramic capacitor and a 10  $\mu$ F tantalum capacitor on the 3.3 V output is recommended to reduce switching noise and improve transient characteristics.

Management power will still be on for max 100 ms after enable A and B have dropped below enable turn-off threshold voltage.

### Hot Swap Functionality

The hot swap function is designed to control the inrush current to the downstream DC/DC converter. The level and duration of the inrush current complies with the PICMG 3.0 ATCA base specification Inrush transient specifications.

Note: The hot swap circuit limits the output 1 current during start up. Hence, output 1 can not be loaded before its external filter capacitor has been charged.

### Hold Up Capacitor Charge

An internal DC/DC converter charges the hold up capacitor to a voltage of 40 V – 95 V. The charge level is set by an external resistor.

Resistor connected between +HU Vadj and -OUT for hold up voltages from 50 to 95 V:

$$R_{HU} = \frac{500}{V_{HU} - 50} - 10 \quad [k\Omega]$$

where  $V_{HU}$  is the hold up voltage.

Resistor connected between +HU Vadj and +HU for hold up voltages from 40 to 50 V:

$$R_{HU} = \frac{200 \times V_{HU} - 500}{50 - V_{HU}} - 10 \quad [k\Omega]$$

where  $V_{HU}$  is the hold up voltage.

No trim resistor results in 50 V hold up voltage.

The hold up capacitor will be connected to the power train and provide energy to the system whenever the voltage on both A and B feeds has dropped below 36 V. When the voltage level on one or either feeds has returned the hold up capacitor will go off line and be recharged. The hold up capacitance is calculated by the following formula:

$$C_{HU} \geq \frac{2 \times P \times t_{HU}}{V_{HU}^2 - V_{Th}^2} \quad [\mu F]$$

where P is the power of the downstream DC/DC converter,  $t_{HU}$  is the hold up time [ $\mu$ s],  $V_{HU}$  is the hold up voltage and  $V_{Th}$  is the minimum voltage threshold of the downstream DC/DC converter.

When the enable inputs are disconnected the hold up and output capacitor will be discharged to less than 60 V within 1 s, conditions:  $V_{HU} = 75$  V,  $V_I = 60$  V,  $C_{O1} = 220$   $\mu$ F.

If hold up is not used (pin 16 and 18), these pins can be left open.

**PIM 4328 series Power Interface Module**  
 Input 36-75 V, Output up to 10-12 A / 540-648 W

28701-BMR4550003 Rev C November 2017

© Flex

**Hold Up Event Voltage**

The resulting voltage across the output capacitor at a hold up event depends on the selected hold up voltage and the relation between hold up- and output capacitance. Maximum allowed hold up capacitance can be calculated using the following formula:

$$C_{HU} = \frac{(C_{O1} + 10) \times (VRTN - 36.8)}{V_{HU} - VRTN} \quad [\mu F]$$

where  $C_{HU}$  is the hold up capacitance,  $C_{O1}$  is the output capacitance [ $\mu F$ ],  $VRTN$  is the input voltage for the down stream DC/DC converter and  $V_{HU}$  is the hold up voltage. Make sure that the resulting voltage is lower than maximum specified input voltage for the downstream DC/DC converter.

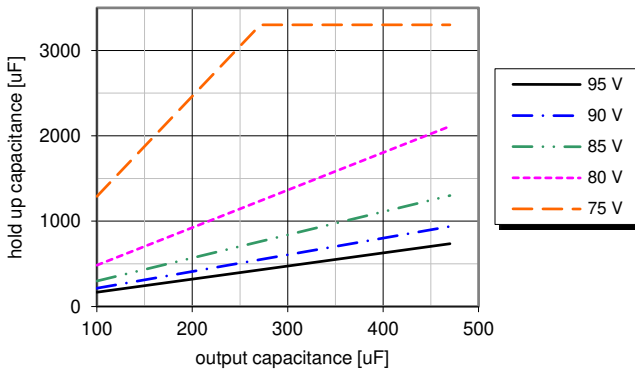

The chart shows output- and hold up capacitances at different hold up voltages for maximum 72 V peak input voltage to the downstream DC/DC converter.

The typical slew rate of a hold up event is approximately 70 V/ms at  $V_{HU} = 75 V$ ,  $C_{HU} = 3 \times 470 \mu F$ ,  $P_{O1} = 300 W$ ,  $I_{O2} = 3 A$ ,  $I_{O3} = 0 A$ . The slew rate increases with increased hold up voltage and capacitance.

**Hold Up Safe Operating Area**

The product must be protected from over stress by limiting the hold up voltage for larger hold up capacitors.

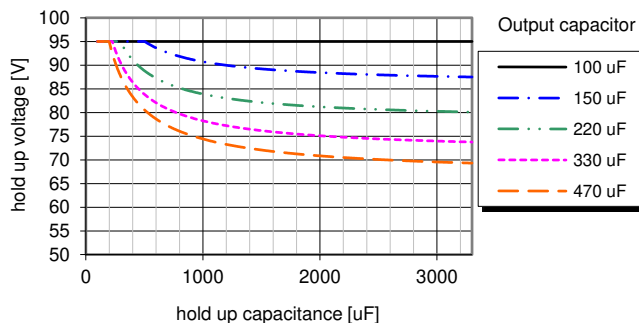

The chart shows maximum allowed hold up voltage and hold up capacitor at different output capacitors.

**Over Temperature Protection (OTP)**

The products are protected from thermal overload by an internal over temperature shutdown circuit. When  $T_{P1}$  as defined in thermal consideration section exceeds 115 °C the product will shut down. The product will make continuous attempts to start up (non-latching mode) and resume normal operation automatically when the temperature has dropped > 5 °C below the temperature threshold. In an over temperature situation the management power is still available.

**Input Transient Over Voltage Protection**

The product incorporates a transient voltage protector which will protect the product and the downstream DC/DC converter against over voltage transients exceeding 75 V. The transient voltage protector is rated for 1.5 kW (10/1000  $\mu s$ ) peak pulse power with a breakdown voltage of 71.1 V. The product also handles transients of up to 100 V for 10  $\mu s$ .

**Over Current Protection (OCP)**

Both the main unit (Output 1) and the management power (Output 2 and Output 3) of the product include current limiting circuitry for protection at continuous overload. The load distribution should be designed for the maximum output short circuit current specified.

The main unit (Output 1) will abruptly be interrupted if the output over current or an internal component overpower thresholds are exceeded for a time longer than the stated fault response time.

The output 2 voltage will decrease towards zero for output currents in excess of max output current. The product will resume normal operation after removal of the overload.

The Output 3 has internal short circuit protection to protect the IC when the output is over loaded or shorted to ground. To avoid damage when output is shorted to ground, the short circuit protection circuitry senses the output voltage and adjusts bias voltage down to clamp the maximum output current to a lower value, 80 mA (typ).

## Technical Specification

<b>PIM 4328 series Power Interface Module</b> Input 36-75 V, Output up to 10-12 A / 540-648 W	28701-BMR4550003 Rev C    November 2017
	© Flex

**Increased output 1 maximum current 12 A (PD\*)**

Maximum continuous current is chosen to 10 A in order to ensure sufficient headroom for current transients (between 10 A and the current limit trip point). Such transients could be the result of a sudden change in input voltage due to a feed switch for instance. The maximum output current may be extended to 12 A, however, to maintain operation during an input voltage transient, ANSI T1.315-2001 (R2006), a hold-up time of 2.5 ms at  $C_{O1} = 220 \mu\text{F}$  and 4.5 ms at  $C_{O1} = 470 \mu\text{F}$  is required.

**Thermal Consideration****General**

The products are designed to operate in different thermal environments and sufficient cooling must be provided to ensure reliable operation.

For products mounted on a PCB without a heat sink attached, cooling is achieved mainly by conduction, from the pins to the host board, and convection, which is dependant on the airflow across the product. Increased airflow enhances the cooling of the product. The Output Current Derating graph found in the Output section for each model provides the available output current vs. ambient air temperature and air velocity at  $V_1 = 53 \text{ V}$ .

A guard band of 5 °C is applied to the maximum recorded component temperatures when calculating output current derating curves.

The product is tested on a 254 x 254 mm, 35  $\mu\text{m}$  (1 oz), 16-layer test board mounted vertically in a wind tunnel with a cross-section of 608 x 203 mm.

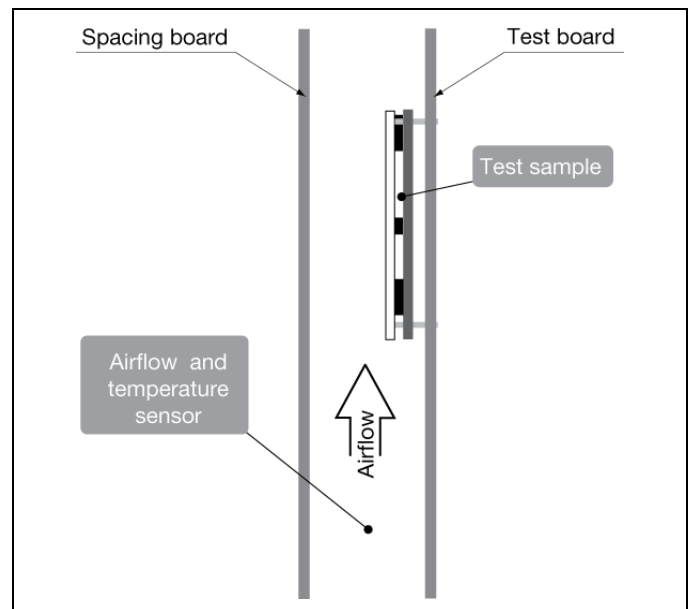

Technical Specification

**PIM 4328 series Power Interface Module**  
 Input 36-75 V, Output up to 10-12 A / 540-648 W

28701-BMR4550003 Rev C November 2017

© Flex

**Definition of product operating temperature**

The product operating temperature is used to monitor the temperature of the product, and proper thermal conditions can be verified by measuring the temperature at position P1 and P2. The temperature at these positions ( $T_{P1}$  and  $T_{P2}$ ) should not exceed the maximum temperature in the table below. Temperature above maximum  $T_{P1}$  and  $T_{P2}$  (FUNCTIONAL INSULATION), measured at the reference points P1 and P2 is not allowed and may cause permanent damage.

BASIC INSULATION is provided if the temperature at position P2 ( $T_{P2}$ ) is limited to the maximum temperature in the table below. Temperature above maximum  $T_{P2}$  (BASIC INSULATION), measured at the reference point P2 is not allowed for BASIC INSULATION. If maximum  $T_{P2}$  (BASIC INSULATION) is exceeded the product provides FUNCTIONAL INSULATION only.

Position	Description	Max Temp.
P1	Opto coupler	P*: $T_{P1} = 110\text{ }^{\circ}\text{C}$
		PD*: $T_{P1} = 100\text{ }^{\circ}\text{C}$
P2	Transformer	$T_{P2} = 130\text{ }^{\circ}\text{C}$ (FUNCTIONAL INSULATION) $T_{P2} = 90\text{ }^{\circ}\text{C}$ (BASIC INSULATION)

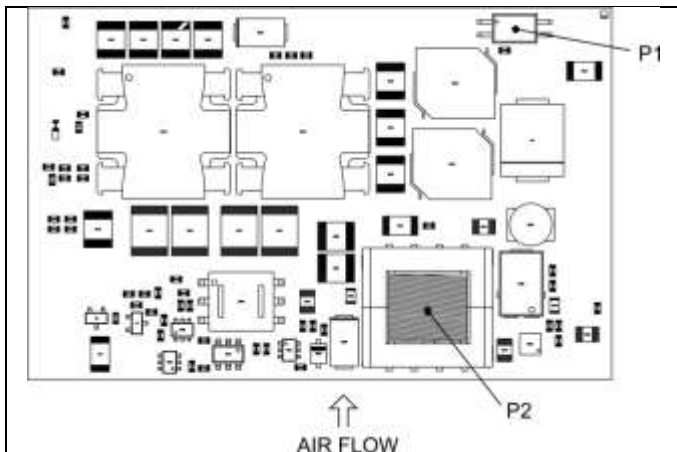

**Connections**

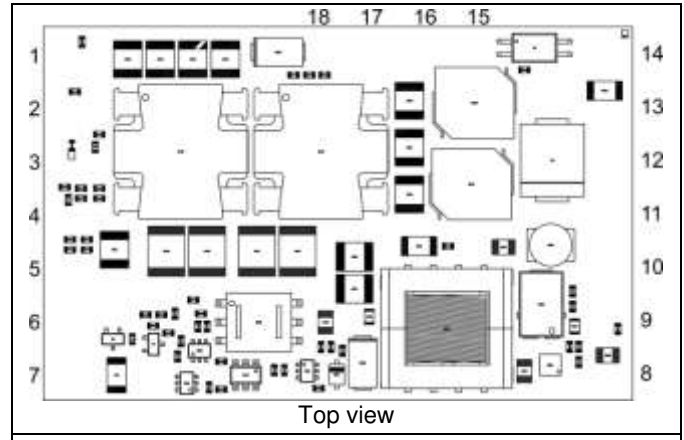

Pin	Designation	Function
1	-IN A	Input A negative feed
2	-IN B	Input B negative feed
3	+IN A	Input A positive feed
4	+IN B	Input B positive feed
5	A EN	Input A enable
6	B EN	Input B enable
7	S GND	Shelf ground
8	+5V	Management power, positive output 5 V
9	+3.3V	Management power, positive output 3.3 V
10*	ADR	I <sup>2</sup> C/PMBus address
11*	SDA	I <sup>2</sup> C/PMBus data
12*	SCL	I <sup>2</sup> C/PMBus clock
13	GND	Management power, negative output
14	ALARM	Feed loss alarm
15	-OUT	Main unit, negative output
16	+HU Vadj	Hold-up voltage adjust
17	+OUT	Main unit, positive output
18	+HU	Hold-up capacitor bank, positive side

\* Only available on PD\*-version

## Technical Specification

**PIM 4328 series Power Interface Module**  
Input 36-75 V, Output up to 10-12 A / 540-648 W

28701-BMR4550003 Rev C November 2017

© Flex

**I<sup>2</sup>C/PMBus Interface (PD\*)**

This product provides an I<sup>2</sup>C/PMBus digital interface that enables the user to monitor the input and hold up voltages, output current and device temperature. The product is available in a PMBus-version (PIM 4328 PD) and an I<sup>2</sup>C-version (PIM 4328 PDA). The product can be used with any standard two-wire I<sup>2</sup>C or SMBus host device. In addition, the PMBus-version of the module is compatible with PMBus version 1.2. The product supports bus clock frequencies from 10 to 400 kHz. External pull-up resistors must be added to the I<sup>2</sup>C/PMBus.

**Monitoring via I<sup>2</sup>C/PMBus**

It is possible to monitor a variety of different parameters and status/fault flags through the I<sup>2</sup>C/PMBus interface. It is also possible to continuously monitor one or more of the below parameters:

## Monitored parameters

- Feed A voltage
- Feed B voltage
- Output current
- Hold up voltage
- Internal junction temperature

## Monitored status/fault flags

- Feed under voltage
- Output 1 under voltage
- Hot swap off

**I<sup>2</sup>C/PMBus Addressing**

The PMBus address should be configured with a resistor connected between ADR (pin 10) and GND (pin 13), as shown in the figure below. Recommended resistor values for hard-wiring I<sup>2</sup>C/PMBus addresses are shown in the table. 1% tolerance resistors are required.

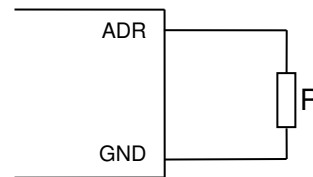

Schematic of connection of address resistor.

I <sup>2</sup> C Address	R (Ω)
2Fh	open
2Eh	100000
2Dh	40200
2Ch	20000
2Bh	10000
2Ah	4020
29h	2000
28h	short

The user can theoretically configure up to 8 unique I<sup>2</sup>C/PMBus addresses.

## Technical Specification

**PIM 4328 series** Power Interface Module  
Input 36-75 V, Output up to 10-12 A / 540-648 W

28701-BMR4550003 Rev C November 2017

© Flex

**PMBus-version (PD)****PMBus Commands**

The product is PMBus compliant. The following table lists the implemented PMBus commands. For more detailed information see PMBus Power System Management Protocol Specification; Part I – General Requirements, Transport and Electrical Interface and PMBus Power System Management Protocol; Part II – Command Language.

Designation	Cmd	Impl
CLEAR_FAULTS	03h	Yes
PMBUS_COEFFICIENTS	30h	Yes
STATUS_BYTE	78h	Yes
READ_VIN (DIRECT)	88h	Yes
READ_VCAP (DIRECT)	8Ah	Yes
READ_IOUT (DIRECT)	8Ch	Yes
READ_TEMPERATURE_1 (DIRECT)	8Dh	Yes
PMBUS_REVISION	98h	Yes
MFR_ID	99h	Yes
MFR_MODEL	9Ah	Yes
MFR_REVISION	9Bh	Yes
MFR_LOCATION	9Ch	Yes
MFR_DATE	9Dh	Yes
MFR_SERIAL	9Eh	Yes
MFR_READ_VINA (DIRECT)	D3h	Yes
MFR_READ_VINB (DIRECT)	D4h	Yes
MFR_STATUS_BITS	D5h	Yes
MFR_FIRMWARE_DATA	FDh	Yes

## Notes:

Cmd is short for Command.

Impl is short for Implemented.

CLEAR\_FAULTS only supports clearing of the CML bit.

STATUS\_BYTE only supports reading of the CML bit.

DIRECT\_value is represented in PMBus DIRECT format.

The coefficients are obtained using the PMBUS\_COEFFICIENTC cmd; see PMBus specification rev. 1.2 chapters 7.2 and 14.1.

**MFR\_STATUS\_BITS**

A read only register that display any current status.

Designation	Bit	Function
ENABLE_A	0	Enable A signal state. 0 = Disabled. 1 = Enabled.
ENABLE_B	1	Enable B signal state. 0 = Disabled. 1 = Enabled.
ALARM	2	Alarm signal state. 0 = Feed loss alarm ceased. 1 = Feed loss alarm raised.
N/A	3	Reserved
HOLDUP	4	Hold up switch state. 0 = Hold up Capacitor is not connected to Output 1. 1 = Hold up Capacitor is connected to Output 1.
HOTSWAP	5	Hot swap switch state. 0 = Switch is off. Output 1 is off. 1 = Switch is on. Output 1 is on.
VOUT_LOW	6	Output 1 Under-Voltage Alarm. 0 = Output voltage is below threshold. 1 = Output voltage is above threshold.
N/A	7	Reserved

Technical Specification

**PIM 4328 series** Power Interface Module  
 Input 36-75 V, Output up to 10-12 A / 540-648 W

28701-BMR4550003 Rev C November 2017

© Flex

**I<sup>2</sup>C-version (PDA)**

**I<sup>2</sup>C Interface**

Via the I<sup>2</sup>C interface five analog measurements and six status bits can be read. The 8-bit values read via I<sup>2</sup>C must be multiplied by the scaling factors to get the measurement value. For the temperature reading an offset of 50°C must be subtracted after multiplying with the scaling factor.

Designation	Data pointer	Description	Scaling factor
StatusBits	1Eh	See table StatusBits	Bit field
HU_CAP	1Fh	Hold-up capacitor voltage	0.398 V/bit
-48V_Current	21h	Output1 current	0.094 A/bit
-48V_A	22h	Feed A input voltage	0.325 V/bit
-48V_B	23h	Feed B input voltage	0.325 V/bit
Temperature	28h	Module temperature	(1.961°C /bit) - 50°C

**StatusBits**

A read only register that display current status.

Designation	Bit	Function
ENABLE_A	0	Enable A signal state. 0 = Disabled. 1 = Enabled.
ENABLE_B	1	Enable B signal state. 0 = Disabled. 1 = Enabled.
ALARM	2	Alarm signal state. 0 = Feed loss alarm ceased. 1 = Feed loss alarm raised.
N/A	3	Reserved
HOLDUP	4	Hold up switch state. 0 = Hold up Capacitor is not connected to Output 1. 1 = Hold up Capacitor is connected to Output 1.
HOTSWAP	5	Hot swap switch state. 0 = Switch is off. Output 1 is off. 1 = Switch is on. Output 1 is on.
VOUT_LOW	6	Output 1 Under-Voltage Alarm. 0 = Output voltage is below threshold. 1 = Output voltage is above threshold.
N/A	7	Reserved

**I<sup>2</sup>C Protocol**

To read data through the I<sup>2</sup>C interface the Data pointer must first be written.

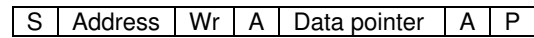

- From master to slave
- From slave to master
- S START condition
- P STOP condition
- A Acknowledge / No acknowledge

If more bytes are written after the Data pointer they will be discarded but the Data pointer will be advanced the number of bytes written.

After the Data pointer has been written data can be read.

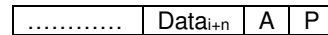
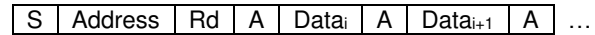

The first byte read will be the value referenced by the Data pointer. Several bytes may be read in one access. For each byte read the Data pointer will be incremented. Reading from an undefined location returns 00h.

The Data pointer is initiated to 00h at power-on and does not overflow when it reaches FFh.

A write may end with a repeat START followed by a read.



Technical Specification

**PIM 4328 series Power Interface Module**  
 Input 36-75 V, Output up to 10-12 A / 540-648 W

28701-BMR4550003 Rev C November 2017

© Flex

**Mechanical Information**

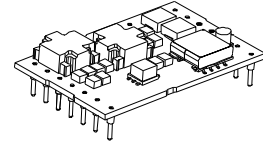
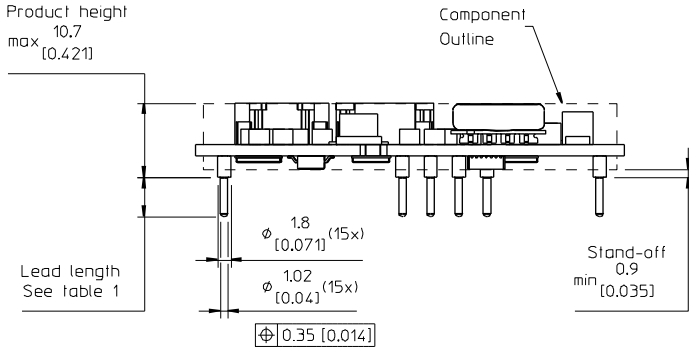

TOP VIEW

Pin positions according to recommended footprint

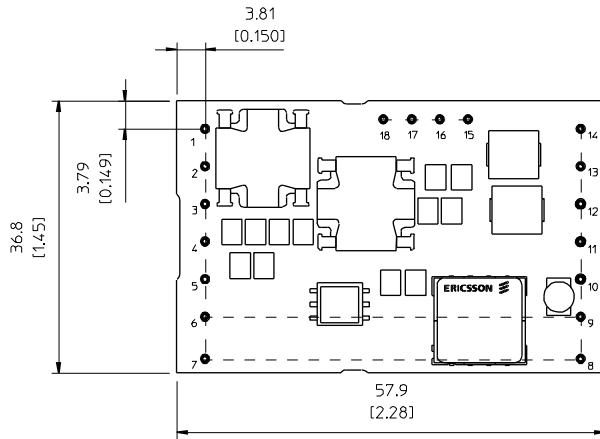

RECOMMENDED FOOTPRINT - TOP VIEW

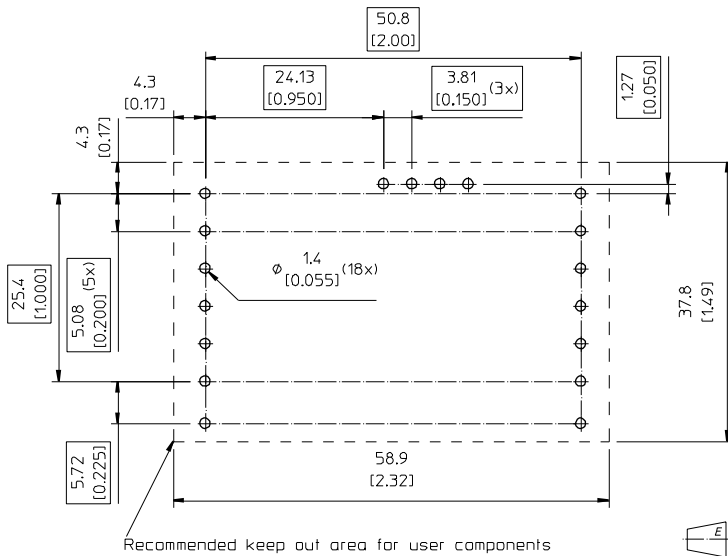

Table 1

Pin option	Lead length
Standard	5.33 [0.21]
LA	3.69 [0.145]
LB	4.57 [0.18]
LC	2.79 [0.11]

Pins:  
 Material: Copper alloy  
 Plating: 10µm Matte Tin over 4µm Nickel  
 Pin positions 10-12 are optional

Weight: Typical 26.1 g  
 All dimensions in mm [inch].  
 Tolerances unless specified  
 x.x mm ±0.50 mm [0.02], x.xx mm ±0.25 mm [0.01]  
 (not applied on footprint or typical values)

All component placements – whether shown as physical components or symbolical outline – are for reference only and are subject to change throughout the product's life cycle, unless explicitly described and dimensioned in this drawing.

Technical Specification

**PIM 4328 series Power Interface Module**  
 Input 36-75 V, Output up to 10-12 A / 540-648 W

28701-BMR4550003 Rev C November 2017

© Flex

**Soldering Information - Hole Mounting**

The hole mounted product is intended for plated through hole mounting by wave or manual soldering. The pin temperature is specified to maximum to 270°C for maximum 10 seconds.

A maximum preheat rate of 4°C/s and maximum preheat temperature of 150°C is suggested. When soldering by hand, care should be taken to avoid direct contact between the hot soldering iron tip and the pins for more than a few seconds in order to prevent overheating.

A no-clean flux is recommended to avoid entrapment of cleaning fluids in cavities inside the product or between the product and the host board. The cleaning residues may affect long time reliability and isolation voltage.

**Delivery Package Information**

The products are delivered in antistatic trays.

Tray Specifications	
<b>Material</b>	Antistatic PE foam
<b>Surface resistance</b>	$10^5 < \text{Ohm/square} < 10^{11}$
<b>Bakeability</b>	The trays are not bakeable
<b>Tray thickness</b>	24.0 mm [0.945 inch]
<b>Box capacity</b>	20 products (1 full tray/box)
<b>Tray weight</b>	43 g empty, 565 g full tray

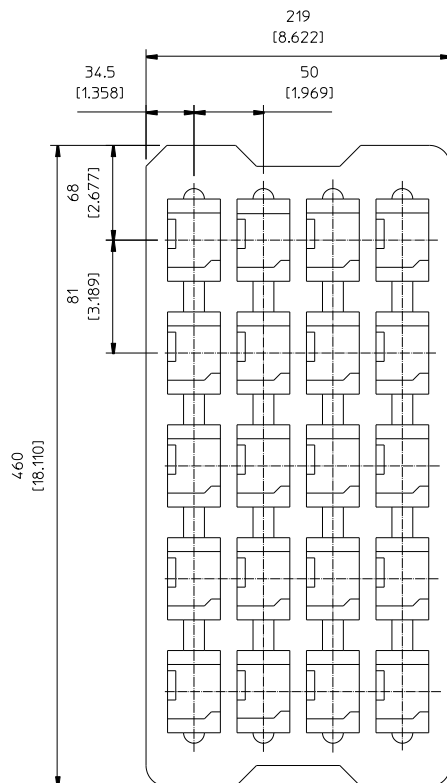

## Technical Specification

PIM 4328 series Power Interface Module Input 36-75 V, Output up to 10-12 A / 540-648 W	28701-BMR4550003 Rev C November 2017
	© Flex

## Product Qualification Specification

Characteristics			
External visual inspection	IPC-A-610		
Change of temperature (Temperature cycling)	IEC 60068-2-14 Na	Temperature range Number of cycles Dwell/transfer time	-40 to 100°C 1000 15 min/0-1 min
Cold (in operation)	IEC 60068-2-1 Ad	Temperature T <sub>A</sub> Duration	-45°C 72 h
Damp heat	IEC 60068-2-67 Cy	Temperature Humidity Duration	85°C 85 % RH 1000 hours
Dry heat	IEC 60068-2-2 Bd	Temperature Duration	125°C 1000 h
Electrostatic discharge susceptibility	IEC 61340-3-1, JESD 22-A114 IEC 61340-3-2, JESD 22-A115	Human body model (HBM) Machine Model (MM)	Class 2, 2000 V Class 3, 200 V
Immersion in cleaning solvents	IEC 60068-2-45 XA, method 2	Water Glycol ether Isopropyl alcohol	55°C 35°C 35°C
Mechanical shock	IEC 60068-2-27 Ea	Peak acceleration Duration	100 g 6 ms
Moisture reflow sensitivity <sup>1</sup>	J-STD-020C	Level 1 (SnPb-eutectic) Level 3 (Pb Free)	225°C 260°C
Operational life test	MIL-STD-202G, method 108A	Duration	1000 h
Resistance to soldering heat <sup>2</sup>	IEC 60068-2-20 Tb, method 1A	Solder temperature Duration	270°C 10-13 s
Robustness of terminations	IEC 60068-2-21 Test Ua1 IEC 60068-2-21 Test Ue1	Through hole mount products Surface mount products	All leads All leads
Solderability	IEC 60068-2-58 test Td <sup>1</sup>	Preconditioning Temperature, SnPb Eutectic Temperature, Pb-free	150°C dry bake 16 h 215°C 235°C
	IEC 60068-2-20 test Ta <sup>2</sup>	Preconditioning Temperature, SnPb Eutectic Temperature, Pb-free	Steam ageing 235°C 245°C
Vibration, broad band random	IEC 60068-2-64 Fh, method 1	Frequency Spectral density Duration	10 to 500 Hz 0.07 g <sup>2</sup> /Hz 10 min in each direction

## Notes

<sup>1</sup> Only for products intended for reflow soldering (surface mount products)

<sup>2</sup> Only for products intended for wave soldering (plated through hole products)