

30 Amp Power PCB Relay PTRH



FEATURES

- Popular Power PCB Relay Footprint - T90
- 30 Amp 250 VAC General Purpose UL Rating
- 2 HP 250 VAC Rating
- UL Class F Insulation Available
- Meets UL 508 and UL 873 Spacing with Pin 6 Omitted
- Epoxy Sealed, Immersion Cleanable
- RoHS Compliant

UL / CUL Ratings

UL **us** **E93379**

Load Type	Voltage	1 Form A (SPST-NO)	1 Form B (SPDT-NC)	1 Form C (SPDT)	
				NO	NC
General Purpose	240 VAC*	30 A*	20 A*	30 A*	20 A*
	30 VDC	30 A	20 A	30 A	20 A
Resistive (100,000 Cycles)	250 VAC	30 A	20 A	30 A	20 A
Motor (30,000 Cycles)	250 VAC	2 HP	---	2 HP	---
	120 VAC	1 HP	1.5 HP	1 HP	1.5 HP
LRA/FLA	240 VAC	/12 A	---	/12	30 A/10 A
	120 VAC	/16 A	---	/16	30 A/10 A

* UL Approved

CONTACT DATA

Material	AgCdO, AgSnO ₂ In ₂ O ₃ ; AgCdO+Au	
Initial Contact Resistance	50 mΩ Max. @ 1 A, 6 VDC	
Maximum Switching Voltage	110 VDC, 300 VAC	
Maximum Switching Current	30 A	
Maximum Switching Power	900 W, 7,500 VA	
Service Life	Mechanical	1 X 10 ⁷ Operations
	Electrical	5 X 10 ⁴ Operations

*6 Pin version meets UL 508
 5 Pin (-1) version meets UL 508 and UL 873 spacing - 3.18 mm through air, 6.36 mm over surface.

CHARACTERISTICS

Operate Time	Less than 15 ms
Release Time	Less than 10 ms
Insulation Resistance	1,000 MΩ min, at 500 VDC, 50% RH
Dielectric Strength	50 Hz 2,500 V 1 Min Between Coil and Contacts
	4,000 V without Pin 6
	50 Hz 1,500 V 1 min. Between Contacts
Shock Resistance	200 m/s, 11 ms
Vibration Resistance	10 - 55 Hz Double Amplitude
Power Consumption	0.9 W Standard, 0.6 W & 1.1 W Optional

CHARACTERISTICS Continued

Terminal Strength	10N
Solderability	260 °C for 5 seconds
Operating Temperature Range	-40°C to 100°C Class B
Operating Temperature Range	-40°C to 125°C Class F
Relative Humidity	85% (at 40°C)
Weight	30 grams, 27 grams Open Frame
Material Compliant To	EU RoHS V2, EU REACH V3

ORDERING INFORMATION

Example:	PTRH	-1C	-12	S	T	-1	-X
Model:	PTRH						
Contact Form:	1A, 1B, 1C						
Coil Voltage:	3, 5, 6, 9, 12, 15, 18, 24, 28, 48, 110						
Enclosure:	Nil: Open Frame; S: Sealed; C: Dust Cover						
Insulation Material:	Nil: Class B; F: Class F						
Contact Material:	Nil: AgCdO; T: AgSnO₂In₂O₃						
Spacing:	Nil: UL508; -1: UL 508 and UL 873 (Pin #6 Omitted)						
RoHS Compliant:	-X						
Coil Sensitivity:	Nil: 0.9 W**; 0.6: 0.6 W; 1.1: 1.1 W (**0.9 W is Industry Standard)						
Gold Plated Contacts:	Nil: None; G: AgCdO+Au						

Box Quantity: 600; Inner Box 300

COIL DATA

Coil Voltage		Coil Power (W)			Coil Power (W)		Must Release Voltage Min (VDC)
Rated	Max	Resistance (Ohms ± 10%)			Must Operate Voltage Max (VDC)		
		0.6 W	0.9 W	1.1 W	0.6 W & 0.9 W	1.1 W	
3	3.9	15	10	—	2.25	—	0.3
5	6.5	42	28	—	3.75	—	0.5
6	7.8	60	40	33	4.50	4.8	0.6
9	11.7	135	90	—	6.75	—	0.9
12	15.6	240	150	131	9.00	9.6	1.2
15	19.5	375	260	—	10.25	—	1.5
18	23.4	540	360	—	13.50	—	1.8
24	31.2	960	640	524	18.00	19.2	2.4
28	36.4	1307	871	713	21.0	22.4	2.8
48	62.4	3840	2560	2095	36.00	38.4	4.8
110	143	20167	13445	—	82.50	—	11.0

*0.9 W is Industry Standard

NOTES:

The use of any coil voltage less than the rated voltage will compromise the operation of the relays. Must Operate Voltage and Must Release Voltages are for test purposes only and are not to be used as design criteria.

DIMENSIONS (mm/inches)

Knock off, on top corner, nib for ventilation after soldering and water wash.

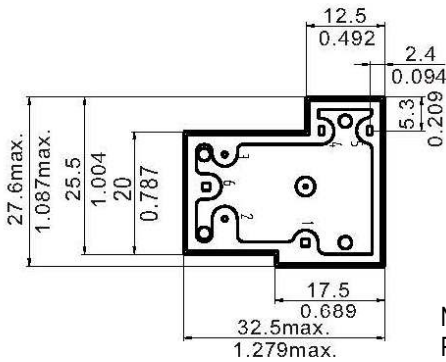

Note:
Power Pins are 0.8 mm x 1.5 mm
Coil Pins are Ø0.8 mm

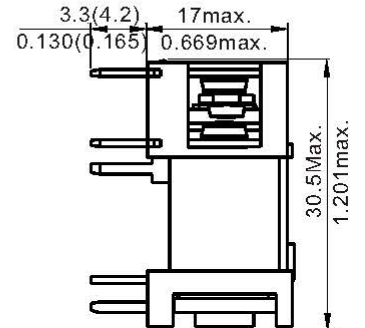
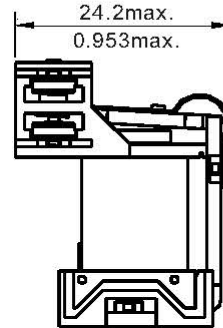

Open type

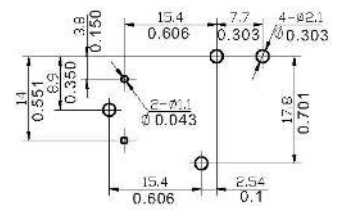
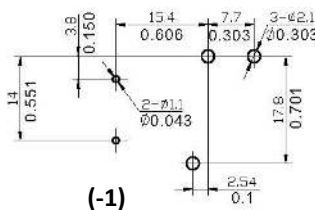
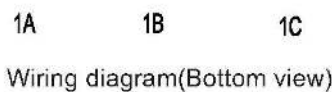
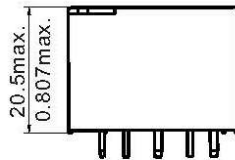
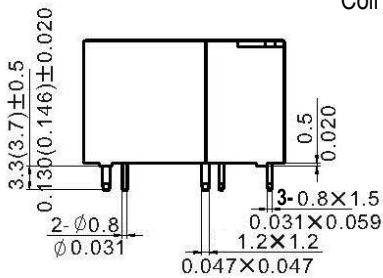

Available with Pin 6 UL508 or Without Pin 6 UL873 (-1)



T90 Style Relays

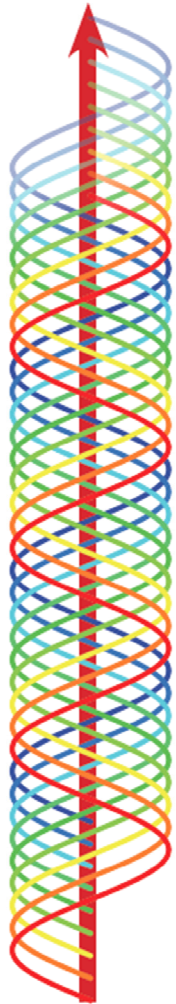
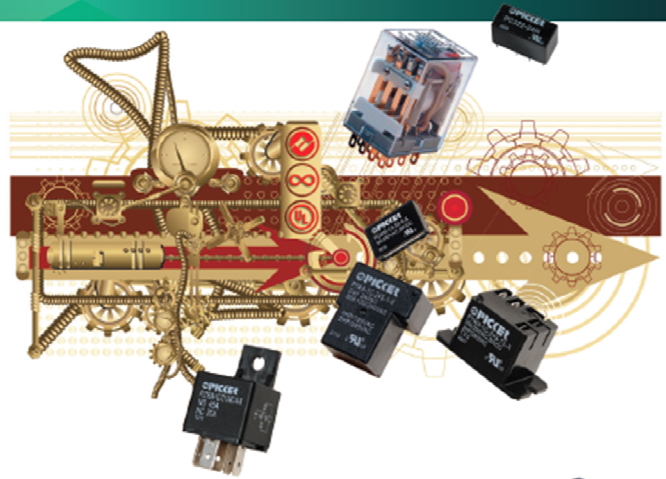

50 Amp

PTRV 50/35 Amp 1,500 W, 12,000 VA

- Larger Contacts than PTRD
- *Braided Copper Wire Added to Dissipate Heat from Contacts to the Coil Frame and PCB Pins*
- 50 Amp 240 VAC 10,000 Cycle UL Resistive Rating
- Class F Material -40° to 125° C Standard

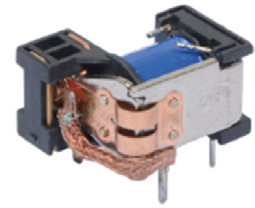

45 Amp

New

PTRV 45 Amp 277 VAC 12,500 VA

- >1.8 mm Contact Gap
- 2.25 Watt Coil for Vibration Tolerance
- Class F Material -40° to 85° C Standard
- Designed for PV Inverter & Motor Control Applications



40 Amp

PTRD 40/30 Amp 1,200 W, 10,000 VA **PTRA AC Coil Options from 12 to 277 VAC**

- Larger Contacts than PTRH
- 40 Amp 240 VAC UL Resistive Rating
- 25 Amp 277 VAC 100K Cycles UL Resistive Rating
- Class F Material -40° to 125° C Standard



30 Amp

PTRH 30/20 Amp 900 W, 7,500 VA

- 30 Amp 277 VAC UL General Purpose Rating
- 30 Amp 250 VAC 100K Cycle UL Resistive Rating
- Class B -40° to 100° C Standard, Optional Class F

Packaging Options (i.e. PTRH-T)



Dust Cover or Sealed with Scratch off Nib



-T (T2 & T3) with PC Pins and Contact QC



-T (T4 & T5) w/QC Tabs & Mounting Ears



-OT (OT2 & OT3) with PC Pins and Contact QC



-OT (OT4 & OT5) w/QC Tabs & Mounting Ears

888-997-3933 • PickerComponents.com
Sales@PickerComponents.com

