

0061003018-C

ADVA® 0061003018 Compatible TAA 1000Base-BX SFP Transceiver (SMF, 1310nmTx/1490nmRx, 40km, SC, DOM)

Features:

- SFF-8472 and MSA Compliant
- Up to 1.25Gbps data links
- Simplex SC Connector
- Single-mode fiber
- Single 3.3V power supply
- Commercial Temperature 0 to 70 Celsius
- Support Hot Pluggable
- Metal with lower EMI
- RoHS compliant and Lead Free



Applications:

- 1000Base-BX Ethernet
- 1x Fibre Channel
- Access (FTTx) and Enterprise

Product Description

This ADVA® 0061003018 compatible SFP transceiver provides 1000Base-BX throughput up to 40km over single-mode fiber (SMF) using a wavelength of 1310nmTx/1490nmRx via a SC connector. It is guaranteed to be 100% compatible with the equivalent ADVA® transceiver. This easy to install, hot swappable transceiver has been programmed, uniquely serialized and data-traffic and application tested to ensure that it will initialize and perform identically. Digital optical monitoring (DOM) support is also present to allow access to real-time operating parameters. This transceiver is Trade Agreements Act (TAA) compliant. We stand behind the quality of our products and proudly offer a limited lifetime warranty.

ProLabs' transceivers are RoHS compliant and lead-free.

TAA refers to the Trade Agreements Act (19 U.S.C. & 2501-2581), which is intended to foster fair and open international trade. TAA requires that the U.S. Government may acquire only "U.S. – made or designated country end products."



Absolute Maximum Ratings

Parameter	Symbol	Min.	Typ.	Max.	Unit
Maximum Supply Voltage	Vcc	-0.5		3.6	V
Storage Temperature	Tstg	-40		85	°C
Operating Case Temperature	Tc	0		70	°C
Operating Relative Humidity	RH	5		85	%
Data Rate	GBE		1.25		Gbps
	FC		1.063		Gbps

Notes:

1. Exceeding any one of these values may destroy the device immediately.

Electrical Characteristics

Parameter	Symbol	Min.	Typ.	Max.	Unit	Notes
Power Supply Voltage	Vcc	3.13	3.3	3.47	V	
Power Supply Current	Icc			300	mA	
Transmitter						
LVPECL Differential Inputs	VIN	400		1800	mVp-p	1
Input Differential Impedance	ZIN	90	100	110	Ω	2
Tx_Disable	Disable	2		Vcc+0.3	V	
	Enable	0		0.8	V	
Tx_Fault	Fault	2		Vcc+0.3	V	
	Normal	0		0.8	V	
Receiver						
LVPECL Differential Outputs	VOUT	400		2000	mVp-p	3
Output Differential Impedance	ZOUT	90	100	110	Ω	
Tx_Disable Assert Time	T_off			10	us	
Rx_LOS	LOS	2		Vcc+0.3	V	
	Normal	0		0.8	V	
MOD_DEF(0.2)	VOH	2.5		Vcc+0.3	V	4
	VOL	0		0.5	V	4

Notes:

1. LVPECL logic. Internally AC coupled inputs.
2. RIN>100kΩ @DC.
3. LVPECL logic. Internally AC coupled outputs.
4. With Serial ID.

Optical Characteristics

Parameter	Symbol	Min.	Typ.	Max.	Unit	Notes
9µm Core Diameter SMF	L		40		km	
Data Rate			1.063/1.25		Gbps	
Transmitter						
Center Wavelength	λ_C	1290	1310	1330	nm	
Spectral Width (-20dB)	$\Delta\lambda$			1	nm	
Average Output Power	POUT	-5		0	dBm	1
Extinction Ratio	ER	9			dB	2
Rise/Fall Time (20-80%)	Tr/Tf			0.26	ns	
Total Jitter	TJ			0.43	UI	
Output Optical Eye		Compliant with IEEE802.3				2
POUT @Tx_Disable Asserted	POUT			-35	dBm	
Receiver						
Center Wavelength	λ_C	1450		1540	nm	
Receiver Sensitivity	Pmin			-24	dBm	3
Receiver Overload	Pmax	-3			dBm	
LOS De-Assert	LOSD			-25	dBm	
LOS Assert	LOSA	-35			dBm	
LOS Hysteresis		1		4	dB	3

Notes:

1. Output power is power coupled into a 9/125µm single-mode fiber.
2. Filtered. Measured with a PRBS 2⁷-1 test pattern @1250Mbps.
3. Minimum average optical power is measured at BER<1E⁻¹² with 2⁷-1 PRBS and ER=9dB.

Pin Descriptions

Pin	Symbol	Name/Description	Plug Sequence	Notes
1	VeeT	Transmitter Ground.	1	5
2	Tx_Fault	Transmitter Fault Indication.	3	1
3	Tx_Disable	Transmitter Disable. Module Disables on "High" or "Open."	3	2
4	MOD-DEF2	Module Definition 2. 2-Wire Serial Interface Data.	3	3
5	MOD-DEF1	Module Definition 1. 2-Wire Serial Interface Clock.	3	3
6	MOD-DEF0	Module Definition 0. Grounded Within the Module.	3	3
7	Rate Select	Not Connected.	3	7
8	LOS	Loss of Signal.	3	4
9	VeeR	Receiver Ground.	1	5
10	VeeR	Receiver Ground.	1	5
11	VeeR	Receiver Ground.	1	5
12	RD-	Inverted Received Data Out.	3	
13	RD+	Received Data Out.	3	6
14	VeeR	Receiver Ground.	1	5
15	VccR	Receiver Power. 3.3±5%.	2	6
16	VccT	Transmitter Power. 3.3±5%.	2	6
17	VeeT	Transmitter Ground.	1	5
18	TD+	Transmit Data In.	3	
19	TD-	Inverted Transmit Data In.	3	
20	VeeT	Transmitter Ground.	1	5

Notes:

1. Tx_Fault is an open collector/drain output which should be pulled up with a 4.7kΩ to 10kΩ resistor on the host board. When "high," the output indicates a laser fault of some kind. "Low" indicates normal operation.
2. Tx_Disable is an input that is used to shut down the transmitter optical output. It is pulled up in the module with a 4.7kΩ to 10kΩ resistor. Its states are the following:
 - Low (0V-0.8V): Transmitter On
 - (>0.8V, <2.0V): Undefined
 - High (2.0V-3.465V): Transmitter Disabled
 - Open: Transmitter Disabled.
3. MOD-DEF0, 1, and 2. These are the module definition pins. They should be pulled up with a 4.7kΩ to 10kΩ resistor on the host board.
 - MOD-DEF0 is grounded by the module to indicate that the module is present.
 - MOD-DEF1 is the clock line of the 2-wire serial interface for serial ID.
 - MOD-DEF2 is the data line of the 2-wire serial interface for serial ID.
4. LOS (Loss of Signal) is an open collector/drain output which should be pulled up with a 4.7kΩ to 10kΩ

resistor. When “high,” this output indicates that the received optical power is below the worst-case receiver sensitivity. “Low” indicates normal operation.

5. VeeR and VeeT may be internally connected within the SFP module.
6. VccR and VccT are the receiver and transmitter power supplies. They are defined as $3.3V \pm 5\%$ at the SFP connector pin. Maximum supply current is 300mA. VccR and VccT may be internally connected within the SFP transceiver module.
7. Function not available.

Electrical Pin-Out Details

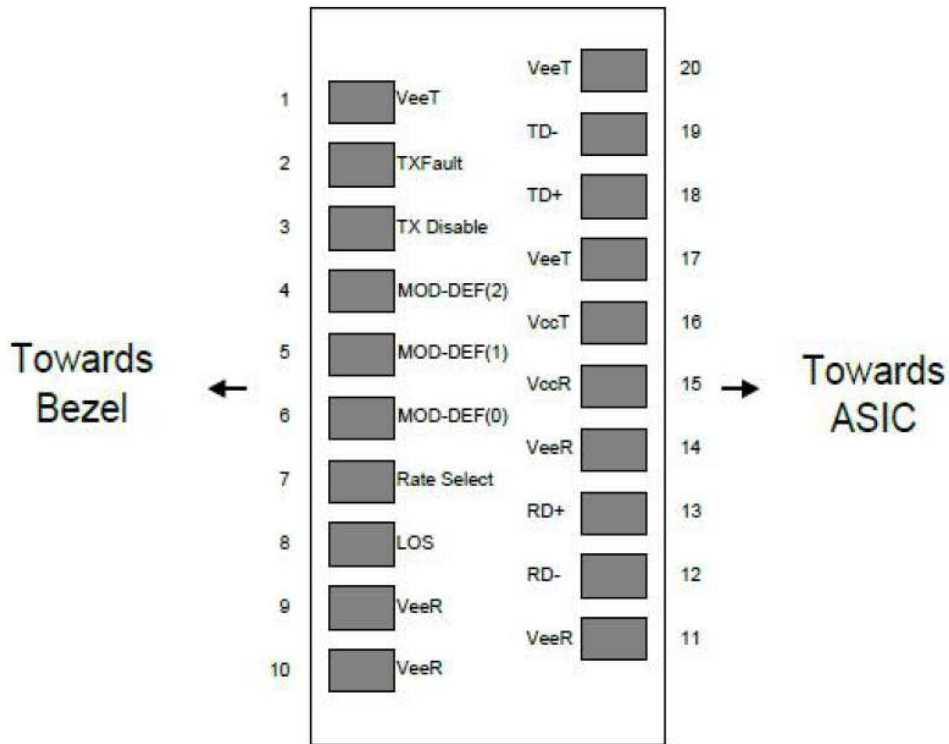

Recommend Circuit Schematic

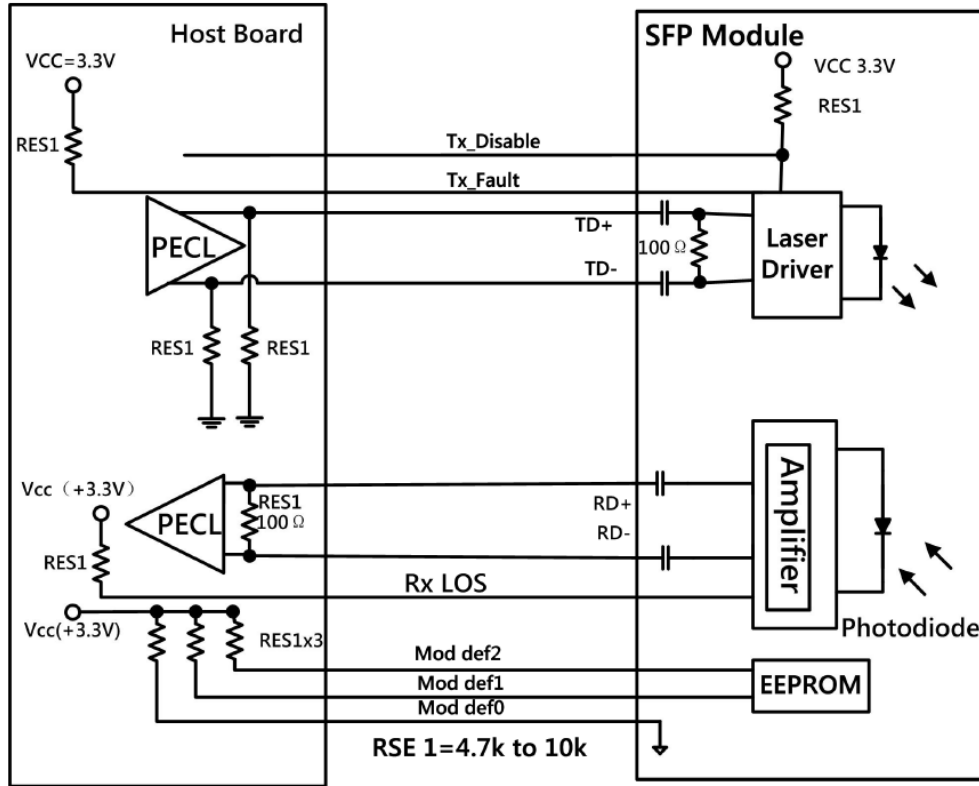

EEPROM

The serial interface uses the 2-wire serial CMOS EEPROM protocol defined for the ATMEL AT24c02/04 family of components. When the serial protocol is activated, the host generates the serial clock signal (SCL). The positive edge clocks data into those segments of the EEPROM that are not write protected within the SFP+ transceiver. The negative edge clocks data from the SFP+ transceiver. The serial data signal (SDA) is bidirectional for serial data transfer. The host uses SDA in conjunction with SCL to mark the start and end of serial protocol activation. The memories are organized as a series of 8-bit data words that can be addressed individually or sequentially. The module provides diagnostic information about the present operating conditions. The transceiver generates this diagnostic data by digitization of internal analog signals. Calibration and alarm/warning threshold data is written during device manufacture. Received power monitoring, transmitted power monitoring, bias current monitoring, supply voltage monitoring, and temperature monitoring all are implemented. If the module is defined as external calibrated, the diagnostic data are raw A/D values and must be converted to real world units using calibration constants stored in EEPROM locations 56 – 95 at wire serial bus address A2h. The Digital Diagnostic memory-map specific data field define as following. For detailed EEPROM information, please refer to the related document of SFF8472 Rev 10.2.

2 wire address 1010000X(A0h)

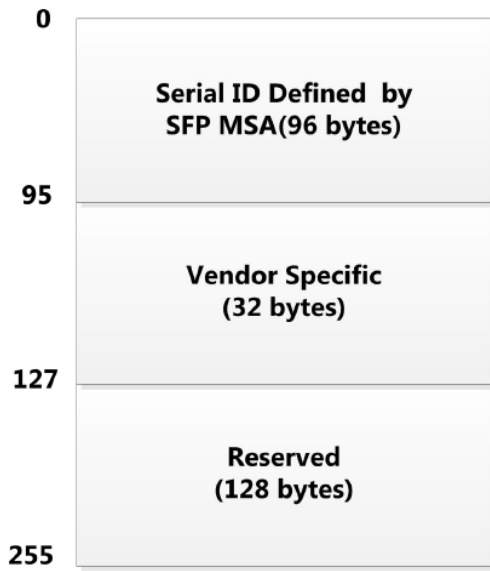

2 wire address 1010000X (A2h)

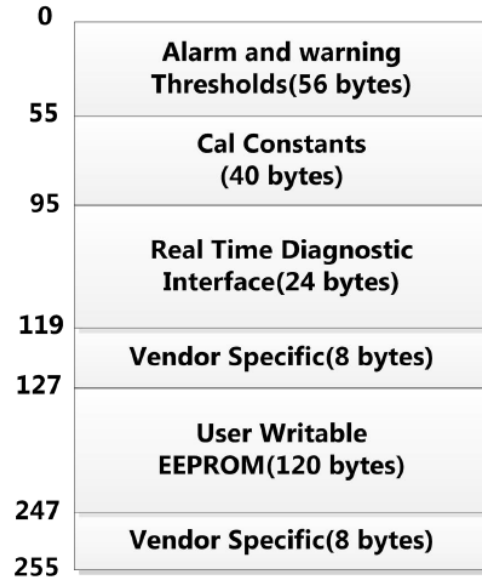

Mechanical Specifications

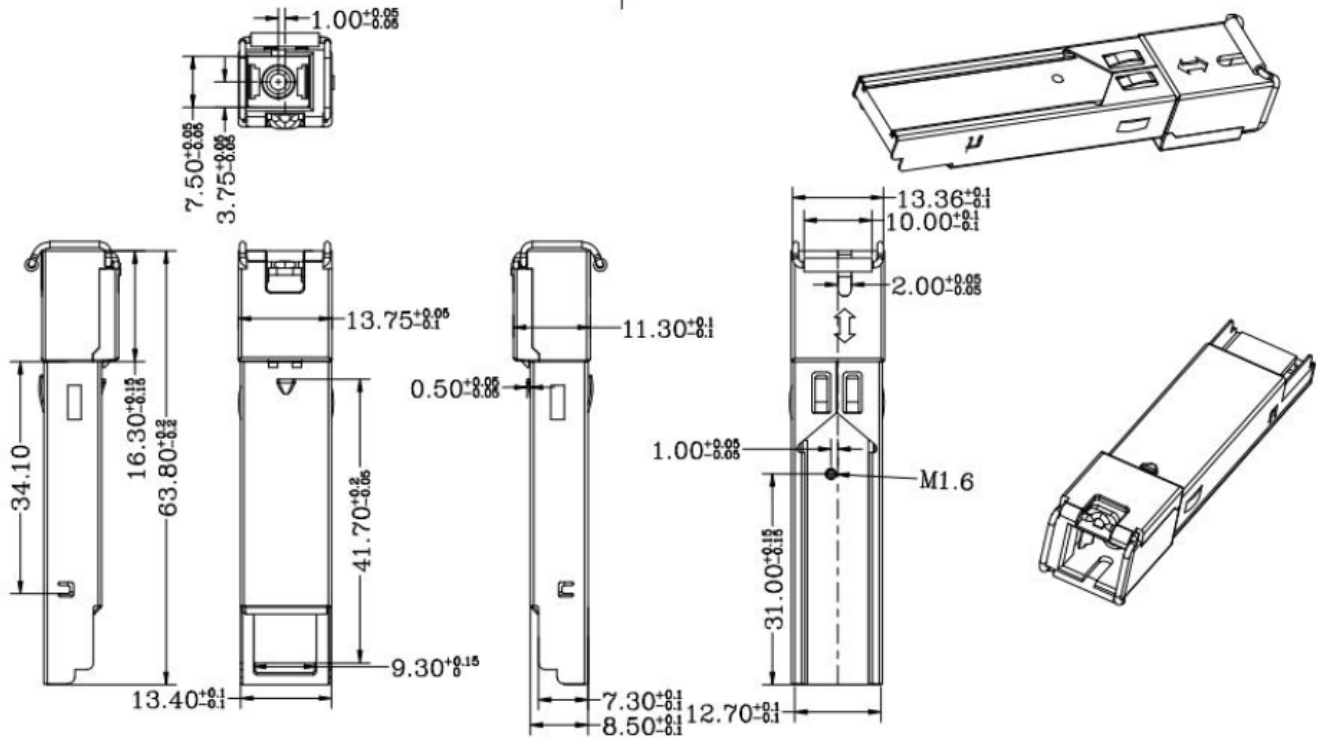

About ProLabs

Our experience comes as standard; for over 15 years ProLabs has delivered optical connectivity solutions that give our customers freedom and choice through our ability to provide seamless interoperability. At the heart of our company is the ability to provide state-of-the-art optical transport and connectivity solutions that are compatible with over 90 optical switching and transport platforms.

Complete Portfolio of Network Solutions

ProLabs is focused on innovations in optical transport and connectivity. The combination of our knowledge of optics and networking equipment enables ProLabs to be your single source for optical transport and connectivity solutions from 100Mb to 400G while providing innovative solutions that increase network efficiency. We provide the optical connectivity expertise that is compatible with and enhances your switching and transport equipment.

Trusted Partner

Customer service is our number one value. ProLabs has invested in people, labs and manufacturing capacity to ensure that you get immediate answers to your questions and compatible product when needed. With Engineering and Manufacturing offices in the U.K. and U.S. augmented by field offices throughout the U.S., U.K. and Asia, ProLabs is able to be our customers best advocate 24 hours a day.



Contact Information

ProLabs US

Email: sales@prolabs.com

Telephone: 952-852-0252

ProLabs UK

Email: salessupport@prolabs.com

Telephone: +44 1285 719 600