

42844-1 ✓ ACTIVE

FASTON | FASTON 250

TE Internal #: 42844-1

Quick Disconnects, Receptacle, 14 – 12 AWG Wire Size, 2 – 3 mm²

Wire Size, 4107 – 6530 CMA Wire Size, Mating Tab Width 6.35 mm [.

25 in], FASTON 250

[View on TE.com >](#)



Terminals & Splices > Quick Disconnects

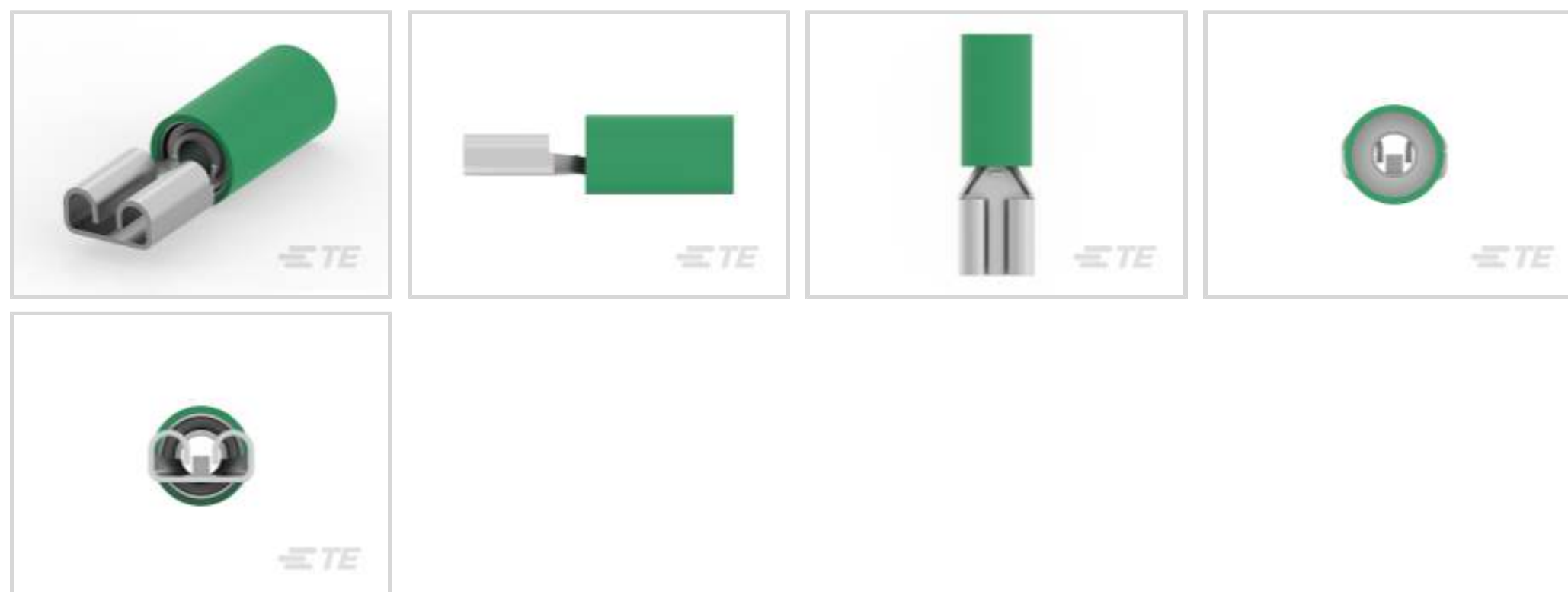

Quick Disconnect Terminal Type: **Receptacle**

Wire Size: **4107 – 6530 CMA**

Mating Tab Width: **6.35 mm [.25 in]**

Features

Product Type Features

Terminal Features Wire Stop

Insertion Force Normal

Configuration Features

Connection Capacity Single

Electrical Characteristics

Voltage Rating 300 V

Body Features

Insulation Material Nylon

Contact Features

Quick Disconnect Terminal Type Receptacle

Mating Tab Width 6.35 mm [.25 in]

Mating Tab Thickness .81 mm [.032 in]

Terminal Orientation Straight

Contact Base Material Brass

Terminal Plating Material Tin



Crimp Type	Compression
------------	-------------

Barrel Type	Closed
-------------	--------

Termination Features

Product Terminates To	Wire & Cable
-----------------------	--------------

Mechanical Attachment

Wire Insulation Support	With
-------------------------	------

Mating Retention Type	Dimple
-----------------------	--------

Dimensions

Terminal Material Thickness	.46 mm[.018 in]
-----------------------------	-----------------

Product Length	25.7 mm[1.012 in]
----------------	-------------------

Compatible Insulation Diameter Range	6.35 mm[.25 in]
--------------------------------------	-----------------

Wire Size	4107 – 6530 CMA
-----------	-----------------

Usage Conditions

Insulation Option	Partially Insulated
-------------------	---------------------

Operating Temperature Range	105 °C[221 °F]
-----------------------------	----------------

Packaging Features

Packaging Quantity	500
--------------------	-----

Packaging Method	Loose Piece
------------------	-------------

Other

Barrel Color	Green
--------------	-------

Product Compliance

[For compliance documentation, visit the product page on TE.com>](#)

EU RoHS Directive 2011/65/EU	Compliant
------------------------------	-----------

EU ELV Directive 2000/53/EC	Compliant
-----------------------------	-----------

China RoHS 2 Directive MIIT Order No 32, 2016	No Restricted Materials Above Threshold
---	---

EU REACH Regulation (EC) No. 1907/2006	Current ECHA Candidate List: JUNE 2023 (235) Candidate List Declared Against: JUNE 2023 (235) Does not contain REACH SVHC
--	---

Halogen Content	Low Halogen - Br, Cl, F, I < 900 ppm per homogenous material. Also BFR/CFR/PVC Free
-----------------	---









Solder Process Capability

Not applicable for solder process capability

Product Compliance Disclaimer

This information is provided based on reasonable inquiry of our suppliers and represents our current actual knowledge based on the information they provided. This information is subject to change. The part numbers that TE has identified as EU RoHS compliant have a maximum concentration of 0.1% by weight in homogenous materials for lead, hexavalent chromium, mercury, PBB, PBDE, DBP, BBP, DEHP, DIBP, and 0.01% for cadmium, or qualify for an exemption to these limits as defined in the Annexes of Directive 2011/65/EU (RoHS2). Finished electrical and electronic equipment products will be CE marked as required by Directive 2011/65/EU. Components may not be CE marked. Additionally, the part numbers that TE has identified as EU ELV compliant have a maximum concentration of 0.1% by weight in homogenous materials for lead, hexavalent chromium, and mercury, and 0.01% for cadmium, or qualify for an exemption to these limits as defined in the Annexes of Directive 2000/53/EC (ELV). Regarding the REACH Regulation, the information TE provides on SVHC in articles for this part number is based on the latest European Chemicals Agency (ECHA) 'Guidance on requirements for substances in articles' posted at this URL: <https://echa.europa.eu/guidance-documents/guidance-on-reach>

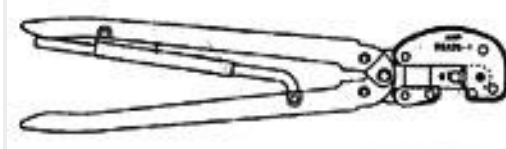
Compatible Parts

 <p>TE Part # 2323802-2 SSRMP-240D16 = Mini Puck,16A,240V AC</p>	 <p>TE Part # 2323802-8 SSRMP-240D16R = Mini Puck,16A,240V AC,R</p>	 <p>TE Part # 2323802-1 SSRMP-240D25 = Mini Puck,25A,240V AC</p>	 <p>TE Part # 2323802-5 SSRMP-480D16 = Mini Puck,16A,480V AC</p>
 <p>TE Part # 1-2323802-2 SSRMP-480D16R = Mini Puck,16A,480V AC,R</p>	 <p>TE Part # 2323802-4 SSRMP-480D25 = Mini Puck,25A,480V AC</p>	 <p>TE Part # 90246-1 HHHT PIDG FASTON 14-12 ASSY</p>	 <p>TE Part # 2323802-7 SSRMP-240D25R = Mini Puck,25A,240V AC,R</p>
 <p>TE Part # 1-2323802-1 SSRMP SERES,Mini Puk,25A,480VAC,R-DC I/P</p>			

Also in the Series | **FASTON 250**



Compression Connectors(4)



Crimp Terminal Housings(142)



Insertion & Extraction Tools(6)



Magnet Wire Terminals(1)



PCB Terminals(135)



Quick Disconnects(445)



Splices(4)

Customers Also Bought



TE Part #353716-2
DYNAMIC D-3 TAB CONT. 3L AU 0.38



TE Part #6609048-6
6EQ3=F7263 S0



TE Part #8-34541-1
PIDG SPD 22-16COMM 22-18MIL 6



TE Part #2213600-7
COOLSPICE LW 12/14 TO 12/14
AWG, SEAL



TE Part #205560-2
AMPLIMITE,ASY,PLUG,STD,109,3

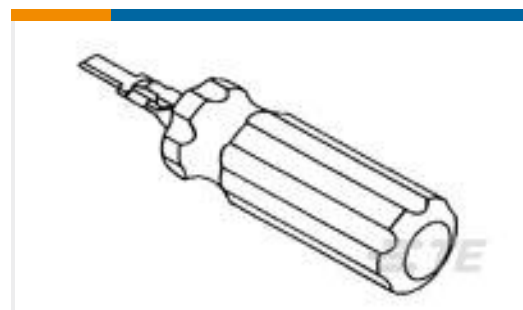

TE Part #234168-1
EXTRACTION TOOL(DYNAMIC D-3)



TE Part #2022103-1
RT17017



TE Part #205165-1
RECEPT ASSY,25 POSN,AMPLIMITE



TE Part #776471-000
CWT-3809-W2

Documents



Product Drawings

RECEPT,PIDG FASTON 14-12 250

English

CAD Files

3D PDF

3D

Customer View Model

[ENG_CVM_CVM_42844-1_AU.2d_dxf.zip](#)

English

Customer View Model

[ENG_CVM_CVM_42844-1_AU.3d_igs.zip](#)

English

Customer View Model

[ENG_CVM_CVM_42844-1_AU.3d_stp.zip](#)

English

Customer View Model

[ENG_CVM_42844-1_Z.2d_dxf.zip](#)

English

Customer View Model

[ENG_CVM_42844-1_Z.3d_igs.zip](#)

English

Customer View Model

[ENG_CVM_42844-1_Z.3d_stp.zip](#)

English

3D PDF

English

By downloading the CAD file I accept and agree to the [Terms and Conditions](#) of use.

Datasheets & Catalog Pages

PIDG_FASTON

English

Ultra-Fast and Ultra Fast Plus

English

Product Specifications

Application Specification

English

Product Environmental Compliance

[MD_42844-1_041820182314_dmtec](#)

English

[MD_42844-1_041820182314_dmtec](#)

English

Agency Approvals



[CSA Certificate](#)

English

[CSA Certificate](#)

English

[CSA Certificate](#)

English