



AMP-METRIMATE

TE Internal #: 390113-1

SO DIMM Sockets, Small Outline (SO), Stack Height .205 in [5.2 mm], Right Angle Module Orientation, 144 Position, AMP-METRIMATE

[View on TE.com >](#)

Connectors > Socket Connectors > Memory Sockets > SO DIMM Sockets > DDR3 SO DIMM Sockets

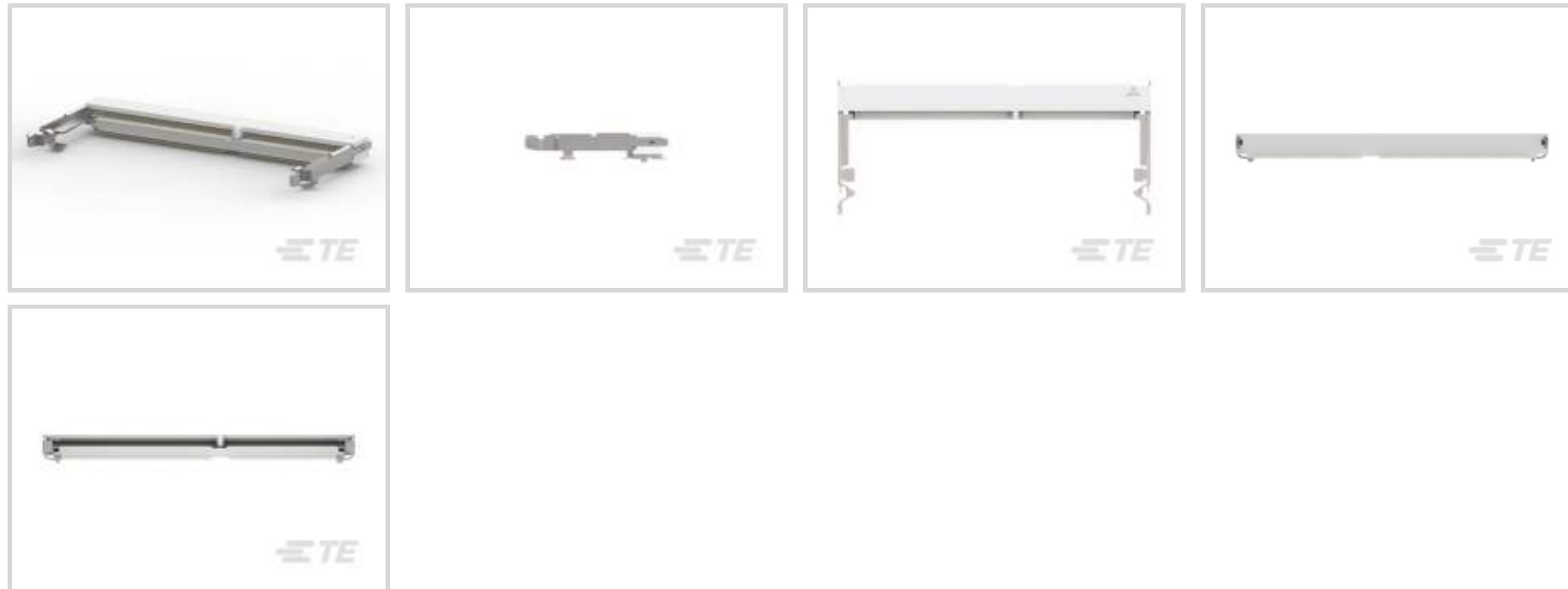

DRAM Type: **Small Outline (SO)**

Stack Height: **5.2 mm [.205 in]**

Module Orientation: **Right Angle**

Connector System: **Cable-to-Board**

Number of Positions: **144**

[All DDR3 SO DIMM Sockets \(13\)](#)

Features

Product Type Features

DRAM Type	Small Outline (SO)
Connector System	Cable-to-Board
Connector & Contact Terminates To	Printed Circuit Board

Configuration Features

Number of Bays	2
Number of Keys	1
Number of Rows	2
Module Orientation	Right Angle
Number of Positions	144

Electrical Characteristics

DRAM Voltage	3.3 V
--------------	-------

Body Features



Ejector Location	None
Latch Material	Stainless Steel
Latch Plating Material	Tin
Module Key Type	SDRAM
Connector Profile	Standard

Contact Features

Memory Socket Type	Memory Card
PCB Contact Termination Area Plating Material	Gold Flash
Contact Base Material	Copper Alloy
Contact Mating Area Plating Material	Gold
Contact Mating Area Plating Material Thickness	.25 μm [9.84 μin]

Termination Features

Insertion Style	Cam-In
-----------------	--------

Mechanical Attachment

Mating Alignment Type	Offset Left
PCB Mounting Style	Surface Mount
PCB Mount Retention	With
PCB Mount Retention Type	Hold-Down Post
Connector Mounting Type	Board Mount

Housing Features

Housing Material	High Temperature Plastic
Housing Color	Natural
Centerline (Pitch)	.8 mm[.031 in]

Dimensions

Stack Height	5.2 mm[.205 in]
Row-to-Row Spacing	6.2 mm[.244 in]

Usage Conditions

Operating Temperature Range	-55 – 105 $^{\circ}\text{C}$ [-67 – 221 $^{\circ}\text{F}$]
-----------------------------	--

Operation/Application

Circuit Application	Signal
---------------------	--------

Industry Standards

UL Flammability Rating	UL 94V-0
------------------------	----------

Packaging Features

Packaging Quantity	20
Packaging Method	Soft Tray

Product Compliance

[For compliance documentation, visit the product page on TE.com>](#)

EU RoHS Directive 2011/65/EU	Compliant
EU ELV Directive 2000/53/EC	Compliant
China RoHS 2 Directive MIIT Order No 32, 2016	No Restricted Materials Above Threshold
EU REACH Regulation (EC) No. 1907/2006	Current ECHA Candidate List: JUNE 2023 (235) Candidate List Declared Against: JAN 2023 (233) Does not contain REACH SVHC
Halogen Content	Low Halogen - Br, Cl, F, I < 900 ppm per homogenous material. Also BFR/CFR/PVC Free
Solder Process Capability	Reflow solder capable to 260°C

Product Compliance Disclaimer

This information is provided based on reasonable inquiry of our suppliers and represents our current actual knowledge based on the information they provided. This information is subject to change. The part numbers that TE has identified as EU RoHS compliant have a maximum concentration of 0.1% by weight in homogenous materials for lead, hexavalent chromium, mercury, PBB, PBDE, DBP, BBP, DEHP, DIBP, and 0.01% for cadmium, or qualify for an exemption to these limits as defined in the Annexes of Directive 2011/65/EU (RoHS2). Finished electrical and electronic equipment products will be CE marked as required by Directive 2011/65/EU. Components may not be CE marked. Additionally, the part numbers that TE has identified as EU ELV compliant have a maximum concentration of 0.1% by weight in homogenous materials for lead, hexavalent chromium, and mercury, and 0.01% for cadmium, or qualify for an exemption to these limits as defined in the Annexes of Directive 2000/53/EC (ELV). Regarding the REACH Regulation, the information TE provides on SVHC in articles for this part number is based on the latest European Chemicals Agency (ECHA) 'Guidance on requirements for substances in articles' posted at this URL: <https://echa.europa.eu/guidance-documents/guidance-on-reach>

Compatible Parts





Also in the Series | AMP-METRIMATE

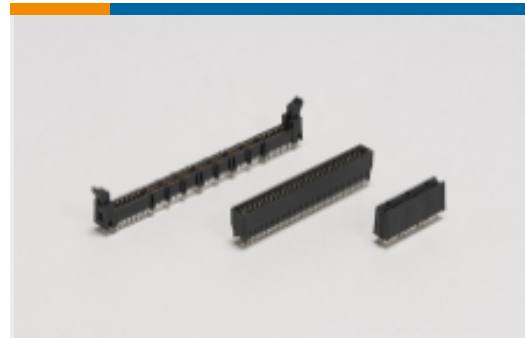

Card Edge Power Connectors(1)

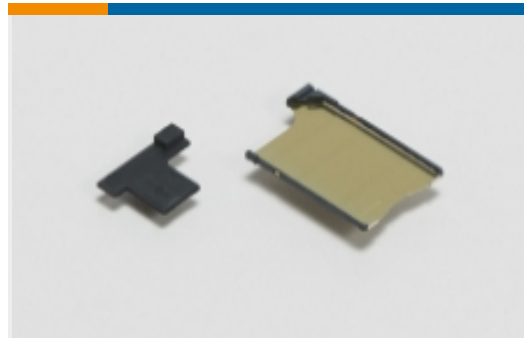

Card Guide Hardware(1)

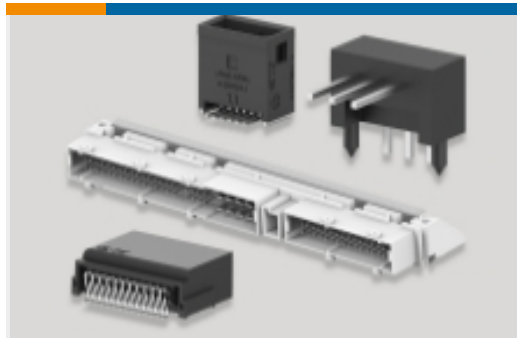

PCB Headers & Receptacles(3)



Rack & Panel Connectors(1)



Rectangular Power Connectors(9)



RJ45 Connectors(50)



SO DIMM Sockets(13)

Customers Also Bought



TE Part #5747150-8
09 RCPT SP/FMS INSRT

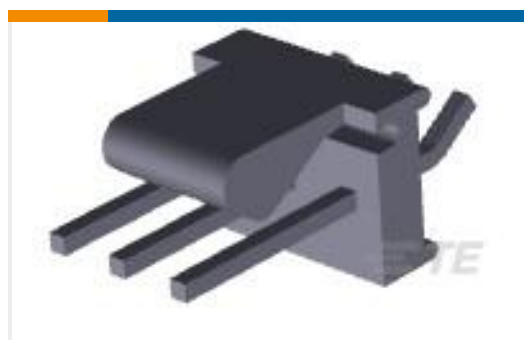

TE Part #644874-3
03P MTA100 HDR ASSY,SPCL BEND

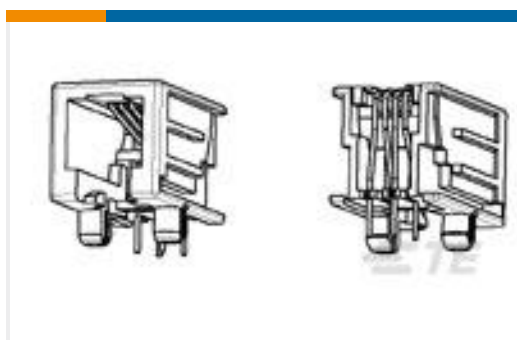

TE Part #1-1705950-2
Modular Jack SE, 6/4, Gold flash



TE Part #1469265-2
UPM R/A KEYED GUIDE PIN



TE Part #4-1624112-8
3650 0402 22nH 5% 2K RL



TE Part #292448-1
3.0mm PITCH 3P SMT ASSEMBLY
BATTERY CONN

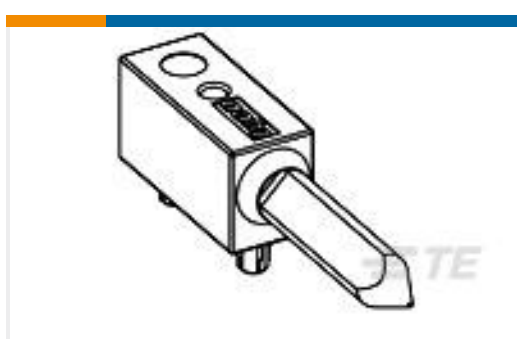

TE Part #1469265-3
UPM R/A KEYED GUIDE PIN



TE Part #6-1624108-3
3640 0402 7.2nH +/-0.2nH 1K RL

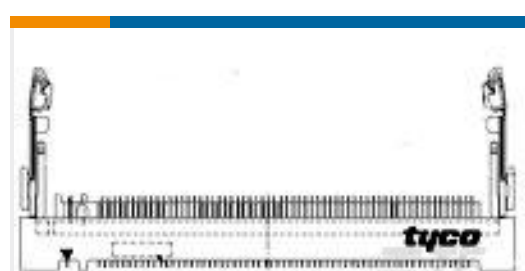

TE Part #440360-2
.8MM FAX MODEM SOCKET 124P,
7.95H



Documents

Product Drawings

[SKT,SODIMM,144P,SDRAM3.3V,STD,TY-S](#)

English

CAD Files

[3D PDF](#)

English

Customer View Model

[ENG_CVM_390113-1_H.2d_dxf.zip](#)

English

Customer View Model

[ENG_CVM_390113-1_H.3d_igs.zip](#)

English

Customer View Model

[ENG_CVM_390113-1_H.3d_stp.zip](#)

English

By downloading the CAD file I accept and agree to the [Terms and Conditions](#) of use.

Product Specifications

[Application Specification](#)

English

Agency Approvals

[Agency Approval Document](#)

English