

IS31LT3952_IS32LT3952 DEMO BOARD GUIDE

DESCRIPTION

The IS31LT3952_IS32LT3952 is a DC-to-DC switching converter, which integrate an N-channel MOSFET to operate in a buck configuration. The device supply a wide input voltage between 4.5V and 38V and provides a constant current of up to 1.5A for driving a single LED or multiple series connected LEDs.

The external resistor, R_{SET} , is used to adjust LED output current, which allowing the output voltage to be automatically adjusted for a variety of LED configurations.

The IS31LT3952_IS32LT3952 operates in a fixed frequency mode during switching. There is an external resistor connected between the VCC and TON pins used to configure the on-time (switching frequency). The switching frequency is dithered for spread spectrum feature to spread the electromagnetic emitting energy into a wider frequency band. It is helpful to optimize the EMI performance.

A logic input PWM signal to the enable (EN) pin is applied to adjust the LED current. The brightness of LED is proportional to the duty cycle of the PWM signal.

True average output current operation is achieved with fast transient response by using cycle-by-cycle, controlled on-time method.

IS31LT3952_IS32LT3952 is available in an SOP-8-EP package with an exposed pad for enhanced thermal dissipation. It operates from 4.5V to 38V over the temperature range of -40°C to $+125^{\circ}\text{C}$.

FEATURES

- Wide input voltage supply from 4.5V to 38V
 - Withstand 40V load dump
- $\pm 5\%$ true average output current control
- 1.5A maximum output over operating temperature range
- Cycle-by-cycle current limit
- Integrated high-side MOSFET switch
- Dimming via direct logic input or power supply voltage
- Internal control loop compensation
- Under-voltage lockout (UVLO) and thermal shutdown protection
- $2\mu\text{A}$ low power shutdown
- Spread spectrum to optimize EMI
- Robust fault protection:
 - Pin-to-GND short
 - Component open/short faults
 - Adjacent pin-to-pin short
 - LED open/short
- AEC-Q100 qualification
 - IS32LT3952 only

QUICK START



Figure 1: Photo of IS31LT3952_IS32LT3952 Evaluation Board

RECOMMENDED EQUIPMENT

- 38VDC power supply
- 1 pcs of LED panel (3W LEDs, 2LEDs in parallel and then 10 LEDs in series on each panel)
- Multi-meter

RECOMMENDED INPUT AND OUTPUT RATINGS

- Input: 4.5~38VDC
- Output: 1~10 LEDs in series/1.5A

ABSOLUTE MAXIMUM RATINGS

- Input voltage $\leq 42\text{VDC}$

Caution: Do not exceed the conditions listed above, otherwise the board will be damaged.

PROCEDURE

The IS31LT3952_IS32LT3952 DEMO Board is fully assembled and tested. Follow the steps listed below to verify board operation.

Caution: Do not turn on the power supply until all connections are completed.

- 1) Connect the positive terminal of the power supply to the VCC of the board and the negative terminal of the power supply to the GND of the board.
- 2) Connect the negative of the LED panel (LED arrays) to the LED- terminal. And connect the positive of the LED panel (LED arrays) to the LED+ terminal.
- 3) Select R_{SET} register on the DEMO Board by JP1~JP4 to set output current, that $I_{OUT}=0.2/R_{SET}$.
- 4) Select EN/PWM pin to VCC by JP5 or connect to a PWM signal generator. Note: when connect to the PWM signal, the JP5 must be open to avoid PWM generator damage.
- 5) Turn on the power supply and the LED panels (LED arrays) will be lighted up.

ORDER INFORMATION

| Part No. | Temperature Range | Package |
|---------------------|------------------------------|---------------------|
| IS31LT3952-GRLS4-EB | -40°C to +125°C (Industrial) | SOP-8-EP, Lead-free |
| IS32LT3952-GRLA3-EB | -40°C to +125°C (Automotive) | |

For pricing, delivery, and ordering information, please contact Lumissil's analog marketing team at analog@lumissil.com or (408) 969-6600.

DETAILED DESCRIPTION

OUTPUT CURRENT SETTING

The LED current is configured by an external sense resistor, R_{SET} , with a value determined as follows Equation (1):

$$I_{LED} = V_{FB} / R_{SET} \quad (1)$$

Where $V_{FB} = 0.2V$ (Typ.).

Note that $R_{SET} = 0.133\Omega$ is the minimum allowed value of sense resistor to maintain switch current below the specified maximum value.

Table 1 R_{SET} Resistance Versus Output Current

| R_{SET} (Ω) | Nominal Average Output Current (mA) |
|------------------------|-------------------------------------|
| 0.4 | 500 |
| 0.2 | 1000 |
| 0.133 | 1500 |

The R_{SET} should be a 1% resistor with enough power tolerance and good temperature characteristic to ensure accurate and stable output current.

FREQUENCY SELECTION

During switching the IS31LT3952_IS32LT3952 operates in a consistent on-time mode. The on-time is adjusted by an external resistor, R_{TON} , which is connected between the VCC and TON pins.

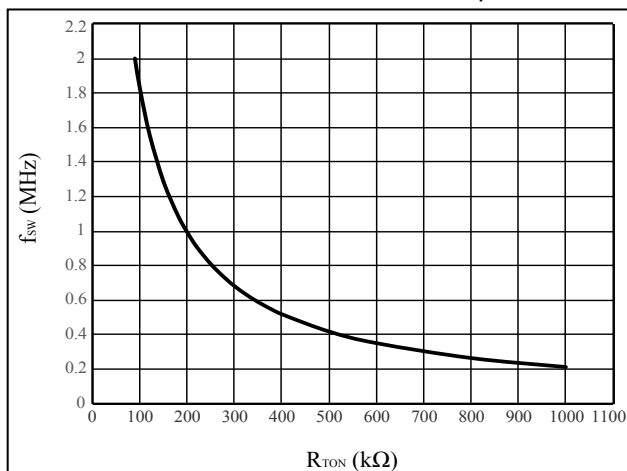

Figure 2: Operating Frequency vs. R_{TON} Resistance

The approximate operating frequency can be

calculated by below Equation (2) and (3):

$$t_{ON} = \frac{k \times (R_{TON} + R_{INT}) \times V_{OUT}}{V_{CC}} \quad (2)$$

$$f_{SW} = \frac{1}{k \times (R_{TON} + R_{INT})} \quad (3)$$

Where $k = 0.00458$, with f_{SW} in MHz, t_{ON} in μs , and R_{TON} and R_{INT} (internal resistance, 20k Ω) in k Ω .

Higher frequency gets smaller components size but increases the switching losses and high-side MOSFET gate driving current, and may not allow sufficiently high or low duty cycle. Lower frequency gives better performance at larger components size.

INDUCTOR

Inductor value involves trade-offs in performance. Larger inductance reduces inductor current ripple that obtains smaller output current ripple, however it also brings in unwanted parasitic resistance that degrade the performance. Smaller inductance has compact size and lower cost, but introduces higher ripple in the LED string. Use the following equations to estimate the approximate inductor value:

$$L = \frac{(V_{CC} - V_{LED}) \times V_{LED}}{f_{SW} \times \Delta I_L \times V_{CC}} \quad (4)$$

Where V_{CC} uses the minimum input voltage in volts, V_{LED} is the total forward voltage of LED string in volts, f_{SW} is the operation frequency in hertz. ΔI_L is the current ripple in the inductor. Select an inductor with a rating current over output average current and the saturation current over the Over Current Protection (OCP) current threshold I_{SWLIM} .

Since IS31LT3952_IS32LT3952 is a Continuous Conduction Mode (CCM) buck driver which means the valley of the inductor current, I_{MIN} , should not drop to zero all the time, the ΔI_L must be smaller than 200% of the average output current.

$$I_{MIN} = I_{LED} - \frac{\Delta I_L}{2} > 0 \quad (5)$$

Besides, the peak current of the inductor, I_{MAX} , must be smaller than I_{SWLIM} to prevent device from triggering

OCP, especially the output current is set to high level.

$$I_{MAX} = I_{LED} + \frac{\Delta I_L}{2} < I_{SWLIM} \quad (6)$$

On the other hand, the ΔI_L has to be higher than 10% of the average output current all the time to ensure the system stability. For the better performance, recommend to choose the inductor current ripple ΔI_L between 10% and 50% of the average output current.

$$0.1 \times I_{LED} \leq \Delta I_L \leq 0.5 \times I_{LED} \quad (7)$$

Below figure shows the inductance selection based on operating frequency and LED current at 30% inductor current ripple. If the lower operating frequency is adopted, either the larger inductance or current ripple should be used.

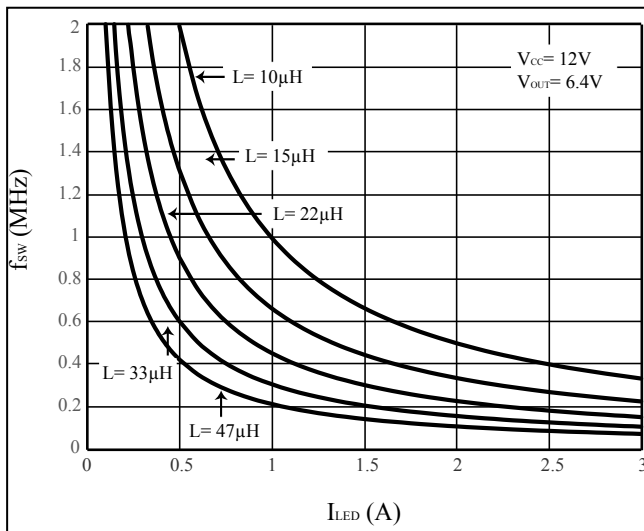

Figure 3: Inductance Selection Based On 30% Current Ripple

Note: The Würth Elektronik WE-PD 744770xxx and 744771xxx series are the suitable inductance value choice.

FAULT HANDLING

The IS31LT3952_IS32LT3952 is designed to detect the following faults:

- Pin open
- Pin-to-ground short
- Pin-to-neighboring pin short
- Output LED string open and short
- External component open or short

Please check Table 2 for the detail of the fault actions.

PCB LAYOUT CONSIDERATION

As for all switching power supplies, especially those providing high current and using high switching frequencies, layout is an important design step. If layout is not carefully done, the operation could show instability as well as EMI problems.

The high dV/dt surface and dI/dt loops are big noise emission source. To optimize the EMI performance, keep the area size of all high switching frequency points with high voltage compact. Meantime, keep all traces carrying high current as short as possible to minimize the loops.

(1) Wide traces should be used for connection of the high current paths that helps to achieve better efficiency and EMI performance. Such as the traces of power supply, inductor L_1 , current recirculating diode D_1 , LED load and ground.

(2) Keep the traces of the switching points shorter. The inductor L_1 , LX and current recirculating diode D_1 should be placed as close to each other as possible and the traces of connection between them should be as short and wide as possible.

(3) To avoid the ground jitter, the components of parameter setting, R_{SET} , should be placed close to the device and keep the traces length to the device pins as short as possible. On the other side, to prevent the noise coupling, the traces of R_{SET} should either be far away or be isolated from high-current paths and high-speed switching nodes. These practices are essential for better accuracy and stability.

(4) The capacitor C_{IN} should be placed as close as possible to VCC pin for good filtering.

(5) Place the bootstrap capacitor C_{BOOT} close to BOOT pin and LX pin to ensure the traces as short as possible.

(6) The connection to the LED string should be kept short to minimize radiated emission. In practice, if the LED string is far away from the driver board, an output capacitor is recommended to be used and placed on driver board to reduce the current ripple in the connecting wire.

(7) The thermal pad on the back of device package must be soldered to a sufficient size of copper ground plane with sufficient vias to conduct the heat to opposite side PCB for adequate cooling.

IS31LT3952_IS32LT3952 DEMO BOARD GUIDE

Table 2 Fault Actions

| Fault Type | LED String | Detect Condition | Fault Recovering |
|-----------------------------------|------------|---|--|
| Inductor shorted | Dim | Trigger OCP. Turn off high-side MOSFET immediately. Retry after 1ms. | Inductor shorted removed. No OCP triggered. |
| R _{SET} short | Dim | Trigger OCP. Turn off high-side MOSFET immediately. Retry after 1ms. | R _{SET} shorted removed. No OCP triggered. |
| R _{SET} open | Off | The FB pin voltage exceeds 2V. Turn off high-side MOSFET immediately. Retry after 1ms. | R _{SET} open removed. The FB pin voltage drops below 1.55V. |
| LED string shorted to GND | Off | Trigger OCP. Turn off high-side MOSFET immediately. Retry after 1ms. | Shorted removed. No OCP triggered. |
| BOOT capacitor open | Dim | VCC-V _{sw} >1.8V at high-side MOSFET ON (High-side can't fully turn on). Turn off high-side MOSFET immediately. Retry after 1ms. | BOOT capacitor open removed |
| BOOT capacitor shorted | Off | Bootstrap circuit UVLO and turn off high-side MOSFET immediately. | BOOT capacitor shorted removed. Release from UVLO. |
| R _{TON} resistor open | Dim | On-time exceeds 20μs or trigger OCP, then turn off high-side MOSFET immediately. Retry after 1ms. | R _{TON} resistor open removed. No over 20μs on-time or OCP triggered. |
| R _{TON} resistor shorted | Dim | The device operating at minimum on/off time, maybe trigger the other fault conditions. | R _{TON} resistor shorted removed. |
| EN short to R _{SET} | Off | EN/PWM will be pulled low by R _{SET} resistor. | EN short to R _{SET} removed. |

IS31LT3952_IS32LT3952 DEMO BOARD GUIDE

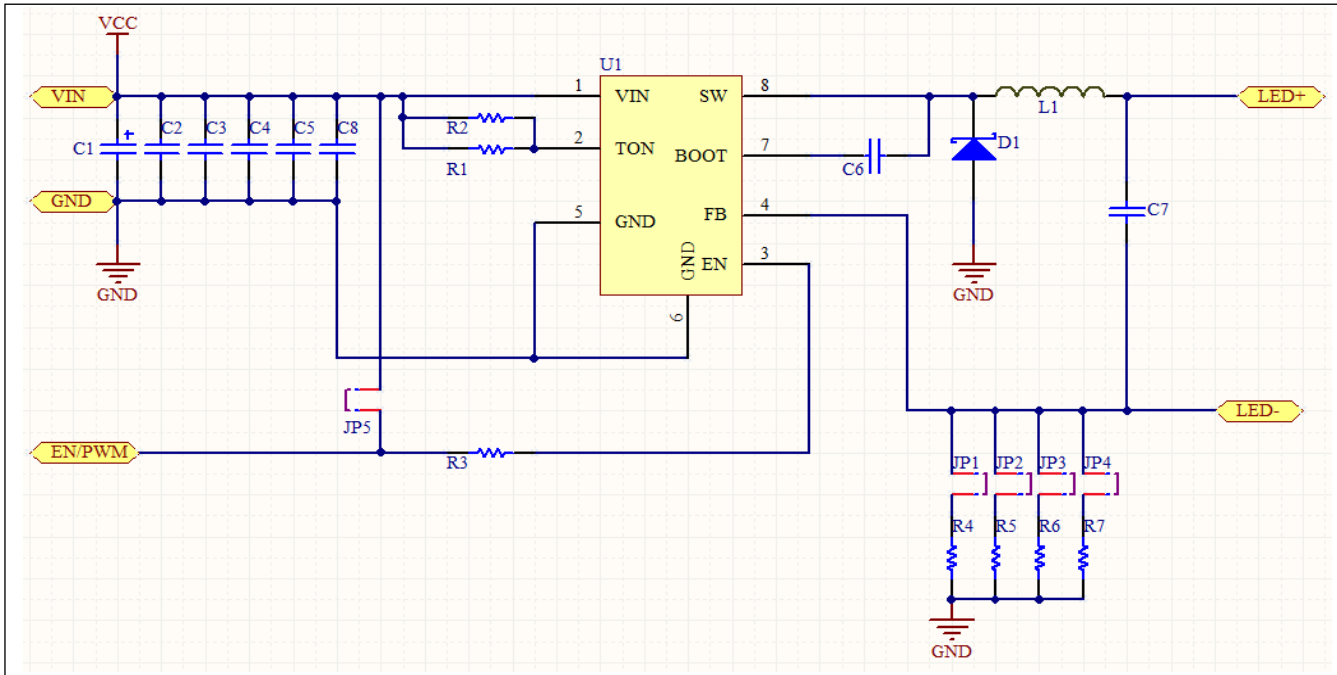

Figure 4: IS31LT3952_IS32LT3952 Demo Board Schematic

BILL OF MATERIALS

| Name | Symbol | Description | Qty | Supplier | Part No. |
|-----------|----------|--|-----|------------------|---|
| IC | U1 | Constant current LED driver | 1 | Lumissil | IS31LT3952-GRLS4-TR/ IS32LT3952-GRLA3-TR |
| E-Cap | C1 | CAP,47 μ F,63V, \pm 20% | 1 | Panasonic | EEV-TG1J470P |
| Capacitor | C2,C3,C7 | NC | | | |
| Capacitor | C4,C5,C8 | CAP,10 μ F,50V, \pm 10%,SMD | 3 | Yageo | AC1206KKX7R9BB106 |
| Capacitor | C6 | CAP,100nF,50V, \pm 10%,SMD | 1 | Yageo | AC0805KKX7R9BB104 |
| Resistor | R1 | RES,430k,1/8W, \pm 5%,SMD | 1 | Yageo | AC0805JR-07430KL |
| Resistor | R3 | RES,1k,1/8W, \pm 5%,SMD | 1 | Yageo | AC0805JR-0701KL |
| Resistor | R4 | RES,0.33R,1/4W, \pm 1%,SMD | 1 | Yageo | RL1206FR-070R33L |
| Resistor | R5 | RES,0.5R,1/4W, \pm 1%,SMD | 1 | Yageo | RL1206FR-070R5L |
| Resistor | R6 | RES,0.62R,1/4W, \pm 1%,SMD | 1 | Yageo | RL1206FR-070R62L |
| Resistor | R7 | RES,0.91R,1/4W, \pm 1%,SMD | 1 | Yageo | RL1206FR-070R91L |
| Resistor | R2 | NC | | | |
| Diode | D1 | 5A,100V, Power DI 5 | 1 | Diodes | PDS5100 |
| Inductor | L1 | 15 μ H \pm 20%,Isat \geq 4.55A,SMD | 1 | Würth Elektronik | 744771115 |

Note: Bill of materials refers to Figure 4 above.

IS31LT3952_IS32LT3952 DEMO BOARD GUIDE

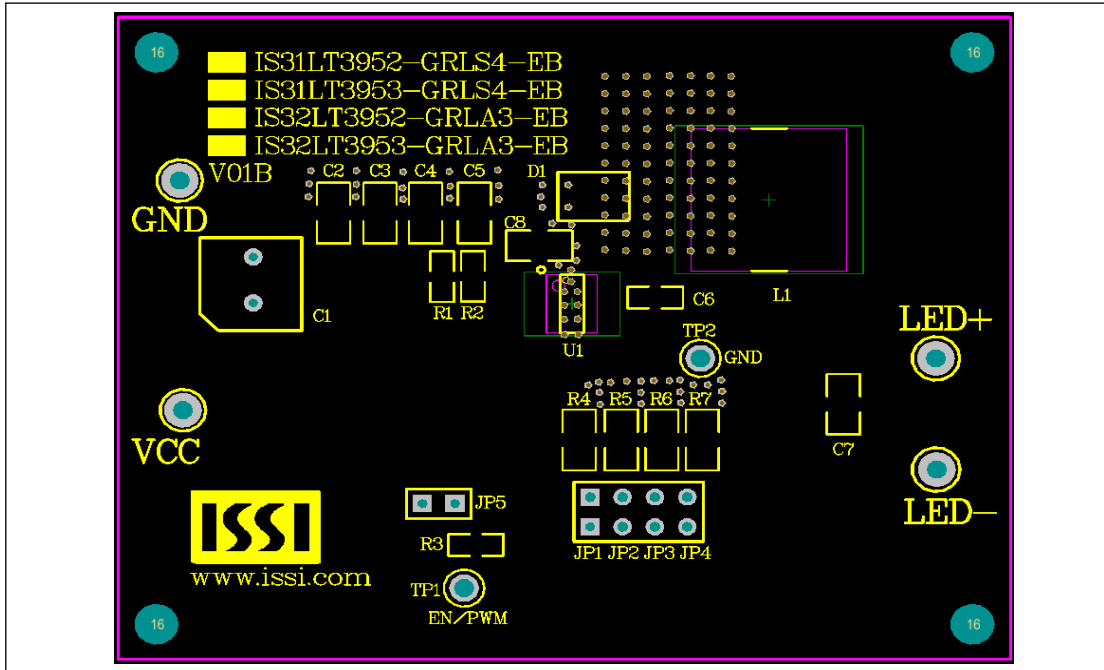

Figure 5: Board Component Placement Guide - Top Layer

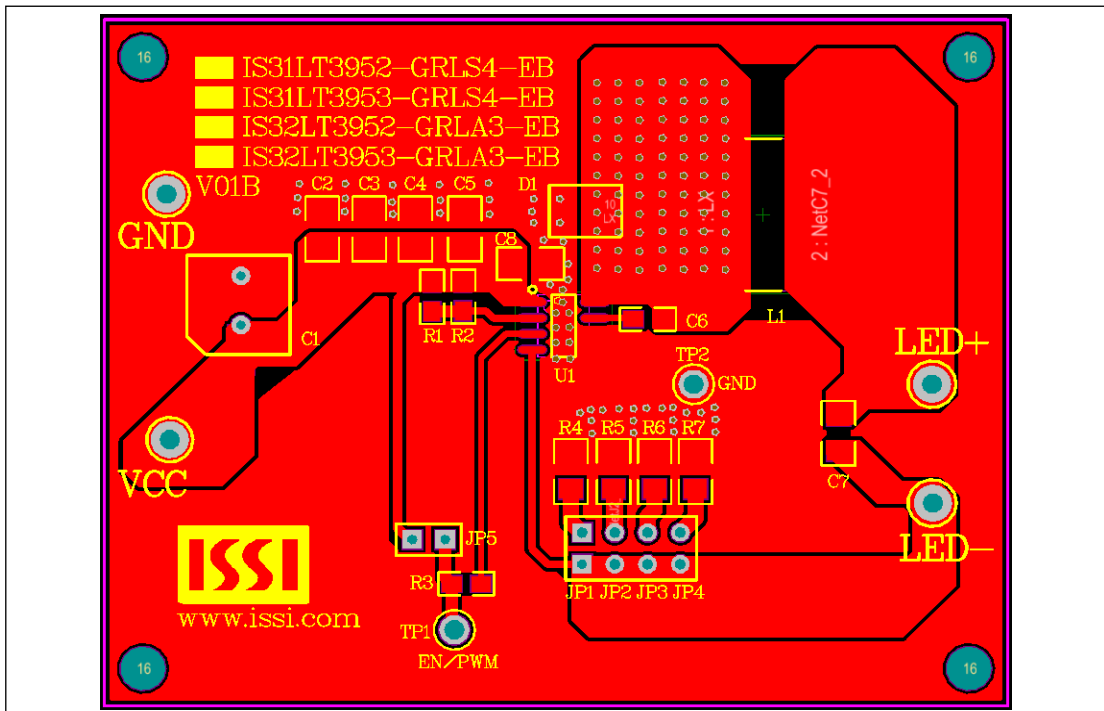

Figure 6: Board PCB Layout - Top Layer

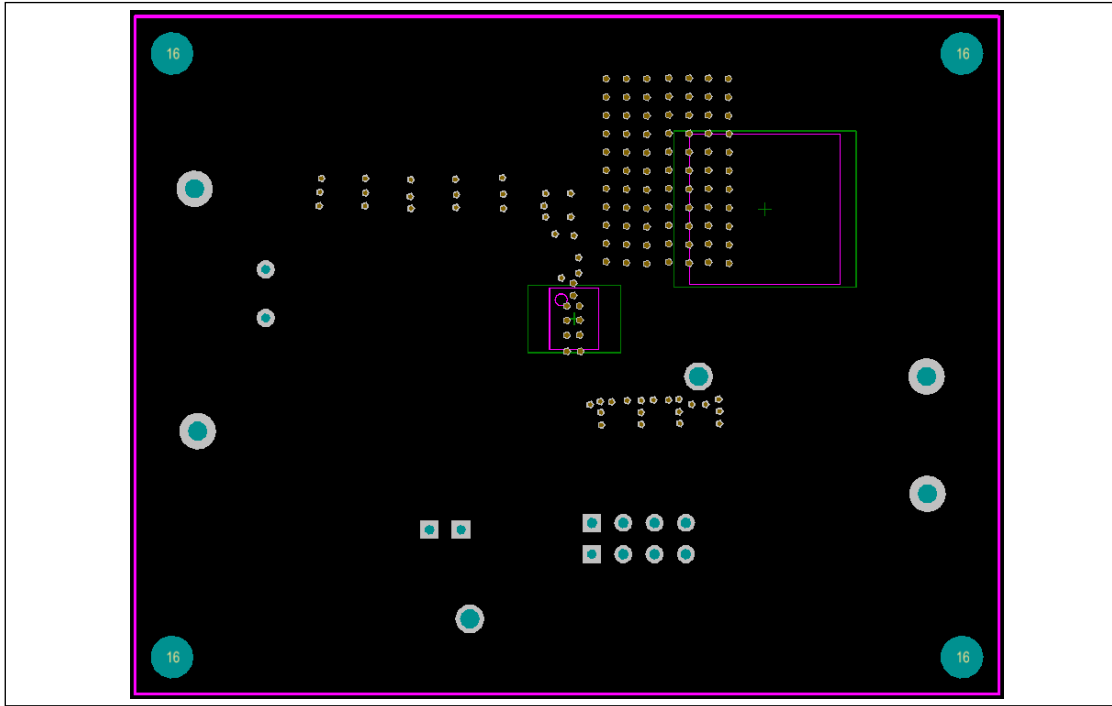

Figure 7: Board Component Placement Guide - Bottom Layer

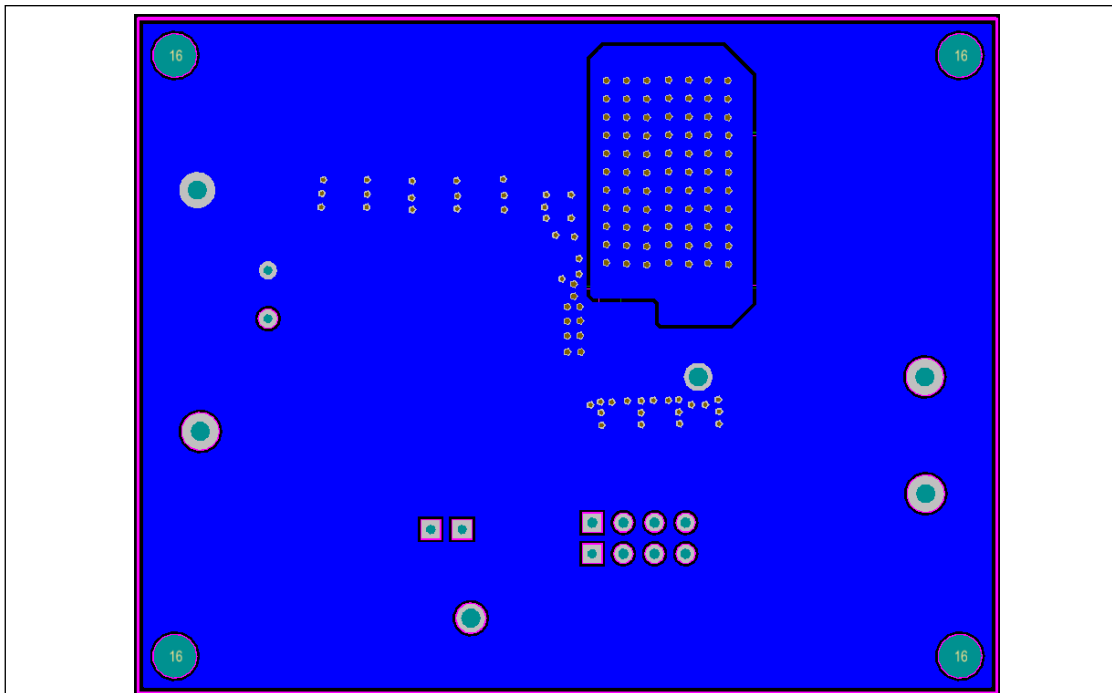

Figure 8: Board PCB Layout - Bottom Layer

Copyright © 2018 Lumissil Microsystems. All rights reserved. Lumissil Microsystems reserves the right to make changes to this specification and its products at any time without notice. Lumissil Microsystems assumes no liability arising out of the application or use of any information, products or services described herein. Customers are advised to obtain the latest version of this device specification before relying on any published information and before placing orders for products.

Lumissil Microsystems does not recommend the use of any of its products in life support applications where the failure or malfunction of the product can reasonably be expected to cause failure of the life support system or to significantly affect its safety or effectiveness. Products are not authorized for use in such applications unless Lumissil Microsystems receives written assurance to its satisfaction, that:

- a.) the risk of injury or damage has been minimized;
- b.) the user assume all such risks; and
- c.) potential liability of Lumissil Microsystems is adequately protected under the circumstances

IS31LT3952_IS32LT3952 DEMO BOARD GUIDE

REVISION HISTORY

| Revision | Detail Information | Date |
|----------|--------------------|------------|
| A | Initial release | 2018.06.25 |