

General Description

The AOK60N30L is fabricated using an advanced high voltage MOSFET process that is designed to deliver high levels of performance and robustness in popular AC-DC applications. By providing low $R_{DS(on)}$, C_{iss} and C_{rss} along with guaranteed avalanche capability this part can be adopted quickly into new and existing offline power supply designs.

Product Summary

V_{DS}	350@150°C
I_D (at $V_{GS}=10V$)	60A
$R_{DS(ON)}$ (at $V_{GS}=10V$)	< 0.056Ω

100% UIS Tested
 100% R_g Tested

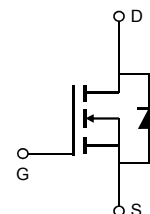
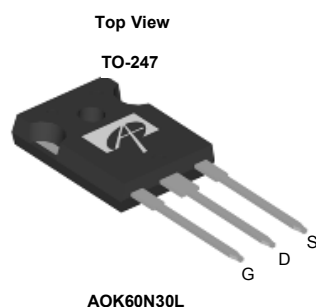

Absolute Maximum Ratings $T_A=25^\circ C$ unless otherwise noted

Parameter	Symbol	AOK60N30L	Units
Drain-Source Voltage	V_{DS}	300	V
Gate-Source Voltage	V_{GS}	±30	V
Continuous Drain Current	I_D	$T_C=25^\circ C$	60
		$T_C=100^\circ C$	40
Pulsed Drain Current ^C	I_{DM}	200	A
Avalanche Current ^C	I_{AR}	9.5	A
Repetitive avalanche energy ^C	E_{AR}	1353	mJ
Single plused avalanche energy ^G	E_{AS}	2707	mJ
Peak diode recovery dv/dt	dv/dt	5	V/ns
Power Dissipation ^B	P_D	$T_C=25^\circ C$	658
		Derate above 25°C	5.3
Junction and Storage Temperature Range	T_J, T_{STG}	-55 to 150	°C
Maximum lead temperature for soldering purpose, 1/8" from case for 5 seconds	T_L	300	°C

Thermal Characteristics

Parameter	Symbol	AOK60N30L	Units
Maximum Junction-to-Ambient ^{A,D}	$R_{\theta JA}$	40	°C/W
Maximum Case-to-sink ^A	$R_{\theta CS}$	0.5	°C/W
Maximum Junction-to-Case	$R_{\theta JC}$	0.19	°C/W

Electrical Characteristics (T_J=25°C unless otherwise noted)

Symbol	Parameter	Conditions	Min	Typ	Max	Units	
STATIC PARAMETERS							
BV _{DSS}	Drain-Source Breakdown Voltage	I _D =250μA, V _{GS} =0V, T _J =25°C	300			V	
		I _D =250μA, V _{GS} =0V, T _J =150°C		350			
BV _{DSS} /ΔT _J	Zero Gate Voltage Drain Current	I _D =250μA, V _{GS} =0V		0.26		V/°C	
I _{DSS}	Zero Gate Voltage Drain Current	V _{DS} =300V, V _{GS} =0V			1	μA	
		V _{DS} =240V, T _J =125°C			10		
I _{GSS}	Gate-Body leakage current	V _{DS} =0V, V _{GS} =±30V			±100	nA	
V _{GS(th)}	Gate Threshold Voltage	V _{DS} =5V, I _D =250μA	2.9	3.5	4.1	V	
R _{DS(ON)}	Static Drain-Source On-Resistance	V _{GS} =10V, I _D =30A		0.042	0.056	Ω	
g _{FS}	Forward Transconductance	V _{DS} =40V, I _D =30A		52		S	
V _{SD}	Diode Forward Voltage	I _S =1A, V _{GS} =0V		0.68	1	V	
I _S	Maximum Body-Diode Continuous Current				60	A	
I _{SM}	Maximum Body-Diode Pulsed Current				200	A	
DYNAMIC PARAMETERS							
C _{iss}	Input Capacitance	V _{GS} =0V, V _{DS} =25V, f=1MHz	3550	4438	5330	pF	
C _{oss}	Output Capacitance		410	593	770	pF	
C _{rss}	Reverse Transfer Capacitance		22	38	54	pF	
R _g	Gate resistance	V _{GS} =0V, V _{DS} =0V, f=1MHz	0.8	1.7	2.6	Ω	
SWITCHING PARAMETERS							
Q _g	Total Gate Charge	V _{GS} =10V, V _{DS} =240V, I _D =60A	70	88	106	nC	
Q _{gs}	Gate Source Charge				21		nC
Q _{gd}	Gate Drain Charge				28		nC
t _{D(on)}	Turn-On Delay Time	V _{GS} =10V, V _{DS} =150V, I _D =60A, R _G =25Ω		88		ns	
t _r	Turn-On Rise Time			222		ns	
t _{D(off)}	Turn-Off Delay Time			224		ns	
t _f	Turn-Off Fall Time			132		ns	
t _{rr}	Body Diode Reverse Recovery Time	I _F =60A, dI/dt=100A/μs, V _{DS} =100V	250	320	390	ns	
Q _{rr}	Body Diode Reverse Recovery Charge	I _F =60A, dI/dt=100A/μs, V _{DS} =100V	11	14.5	18	μC	

A. The value of R_{θJA} is measured with the device in a still air environment with T_A=25°C.

B. The power dissipation P_D is based on T_{J(MAX)}=150°C, using junction-to-case thermal resistance, and is more useful in setting the upper dissipation limit for cases where additional heatsinking is used.

C. Repetitive rating, pulse width limited by junction temperature T_{J(MAX)}=150°C. Ratings are based on low frequency and duty cycles to keep initial T_J=25°C.

D. The R_{θJA} is the sum of the thermal impedance from junction to case R_{θJC} and case to ambient.

E. The static characteristics in Figures 1 to 6 are obtained using <300 μs pulses, duty cycle 0.5% max.

F. These curves are based on the junction-to-case thermal impedance which is measured with the device mounted to a large heatsink, assuming a maximum junction temperature of T_{J(MAX)}=150°C. The SOA curve provides a single pulse rating.

G. L=60mH, I_{AS}=9.5A, V_{DD}=150V, R_G=25Ω, Starting T_J=25°C

APPLICATIONS OR USE AS CRITICAL COMPONENTS IN LIFE SUPPORT DEVICES OR SYSTEMS ARE NOT AUTHORIZED. AOS DOES NOT ASSUME ANY LIABILITY ARISING OUT OF SUCH APPLICATIONS OR USES OF ITS PRODUCTS. AOS RESERVES THE RIGHT TO IMPROVE PRODUCT DESIGN, FUNCTIONS AND RELIABILITY WITHOUT NOTICE.

TYPICAL ELECTRICAL AND THERMAL CHARACTERISTICS

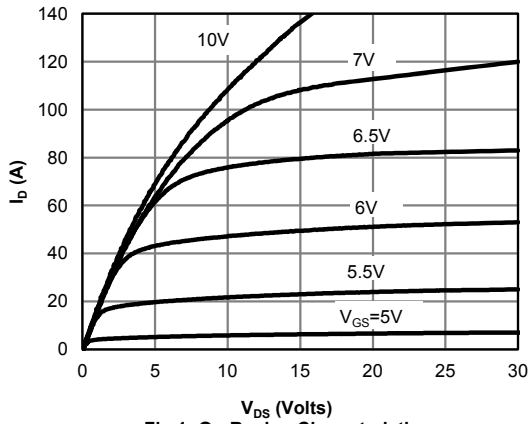

Fig 1: On-Region Characteristics

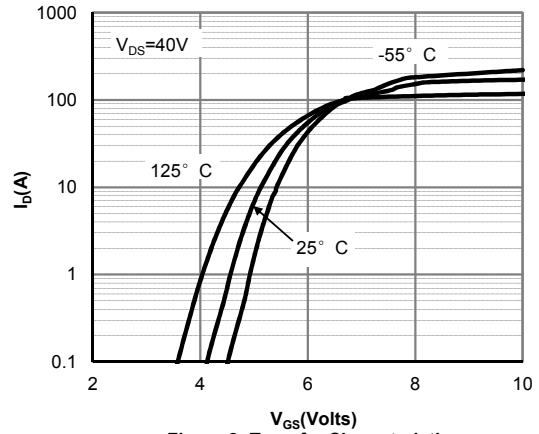

Figure 2: Transfer Characteristics

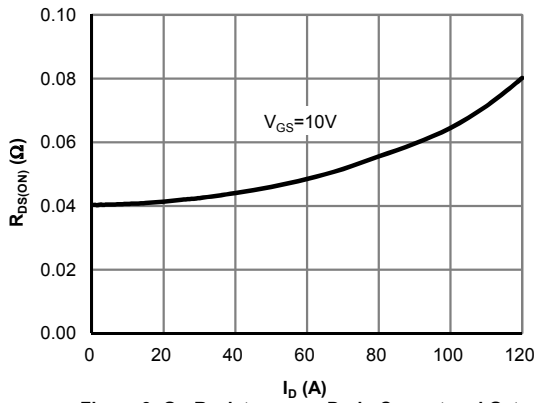

Figure 3: On-Resistance vs. Drain Current and Gate Voltage

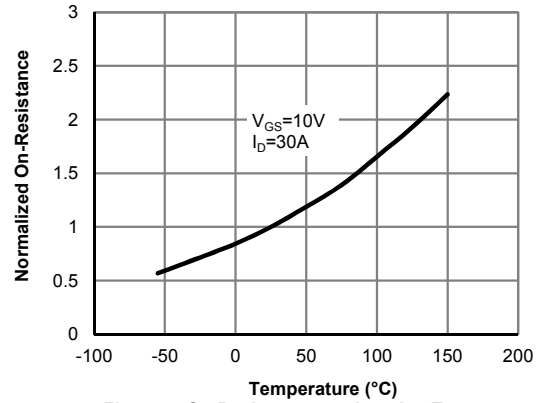

Figure 4: On-Resistance vs. Junction Temperature

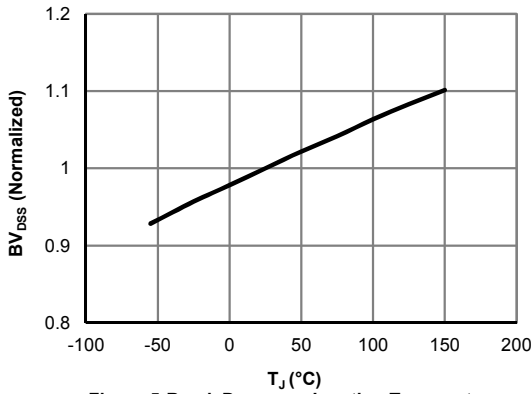

Figure 5: Break Down vs. Junction Temperature

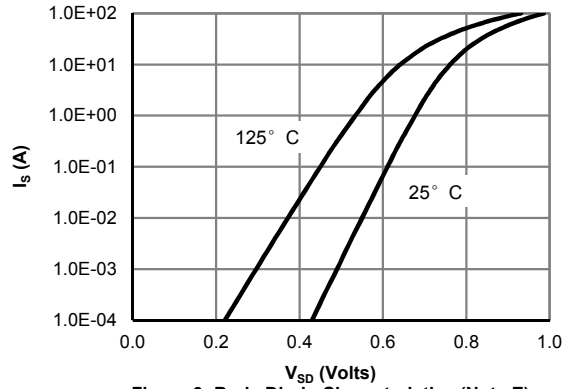

Figure 6: Body-Diode Characteristics (Note E)

TYPICAL ELECTRICAL AND THERMAL CHARACTERISTICS

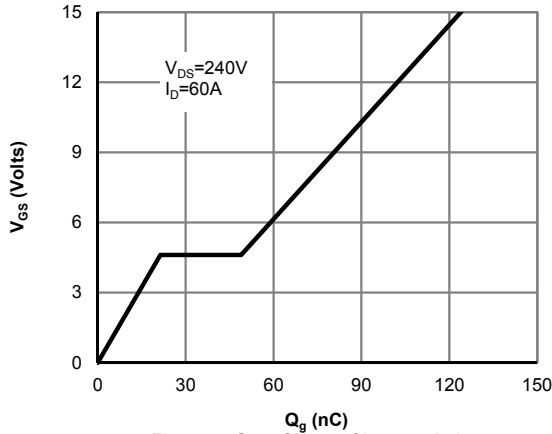

Figure 7: Gate-Charge Characteristics

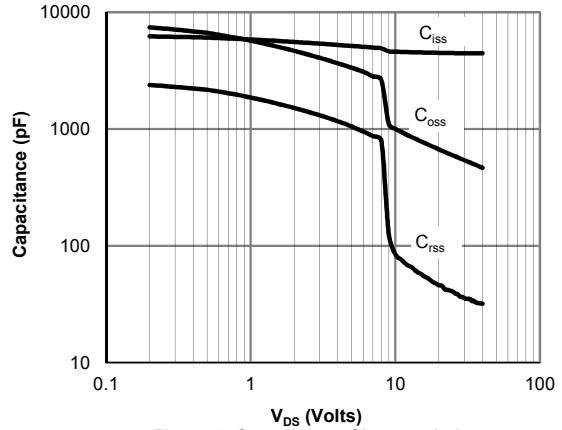

Figure 8: Capacitance Characteristics

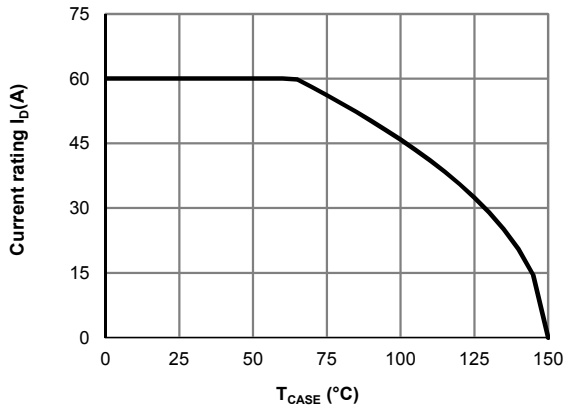

Figure 9: Current De-rating (Note B)

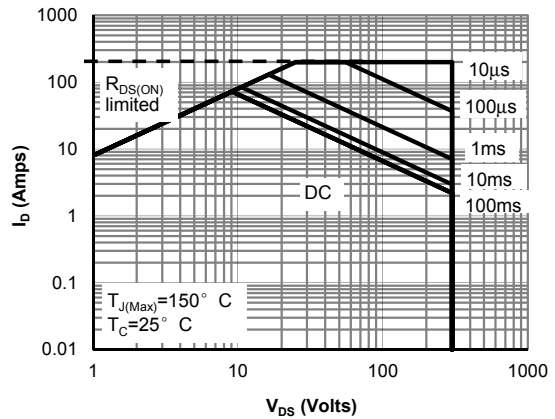

Figure 10: Maximum Forward Biased Safe Operating Area for AOK60N30L (Note F)

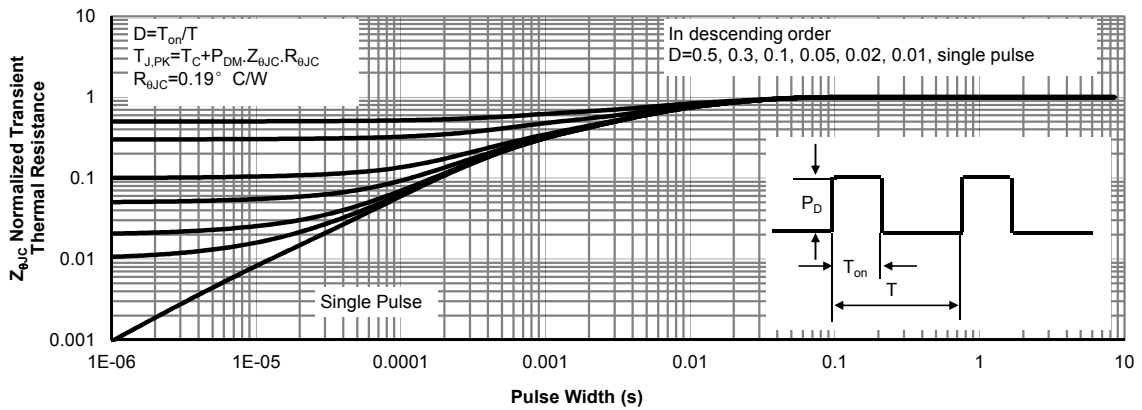
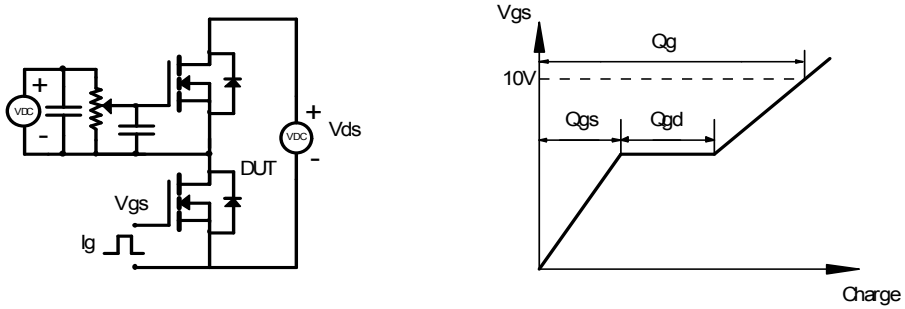
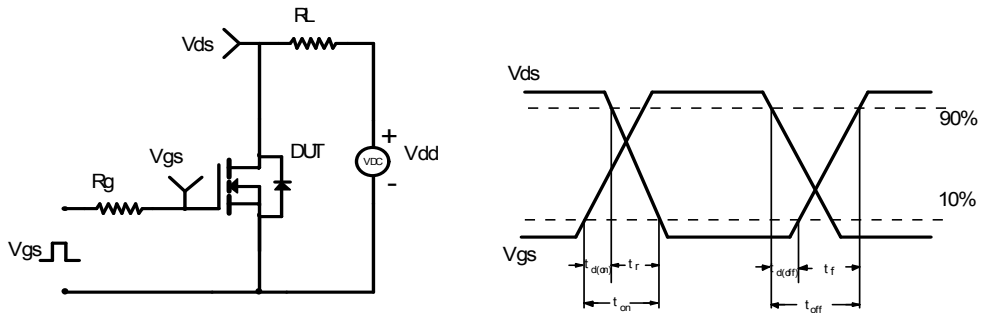

Figure 11: Normalized Maximum Transient Thermal Impedance for AOK60N30L (Note F)

Gate Charge Test Circuit & Waveform



Resistive Switching Test Circuit & Waveforms



Unclamped Inductive Switching (UIS) Test Circuit & Waveforms

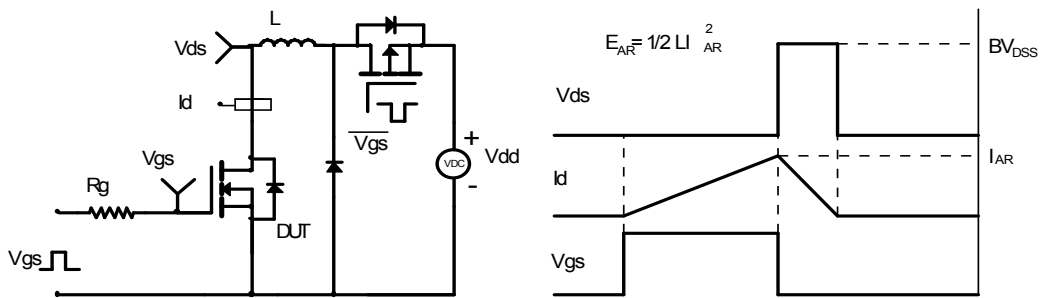

Diode Recovery Test Circuit & Waveforms

