

THIS DRAWING IS UNPUBLISHED.

RELEASED FOR PUBLICATION

REVISIONS

© COPYRIGHT

ALL RIGHTS RESERVED.

P	LTR	DESCRIPTION	DATE	DWN	APVD
	B	REVISED (ECR-06-030161)	28/MAY/07	DH	JK
	B1	REVISED (ECR-18-014392)	11/SEP/18	YH	YJ

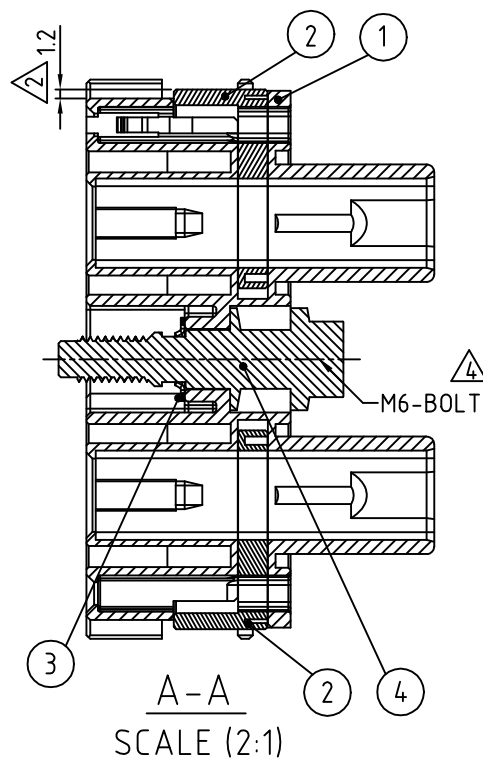
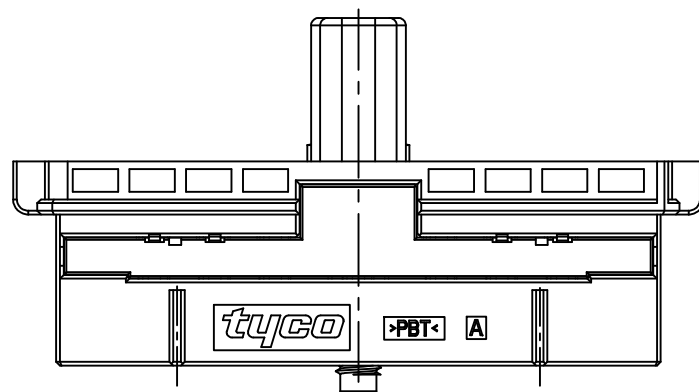

60P HYBRIDE PLUG KEY CODE.

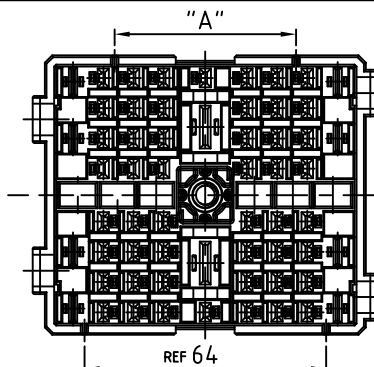

P/N	"A"	COLOR	MATERIAL
0-1743134-2	56	BLACK	PBT
1,2-1743134-3	48	GRAY	PBT

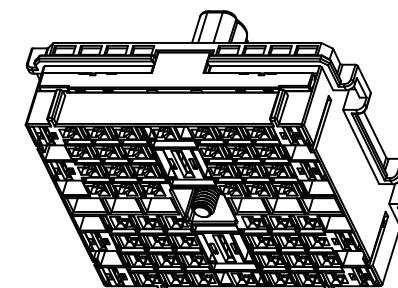

SCALE 1:2

- NOTE.
- GENERAL TOLERANCE IS $\pm 0.3, \pm 3^\circ$
 - CONDITION OF DELIVERY : DBL PLATE PRE-ASSEMBLED POSITION
 - APPLIED RECEPTACLE CONTACT P/N:

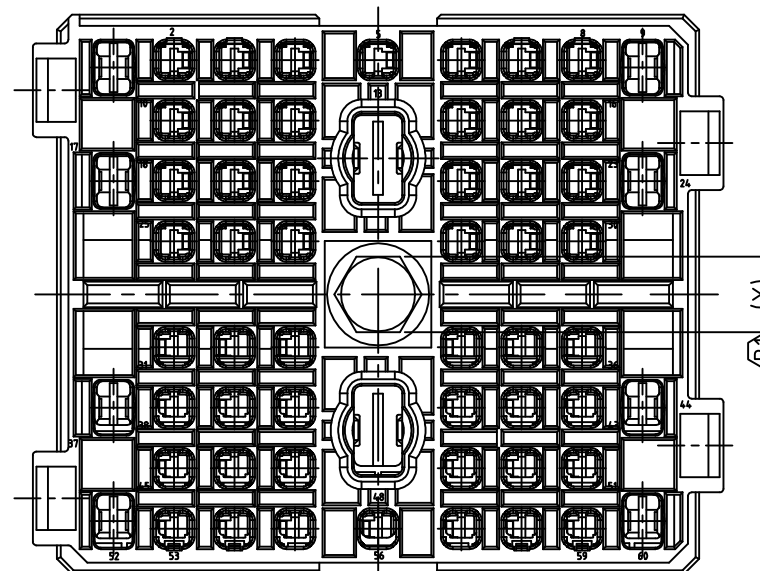
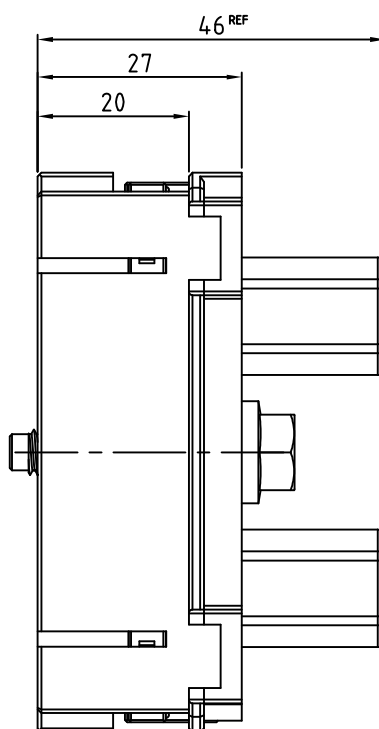
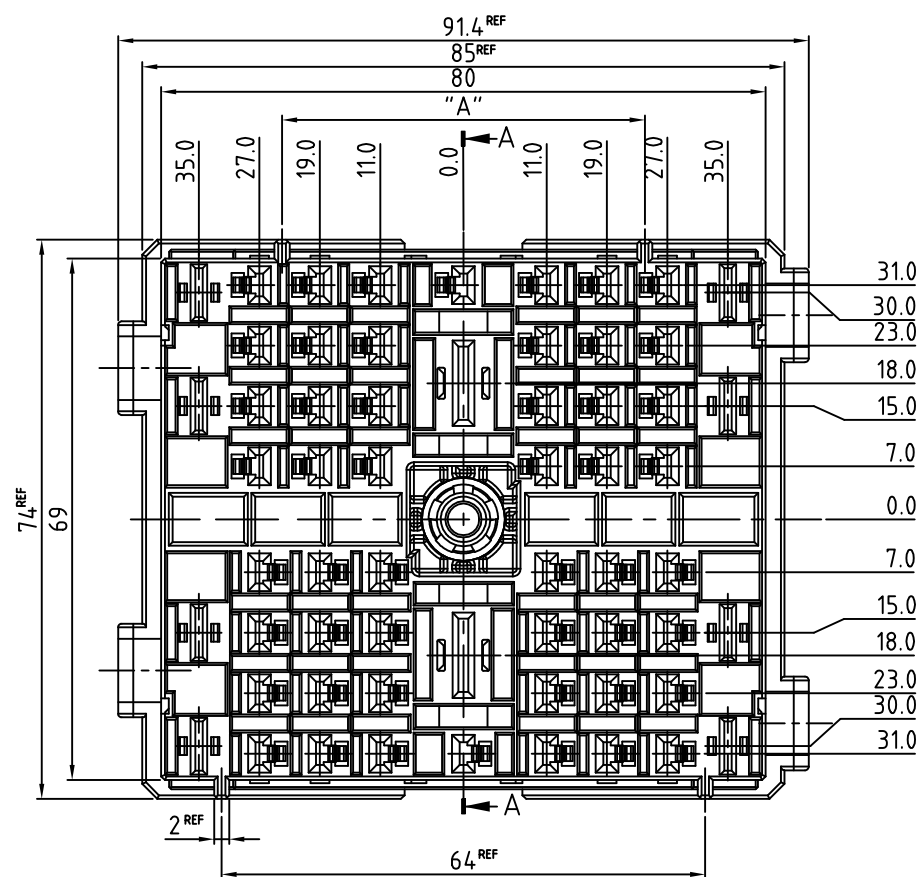

	PART No.	WIRE SIZE(mm)
MCP-E	0-1743162-1	0.3_0.85mm ²
	0-1743163-1	1.25_2.0mm ²
MCP 6.3	0-1241400-1	0.2_0.5mm ²
	0-1241402-1	0.5_1.0mm ²
	0-1241404-1	1.0_2.5mm ²
	0-1241406-1	2.5_4.0mm ²
MCP 9.5	0-1241408-1	4.0_6.0mm ²
	1-967588-1	6.0_10.0mm ²
	1-967589-1	10.0_16.0mm ²

Torque spec 0.8-1.0 Kgf.m

				ASSY P/N	2-1743134-3	1-1743134-3	0-1743134-2
4	M6 BOLT(8mm)	8	-	SWCH10A	1	•	•
	M6 BOLT(10mm)	10	-	SWCH10A	•	1	1
3	PUSH NUT(NEW)	-	-	SUS 304(3/4H)	1	1	1
2	DBL	-	NATURAL	PBT	2	2	2
1	PLUG	-	GRAY	PBT	1	1	•
		-	BLACK	PBT	•	•	1
	NAME	"X"	COLOR	MATERIAL	Q'TY		

THIS DRAWING IS A CONTROLLED DOCUMENT.

DIMENSIONS: mm	TOLERANCES UNLESS OTHERWISE SPECIFIED:
0 PLC ±	1 PLC ±
2 PLC ±	3 PLC ±
3 PLC ±	4 PLC ±
3rd ANGLE PROJECTION	ANGLES ±
MATERIAL	FINISH
SEE TABLE	

DWN YH MA	CHK YH MA	APVD YJ YOUN	PRODUCT SPEC	APPLICATION SPEC	WEIGHT

TE TE Connectivity

NAME

HYBRID 60P PLUG ASS'Y (BOLT TYPE)

SIZE	CAGE CODE	DRAWING NO	RESTRICTED TO
A3	00779	1743134	-
CUSTOMER DRAWING	SCALE 1/1	SHEET 1 OF 1	REV B1