

# CGHV27015S

15 W, DC - 6.0 GHz, 50 V, GaN HEMT

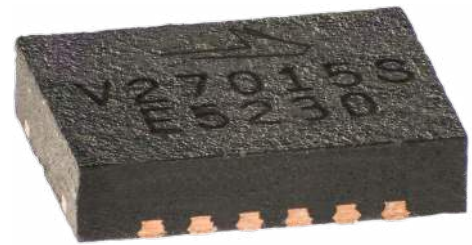

Package Type: 3x4 DFN  
PN: CGHV27015S

## Description

WolfSpeed's CGHV27015S is an unmatched, gallium nitride (GaN) high electron mobility transistor (HEMT) designed specifically for high efficiency, high gain and wide bandwidth capabilities, which makes the CGHV27015S ideal for LTE, 4G Telecom and BWA amplifier applications. The CGHV27015S GaN HEMT device is unmatched so it is suitable for power amplifier applications from 10 MHz through 6000 MHz, such as tactical communications, CATV, UAV data links, as well as a driver stage amplifier for RADAR, EW, and SatCom devices. At a VDD of 50 V, the device provide 2.5 W of average power or 15 W of peak power. At a VDD of 28 V, the device provides 1 W of average power and 7 W of peak power. The transistor is available in a 3 mm x 4 mm, surface mount, dualflat-no-lead (DFN) package.

## Typical Performance Over 2.4-2.7 GHz ( $T_c = 25^\circ\text{C}$ ), 50 V

Parameter	2.4 GHz	2.5 GHz	2.6 GHz	2.7 GHz	Units
Small Signal Gain	23	22	21.7	21.2	dB
Adjacent Channel Power @ $P_{AVE} = 2.5\text{ W}$	-36.7	-40.7	-42.4	-42.5	dBc
Drain Efficiency @ $P_{AVE} = 2.5\text{ W}$	35.9	33.5	30.4	30.2	%
Input Return Loss	-9.3	-9.6	-8.6	-7.8	dB

Note: Measured in the CGHV27015S-AMP1 application circuit. Under 7.5 dB PAR single carrier WCDMA signal test model 1 with 64 DPCH.

### Features for 50 V in CGHV27015S-AMP1

- 2.4 - 2.7 GHz Operation
- 15 W Typical Output Power
- 21 dB Gain at 2.5 W  $P_{AVE}$
- -38 dBc ACLR at 2.5 W  $P_{AVE}$
- 32% efficiency at 2.5 W  $P_{AVE}$
- High degree of APD and DPD correction can be applied



Large Signal Models Available for ADS and MWO



## Absolute Maximum Ratings (not simultaneous) at 25 °C Case Temperature

Parameter	Symbol	Rating	Units	Conditions
Drain-Source Voltage	$V_{DSS}$	150	V	25°C
Gate-to-Source Voltage	$V_{GS}$	-10, +2		
Storage Temperature	$T_{STG}$	-65, +150	°C	
Operating Junction Temperature	$T_J$	225		
Maximum Forward Gate Current	$I_{GMAX}$	2	mA	25°C
Maximum Drain Current <sup>1</sup>	$I_{DMAX}$	0.9	A	
Soldering Temperature <sup>2</sup>	$T_S$	245	°C	
Case Operating Temperature <sup>3</sup>	$T_C$	-40, +150		
Thermal Resistance, Junction to Case <sup>4</sup>	$R_{\theta JC}$	11.1	°C/W	85 °C

### Notes:

<sup>1</sup> Current limit for long term, reliable operation

<sup>2</sup> Refer to the Application Note on soldering at

<https://www.wolfspeed.com/document-library/?productLine=rf>

<sup>3</sup>  $T_C$  = Case temperature for the device. It refers to the temperature at the ground tab underneath the package. The PCB will add additional thermal resistance

<sup>4</sup> Measured for the CGHV27015S at  $P_{DISS} = 5$  W

<sup>5</sup> The  $R_{\theta TH}$  for Wolfspeed's demonstration amplifier, CGH V27015S-AMP1, with 31x0.011 via holes designed on a 20 mil thick Rogers 4350 PCB, is 3.9°C. The total  $R_{\theta TH}$  from the heat sink to the junction is 11.1°C + 3.9°C = 15°C/W

## Electrical Characteristics ( $T_C = 25^\circ\text{C}$ )

Characteristics	Symbol	Min.	Typ.	Max.	Units	Conditions
<b>DC Characteristics<sup>1</sup></b>						
Gate Threshold Voltage	$V_{GS(th)}$	-3.8	-3.0	-2.3	$V_{DC}$	$V_{DS} = 10$ V, $I_D = 2$ mA
Gate Quiescent Voltage	$V_{GS(Q)}$	—	-2.6	—		$V_{DS} = 50$ V, $I_D = 60$ mA
Saturated Drain Current	$I_{DS}$	1.29	1.84	—	A	$V_{DS} = 6.0$ V, $V_{GS} = 2.0$ V
Drain-Source Breakdown Voltage	$V_{(BR)DSS}$	125	—	—	$V_{DC}$	$V_{GS} = -8$ V, $I_D = 2$ mA
<b>RF Characteristics<sup>2</sup> (<math>T_C = 25^\circ\text{C}</math>, <math>F_0 = 2.65</math> GHz unless otherwise noted)</b>						
Gain, Small Signal	G	20.7	22	—	dB	$V_{DD} = 50$ V, $I_{DQ} = 60$ mA, $P_{IN} = 10$ dBm
Output Power <sup>3</sup>	$P_{OUT}$	41.7	42.3	—	dBm	$V_{DD} = 50$ V, $I_{DQ} = 60$ mA, $P_{IN} = 24$ dBm
Drain Efficiency <sup>3</sup>	$\eta$	62	72	—	%	
Output Mismatch Stress <sup>3</sup>	VSWR	—	10:1	—	Y	No damage at all phase angles, $V_{DD} = 50$ V, $I_{DQ} = 60$ mA, $P_{IN} = 24$ dBm
<b>Dynamic Characteristics</b>						
Input Capacitance <sup>4</sup>	$C_{GS}$	—	3.15	—	pF	$V_{DS} = 50$ V, $V_{GS} = -8$ V, $f = 1$ MHz
Output Capacitance <sup>4</sup>	$C_{DS}$	—	1.06	—		
Feedback Capacitance	$C_{GD}$	—	0.058	—		

### Notes:

<sup>1</sup> Measured on wafer prior to packaging

<sup>2</sup> Measured in Wolfspeed's production test fixture. This fixture is designed for high volume test at 2.65 GHz

<sup>3</sup> Un-modulated pulsed signal, 100  $\mu$ s, 10% duty cycle

<sup>4</sup> Includes package and internal matching components



**Typical Performance in Application Circuit CGHV27015S-AMP1**

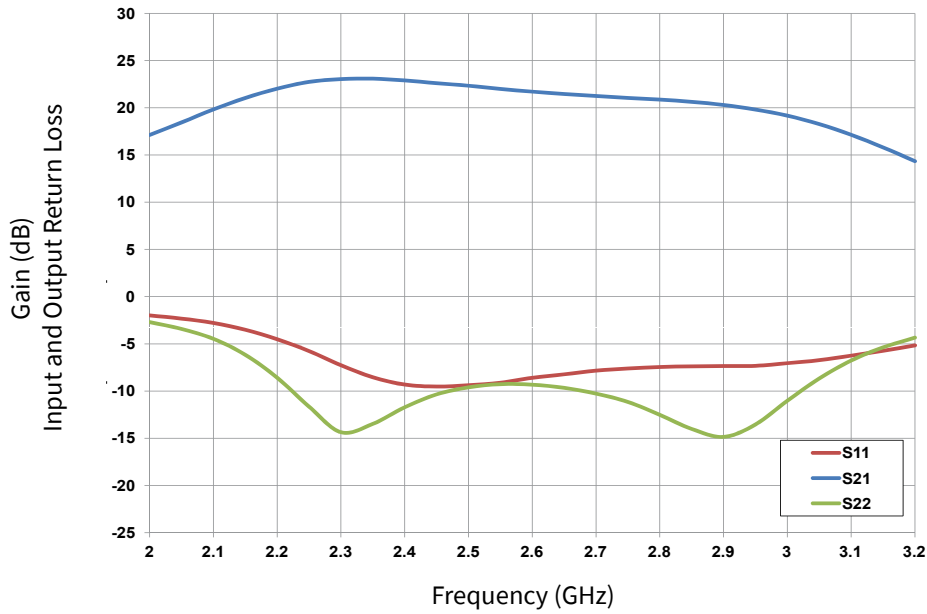

**Figure 1.** Small Signal Gain and Return Losses vs Frequency  
 $V_{DD} = 50\text{ V}, I_{DQ} = 60\text{ mA}$

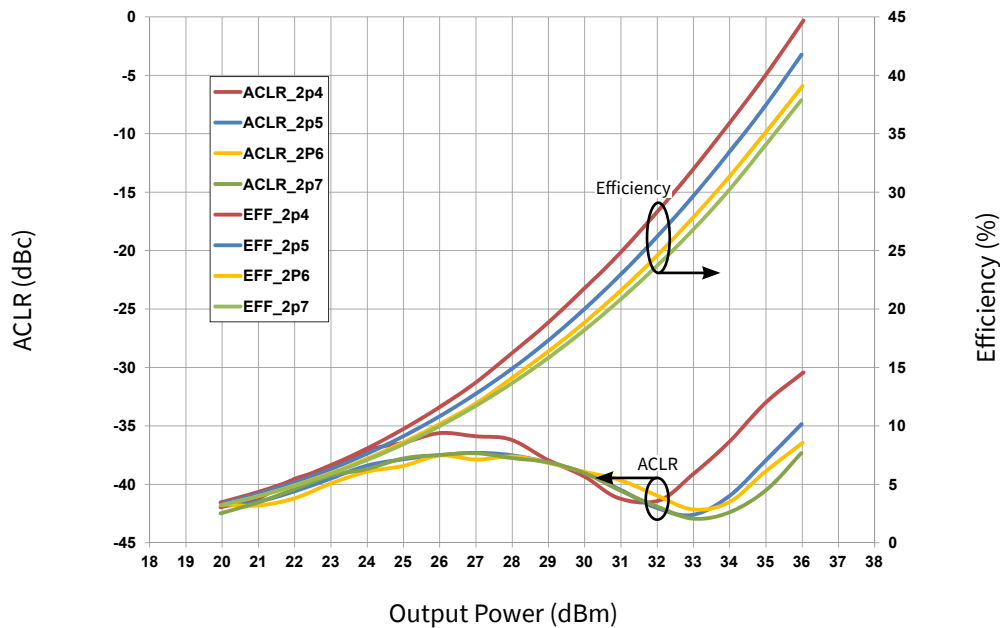

**Figure 2.** Typical Drain Efficiency and ACLR vs. Output Power  
 $V_{DD} = 50\text{ V}, I_{DQ} = 60\text{ mA}, 1\text{ Carrier WCDMA}, \text{PAR} = 7.5\text{ dB}$



### Typical Performance in Application Circuit CGHV27015S-AMP1

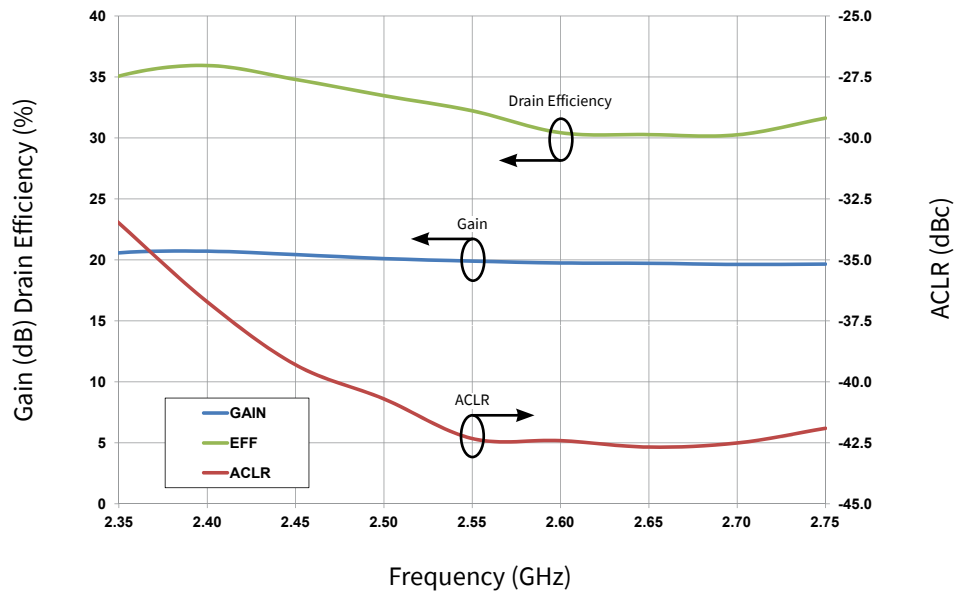

**Figure 3.** Typical Gain, Drain Efficiency and ACLR vs Frequency  
 $V_{DD} = 50\text{ V}$ ,  $I_{DQ} = 60\text{ mA}$ ,  $P_{AVE} = 2.5\text{ W}$ , 1 Carrier WCDMA, PAR = 7.5 dB

### Electrostatic Discharge (ESD) Classifications

Parameter	Symbol	Class	Classification Level	Test Methodology
Human Body Model	HBM	1A	ANSI/ESDA/JEDEC JS-001 Table 3	JEDEC JESD22 A114-D
Charge Device Model	CDM	0CB	ANSI/ESDA/JEDEC JS-002 Table 3	JEDEC JESD22 C101-C

### Moisture Sensitivity Level (MSL) Classification

Parameter	Symbol	Level	Test Methodology
Moisture Sensitivity Level	MSL	3 (168 hours)	IPC/JEDEC J-STD-20



Typical Performance

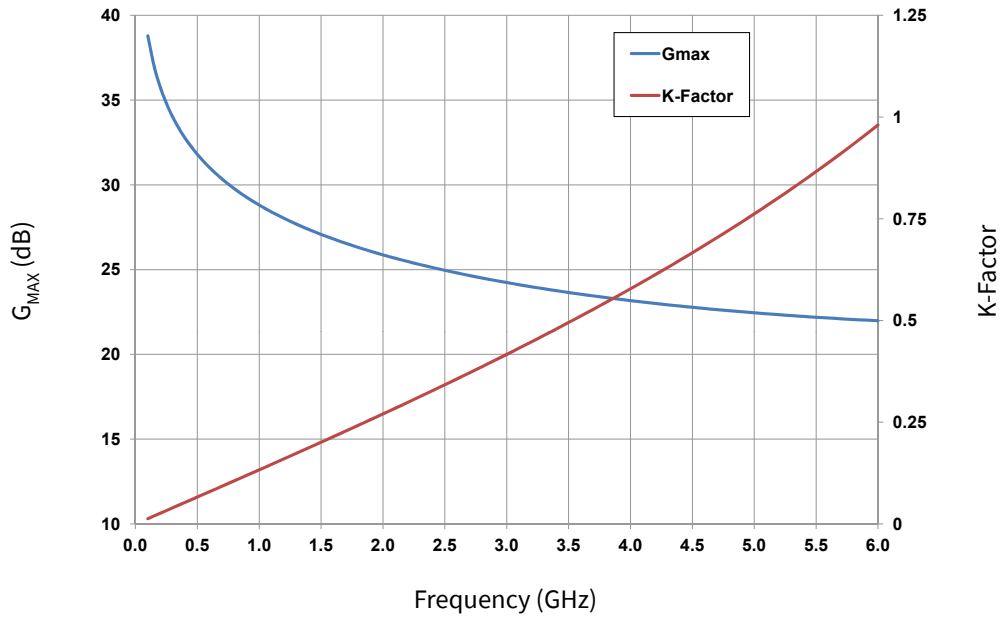

**Figure 4.** G<sub>MAX</sub> and K-Factor vs Frequency  
 $V_{DD} = 50\text{ V}, I_{DQ} = 60\text{ mA}, T_{CASE} = 25^{\circ}\text{C}$



## Source and Load Impedances for Application Circuit CGHV27015S-AMP1

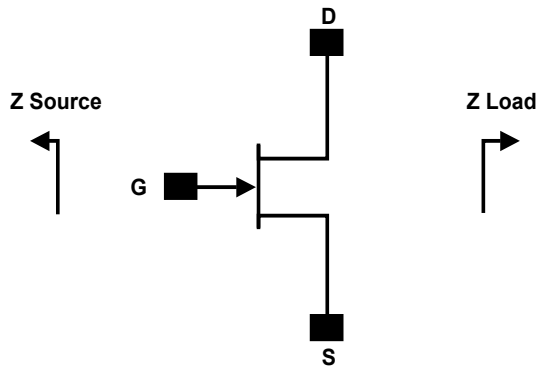

Frequency	Z Source	Z Load
2400	$7.9 + j2.14$	$15.8 + j43.1$
2500	$8 + j2.9$	$18.3 + j43.7$
2600	$7.9 + j3.6$	$19.7 + j43.4$
2700	$7.7 - j4.4$	$19.7 + j43.4$

### Notes:

<sup>1</sup>  $V_{DD} = 50\text{ V}$ ,  $I_{DQ} = 60\text{ mA}$  in the DFN package

<sup>2</sup> Impedances are extracted from the CGHV27015S-AMP1 application circuit and are not source and load pull data derived from the transistor

## CGHV27015S-AMP1 Application Circuit Bill of Materials

Designator	Description	Qty
R1	RES, 332 ohm, +/- 1%, Vishay	1
R2	RES, 22.6 ohm, +/- 1%, 1/16W, 0603	1
R3, R4	RES, 2.2 ohm, +/- 1%, 1/16W, 0603	1
C1, C4	CAP, 27pF, +/- 5%, 0603, ATC	2
C2	CAP, 2.0pF, +/-0.1pF, 0603 ATC	1
C3	CAP, 0.1pF, +/-0.05pF, 0603, ATC	2
C8	CAP, 6.2pF, +/-0.1pF, 0603, ATC	1
C13	CAP, 10pF, +/-5%, 0603, ATC	1
C6, C11	CAP, 33000pF, 0805, ATC	2
C7, C12	CAP, 470pF, 5%, 100V, 0603,	2
C10	CAP, 1.0μF, 100V, 10%, X7R, 1210	1
C5	CAP, 10μF, 16V, TANTALUM	1
C9	CAP, 33μF, 20%, G CASE	1
J1, J2	CONN, SMA, PANEL MOUNT JACK, FLANGE, 4-HOLE, BLUNT POST	2
J3	HEADER RT>PLZ .1CEN LK 5POS	1
Q1	CGHV27015S, DFN	1



**CGHV27015S-AMP1 Application Circuit, 50 V**

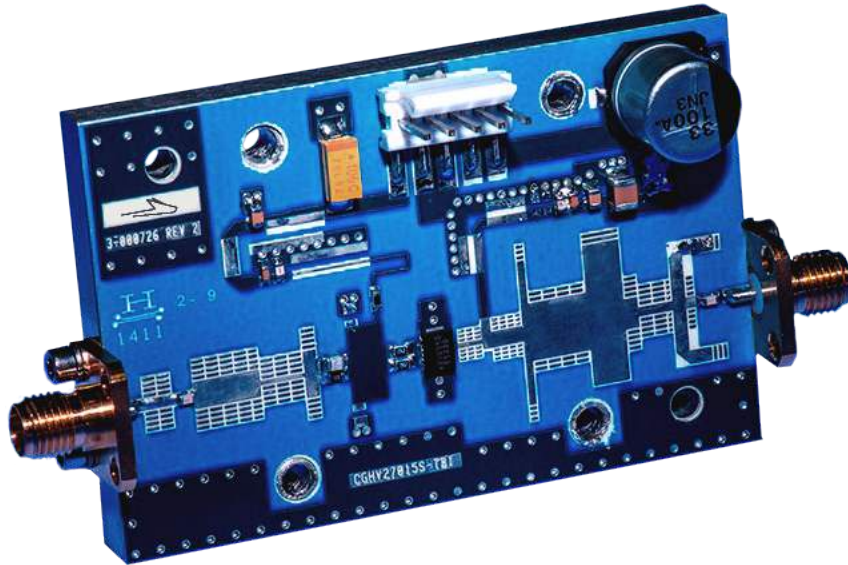

**CGHV27015S-AMP1 Application Circuit Schematic, 50 V**

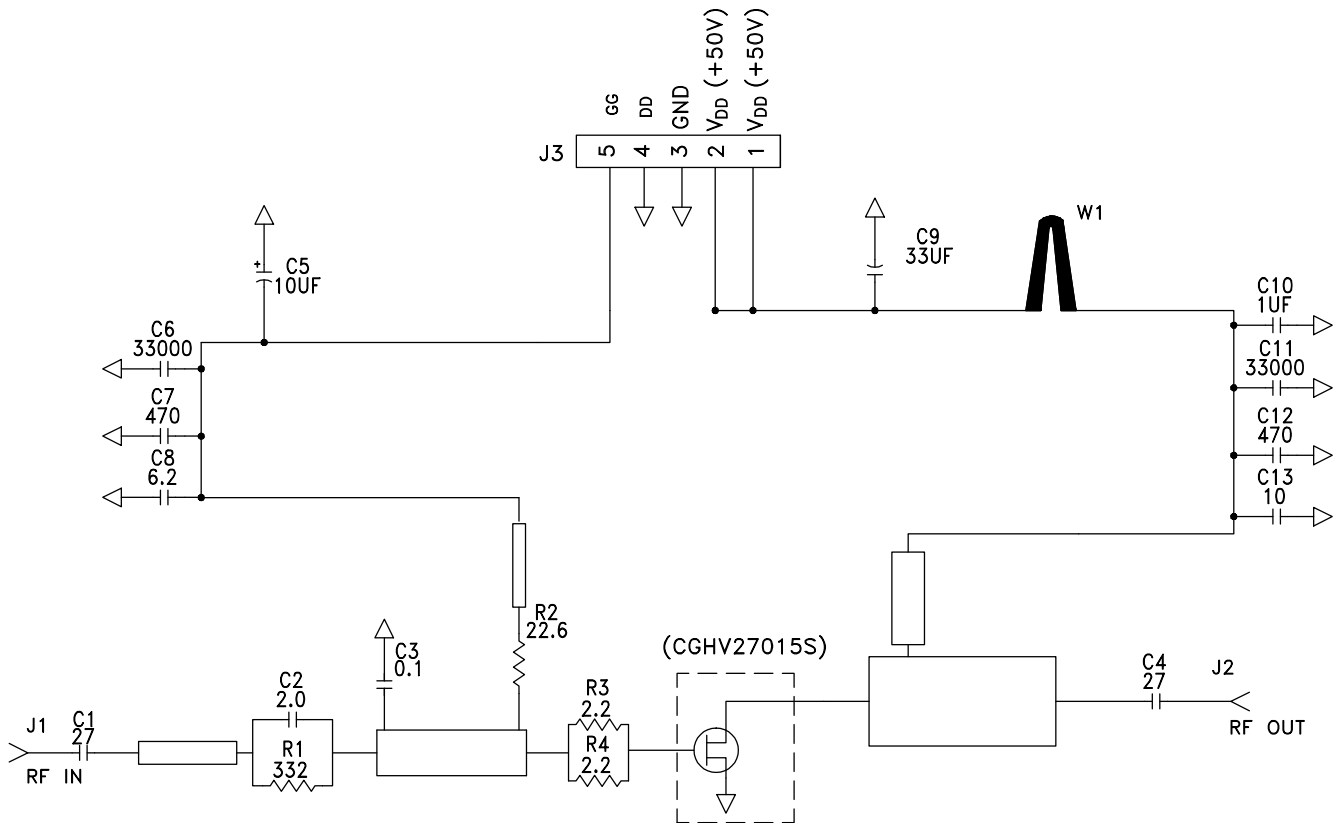



### CGHV27015S-AMP1 Application Circuit, 50 V

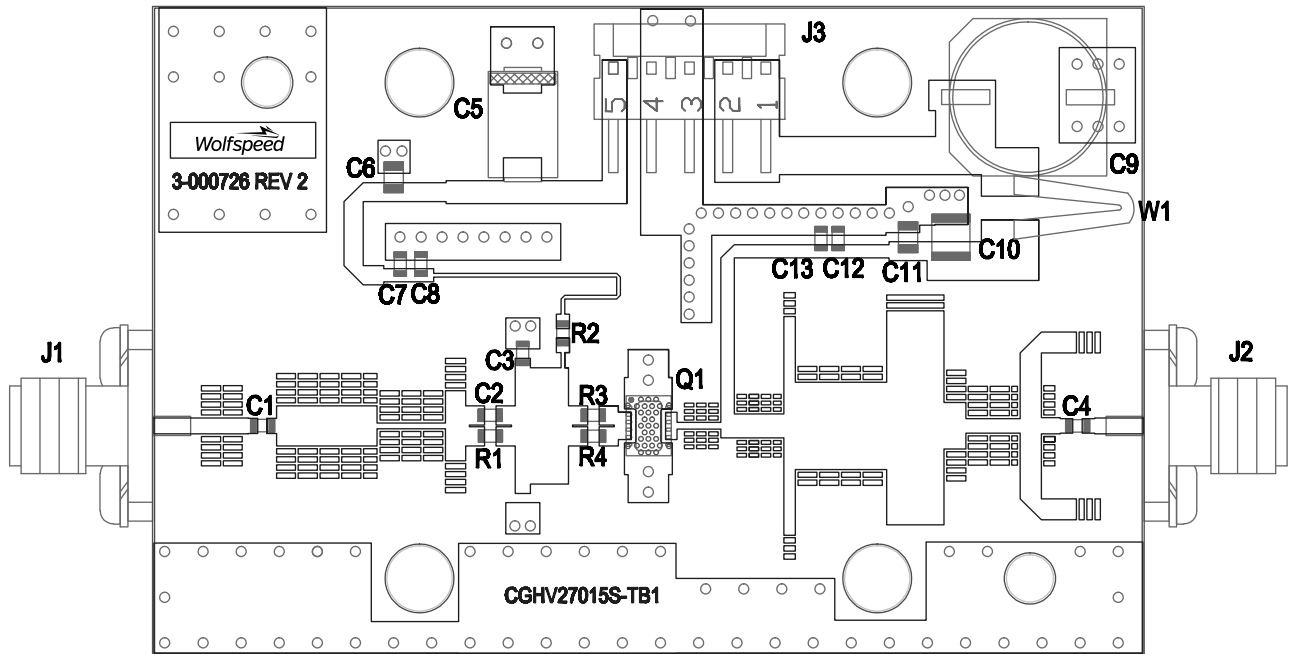





**Product Dimensions CGHV27015S (Package 3 x 4 DFN)**

SYMBOL	COMMON DIMENSIONS			NOTE
	MIN.	NOM.	MAX.	
A	0.80	0.90	1.0	
A1	0.00	0.02	0.05	
A3	0.203 REF.			
Ø	0	—	12	2
D	4.00 BSC			
E	3.00 BSC			
Ⓢ	0.50 BSC			
N	12			3
ND	6			△
L	0.35	0.40	0.45	
b	0.18	0.25	0.30	△
D2	3.20	3.30	3.40	
E2	1.60	1.7	1.80	
K	0.20	—	—	

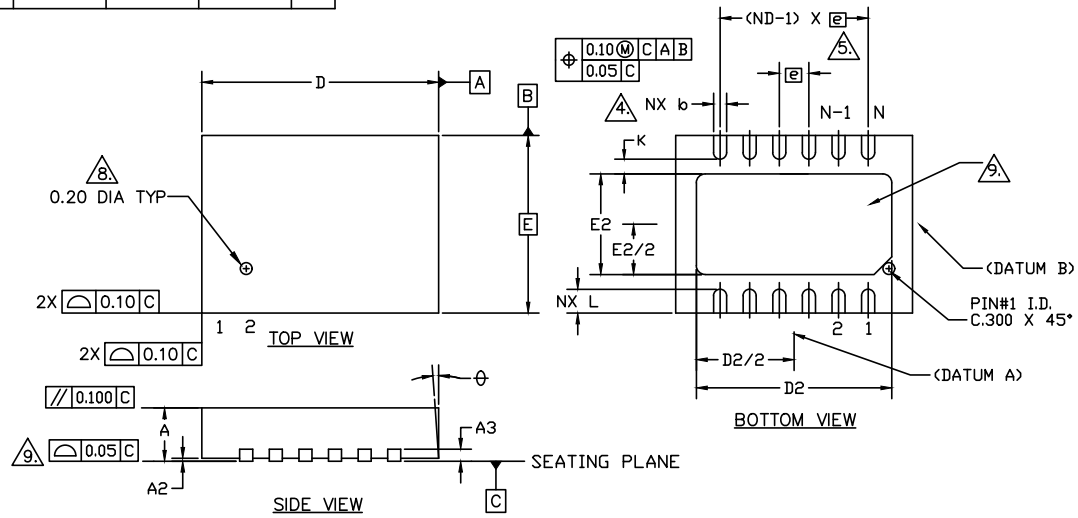

Pin	Input/Output
1	GND
2	NC
3	RF IN
4	RF IN
5	NC
6	GND
7	GND
8	NC
9	RF OUT
10	RF OUT
11	NC
12	GND

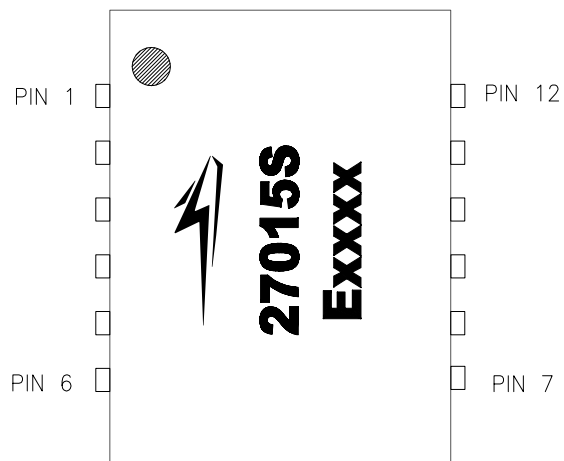

Note: Leadframe finish for 3x4 DFN package is Nickel/Palladium/Gold. Gold is the outer layer.



## Part Number System

### CGHV27015S

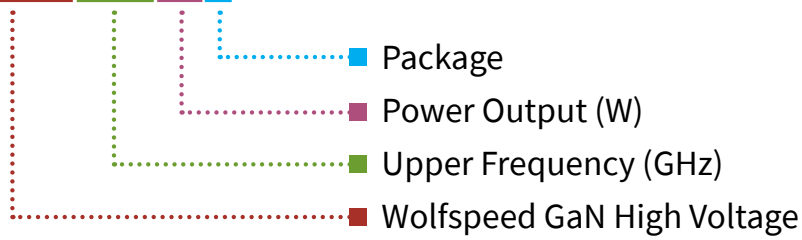

**Table 1.**

Parameter	Value	Units
Upper Frequency <sup>1</sup>	2.7	GHz
Power Output	15	W
Package	Surface Mount	—



Note:

<sup>1</sup> Alpha characters used in frequency code indicate a value greater than 9.9 GHz. See Table 2 for value.

**Table 2.**

Character Code	Code Value
A	0
B	1
C	2
D	3
E	4
F	5
G	6
H	7
J	8
K	9
Examples:	1A = 10.0 GHz 2H = 27.0 GHz

**Product Ordering Information**

Order Number	Description	Unit of Measure	Image
CGHV27015S	GaN HEMT	Each	
CGHV27015S-AMP1	Test board with GaN HEMT installed	Each	

**For more information, please contact:**

4600 Silicon Drive  
Durham, NC 27703 USA  
Tel: +1.919.313.5300  
[www.wolfspeed.com/RF](http://www.wolfspeed.com/RF)

Sales Contact  
[RFSales@wolfspeed.com](mailto:RFSales@wolfspeed.com)

RF Product Marketing Contact  
[RFMarketing@wolfspeed.com](mailto:RFMarketing@wolfspeed.com)

## Notes & Disclaimer

---

Specifications are subject to change without notice. “Typical” parameters are the average values expected by Wolfspeed in large quantities and are provided for information purposes only. Wolfspeed products are not warranted or authorized for use as critical components in medical, life-saving, or life-sustaining applications, or other applications where a failure would reasonably be expected to cause severe personal injury or death. No responsibility is assumed by Wolfspeed for any infringement of patents or other rights of third parties which may result from use of the information contained herein. No license is granted by implication or otherwise under any patent or patent rights of Wolfspeed.

© 2014-2022 Wolfspeed, Inc. All rights reserved. Wolfspeed® and the Wolfstreak logo are registered trademarks and the Wolfspeed logo is a trademark of Wolfspeed, Inc.  
PATENT: <https://www.wolfspeed.com/legal/patents>

*The information in this document is subject to change without notice.*