

| LOC | DIST | REVISIONS | | | | | |
|-----|------|-----------|-----|---------------------|-----------|-----|------|
| | | P | LTN | DESCRIPTION | DATE | DWN | APVD |
| GP | 00 | E3 | | ADD NEW DASH NUMBER | 27DEC2013 | AL | SZ |
| | | | | | | | |
| | | | | | | | |

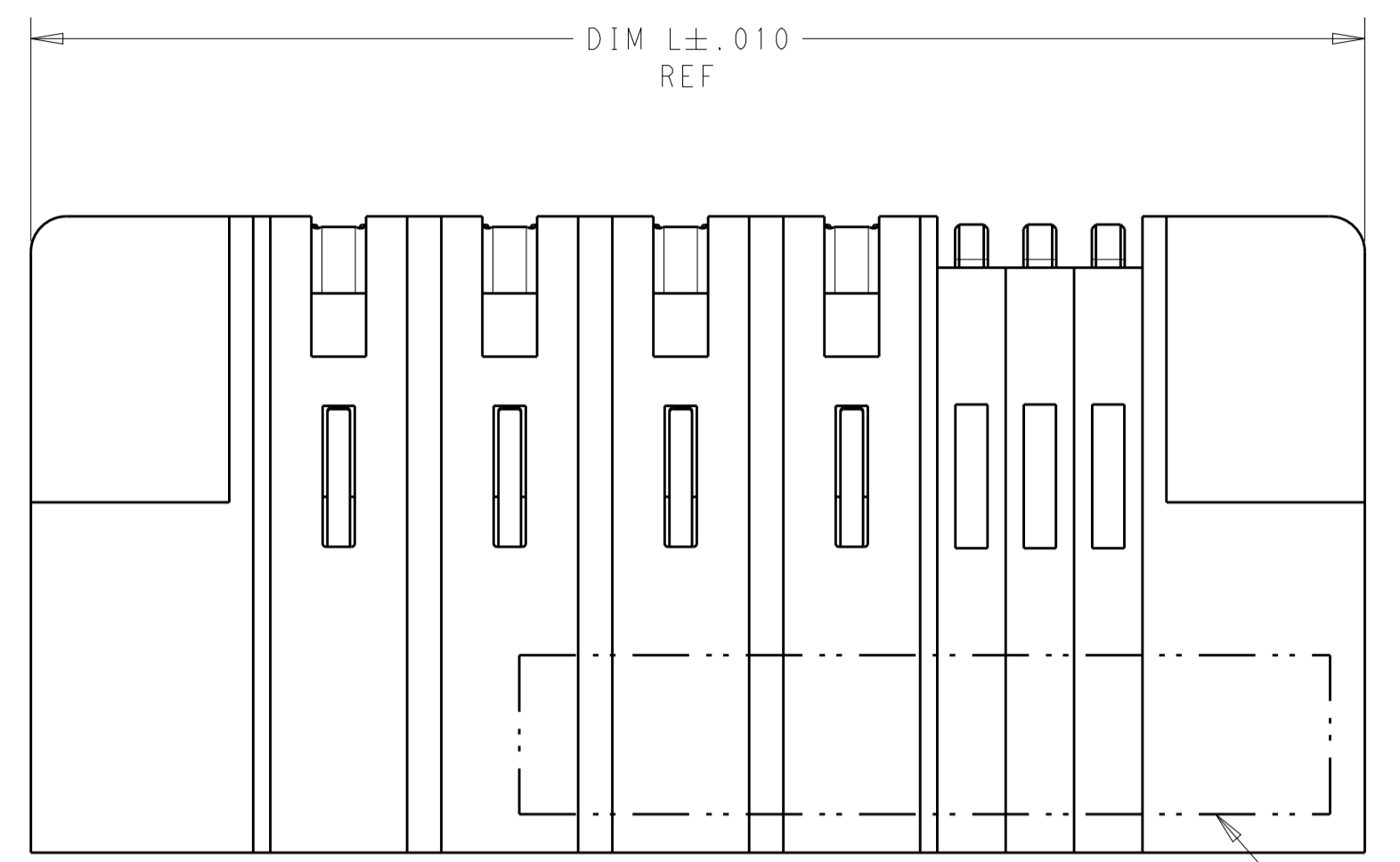

- 1 "AMP" TRADEMARK, PART NUMBER, AND DATE CODE TO BE MARKED IN AREA SHOWN.
- 2 MATERIAL:
HOUSING - GLASS FILLED HIGH TEMP THERMO PLASTIC, BLACK, UL94 V-0
SIGNAL CONTACT - COPPER ALLOY
POWER CONTACT - HIGH CONDUCTIVITY COPPER ALLOY
- 3 CONTACT PLATING: NOBLE METAL PLATING ON CONTACT FUNCTIONAL AREA OF POWER AND SIGNAL CONTACTS
- 4 MECHANICAL CONNECTOR KEEP OUT ZONE
- 5 DATUM AND BASIC DIMENSIONS ESTABLISHED BY CUSTOMER
- 6 PCB - ALL HOLE DIAMETERS ARE FINISHED HOLE SIZES
- 7 PCB - .0453+/- .0010 DRILLED HOLES PLATED WITH .0003 MIN Sn OVER .001 TO .003 PLATING TO ACHIEVE A .040 DIA HOLE
- 8 VARIABLE DIMENSION SHOWN ON TABLE.
- 9 NOT RELEASED FOR PRODUCTION.

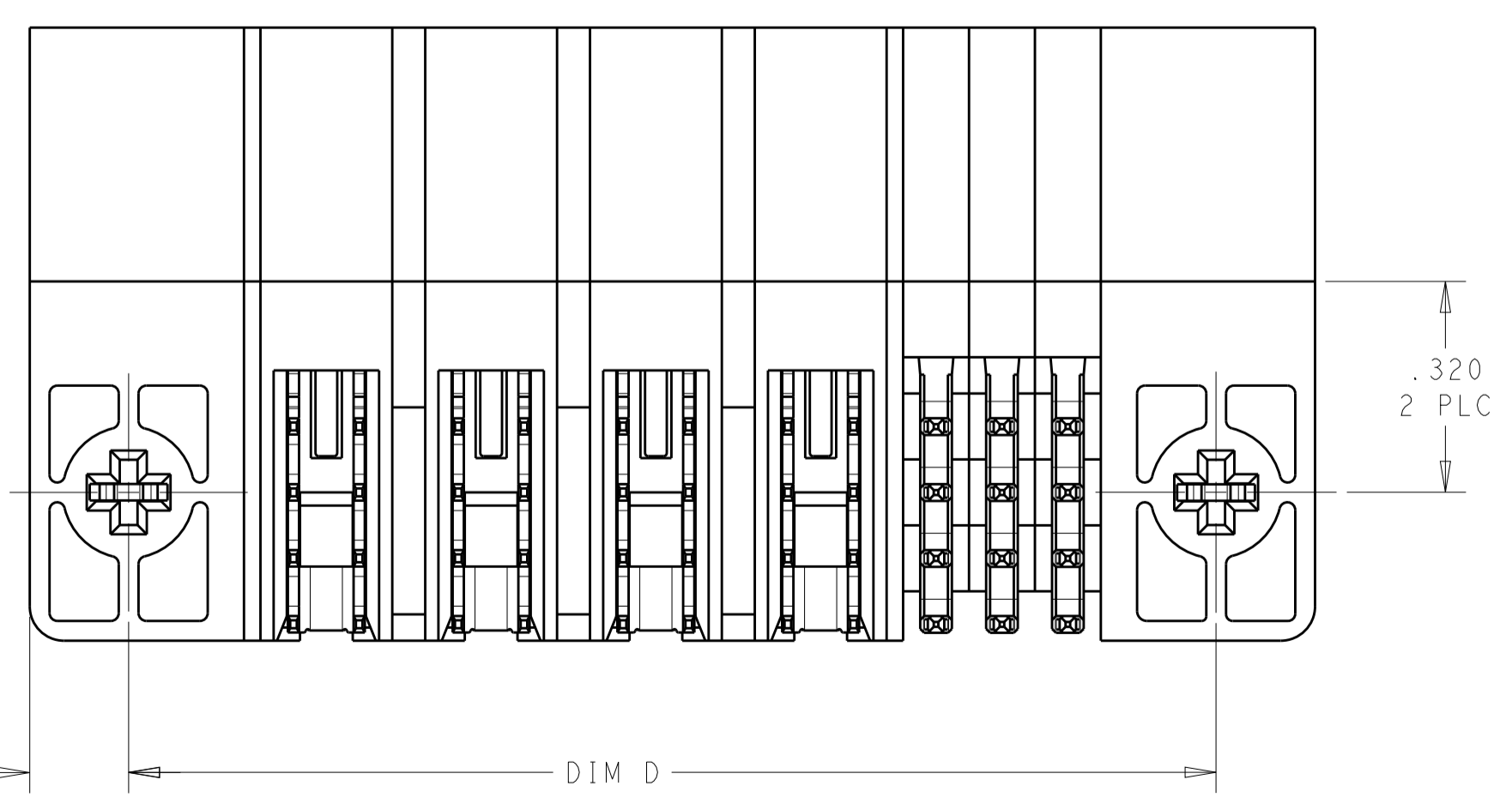
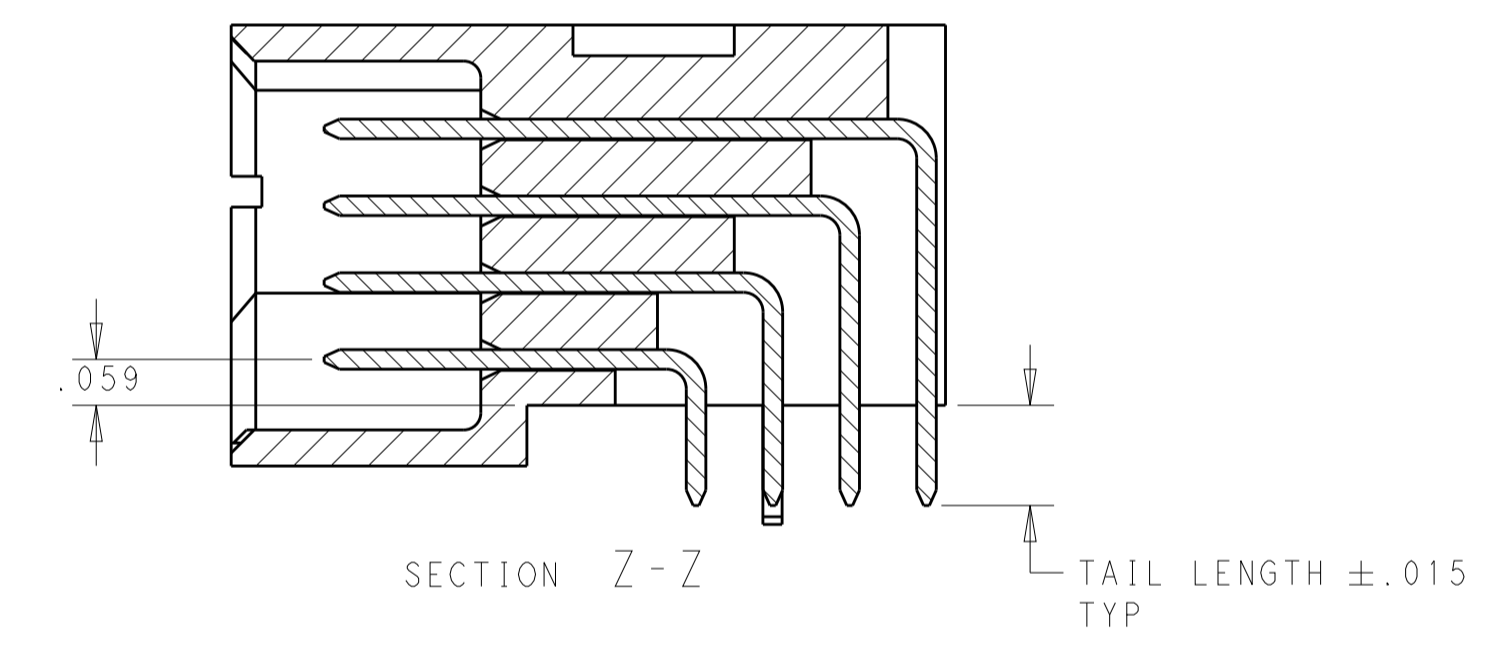
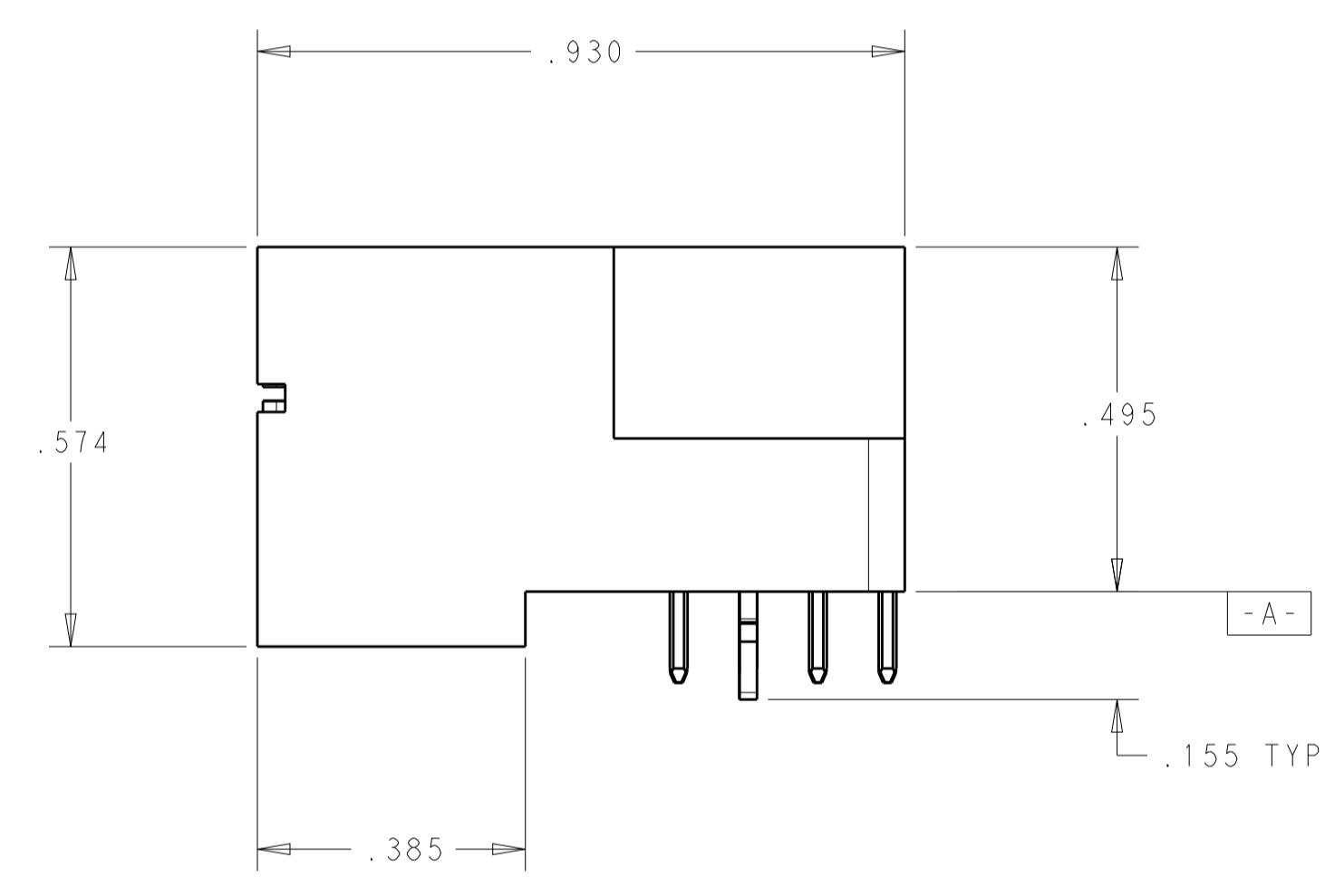
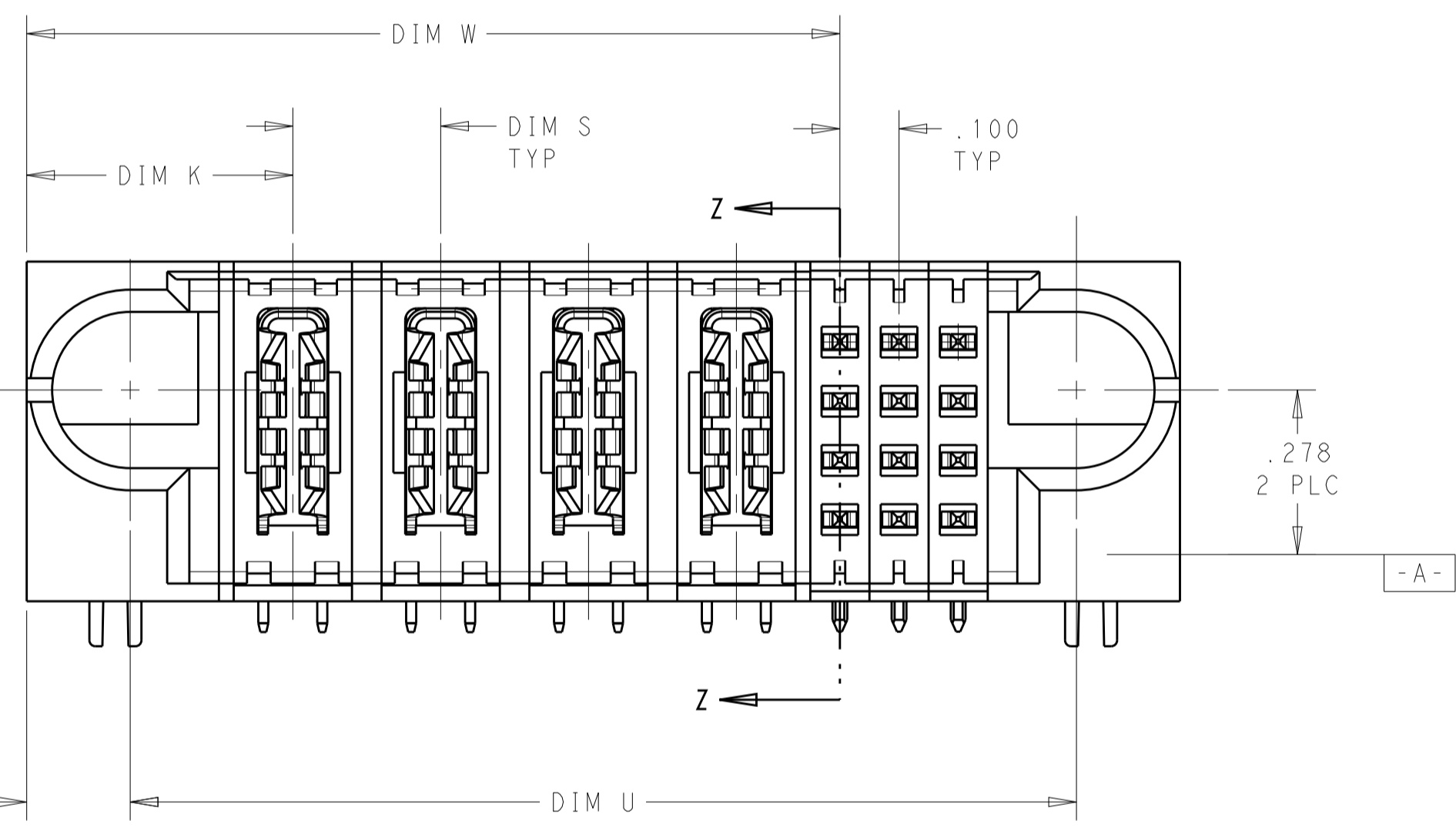

| | | | | |
|--|--|----------------------|----------|---|
| THIS DRAWING IS A CONTROLLED DOCUMENT. | | DWN R. GRZYBOWSKI | 10FEB05 | TE Connectivity |
| DIMENSIONS: INCHES | | CHK M. PERCHERKE | 10FEB05 | |
| TOLERANCES UNLESS OTHERWISE SPECIFIED: | | APVD M. PERCHERKE | | NAME RIGHT ANGLE HEADER ASSEMBLY W/GUIDES MULTI-BEAM XL |
| 0 PLC ± | | PRODUCT SPEC | | |
| 1 PLC ±.01 | | APPLICATION SPEC | 108-1973 | SIZE A100779 |
| 2 PLC ±.005 | | RESTRICTED TO | | |
| 3 PLC ±.0020 | | SCALE | 1:1 | SHEET 1 OF 11 |
| ANGLES ±.2° | | REV | E3 | |
| FINISH | | WEIGHT | | |
| MATERIAL | | CUSTOMER DRAWING | | |

THIS DRAWING IS UNPUBLISHED. RELEASED FOR PUBLICATION 20
 © COPYRIGHT 20 TE CONNECTIVITY ALL RIGHTS RESERVED.

| LOC | DIST | REVISIONS | | | | | |
|-----|------|-----------|-----|-------------|------|-----|------|
| | | P | LTN | DESCRIPTION | DATE | OWN | APVD |
| GP | 00 | - | | SEE SHEET 1 | - | - | - |
| | | | | | | | |
| | | | | | | | |

E3

| | | | | | | | |
|-------|-------|-------|-------|-------|-------|-----------------|-------------|
| 4.050 | △8 | 3.325 | 4.100 | .450 | 4.400 | 4ACP + 9P + 32S | 2-6450132-7 |
| 4.000 | - | .375 | 4.050 | - | 4.350 | 148S | 2-6450132-6 |
| 3.575 | △8 | 3.125 | 3.625 | .450 | 3.925 | 5ACP+6HDP + 20S | 2-6450132-5 |
| 2.950 | .200 | 2.425 | 3.000 | .450 | 3.300 | 10P + 24S | 2-6450132-4 |
| 2.950 | .200 | 2.425 | 3.000 | .450 | 3.300 | 10P + 24S | 2-6450132-3 |
| 3.350 | .200 | 2.825 | 3.400 | .450 | 3.700 | 12HDP + 24S | 2-6450132-2 |
| 2.950 | .200 | 2.425 | 3.000 | .450 | 3.300 | 10P + 24S | 2-6450132-1 |
| 2.150 | .200 | 1.625 | 2.200 | .450 | 2.500 | 6P + 24S | 2-6450132-0 |
| 3.325 | △8 | 2.800 | 3.375 | .425 | 3.675 | 3ACP + 6P + 24S | 1-6450132-9 |
| 2.075 | .300 | 1.550 | 2.125 | .475 | 2.425 | 4ACP + 24S | 1-6450132-8 |
| 4.000 | - | .375 | 4.050 | - | 4.350 | 148S | 1-6450132-7 |
| 2.300 | .250 | 1.875 | 2.350 | .450 | 2.650 | 6P + 20S | 1-6450132-6 |
| 4.700 | .250 | 3.925 | 4.750 | .450 | 5.050 | 14P + 32S | 1-6450132-5 |
| 2.825 | △8 | 2.300 | 2.875 | .475 | 3.175 | 3ACP + 4P + 24S | 1-6450132-3 |
| 2.900 | .250 | 2.375 | 2.950 | .450 | 3.250 | 8P + 24S | 1-6450132-2 |
| 2.250 | .250 | 1.975 | 2.300 | .475 | 2.600 | 6P + 12S | 6450132-8 |
| 2.675 | .250 | 2.125 | 2.725 | .450 | 3.025 | 7P + 24S | 6450132-7 |
| 1.100 | - | .575 | 1.150 | .425 | 1.450 | 1P + 24S | 6450132-6 |
| 2.925 | .250 | 2.375 | 2.975 | .450 | 3.275 | 8P + 24S | 6450132-5 |
| 4.600 | .250 | 3.875 | 4.650 | .450 | 4.950 | 14P + 32S | 6450132-4 |
| 3.000 | .250 | 2.375 | 3.050 | .450 | 3.350 | 8P + 28S | 6450132-3 |
| 1.600 | .250 | 1.375 | 1.650 | .450 | 1.950 | 4P + 12S | 6450132-2 |
| 1.600 | .250 | 1.375 | 1.650 | .450 | 1.950 | 4P + 12S | 6450132-1 |
| DIM U | DIM S | DIM W | DIM D | DIM K | DIM L | DESCRIPTION | PART NUMBER |

△9

△9

△9

THIS DRAWING IS A CONTROLLED DOCUMENT. **OWN** R. GRZYBOWSKI TOFEB05
CHK M. PERCHERKE TOFEB05
APVD M. PERCHERKE

TE TE Connectivity

RIGHT ANGLE HEADER ASSEMBLY W/GUIDES MULTI-BEAM XL

PRODUCT SPEC 108-1973
 APPLICATION SPEC 114-13038

SIZE CAGE CODE DRAWING NO RESTRICTED TO
 A100779C=6450132

CUSTOMER DRAWING SCALE 1:1 SHEET 2 OF 11 REV E3

DIMENSIONS: INCHES
 TOLERANCES UNLESS OTHERWISE SPECIFIED:
 0 PLC ±.01
 1 PLC ±.01
 2 PLC ±.01
 3 PLC ±.005
 4 PLC ±.0020
 ANGLES ±.020
 FINISH

| LOC | DIST | REVISIONS | | | |
|-----|------|-------------|------|----|------|
| GP | 00 | REV | DATE | BY | APPD |
| - | - | SEE SHEET 1 | - | - | - |

| PART NUMBER | ROWS | POWER | | | | SIGNAL | | |
|-------------|------------------|-------|----|----|----|------------------|------------------|------------------|
| | | P1 | P2 | P3 | P4 | 1 | 2 | 3 |
| 6450132-1 | D C B A | PM | PM | | | J K N S | E F N S | J F N S |
| 4P + 12S | | | | | | | | |

| PART NUMBER | ROWS | POWER | | | | SIGNAL | | |
|-------------|------------------|-------|----|----|----|------------------|------------------|------------------|
| | | P1 | P2 | P3 | P4 | 1 | 2 | 3 |
| 6450132-2 | D C B A | PM | PM | PM | PM | J K N S | E F N S | J F N S |
| 4P + 12S | | | | | | | | |

| PART NUMBER | ROWS | POWER | | | | | | | | SIGNAL | | | | | | |
|-------------|------------------|-------|----|----|----|----|----|----|----|------------------|------------------|------------------|------------------|------------------|------------------|------------------|
| | | P1 | P2 | P3 | P4 | P5 | P6 | P7 | P8 | 1 | 2 | 3 | 4 | 5 | 6 | 7 |
| 6450132-3 | D C B A | PM | PM | PM | PM | PM | PM | PM | PM | E F G S | E F G S | E F G S | E F G S | E F G S | E F G S | E F G S |
| 8P + 28S | | | | | | | | | | | | | | | | |

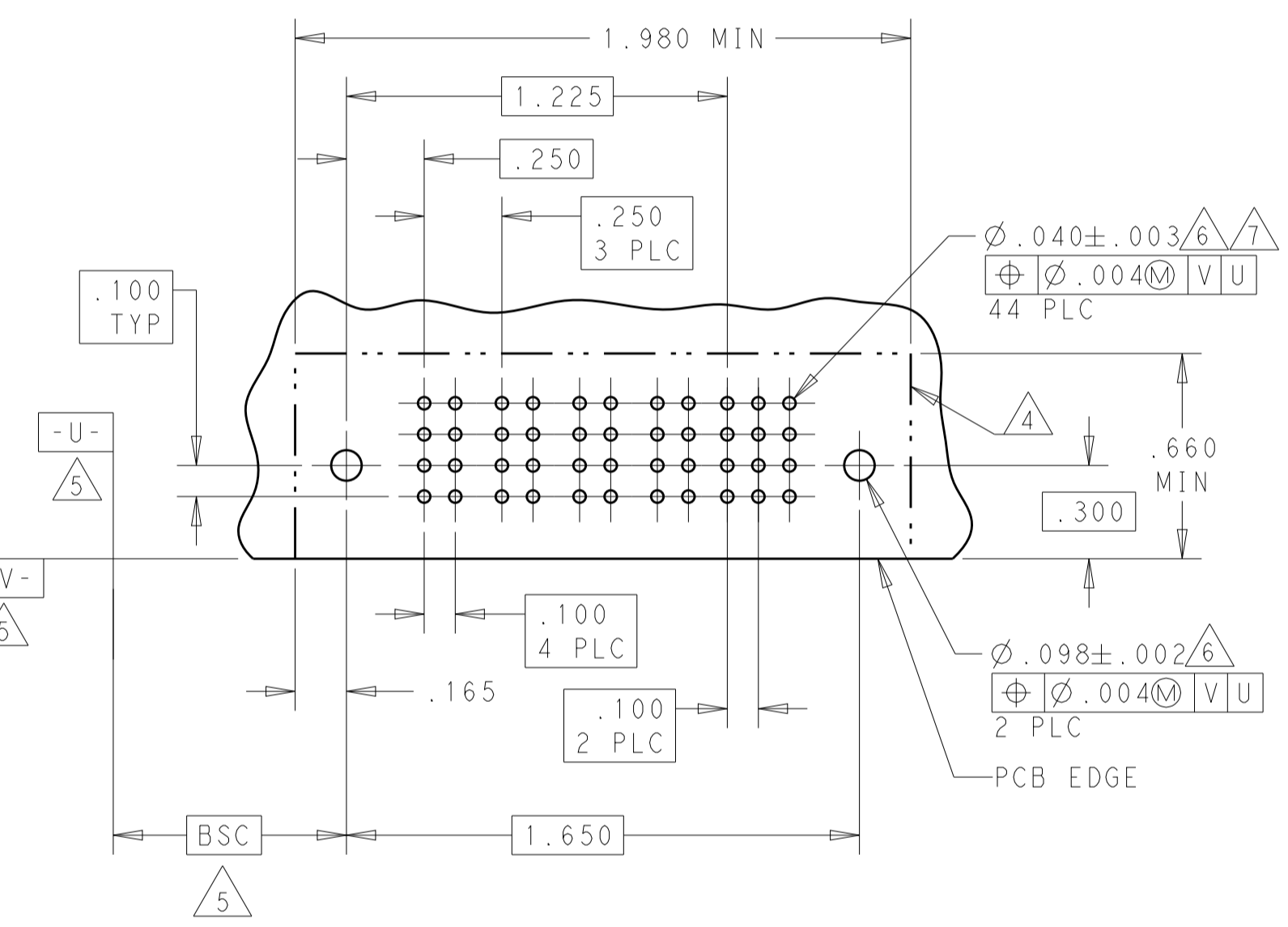
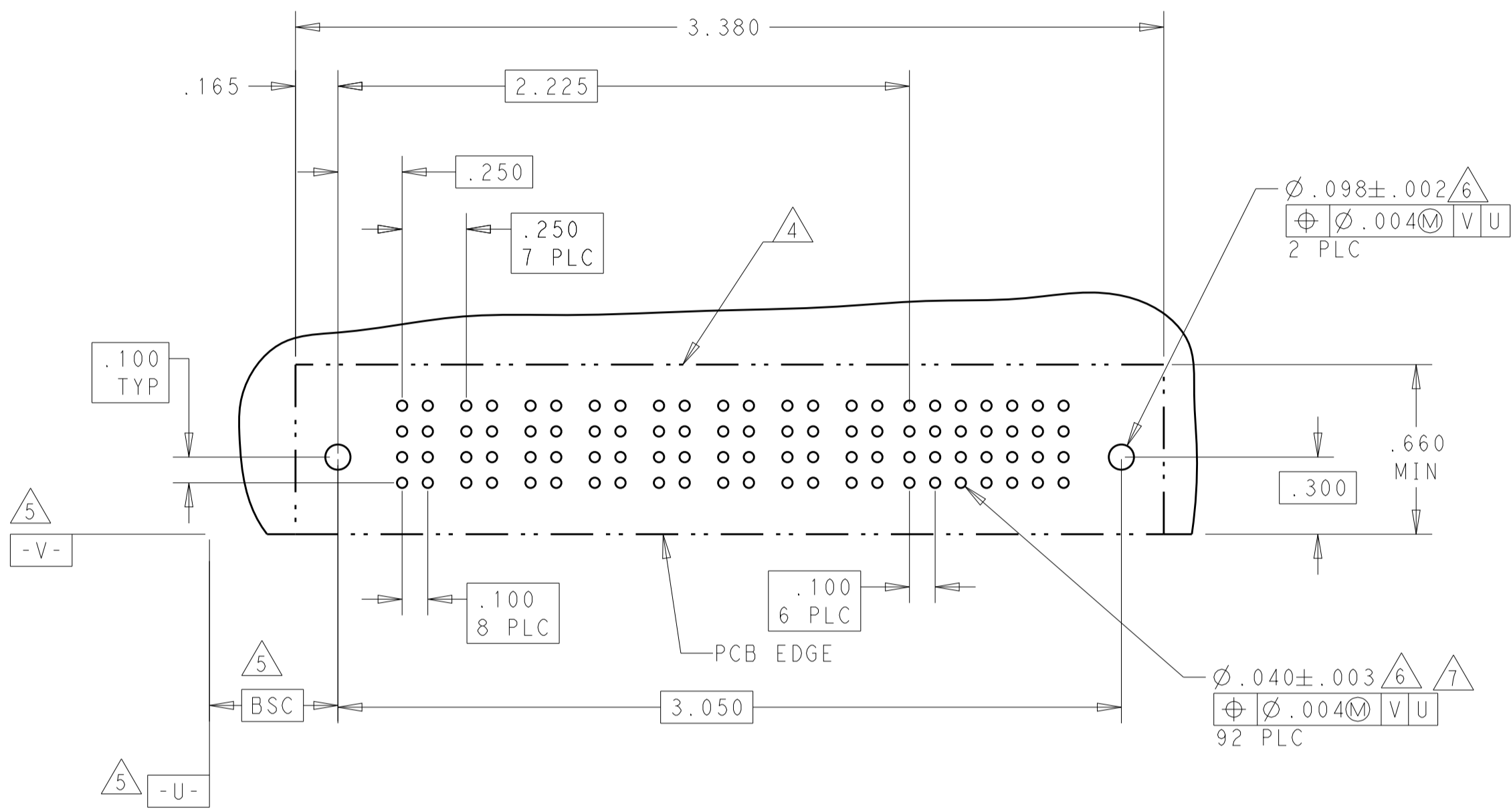

| PART NUMBER | ROWS | POWER | | | | | | | | | | | | | | SIGNAL | | | | | | | | |
|-------------|------------------|-------|----|----|----|----|----|----|----|----|-----|-----|-----|-----|-----|------------------|------------------|------------------|------------------|------------------|------------------|------------------|------------------|--|
| | | P1 | P2 | P3 | P4 | P5 | P6 | P7 | P8 | P9 | P10 | P11 | P12 | P13 | P14 | 1 | 2 | 3 | 4 | 5 | 6 | 7 | 8 | |
| 6450132-4 | D C B A | PM | PM | PM | PM | PM | PM | PM | PM | PM | PM | PM | PM | PM | PM | J K N S | J K N S | J K N S | E F N S | J K N S | J K N S | J K N S | J K N S | |
| 14P + 32S | | | | | | | | | | | | | | | | | | | | | | | | |

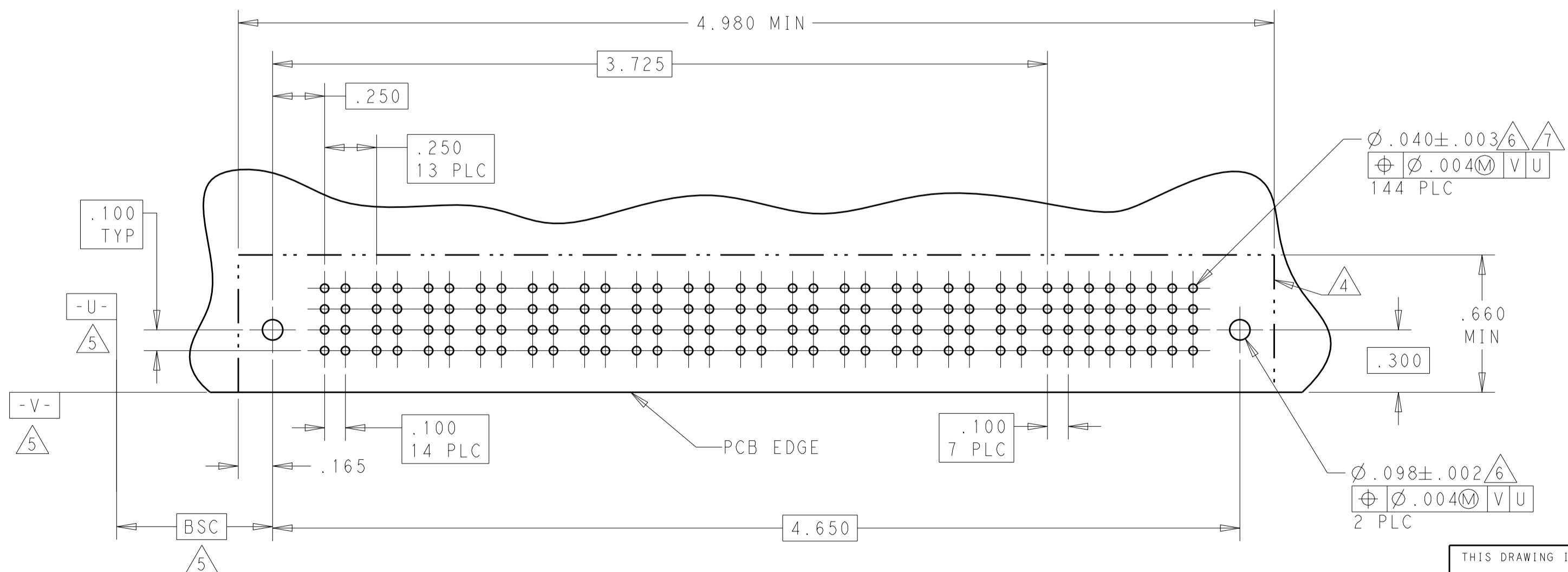

| CODE | MATING SEQUENCE | TAIL LENGTH | ROW |
|------|-----------------|-------------|-----|
| Z | STD | .090 | D |
| Y | STD | .090 | C |
| R | STD | .090 | B |
| O | STD | .090 | A |
| A4 | MLBF | .090 | D |
| A3 | MLBF | .090 | C |
| A2 | MLBF | .090 | B |
| A1 | MLBF | .090 | A |
| E | MLBF | .135 | D |
| F | MLBF | .135 | C |
| G | MLBF | .135 | B |
| H | MLBF | .135 | A |
| J | STD | .135 | D |
| K | STD | .135 | C |
| N | STD | .135 | B |
| S | STD | .135 | A |

| | |
|---------------|-------------|
| PA | .090 |
| PM | .135 |
| CODE | TAIL LENGTH |
| POWER CONTACT | |

THIS DRAWING IS A CONTROLLED DOCUMENT.

OWN: R. GRZYBOWSKI, TOFEBO5
CHK: M. PERCHERKE, TOFEBO5
APVD: M. PERCHERKE

DIMENSIONS: INCHES
TOLERANCES UNLESS OTHERWISE SPECIFIED:
0 PLC ±.01
1 PLC ±.01
2 PLC ±.01
3 PLC ±.01
4 PLC ±.005
ANGLES ±.020

MATERIAL: .
FINISH: .

PRODUCT SPEC: 108-1973
APPLICATION SPEC: 114-13038
WEIGHT: .
CUSTOMER DRAWING

NAME: RIGHT ANGLE HEADER ASSEMBLY W/GUIDES MULTI-BEAM XL
SIZE: A1
CAGE CODE: 6450132
DRAWING NO: 100779
SCALE: 1:1
SHEET 3 OF 11
REV: E3

| LOC | DIST | REV | DATE | BY | APPV |
|-------|------|-------------|------|------|------|
| GP | 00 | | | | |
| P LTH | | DESCRIPTION | | DATE | OWN |
| | | SEE SHEET 1 | | | |

| PART NUMBER | ROWS | POWER | | | | | | | | SIGNAL | | | | | |
|-------------|------------------|-------|----|----|----|----|----|----|----|--------|---|---|---|---|---|
| | | P1 | P2 | P3 | P4 | P5 | P6 | P7 | P8 | 1 | 2 | 3 | 4 | 5 | 6 |
| 6450132-5 | D C B A | PM | PM | PM | PM | PM | PM | PM | PM | J | J | J | J | E | E |
| | | | | | | | | | | K | K | K | K | F | F |
| | | | | | | | | | | N | N | N | N | G | G |
| | | | | | | | | | | S | S | S | S | H | H |
| 8P + 24S | | | | | | | | | | | | | | | |

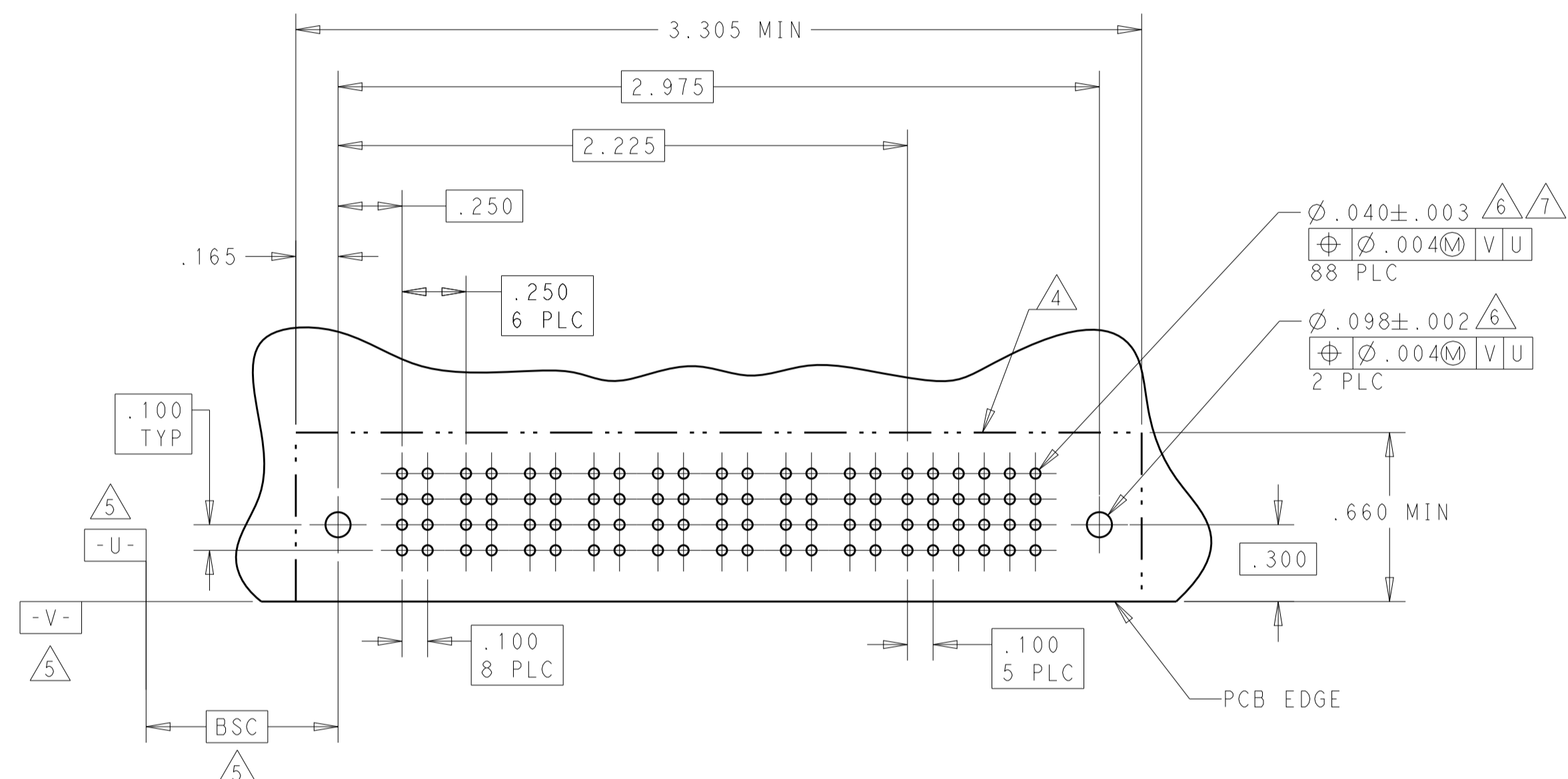

| PART NUMBER | ROWS | POWER | | | | | | SIGNAL | | | | | |
|-------------|------------------|-------|---|---|---|---|---|--------|---|---|---|---|---|
| | | P1 | 1 | 2 | 3 | 4 | 5 | 6 | 1 | 2 | 3 | 4 | 5 |
| 6450132-6 | D C B A | PM | E | E | E | E | J | | | | | | |
| | | | F | F | F | F | F | | | | | | |
| | | | G | G | G | G | G | | | | | | |
| | | | H | H | H | H | H | | | | | | |
| 1P + 24S | | | | | | | | | | | | | |

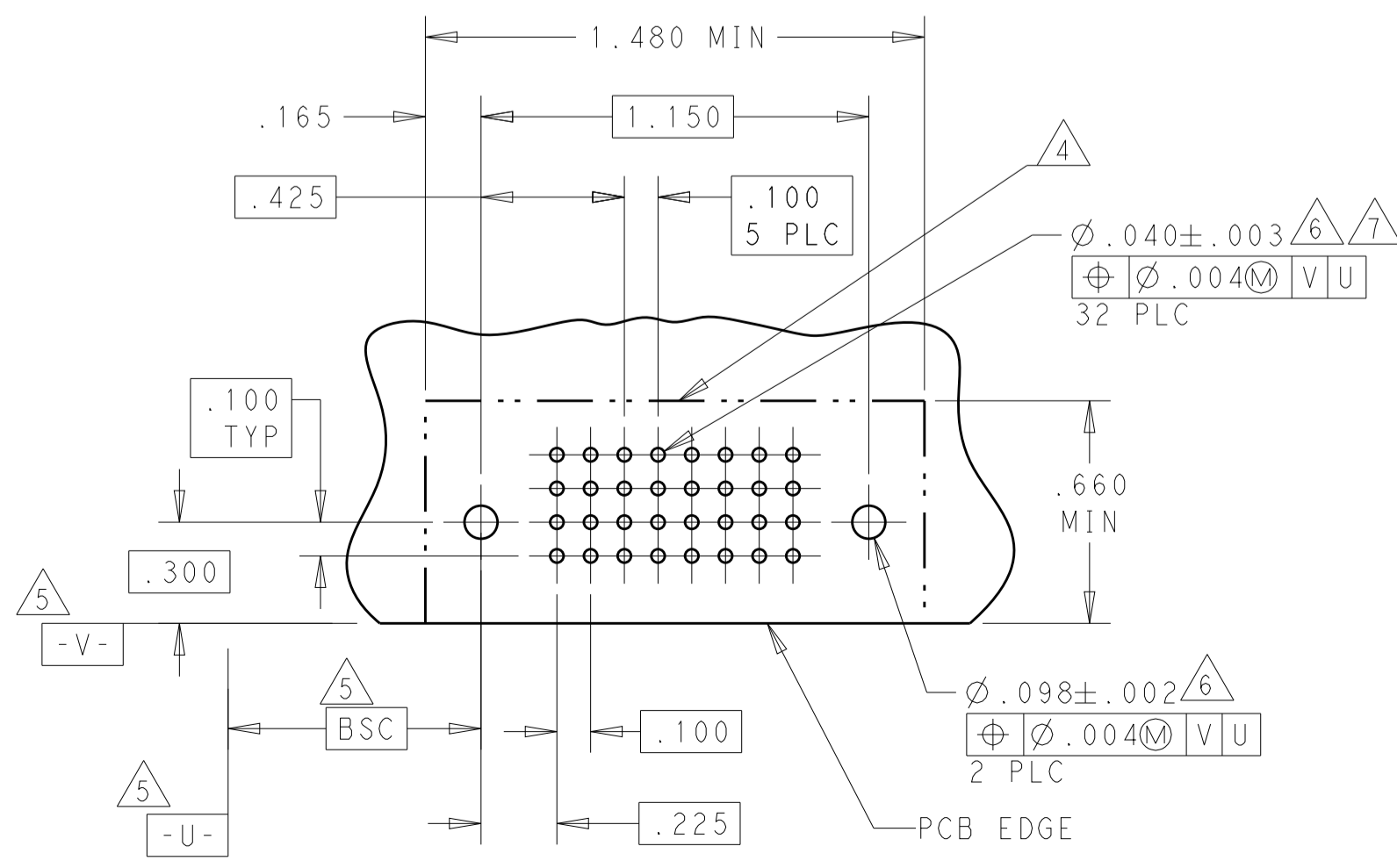

| PART NUMBER | ROWS | POWER | | | | | | | SIGNAL | | | | | |
|-------------|------------------|-------|----|----|----|----|----|----|--------|---|---|---|---|---|
| | | P1 | P2 | P3 | P4 | P5 | P6 | P7 | 1 | 2 | 3 | 4 | 5 | 6 |
| 6450132-7 | D C B A | PM | PM | PM | PM | PM | PM | PM | J | J | E | J | J | J |
| | | | | | | | | | K | K | K | K | K | K |
| | | | | | | | | | N | N | N | N | N | N |
| | | | | | | | | | S | S | S | S | S | S |
| 7P + 24S | | | | | | | | | | | | | | |

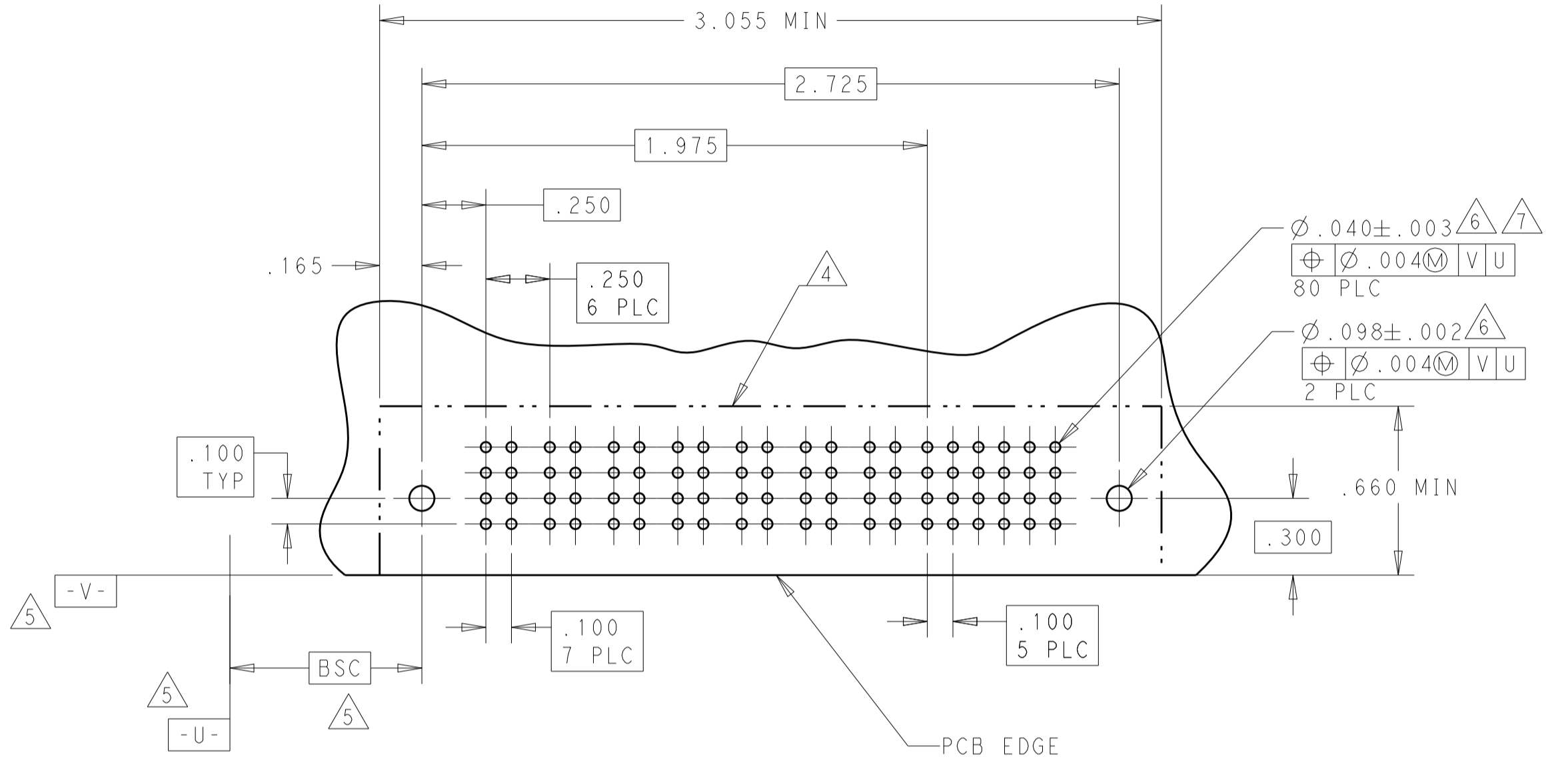

| PART NUMBER | ROWS | POWER | | | | | | SIGNAL | | |
|-------------|------------------|-------|----|----|----|----|----|--------|---|---|
| | | P1 | P2 | P3 | P4 | P5 | P6 | 1 | 2 | 3 |
| 6450132-8 | D C B A | PM | PM | PM | PM | PM | PM | E | E | |
| | | | | | | | | F | F | |
| | | | | | | | | G | G | |
| | | | | | | | | H | H | |
| 6P + 12S | | | | | | | | | | |

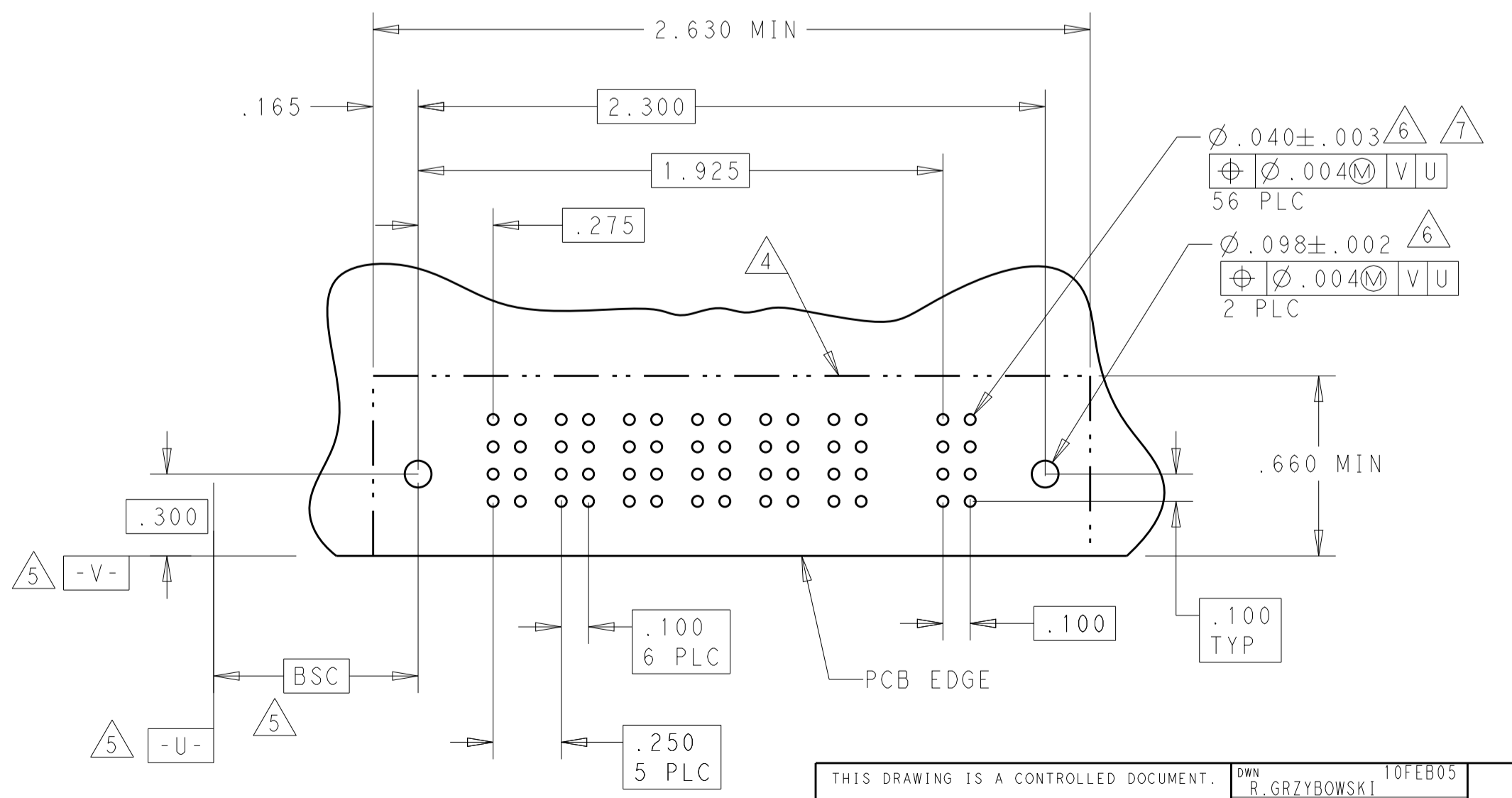

THIS DRAWING IS A CONTROLLED DOCUMENT. OWN: R. GRZYBOWSKI, TOFEB05, CHK: M. PERCHERKE, APVD: M. PERCHERKE, NAME: RIGHT ANGLE HEADER ASSEMBLY W/GUIDES MULTI-BEAM XL, PRODUCT SPEC: 108-1973, APPLICATION SPEC: 114-13038, SIZE: A1, CAGE CODE: 114-13038, DRAWING NO: 100779, SHEET 4 OF 11, REV: E3, SCALE: 1:1.

| LOC | DIST | REVISIONS | | | |
|-----|------|-------------|------|-----|------|
| P | LTN | DESCRIPTION | DATE | DMN | APVD |
| GP | 00 | SEE SHEET 1 | | | |

| PART NUMBER | ROWS | POWER | | | | | | | | SIGNAL | | | | | |
|-------------|------------------|-------|----|----|----|----|----|----|----|--------|---|---|---|---|---|
| | | P1 | P2 | P3 | P4 | P5 | P6 | P7 | P8 | 1 | 2 | 3 | 4 | 5 | 6 |
| 1-6450132-2 | D C B A | PM | PM | PM | PM | PM | PM | PM | PM | J | J | J | J | E | E |
| | | PM | PM | PM | PM | PM | PM | PM | PM | K | K | K | K | F | F |
| | | PM | PM | PM | PM | PM | PM | PM | PM | N | N | N | N | G | G |
| | | PM | PM | PM | PM | PM | PM | PM | PM | S | S | S | S | H | H |
| 8P + 24S | | | | | | | | | | | | | | | |

| PART NUMBER | ROWS | POWER | | | | | | | | | | | | | | SIGNAL | | | | | | | |
|-------------|------------------|-------|----|----|----|----|----|----|----|----|-----|-----|-----|-----|-----|--------|---|---|---|---|---|---|---|
| | | P1 | P2 | P3 | P4 | P5 | P6 | P7 | P8 | P9 | P10 | P11 | P12 | P13 | P14 | 1 | 2 | 3 | 4 | 5 | 6 | 7 | 8 |
| 1-6450132-5 | D C B A | PM | PM | PM | PM | PM | PM | PM | PM | PM | PM | PM | PM | PM | PM | E | J | J | J | E | J | J | J |
| | | PM | PM | PM | PM | PM | PM | PM | PM | PM | PM | PM | PM | PM | PM | F | K | K | K | F | K | K | K |
| | | PM | PM | PM | PM | PM | PM | PM | PM | PM | PM | PM | PM | PM | PM | N | N | N | N | N | N | N | N |
| | | PM | PM | PM | PM | PM | PM | PM | PM | PM | PM | PM | PM | PM | PM | S | S | S | S | S | S | S | S |
| 14P + 32S | | | | | | | | | | | | | | | | | | | | | | | |

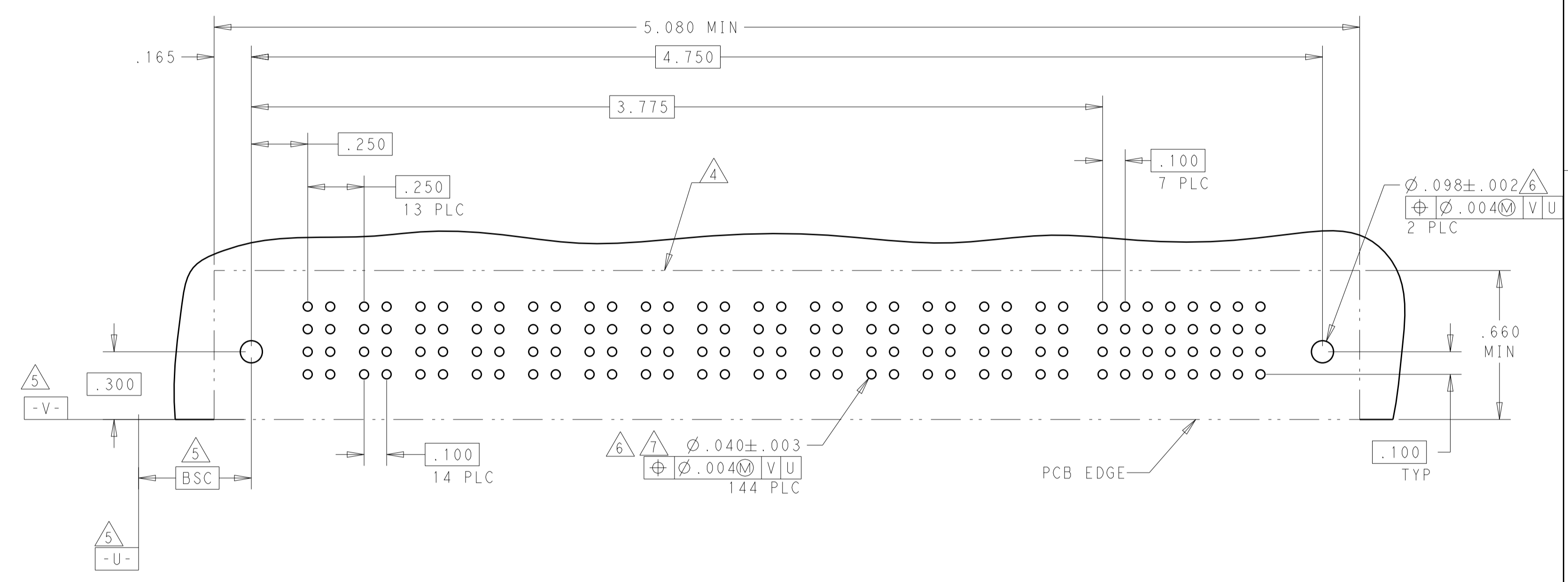
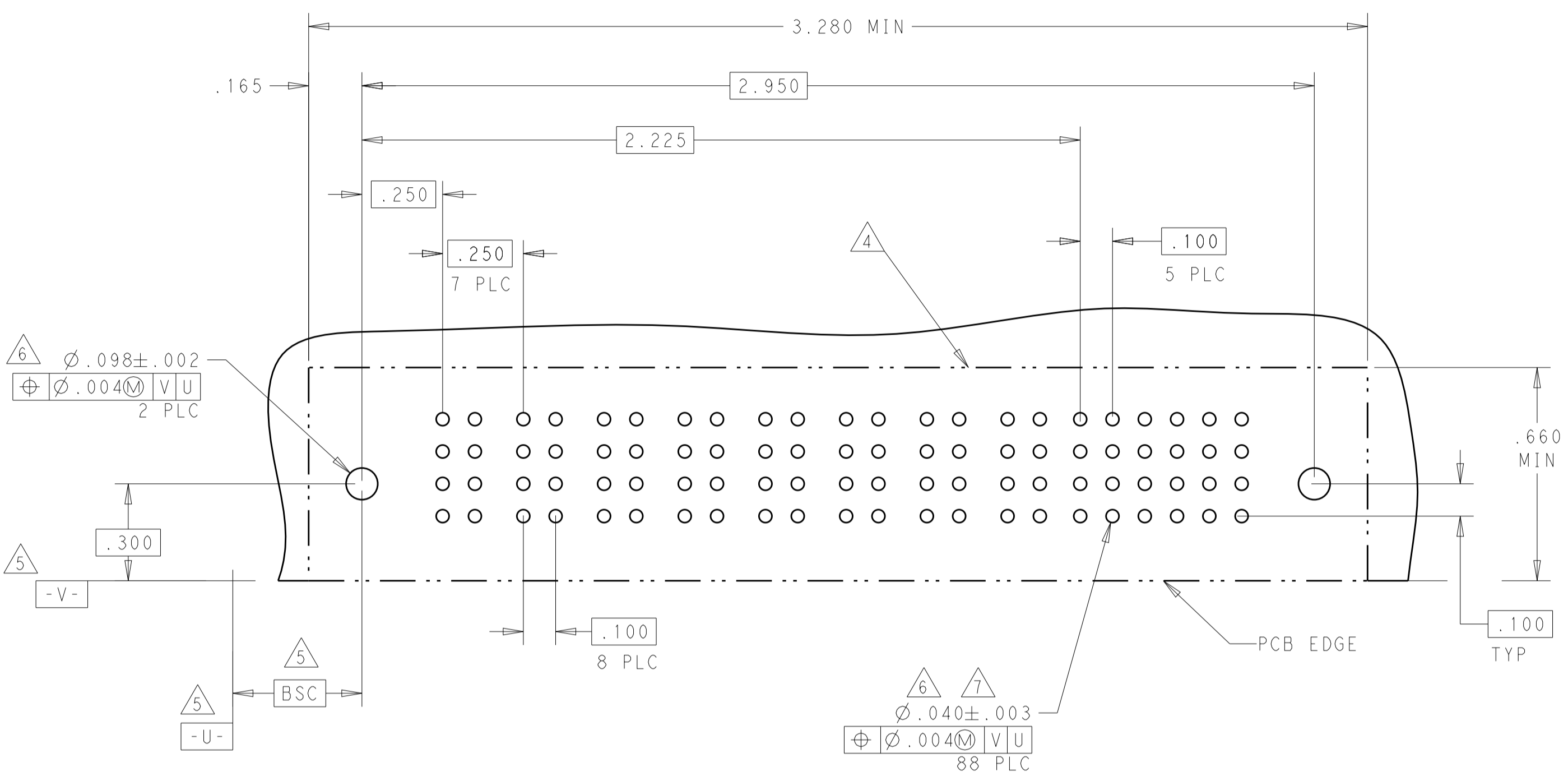

| PART NUMBER | ROWS | POWER | | | | | | | SIGNAL | | | | | | |
|-----------------|------------------|-------|----|----|----|----|----|----|--------|---|---|---|---|---|--|
| | | P1 | P2 | P3 | P4 | P5 | P6 | P7 | 1 | 2 | 3 | 4 | 5 | 6 | |
| 1-6450132-3 | D C B A | PM | PM | PM | PM | PM | PM | PM | J | J | J | J | J | E | |
| | | PM | PM | PM | PM | PM | PM | PM | K | K | K | F | K | F | |
| | | PM | PM | PM | PM | PM | PM | PM | N | G | N | N | N | G | |
| | | PM | PM | PM | PM | PM | PM | PM | S | H | S | S | S | H | |
| 3ACP + 4P + 24S | | | | | | | | | | | | | | | |

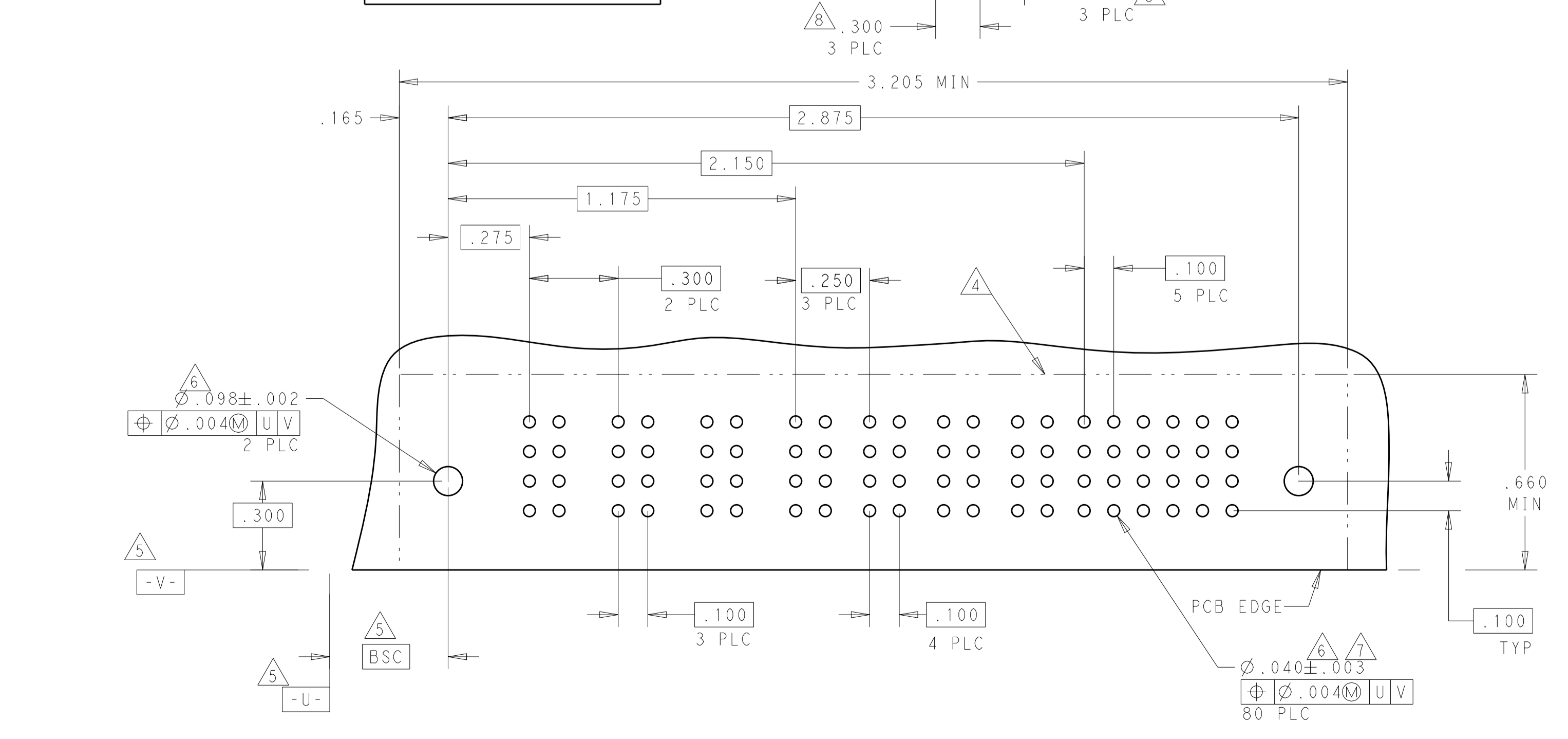

THIS DRAWING IS A CONTROLLED DOCUMENT.

| | | | | | |
|-----------------------|--|---|-----------------------------|---------|--|
| DIMENSIONS: INCHES | TOLERANCES UNLESS OTHERWISE SPECIFIED: 0 PLC ±. 1 PLC ±.01 2 PLC ±.01 3 PLC ±.005 4 PLC ±.0020 ANGLES ±.2° | DMN: R. GRZYBOWSKI CHK: M. PERCHERKE APVD: M. PERCHERKE | TOFEB05 TOFEB05 | | TE Connectivity |
| MATERIAL: | FINISH: | PRODUCT SPEC: 108-1973 | APPLICATION SPEC: 114-13038 | | NAME: RIGHT ANGLE HEADER ASSEMBLY W/GUIDES MULTI-BEAM XL |
| CUSTOMER DRAWING | | SCALE: 1:1 | SHEET 5 OF 11 | REV: E3 | |

| LOC | DIST | REV | DATE | BY | APPD |
|-------------|------|-------------|------|----|------|
| GP | 00 | - | - | - | - |
| REVISIONS | | | | | |
| DESCRIPTION | | SEE SHEET 1 | | | |

| PART NUMBER | ROWS | POWER | | | | | | | | | SIGNAL | | | | | |
|-----------------|------|-------|----|----|----|----|----|----|----|----|--------|---|---|---|---|---|
| | | P1 | P2 | P3 | P4 | P5 | P6 | P7 | P8 | P9 | 1 | 2 | 3 | 4 | 5 | 6 |
| I-6450132-9 | D | PM | PM | PM | PM | PM | PM | PM | PM | J | E | J | J | J | J | |
| | C | | | | | | | | | K | K | K | K | K | K | |
| | B | | | | | | | | | N | N | N | N | N | N | |
| | A | | | | | | | | | S | S | S | S | S | S | |
| 3ACP + 6P + 24S | | | | | | | | | | | | | | | | |

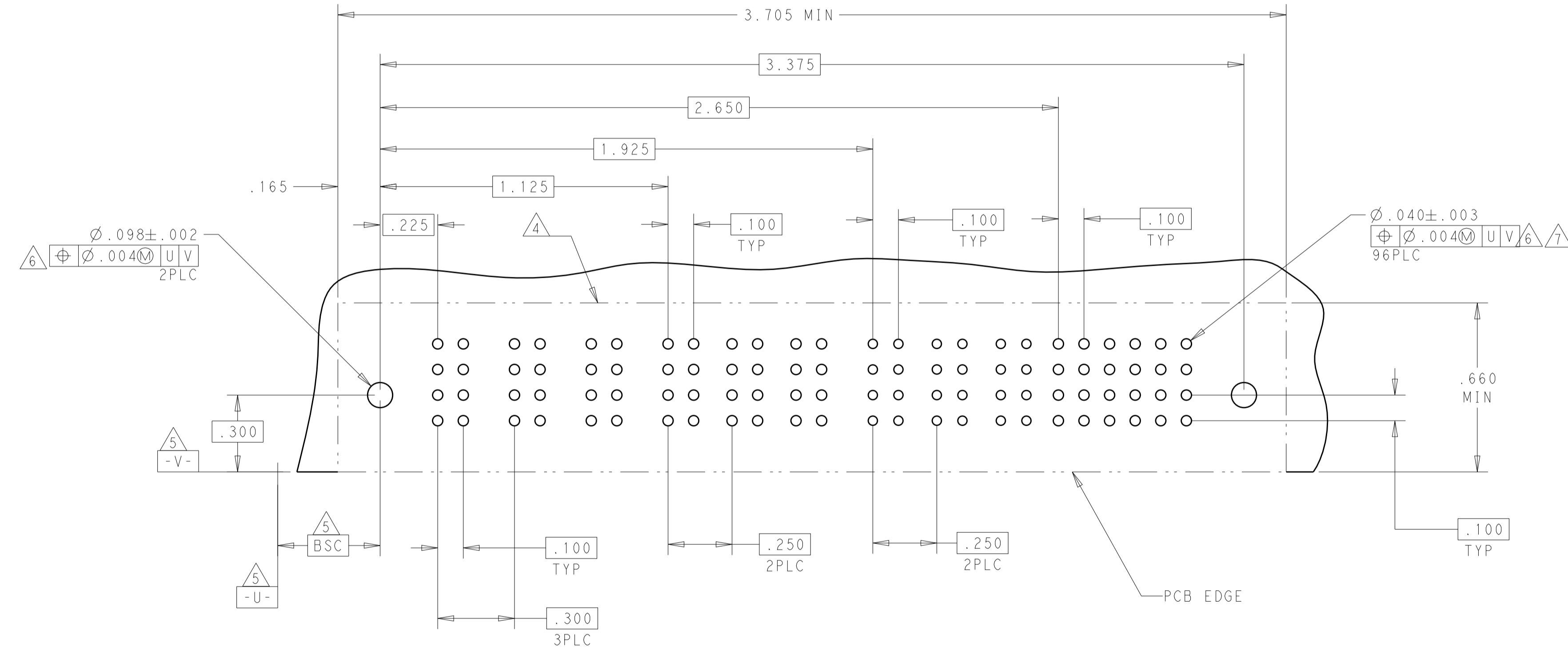
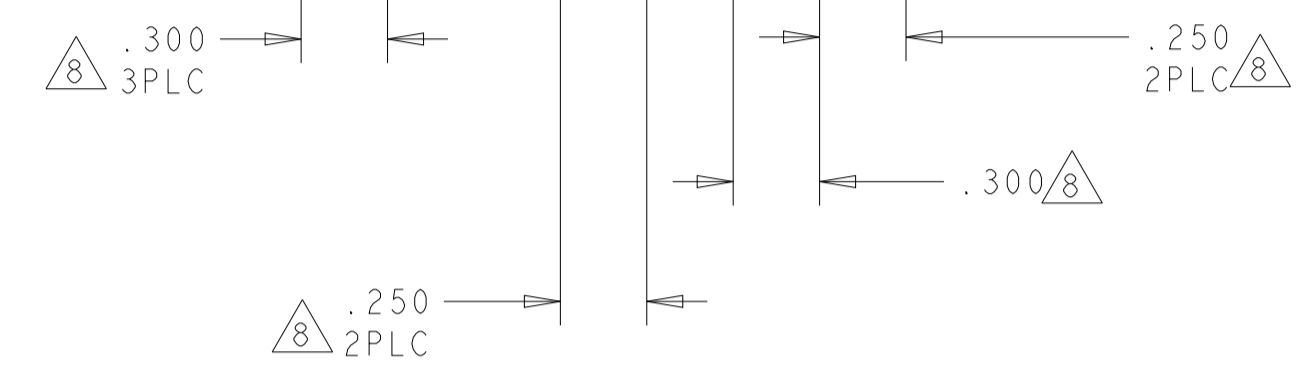

| DIMENSIONS: | | TOLERANCES UNLESS OTHERWISE SPECIFIED: | | MATERIAL: | | FINISH: | | APPROVALS: | | TE CONNECTIVITY | |
|------------------|---------|--|------------|-------------|--------------|---------|---------|------------|--------------|-----------------|--|
| INCHES | 0 PLC ± | 1 PLC ±.01 | 2 PLC ±.01 | 3 PLC ±.005 | 4 PLC ±.0020 | ANGLES | ±7° | APVD | M. PERCHERKE | NAME | RIGHT ANGLE HEADER ASSEMBLY W/GUIDES MULTI-BEAM XL |
| MATERIAL | | FINISH | | WEIGHT | 114-13038 | SIZE | A100779 | CAGE CODE | C=6450132 | REVISION | E3 |
| CUSTOMER DRAWING | | | | | | | | SCALE | 1:1 | SHEET | 7 OF 11 |

| LOC | DIST | REVISIONS | | | |
|-----|------|-------------|------|-----|------|
| P | LTN | DESCRIPTION | DATE | OWN | APVD |
| - | - | SEE SHEET 1 | - | - | - |

| PART NUMBER | ROWS | POWER | | | | | | SIGNAL | | | | | |
|-------------|------------------|-------|----|----|----|----|----|--------|---|---|---|---|---|
| | | P1 | P2 | P3 | P4 | P5 | P6 | 1 | 2 | 3 | 4 | 5 | 6 |
| 2-6450132-0 | D C B A | PM | PM | PM | PM | PM | PM | J | J | J | J | J | J |
| | | | | | | | | K | K | K | K | K | K |
| | | | | | | | | N | N | N | N | N | N |
| | | | | | | | | H | H | H | H | H | H |
| 6P + 24S | | | | | | | | | | | | | |

| PART NUMBER | ROWS | POWER | | | | | | | | | | SIGNAL | | | | | |
|-------------|------------------|-------|----|----|----|----|----|----|----|----|-----|--------|---|---|---|---|---|
| | | P1 | P2 | P3 | P4 | P5 | P6 | P7 | P8 | P9 | P10 | 1 | 2 | 3 | 4 | 5 | 6 |
| 2-6450132-1 | D C B A | PM | PM | PM | PM | PM | PM | PM | PM | PM | PM | J | E | J | J | J | E |
| | | | | | | | | | | | | K | F | K | K | K | F |
| | | | | | | | | | | | | N | N | N | N | N | G |
| | | | | | | | | | | | | S | S | S | S | S | H |
| 10P + 24S | | | | | | | | | | | | | | | | | |

| PART NUMBER | ROWS | POWER | | | | | | | | | | SIGNAL | | | | | |
|-------------|------------------|-------|----|----|----|----|----|----|----|----|-----|--------|---|---|---|---|---|
| | | P1 | P2 | P3 | P4 | P5 | P6 | P7 | P8 | P9 | P10 | 1 | 2 | 3 | 4 | 5 | 6 |
| 2-6450132-3 | D C B A | PM | PM | PM | PM | PM | PM | PM | PM | PM | PM | J | E | J | J | J | J |
| | | | | | | | | | | | | K | F | K | K | K | K |
| | | | | | | | | | | | | N | N | N | N | N | N |
| | | | | | | | | | | | | S | S | S | S | S | S |
| 10P + 24S | | | | | | | | | | | | | | | | | |

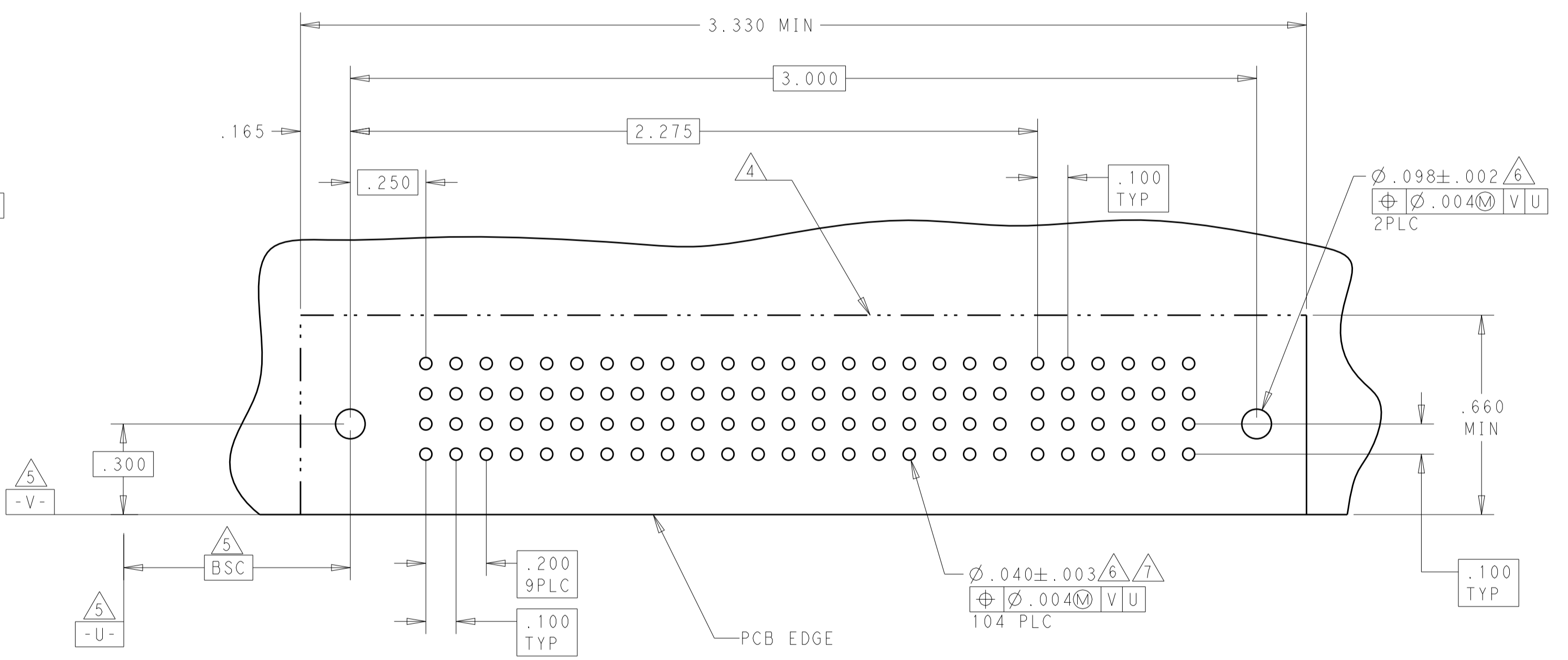
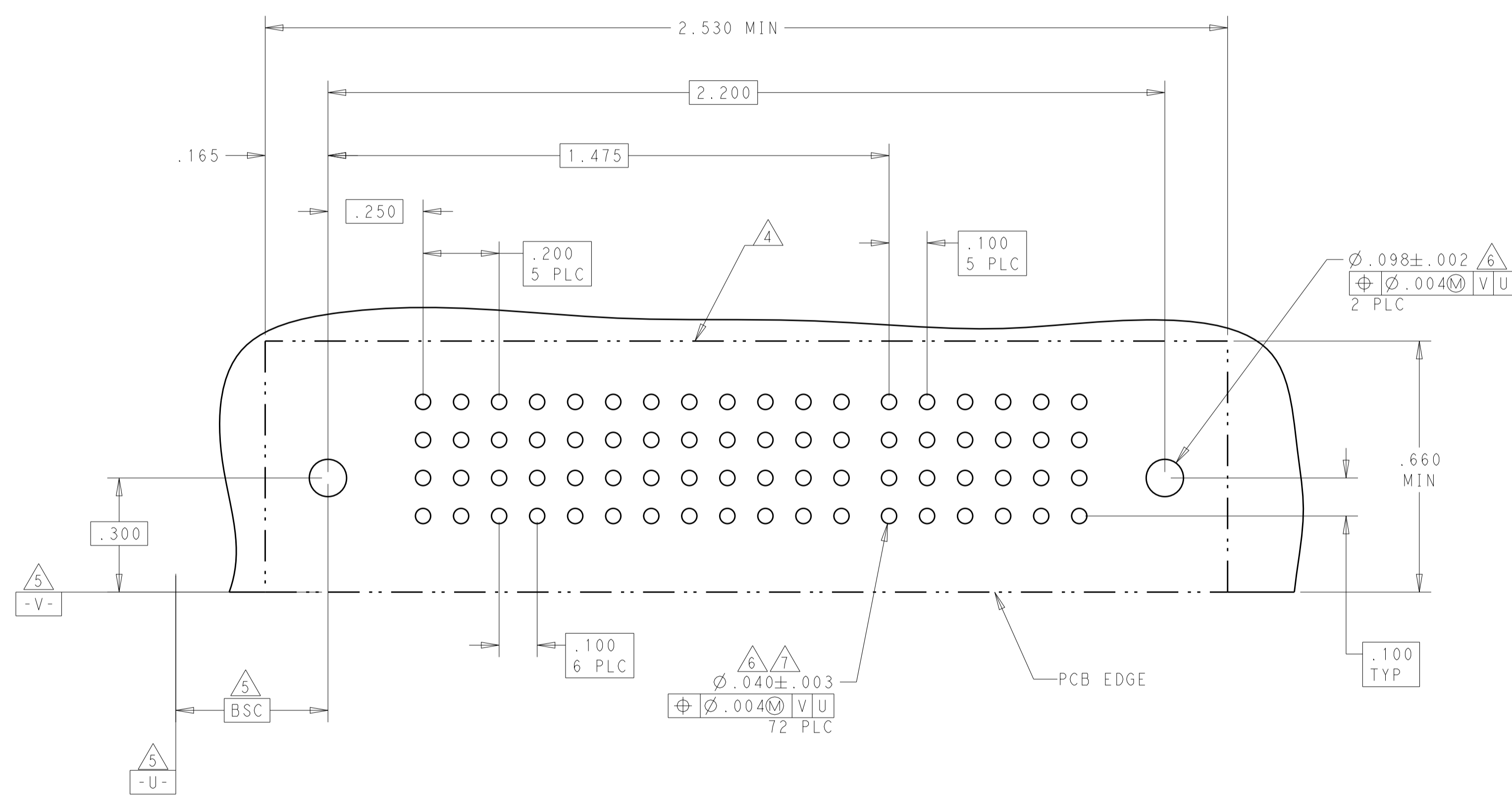

2-6450132-1 AND 2-6450132-3 PCB LAYOUT

| | | | | |
|--|--|---|--|---|
| THIS DRAWING IS A CONTROLLED DOCUMENT. | | OWN: R. GRZYBOWSKI CHK: M. PERCHERKE APVD: M. PERCHERKE | 10FEB05 10FEB05 | TE Connectivity |
| DIMENSIONS: INCHES | | TOLERANCES UNLESS OTHERWISE SPECIFIED: | NAME: RIGHT ANGLE HEADER ASSEMBLY W/GUIDES MULTI-BEAM XL | |
| 0 PLC ±. 1 PLC ±.01 2 PLC ±.01 3 PLC ±.005 4 PLC ±.002 ANGLES ±.020 | | FINISH: - | PRODUCT SPEC: 108-1973 APPLICATION SPEC: 114-13038 | SIZE: A1 CAGE CODE: 00779 DRAWING NO: C=6450132 |
| MATERIAL: - | | WEIGHT: - | CUSTOMER DRAWING | RESTRICTED TO: - SCALE: 1:1 SHEET 8 OF 11 REV: E3 |

| LOC | DIST | REVISIONS | | | | | |
|-----|------|-----------|-----|-------------|------|-----|------|
| GP | 00 | P | LYR | DESCRIPTION | DATE | DMN | APVD |
| - | - | - | - | SEE SHEET 1 | - | - | - |

| PART NUMBER | ROWS | POWER | | | | | | | | | | | | SIGNAL | | | | | |
|-------------|------------------|-------|----|----|----|----|----|----|----|----|-----|-----|-----|--------|---|---|---|---|---|
| | | P1 | P2 | P3 | P4 | P5 | P6 | P7 | P8 | P9 | P10 | P11 | P12 | 1 | 2 | 3 | 4 | 5 | 6 |
| 2-6450132-2 | D C B A | PM | PM | PM | PM | PM | PM | PM | PM | PM | PM | PM | PM | E | J | J | J | J | E |
| | | PM | PM | PM | PM | PM | PM | PM | PM | PM | PM | PM | PM | K | K | K | K | K | K |
| | | PM | PM | PM | PM | PM | PM | PM | PM | PM | PM | PM | PM | N | N | N | N | N | N |
| | | PM | PM | PM | PM | PM | PM | PM | PM | PM | PM | PM | PM | S | S | S | S | S | S |

| PART NUMBER | ROWS | POWER | | | | | | | | | | SIGNAL | | | | | |
|-------------|------------------|-------|----|----|----|----|----|----|----|----|-----|--------|---|---|---|---|---|
| | | P1 | P2 | P3 | P4 | P5 | P6 | P7 | P8 | P9 | P10 | 1 | 2 | 3 | 4 | 5 | 6 |
| 2-6450132-4 | D C B A | PM | PM | PM | PM | PM | PM | PM | PM | PM | PM | J | E | J | J | J | E |
| | | PM | PM | PM | PM | PM | PM | PM | PM | PM | PM | K | F | K | K | K | F |
| | | PM | PM | PM | PM | PM | PM | PM | PM | PM | PM | N | N | N | N | N | G |
| | | PM | PM | PM | PM | PM | PM | PM | PM | PM | PM | S | S | S | S | S | H |

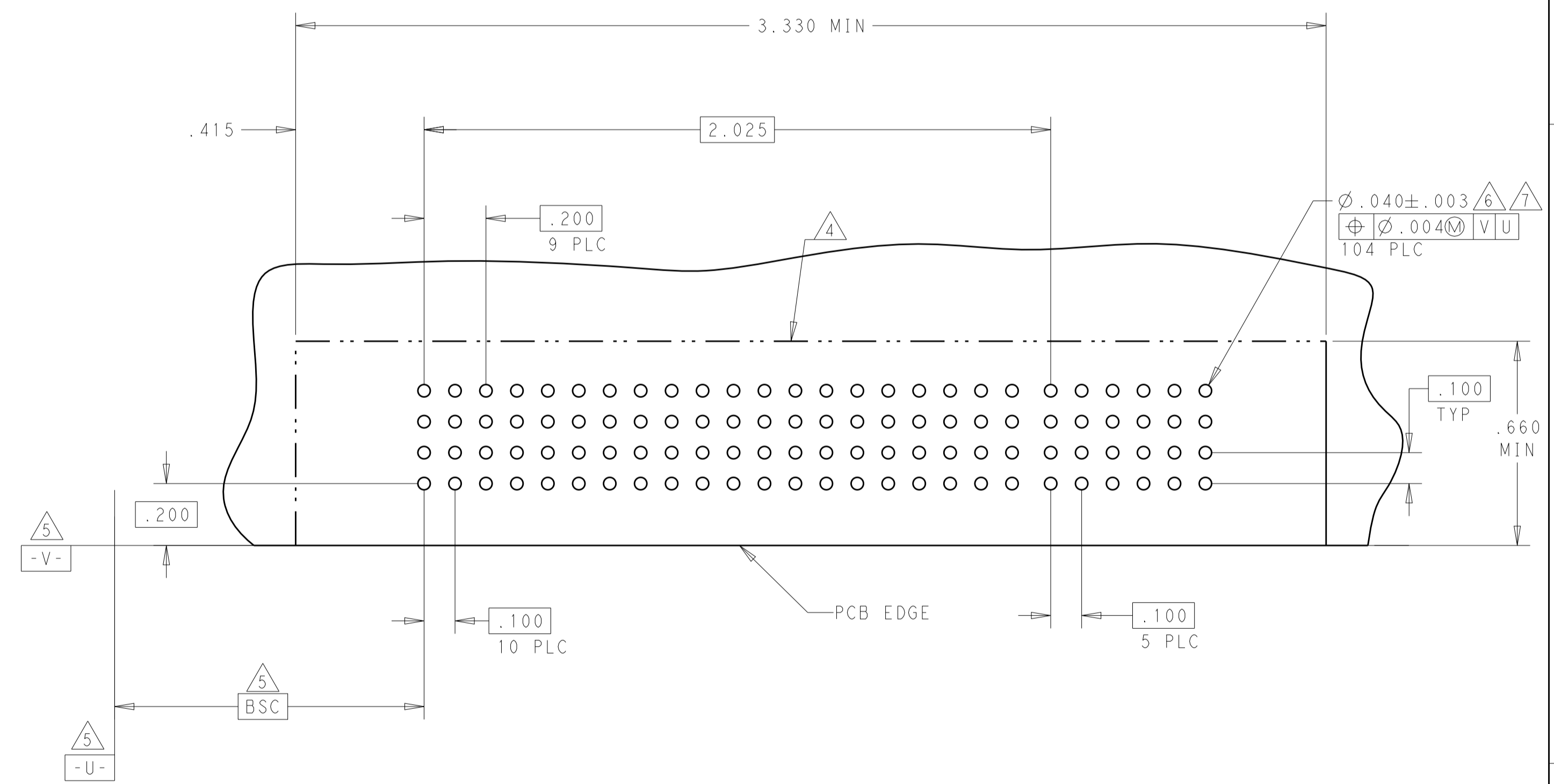
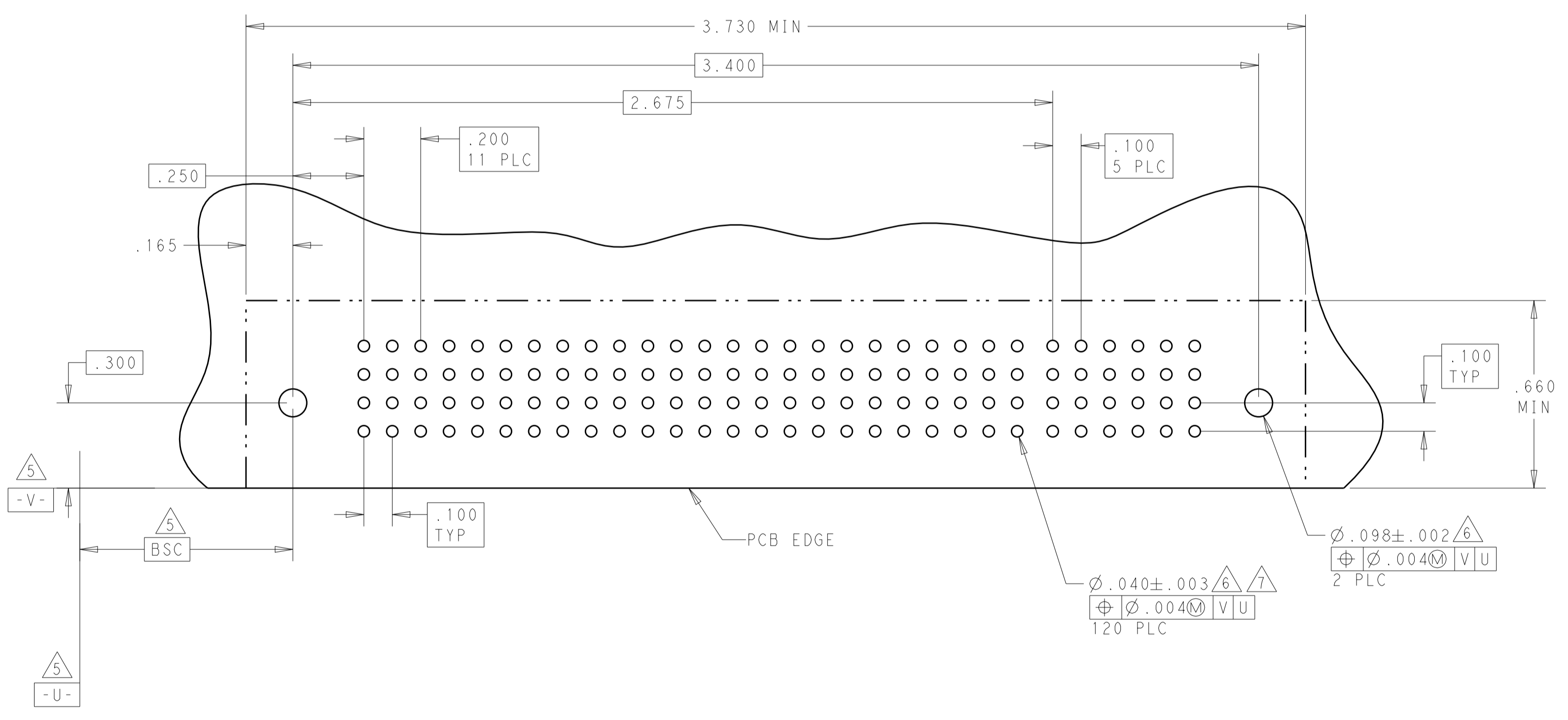

| | | | | | | |
|--|--|-----------------------------|---------|--|--|--|
| THIS DRAWING IS A CONTROLLED DOCUMENT. | | DMN: R. GRZYBOWSKI | TOFEB05 | | TE Connectivity | |
| DIMENSIONS: INCHES | | CHK: M. PERCHERKE | TOFEB05 | | RIGHT ANGLE HEADER ASSEMBLY W/GUIDES MULTI-BEAM XL | |
| TOLERANCES UNLESS OTHERWISE SPECIFIED: | | APVD: M. PERCHERKE | | NAME: RIGHT ANGLE HEADER ASSEMBLY W/GUIDES MULTI-BEAM XL | | |
| 0 PLC ±.01 | | PRODUCT SPEC: 108-1973 | | SIZE: CAGE CODE: DRAWING NO: 114-13038 | | |
| 1 PLC ±.01 | | APPLICATION SPEC: 114-13038 | | RESTRICTED TO: A100779 | | |
| 2 PLC ±.01 | | WEIGHT: - | | SCALE: 1:1 SHEET 9 OF 11 REV: E3 | | |
| 3 PLC ±.005 | | | | CUSTOMER DRAWING | | |
| 4 PLC ±.0020 | | | | | | |
| ANGLES: ±.7° | | | | | | |
| FINISH: - | | | | | | |

| LOC | DIST | REVISIONS | | | | | |
|-----|------|-----------|-----|-------------|------|-----|------|
| GP | 00 | P | LTN | DESCRIPTION | DATE | DMN | APVD |
| - | - | - | - | SEE SHEET 1 | - | - | - |

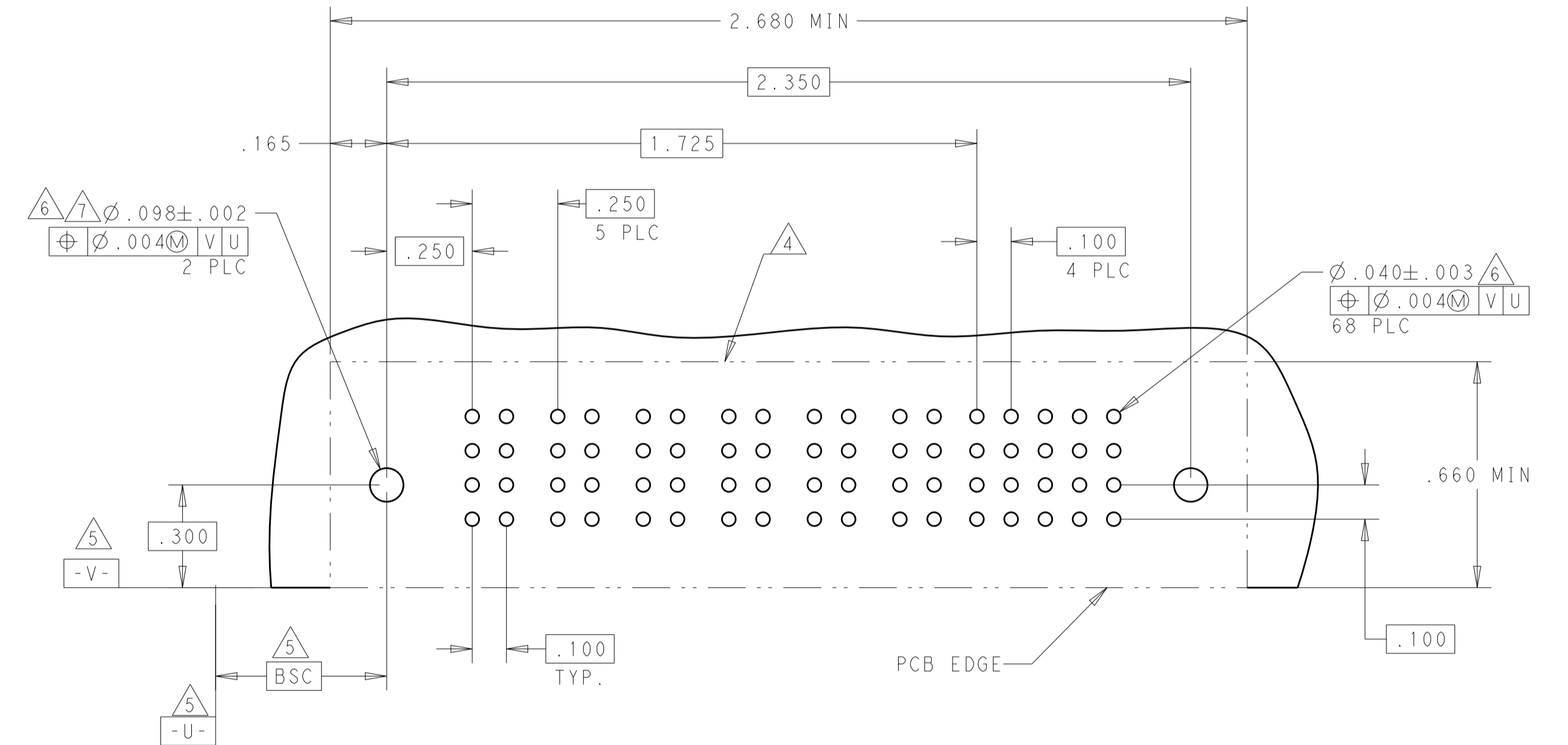
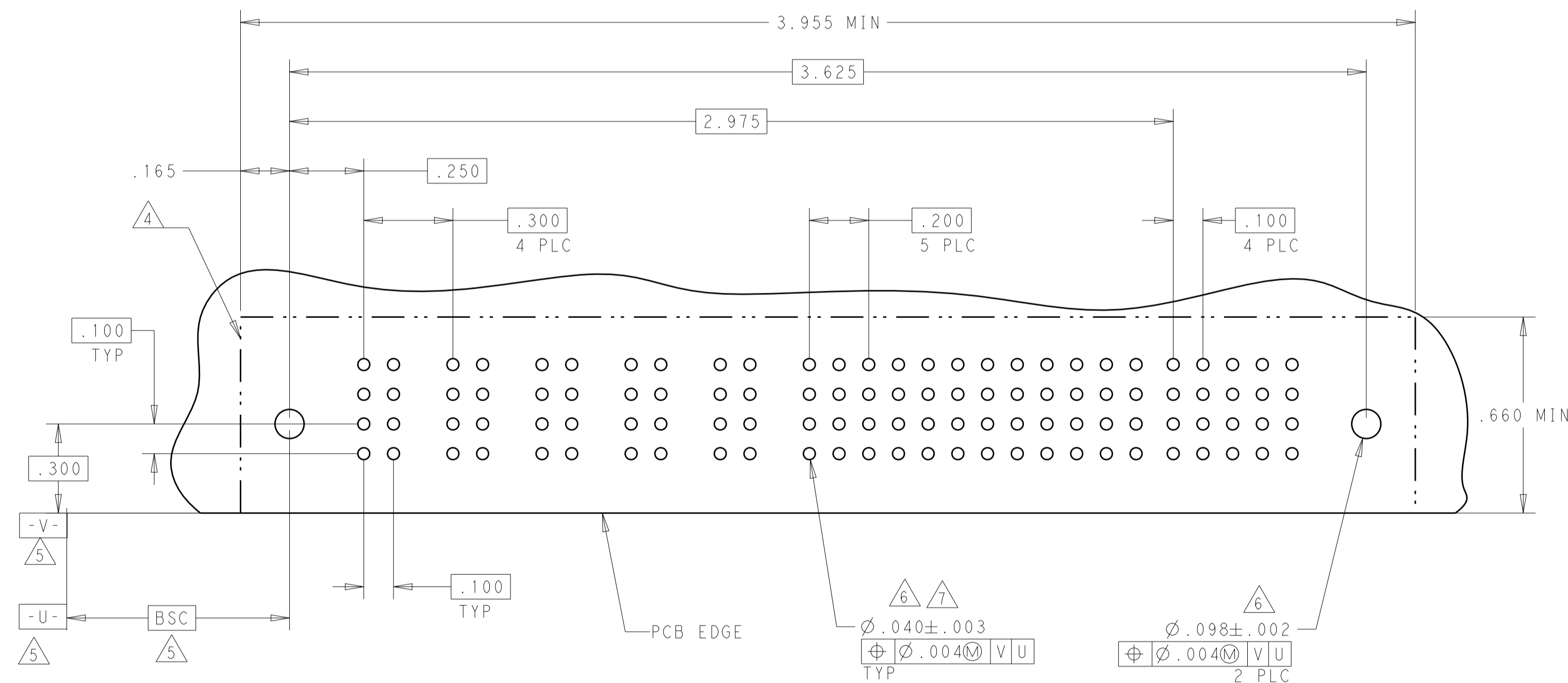
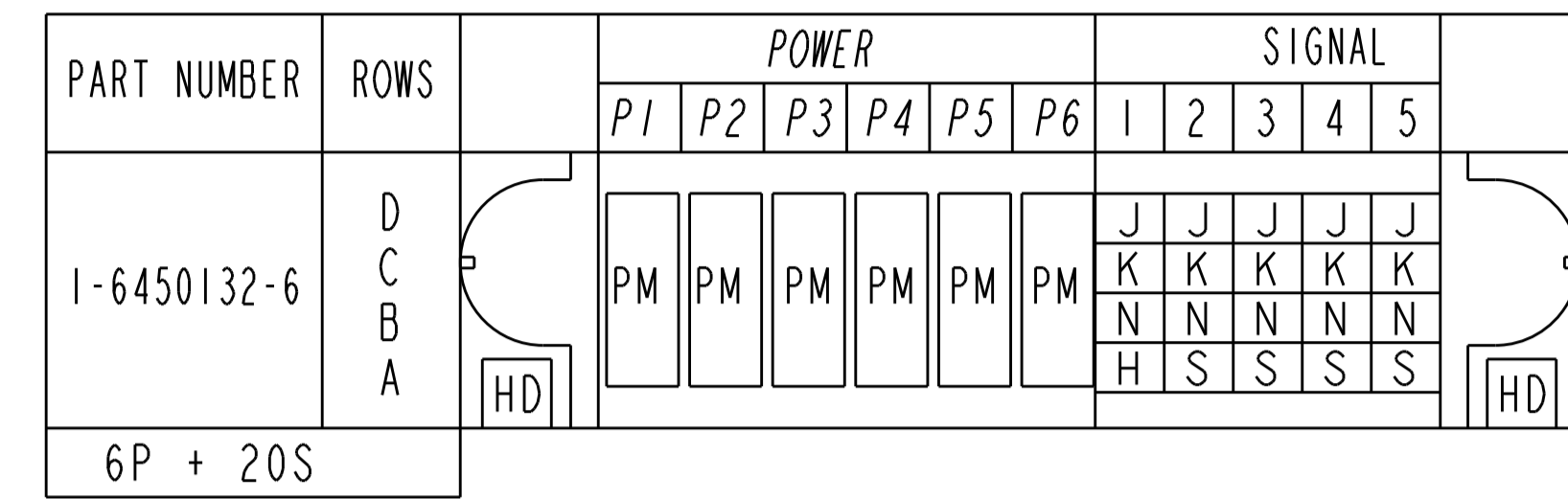
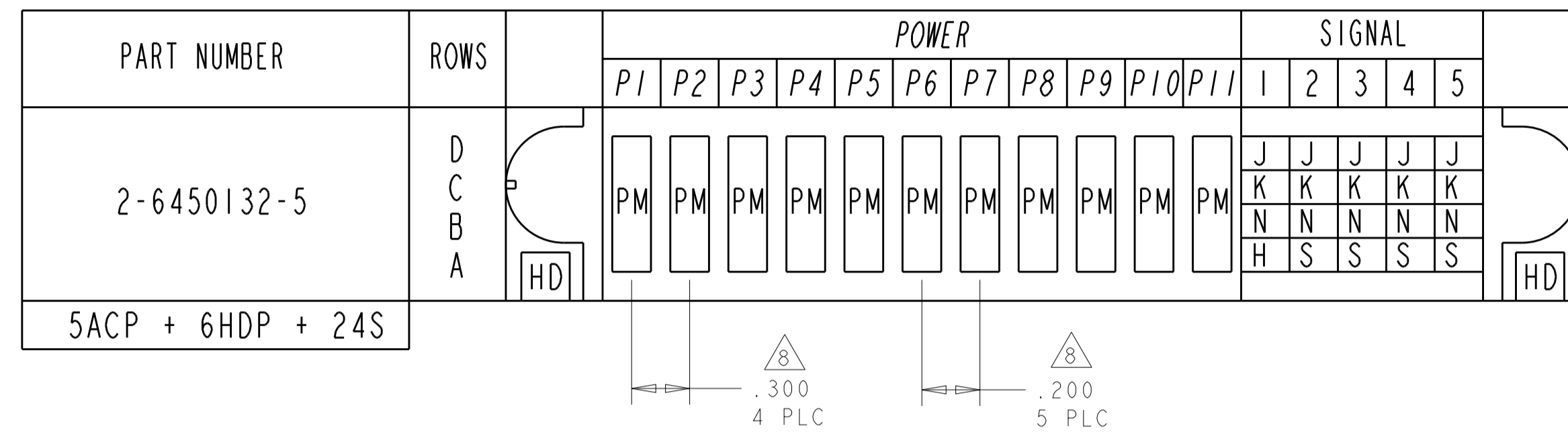

| | | | | |
|--|---------|------------------------|-----------------------------|---|
| THIS DRAWING IS A CONTROLLED DOCUMENT. | | DMN: R. GRZYBOWSKI | 10FEB05 | TE Connectivity |
| DIMENSIONS: INCHES | | CHK: M. PERCHERKE | 10FEB05 | |
| TOLERANCES UNLESS OTHERWISE SPECIFIED: | | APVD: M. PERCHERKE | | NAME: RIGHT ANGLE HEADER ASSEMBLY W/GUIDES MULTI-BEAM XL |
| 0 PLC ±. 1 PLC ±.01 2 PLC ±.01 3 PLC ±.005 4 PLC ±.0020 ANGLES ±.2° | | PRODUCT SPEC: 108-1973 | APPLICATION SPEC: 114-13038 | |
| MATERIAL: | FINISH: | WEIGHT: | SIZE: A100779 | RESTRICTED TO: |
| CUSTOMER DRAWING | | SCALE: 1:1 | SHEET 10 OF 11 | REV: E3 |

| LOC | DIST | REVISIONS | | | |
|-----|------|-------------|------|-----|------|
| P | LTH | DESCRIPTION | DATE | DWN | APVD |
| - | - | SEE SHEET 1 | - | - | - |
| | | | | | |
| | | | | | |

| PART NUMBER | ROWS | POWER | | | | | | | | | | | | | SIGNAL | | | | | | | |
|-------------|------|-------|----|----|----|----|----|----|----|----|-----|-----|-----|-----|--------|---|---|---|---|---|---|---|
| | | P1 | P2 | P3 | P4 | P5 | P6 | P7 | P8 | P9 | P10 | P11 | P12 | P13 | 1 | 2 | 3 | 4 | 5 | 6 | 7 | 8 |
| 2-6450132-7 | D | PM | PM | PM | PM | PM | PM | PM | PM | PM | PM | PM | PM | J | J | J | J | J | J | J | E | |
| | C | PM | PM | PM | PM | PM | PM | PM | PM | PM | PM | PM | PM | K | K | K | K | K | K | K | F | |
| | B | PM | PM | PM | PM | PM | PM | PM | PM | PM | PM | PM | PM | N | N | N | N | N | N | N | G | |
| | A | PM | PM | PM | PM | PM | PM | PM | PM | PM | PM | PM | PM | S | S | S | S | S | S | S | H | |

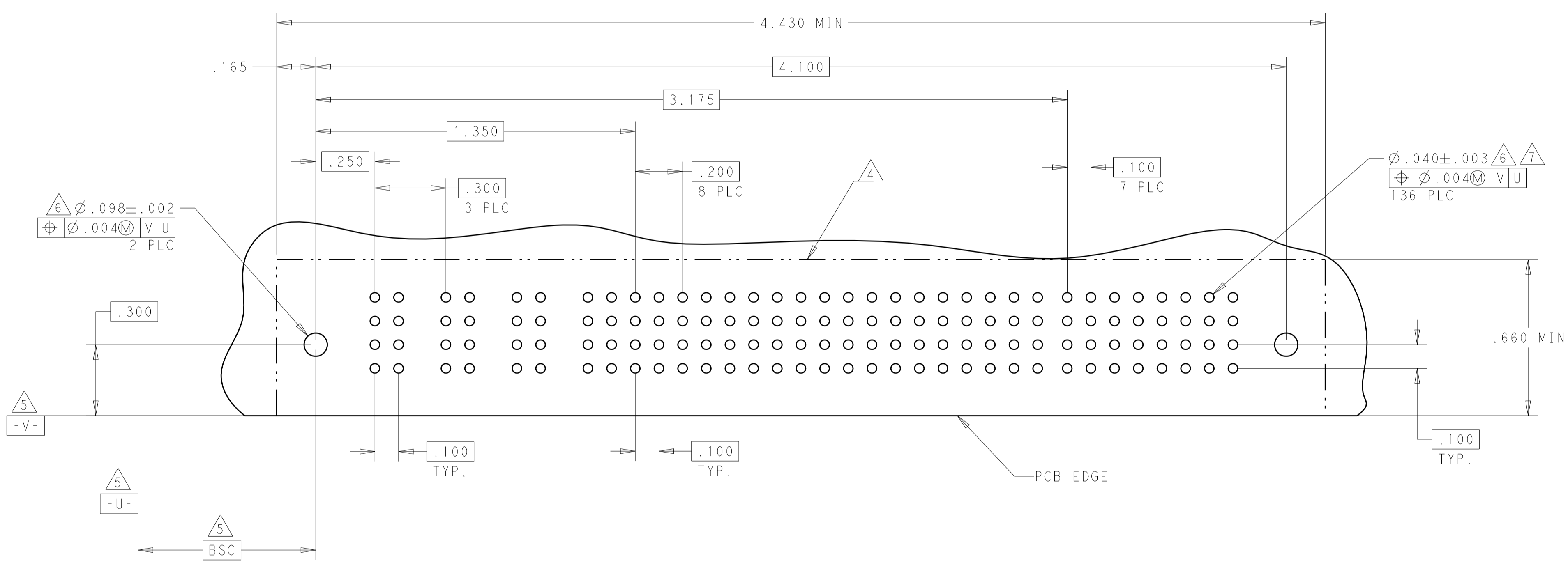
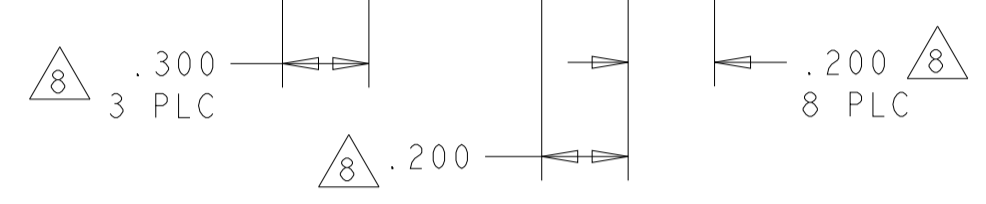

THIS DRAWING IS A CONTROLLED DOCUMENT. DWN: R. GRZYBOWSKI 10FEB05
 CHK: M. PERCHERKE 10FEB05

TE CONNECTIVITY

RIGHT ANGLE HEADER ASSEMBLY W/GUIDES MULTI-BEAM XL

APVD: M. PERCHERKE

PRODUCT SPEC: 108-1973
 APPLICATION SPEC: 114-13038

SIZE: 114-13038
 WEIGHT: -

MATERIAL: -
 FINISH: -

CUSTOMER DRAWING

SCALE: 1:1 SHEET 11 OF 11 REV: E3