

# MINI-BEAM® MIAD9 NAMUR Series Sensor



## Datasheet

No revision without agency approval.

To view or download the latest technical information about this product, including specifications, dimensions, accessories, and wiring, go to [www.bannerengineering.com](http://www.bannerengineering.com).



- Designed for use with approved amplifiers and intrinsically safe barriers in explosive environments
- NAMUR compliant sensors with MINI-BEAM performance and small size
- Output 1 mA or less in the dark condition and 2 mA or more in the light condition
- Models with integral cable or quick-disconnect



### WARNING:

- **Do not use this device for personnel protection**
- Using this device for personnel protection could result in serious injury or death.
- This device does not include the self-checking redundant circuitry necessary to allow its use in personnel safety applications. A device failure or malfunction can cause either an energized (on) or de-energized (off) output condition.

## Models

Model <sup>1</sup>	Sensing Mode	Sensing Beam	Sensing Range	Output Type
MI9E	Opposed (Emitter)	Infrared, 880 nm	6 m (20 ft)	Constant Current ≤ 1.2 mA dark ≥ 2.1 mA light
MIAD9R	Opposed (Receiver)			
MIAD9LVAG	Polarized Retroreflective	Visible red, 650 nm	50 mm to 2 m (2 in to 7 ft)	
MIAD9LV	Retroreflective	Visible red, 650 nm	5 m (16.4 ft)	
MIAD9D	Diffuse	Infrared, 880 nm	380 mm (15 in)	
MIAD9W	Divergent Diffuse	Infrared, 880 nm	75 mm (3 in)	
MIAD9CV	Convergent	Visible red, 650 nm	16 mm (0.6 in)	
MIAD9CV2			43 mm (1.7 in)	
MIAD9F	Fiber Optic (Glass)	Infrared, 880 nm	Range varies by sensing mode and fiber optics used	

## Overview

MIAD9 Series NAMUR Sensors are small, rugged, self-contained two-wire sensors designed for use with certified intrinsically safe switching amplifiers and barriers (Approved Apparatus) with intrinsically safe circuits. MIAD9 Series NAMUR sensors are designed in accordance with DIN 19234 (IEC/EN 60947-5-6) for operation via two-wire connection to an Approved Apparatus that is controlled by the variable internal resistance of the sensor.

These sensors vary the impedance across the sensor output, which passes 1 mA or less in the “dark” condition and 2 mA or more in the “light” condition. A red LED on the rear of the sensor lights whenever the sensor sees the “light” condition. A rugged, clutched, 15-turn slotted brass screw Gain control potentiometer enables precise adjustment of system sensitivity.

Models are available with either a 2 m (6.5 ft) or 9 m (30 ft) long attached PVC-covered cable, or a 4-pin Euro-style quick disconnect (QD) connector. Quick disconnect models (with “Q” in the model number suffix) use **MQD9-4..** mating cable (either straight or right angle connector; see [Quick-Disconnect \(QD\) Cables](#) on p. 8). Contact Banner Engineering for availability of sensor models with 9 m (30 ft) long attached cable.

Figure 1. Features (rear of sensor, quick-disconnect model shown)

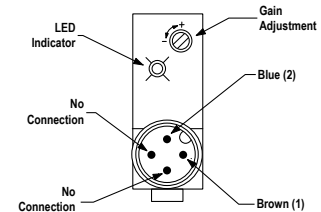

<sup>1</sup> Only standard 2 m (6.5 ft) cable models are listed. For 4-pin M12/Euro-style Integral QD models: add suffix “Q” to the model number (for example, **MIAD9RQ**); accessory mating cable required.



## Installation Instructions

---

### Ex/HazLoc Applications



**WARNING:**

- **Explosive Atmospheres/Hazardous Locations**
- It is the user's responsibility to ensure that all local, state, and national laws, rules, codes, or regulations relating to the installation and use of this device in any particular application are satisfied. This device must be installed by a Qualified Person<sup>2</sup>, in accordance with this document and applicable regulations.



**WARNING:**

- **Explosion Hazard**
- Do not disconnect equipment unless the power has been switched off or the area is known to be non-hazardous.



**CAUTION:**

- **Electrostatic Discharge (ESD) Special Conditions for Safe Use**
- Parts of the enclosure are non-conducting and can generate an ignition-capable level of ESD.
- Clean the equipment with only a damp cloth.

#### General Notes and Conditions for Use:

- See Specifications and Wiring Diagrams for important information concerning entity parameters, permissible locations, electrical connections and certifications.
- In addition to the warning above concerning user responsibility, the installation must comply with the following:
  - All installations must comply with all manufacturer's instructions.
  - U.S. Installations: The relevant requirements of the National Electrical Code® (ANSI/NFPA-70 (NEC®) and when appropriate ANSI/ISA-RP12.06.01 Installation of Intrinsically Safe Systems for Hazardous (Classified) Locations.
  - Canadian Installations: The relevant requirements of the Canadian Electrical Code (CSA C22.1).
  - ATEX and IECEx Installations: The relevant requirements of EN 60079-14 and applicable National regulations.
  - For quick disconnect (QD) models only: Use Banner **MQD9-4##** cordsets (see [Quick-Disconnect \(QD\) Cables](#) on p. 8), or suitable M12 quick disconnect cordsets with threaded retaining nut (see [Specifications](#) on p. 3), The cordset must be securely fastened using the M12x1 QD retaining nut to prevent disconnection. Maximum connector torque: 6 ft-lbs.
- Do not attempt any repairs to this device; it contains no field-replaceable parts or components. Tampering and/or replacement with non-factory components may adversely affect the safe use of the system.
- Approved Apparatus entity parameters must meet the following requirements:
  - $V_{oc} \text{ or } V_t \leq V_{max}$
  - $C_a \geq C_i + C_{cable}$
  - $I_{sc} \text{ or } I_t \leq I_{max}$
  - $L_a \geq L_i + L_{cable}$
- Sensor Entity Parameters:
  - $V_{max} (U_i) \leq 15 \text{ V DC}$
  - $I_{max} (I_i) \leq 60 \text{ mA}$
  - $P_i \leq 225 \text{ mW}$
  - $C_i = 0.3 \mu\text{F}$
  - $L_i = 0 \text{ mH}$
- Cable Entity Parameters (if unknown):
  - $C_{cable} = 60 \text{ pF/ft}$
  - $L_{cable} = 0.2 \mu\text{H/ft}$
- The ambient operating temperature range of the Sensors is  $-40 \text{ }^\circ\text{C}$  to  $+70 \text{ }^\circ\text{C}$  ( $-40 \text{ }^\circ\text{F}$  to  $+158 \text{ }^\circ\text{F}$ ).
- For U.S. installations, Class II and III, Division 2 applies only to model numbers ending in a Q suffix.
- For intrinsically safe installations, sensors must be used with certified intrinsically safe switching amplifiers and barriers (Approved Apparatus) with intrinsically safe circuits that limit supply voltage and current in the event of failures.
- Associated Apparatus is not required for installation of the devices within a Division 2 hazardous (classified) location when installed per the National Electrical Code. The maximum voltage for Division 2 installation is 15 V DC. In Division 2 installations (without Associated Apparatus), observe Explosion Hazard warning at the beginning of this section.
- Associated Apparatus is not required for installation of the devices within a Division 2 hazardous (classified) location when installed in, or through the wall of a suitable enclosure with provision for connection of rigid metal conduit per the Canadian Electrical Code, as acceptable to the local inspection authority having jurisdiction. The maximum rating for Division 2 installation is 15 V DC, 60 mA. In Division 2 installations (without Associated Apparatus), observe Explosion Hazard warning at the beginning of this section.
- Maximum non-hazardous area voltage that the Approved Apparatus (intrinsically safe circuit) is connected to must not exceed 250 V.

<sup>2</sup> A Qualified Person is a person who, by possession of a recognized degree or certificate of professional training, or who, by extensive knowledge, training and experience, has successfully demonstrated the ability to solve problems relating to the subject matter and work.

- Intrinsic safety ground, if required for the Associated Apparatus, shall be less than 1 ohm.

## Wiring Connections

MIAD9 Series NUMAR sensors are intrinsically safe ONLY when used with certified intrinsically safe switching amplifiers and barriers (Approved Apparatus) with intrinsically safe circuits.

Banner does not manufacture such devices; however, our applications engineers can refer you to suppliers of certified devices that will interface with Banner sensors.

The user is responsible for proper installation and maintenance of this equipment, and must conform with the certification requirements relating to barriers and to maximum allowable capacitance and inductance of the field wiring. If in doubt about these requirements, our applications engineers can refer you to the appropriate authority.

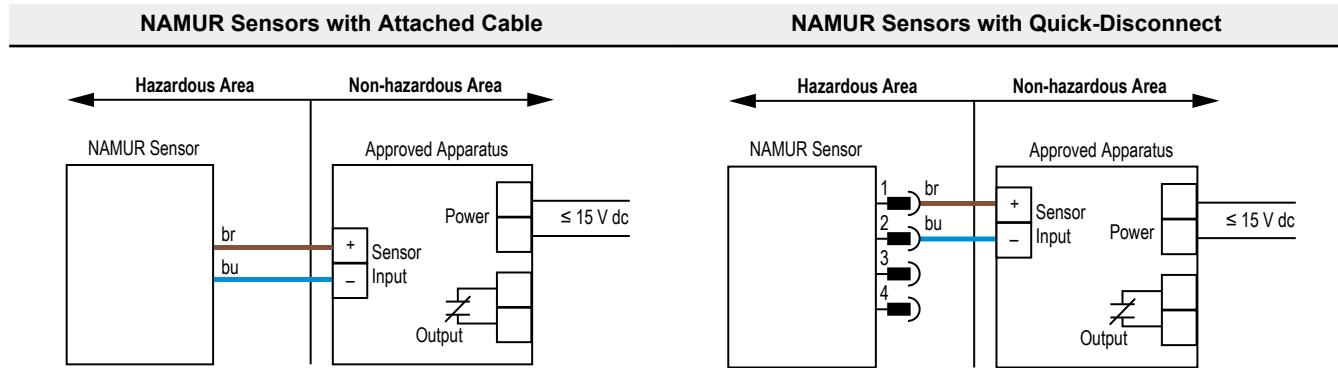

## Specifications

### Supply Voltage and Current

5 to 15 V DC (provided by the amplifier to which the sensor is connected)

### Output

Constant current output:  $\leq 1.2$  mA in the "dark" condition and  $\geq 2.1$  mA in the "light" condition

### Output Response Time

**Opposed mode:** 2 ms ON/400  $\mu$ s OFF

**All other modes:** 5 ms ON/OFF (does not include amplifier response)

### Adjustments

15-turn slotted brass screw GAIN (sensitivity) adjustment potentiometer (clutched at both ends of travel); located on rear panel and protected by a clear gasketed acrylic cover

### Indicators

Red LED Alignment Indicator Device (AID) located on rear panel lights when the sensor sees a "light" condition; pulse rate is proportional to signal strength (the stronger the signal, the faster the pulse rate).

### Construction

Reinforced thermoplastic polyester housing, totally encapsulated, o-ring sealing, acrylic lenses, and stainless steel screws

### Connections

PVC-jacketed 2-conductor 2 m or 9 m cables, or special 4-pin M12 quick-disconnect (QD) fitting are available; QD cables are ordered separately. Connecting 4-pin M12 QD Cordsets (see [Quick-Disconnect \(QD\) Cables](#) on p. 8): Female single-ended Multiconductor cable (at minimum): UL Style 2517, 24 AWG wire, rated  $\geq 80$  °C; M12 QD connector: per IEC 61076-2-101, must have threaded M12  $\times$  1 retaining nut.

### Application Note

Special Conditions for Safe Use: Parts of the enclosure are non-conducting and may generate an ignition-capable level of ESD. Cleaning of the equipment must be done only with a damp cloth.

### Environmental Rating

Banner tested to NEMA standards 1, 2, 3, 3S, 4, 4X, 6, 12, and 13 IP67

### Operating Conditions

-40 °C to +70 °C (-40 °F to +158 °F)

### Certifications



**Banner Engineering Europe** Park Lane, Culliganlaan 2F bus 3, Diegem B-1831 BELGIUM



**Turck Banner LTD** Blenheim House, Blenheim Court, Wickford, Essex SS11 8YT, Great Britain



IEC IECEx FMG 14.0029X  
ATEX FM12ATEX0094X  
FM21UKEX0211X  
FM20US0068X CoC 0003046293 (US)  
FM20CA0032X CoC 0003046293C (CAN)  
CCC 2020012315326661

Design Standards	
ATEX (European)	EN IEC 60079-0, EN 60079-11
Canada	CAN/CSA C22.2: No.0-M91, No.142-M1987, No.157-92, No.213-M1987, No.1010.1, E60079-0 and E60079-11
United States	FM Class 3600, 3610, and 3810; ANSI/ISA 61010-1 (82.02.01), 60079-0 and 60079-11
IECEX	IEC 60079-0, IEC 60079-11

Approvals	
<b>MIAD9(a)(b), MI9E(b)</b>	a = Sensing mode D, W, F, LV, LVAG, CV, CV2 or R. b = Connection method Q or blank.
ATEX (European)	II 1 G Ex ia IIC T5 Ga Ta = -40°C to 70°C - 39616; Entity Entity Parameters: U <sub>i</sub> = 15 V dc, I <sub>i</sub> = 60 mA, P <sub>i</sub> = 225 mW, C <sub>i</sub> = 0.3 µF, L <sub>i</sub> = 0 mH.
Canadian	IS / I,II,III / 1 / ABCDEFG / T5 Ta = -40°C to 70°C - 39616; Entity I / 0 / Ex ia / IIC / T5 Ta = -40°C to 70°C - 39616; Entity (Non-incendive) NI / I / 2 / ABCD / T5 Ta = -40°C to 70°C Entity Parameters: V <sub>Max</sub> = 15 V dc, I <sub>Max</sub> = 60 mA, P <sub>i</sub> = 225 mW, C <sub>i</sub> = 0.3 µF, L <sub>i</sub> = 0 mH
United States	IS / I,II,III / 1 / ABCDEFG / T5 Ta = -40°C to 70°C - 39616; Entity I / 0 / AEx ia / IIC / T5 / Ga Ta = -40°C to 70°C - 39616; Entity (Non-incendive) NI / I / 2 / ABCD / T5 Ta = -40°C to 70°C S / II,III / 2 / FG* / T5 Ta = -40°C to 70°C *Class II and III, Division 2 applies only to model numbers ending in a Q suffix. Entity Parameters: V <sub>Max</sub> = 15 V dc, I <sub>Max</sub> = 60 mA, P <sub>i</sub> = 225 mW, C <sub>i</sub> = 0.3 µF, L <sub>i</sub> = 0 mH
IECEX	Ex ia IIC T5 Ga Ta = -40 °C to +70 °C - 35331; Entity Entity Parameters: U <sub>i</sub> = 15 V dc, I <sub>i</sub> = 60 mA, P <sub>i</sub> = 225 mW, C <sub>i</sub> = 0.3 µF, L <sub>i</sub> = 0 mH.

  
2809



II 1 G  
 Ex ia IIC T5 Ga  
 Ta = -40°C to +70°C  
 FM12ATEX0094X  
 IECEx FMG 14.0029X

  
1725

  
APPROVED

FM21UKEX0211X  
 FM20US0068X  
 FM20CA0032X  
 CL I/II/III Div 1  
 Groups ABCDEFG T5  
 CL I Zn 0 AEx ia IIC T5 Ga

  
KGS

15-GA4BO-0491X  
 Ex ia IIC T5

Banner Engineering Corp.  
 9714 Tenth Ave. N.  
 Mpls, MN 55441 USA

Banner Eng. Europe  
 Park Ln., Culliganlann 2F  
 Diegem BE 1831

**INSTALL PER DWG 39616**

### Performance Curves

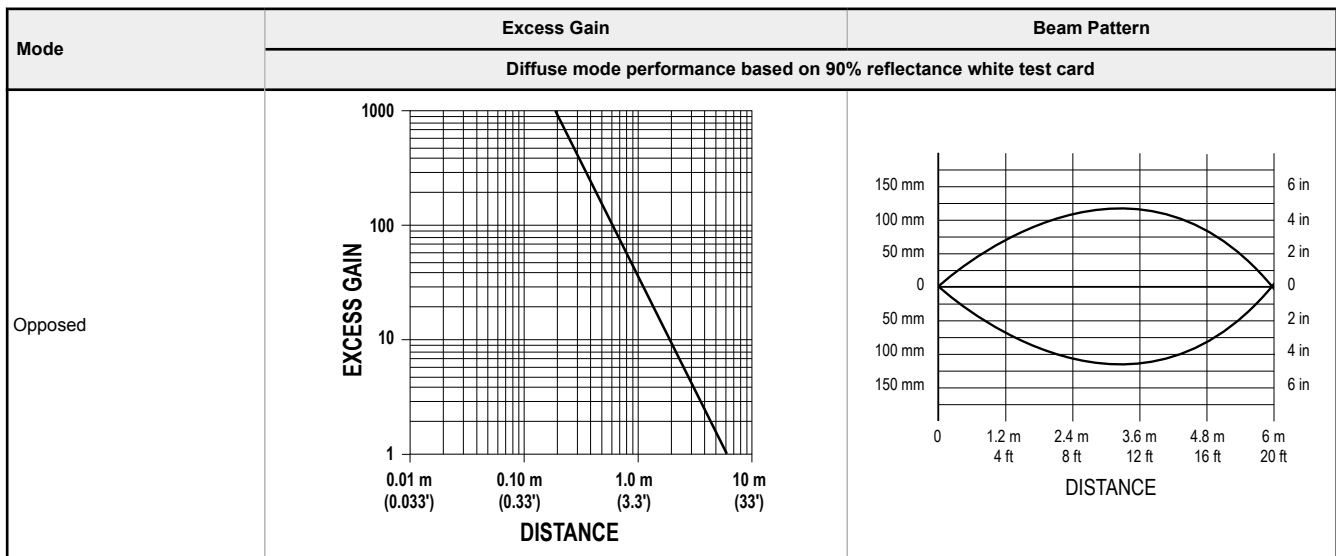

Mode	Excess Gain	Beam Pattern
	Diffuse mode performance based on 90% reflectance white test card	
Polarized Retroreflective		
Retroreflective		
Diffuse		

Mode	Excess Gain	Beam Pattern
	Diffuse mode performance based on 90% reflectance white test card	
Divergent Diffuse	<p>Graph showing Excess Gain (log scale, 1 to 1000) versus Distance (log scale, 0.01 mm to 100 mm). The curve peaks at approximately 40 at 10 mm.</p>	<p>Graph showing Beam Pattern (mm) versus Distance (mm). The beam diameter increases from 0 at 0 mm to approximately 12 mm at 50 mm, then decreases to 0 at 100 mm.</p>
Convergent 16 mm (0.6 in)	<p>Graph showing Excess Gain (log scale, 1 to 1000) versus Distance (log scale, 0.1 mm to 100 mm). The curve peaks at approximately 15 at 16 mm.</p>	<p>Graph showing Beam Pattern (mm) versus Distance (mm). The beam diameter increases from 0 at 0 mm to approximately 1.5 mm at 16 mm, then decreases to 0 at 32 mm.</p>
Convergent 43 mm (1.7 in)	<p>Graph showing Excess Gain (log scale, 1 to 1000) versus Distance (log scale, 1 mm to 1000 mm). The curve peaks at approximately 8 at 43 mm.</p>	<p>Graph showing Beam Pattern (mm) versus Distance (mm). The beam diameter increases from 0 at 0 mm to approximately 1.5 mm at 43 mm, then decreases to 0 at 86 mm.</p>

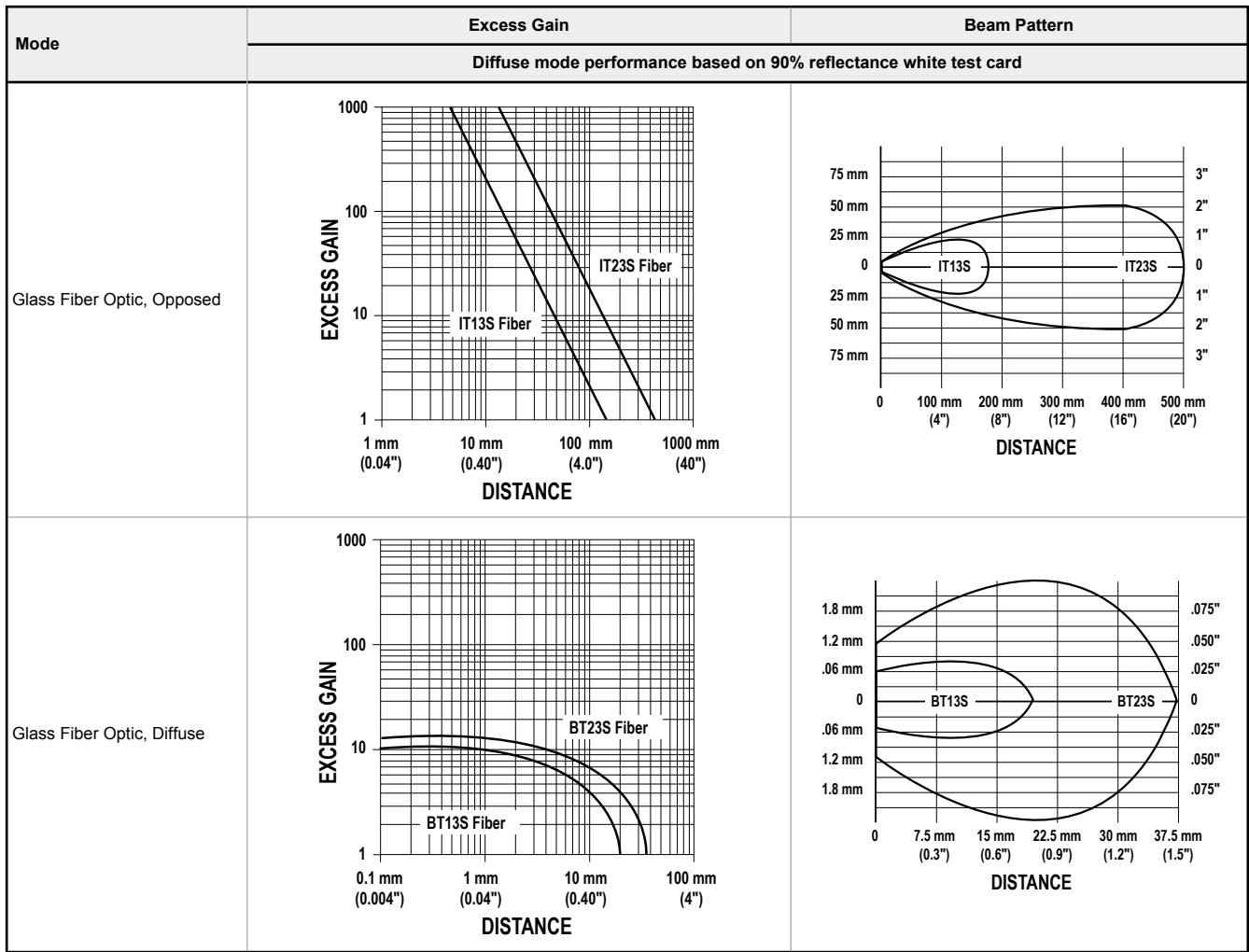

Dimensions

Figure 2. Opposed, Retro, Diffuse, Convergent Models

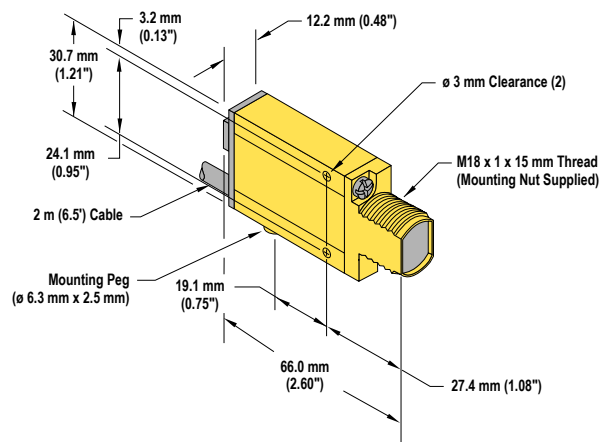

Figure 3. Diffuse Models

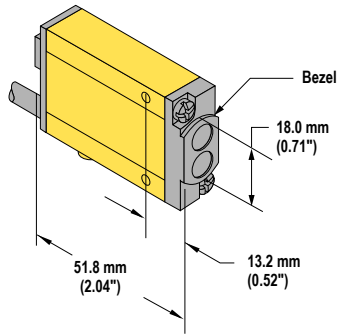
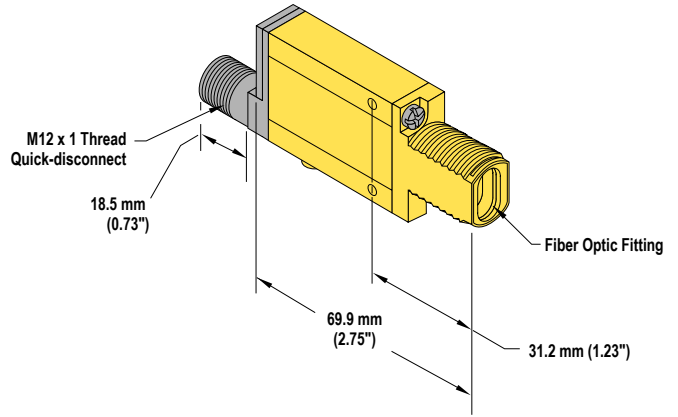

Figure 4. Glass Fiber Models



Accessories

Quick-Disconnect (QD) Cables

4-Pin Threaded M12 Cordsets (for use with NAMUR sensors)—Single Ended				
Model	Length	Style	Dimensions	Pinout (Female)
MQD9-406	2 m (6.56 ft)	Straight		
MQD9-415	5 m (16.4 ft)			
MQD9-430	9 m (29.5 ft)			
MQD9-406RA	2 m (6.56 ft)	Right-Angle		
MQD9-415RA	5 m (16.4 ft)			
MQD9-430RA	9 m (29.5 ft)			

1 = Brown  
2 = Blue

Brackets

SMB312S

- Stainless steel 2-axis, side-mount bracket

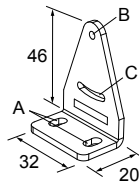

A = 4.3 × 7.5, B = diam. 3, C = 3 × 15.3

SMB46U

- Right-angle
- U bracket for sensor protection
- 14-ga. 316 stainless steel

Hole center spacing: A = 16.0  
Hole size: A = 16.5 × 18.7, B = 34.0 × 13.0

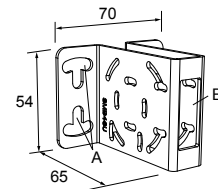



**SMB312B**

- Stainless steel 2-axis, bottom-mount bracket
- Includes mounting foot

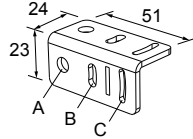

A = diam. 6.9, B = 4.3 × 10.5, C = 3.1 × 15.2

**SMB18A**

- Right-angle mounting bracket with a curved slot for versatile orientation
- 12-ga. stainless steel
- 18 mm sensor mounting hole
- Clearance for M4 (#8) hardware

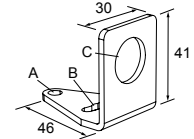

**Hole center spacing:** A to B = 24.2  
**Hole size:** A =  $\varnothing$  4.6, B = 17.0 × 4.6, C =  $\varnothing$  18.5

**SMB312PD**

- Right-angle mounting bracket with a curved slot for versatile orientation
- 12-ga. stainless steel
- 18 mm sensor mounting hole
- Clearance for M4 (#8) hardware

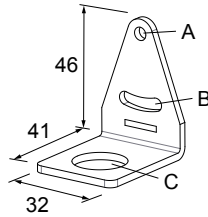

**Hole center spacing:** A to B = 24.2  
**Hole size:** A =  $\varnothing$  4.6, B = 17 × 4.6, C =  $\varnothing$  18.5



**Note:** Not for use with plastic fiber optic sensors

**SMB18FA..**

- Swivel bracket with tilt and pan movement for precision adjustment
- Easy sensor mounting to extruded rail T-slots
- Metric and inch size bolts available
- 18 mm sensor mounting hole

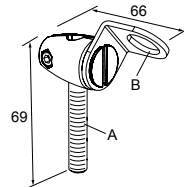

**Hole size:** B =  $\varnothing$  18.1

Model	Bolt Thread (A)
SMB18FA	3/8 - 16 × 2 in
SMB18FAM10	M10 - 1.5 × 50
SMB18FAM12	n/a; no bolt included. Mounts directly to 12 mm (1/2 in) rods

**SMB46L**

- Right-angle
- L bracket
- 14-ga. 316 stainless steel

**Hole center spacing:** A = 16.0  
**Hole size:** A = 16.5 × 18.7

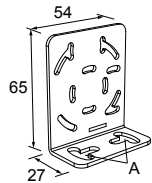

**SMB18Q**

- Right-angle flanged bracket
- 18 mm sensor mounting hole
- 12-ga. stainless steel

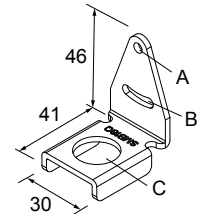

**Hole center spacing:** A to B = 24.2  
**Hole size:** A =  $\varnothing$  4.6, B = 17.0 × 4.6, C =  $\varnothing$  19.0

**SMB46S**

- Right-angle
- S bracket
- 14-ga. 316 stainless steel

**Hole center spacing:** A = 16.0  
**Hole size:** A = 16.5 × 18.7, B = 34.0 × 10.0

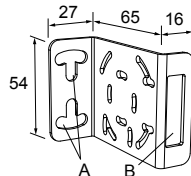

**SMB18SF**

- 18 mm swivel bracket with M18 × 1 internal thread
- Black thermoplastic polyester
- Stainless steel swivel locking hardware included

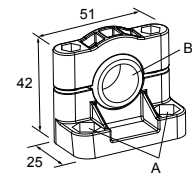

**Hole center spacing:** A = 36.0  
**Hole size:** A =  $\varnothing$  5.3, B =  $\varnothing$  18.0

**SMB3018SC**

- 18 mm swivel side or barrel-mount bracket
- Black reinforced thermoplastic polyester
- Stainless steel swivel locking hardware included

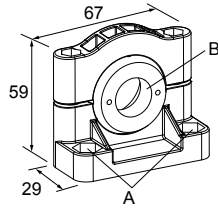

**Hole center spacing:** A = 50.8  
**Hole size:** A =  $\varnothing$  7.0, B =  $\varnothing$  18.0

**SMB18UR**

- 2-piece universal swivel bracket
- 300 series stainless steel
- Stainless steel swivel locking hardware included
- Mounting hole for 18 mm sensor

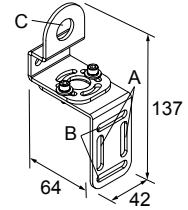

**Hole center spacing:** A = 25.4, B = 46.7  
**Hole size:** B = 6.9 × 32.0, C =  $\varnothing$  18.3

**SMB30SUS**

- Side-mount swivel with extended range of motion
- Black reinforced thermoplastic polyester
- Stainless steel swivel locking hardware included

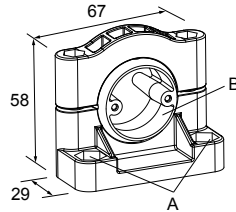

**Hole center spacing:** A = 50.8, B = 24.1  
**Hole size:** A =  $\varnothing$  7, B =  $\varnothing$  7.6

**SMBAMS18P**

- Flat SMBAMS series bracket with 18 mm hole
- Articulation slots for 90+° rotation
- 12-ga. (2.6 mm) cold-rolled steel

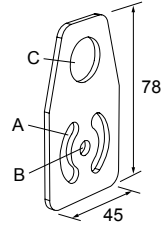

**Hole center spacing:** A = 26.0, A to B = 13.0  
**Hole size:** A = 26.8 × 7.0, B =  $\varnothing$  6.5, C =  $\varnothing$  19.0

**SMB30SK**

- Flat-mount swivel bracket with extended range of motion
- Black reinforced thermoplastic polyester and 316 stainless steel
- Stainless steel swivel locking hardware included

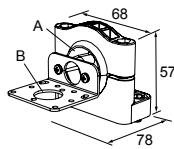

**Hole center spacing:** A = 50.8  
**Hole size:** A =  $\varnothing$  7, B =  $\varnothing$  18

**SMBAMS18RA**

- Right-angle SMBAMS series bracket with 18 mm hole
- Articulation slots for 90+° rotation
- 12-ga. (2.6 mm) cold-rolled steel

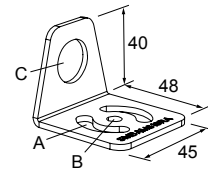

**Hole center spacing:** A = 26.0, A to B = 13.0  
**Hole size:** A = 26.8 × 7.0, B =  $\varnothing$  6.5, C =  $\varnothing$  19.0

## Repairs and Translations

Obtain assistance with product repairs by contacting your local Banner Engineering Corp distributor or by calling Banner directly at (763) 544-3164. Access literature translated into your native language on the Banner website at [www.bannerengineering.com](http://www.bannerengineering.com) or contact Banner directly at (763) 544-3164.

Para reparaciones de productos, por favor contacte a su distribuidor local de Banner Engineering o llame a Banner directamente al (763) 544-3164. Vea la literatura traducida en su idioma en el sitio web Banner en [www.bannerengineering.com](http://www.bannerengineering.com) o comuníquese con Banner directamente al (763) 544-3164.

Pour vous aider lors de la réparation de produits, contactez votre distributeur Banner local ou appelez directement Banner au (763) 544-3164. La documentation traduite dans votre langue est disponible sur le site internet de Banner [www.bannerengineering.com](http://www.bannerengineering.com) ou contactez directement Banner au (763) 544-3164.

## Banner Engineering Corp. Limited Warranty

---

Banner Engineering Corp. warrants its products to be free from defects in material and workmanship for one year following the date of shipment. Banner Engineering Corp. will repair or replace, free of charge, any product of its manufacture which, at the time it is returned to the factory, is found to have been defective during the warranty period. This warranty does not cover damage or liability for misuse, abuse, or the improper application or installation of the Banner product.

**THIS LIMITED WARRANTY IS EXCLUSIVE AND IN LIEU OF ALL OTHER WARRANTIES WHETHER EXPRESS OR IMPLIED (INCLUDING, WITHOUT LIMITATION, ANY WARRANTY OF MERCHANTABILITY OR FITNESS FOR A PARTICULAR PURPOSE), AND WHETHER ARISING UNDER COURSE OF PERFORMANCE, COURSE OF DEALING OR TRADE USAGE.**

This Warranty is exclusive and limited to repair or, at the discretion of Banner Engineering Corp., replacement. **IN NO EVENT SHALL BANNER ENGINEERING CORP. BE LIABLE TO BUYER OR ANY OTHER PERSON OR ENTITY FOR ANY EXTRA COSTS, EXPENSES, LOSSES, LOSS OF PROFITS, OR ANY INCIDENTAL, CONSEQUENTIAL OR SPECIAL DAMAGES RESULTING FROM ANY PRODUCT DEFECT OR FROM THE USE OR INABILITY TO USE THE PRODUCT, WHETHER ARISING IN CONTRACT OR WARRANTY, STATUTE, TORT, STRICT LIABILITY, NEGLIGENCE, OR OTHERWISE.**

Banner Engineering Corp. reserves the right to change, modify or improve the design of the product without assuming any obligations or liabilities relating to any product previously manufactured by Banner Engineering Corp. Any misuse, abuse, or improper application or installation of this product or use of the product for personal protection applications when the product is identified as not intended for such purposes will void the product warranty. Any modifications to this product without prior express approval by Banner Engineering Corp will void the product warranties. All specifications published in this document are subject to change; Banner reserves the right to modify product specifications or update documentation at any time. Specifications and product information in English supersede that which is provided in any other language. For the most recent version of any documentation, refer to: [www.bannerengineering.com](http://www.bannerengineering.com).

For patent information, see [www.bannerengineering.com/patents](http://www.bannerengineering.com/patents).