

TPS22924EVM-532

This user's guide describes the characteristics, operation, and use of the TPS22924EVM-532 evaluation module (EVM). This EVM demonstrates the Texas Instruments TPS22924 load switch with controlled turn on. The input voltage range of the TPS22924 is 0.75 V to 3.6 V. An integrated charge pump biases the NMOS switch to achieve a minimum switch ON resistance. The switch is controlled by an on/off input (EN), which is capable of interfacing directly with low-voltage control signals. This user's guide includes setup instructions, schematic diagram, bill of materials, and printed-circuit board layout drawings for the EVM.

1 Introduction

The TPS22924EVM-532 evaluation module (EVM) helps designers evaluate the operation and performance of the TPS22924 load switch. The board features the small 6-pin CSP package for a small solution size.

Table 1. TPS22924 VOUT Rise Time Options

EVM	Device	Rise Time (μs) Typical	VIN (V)	Max. Continuous Current	Enable (ON Pin)	Quick Output Discharge
HPA532-001	TPS22924B	100	3.6	2-A	Active High	Yes
HPA532-002	TPS22924C	840	3.6	2-A	Active High	Yes
HPA532-003	TPS22924D	6200	3.6	2-A	Active High	Yes

1.1 Related Documentation From Texas Instruments

TPS22924, ULTRA-SMALL, LOW-INPUT-VOLTAGE, LOW r_{ON} LOAD SWITCH data sheets ([SLVSA52](#), [SLVSAR3](#), [SLVSBT4](#))

2 Setup

This section describes the jumpers and connectors on the EVM as well as how to properly connect, set up, and use the TPS22924EVM-532.

2.1 J1/J3 – Input Connections

This is the connection for the leads from the input source. Connect the positive connection to the VIN J1 and the negative connection to the GND J3.

2.2 J4/J6 – Output Connections

This is the connection for the output of the TPS22924EVM. Connect the positive connection of the load to the VOUT J4 and the negative connection to the GND J6.

2.3 JP3 – EN

This is the enable input for the device. Place a shorting jumper across the HI and EN pins of JP3 to enable the integrated circuit (IC). Place a shorting jumper across the LO and EN pins of JP3 to disable the IC. A shorting jumper must be installed on JP3 in either the ON or OFF positions, and EN must not be left unconnected. An external enable source can be applied to the TPS22924 by removing the shunt and connecting a signal to the center pin of JP3. $EN \geq 0.75V$ is required for the ACTIVE or ON state of the device. A switching signal may also be used and connected at this point.

2.4 J2/J5 – V_{IN} Sense and V_{OUT} Sense

These two connectors are used when very accurate measurements of input or output voltage are required, Ron measurements should be made using these sense connections and measuring the voltage drop from VIN to VOUT and then calculating the resistance.

3 Operation

Connect the positive input of the power supply to the VIN J1 and the negative lead of the power supply to GND J3. The input voltage range of the TPS22924 is 0.75 V to 3.6 V.

Output load can be applied by connecting between J4 VOUT and J6 GND. The TPS22924 is rated for a maximum continuous current of 2A. Additional output load can be selected using JP6, JP7, and JP8. Shorting across JP6 selects R1 an 36 ohm on board resistor. JP7 selects R2 an 11 ohm on board resistor. JP8 selects R3 which is open for customer selection. R1, 2 and 3 are intended for light loads of the output, observe the 1/8W power rating for these parts. Configure jumper JP3 as required. JP3 must be installed for proper operation. ON is normal operation. While operating in the ON state the rise time of the device is internally controlled to avoid inrush current. Different rise times are selected by device types as shown above in [Table 1](#). In the OFF position, the device is shut down and a 1250- Ω on-chip load resistor is added for output quick discharge.

4 Test Results

See the *Typical Characteristics* section of the TPS22924 data sheet.

5 Test Configurations

5.1 On State Resistance (r_{ON}) Test Setup

Figure 1 shows a typical setup for measuring On State Resistance. The voltage drop across the switch is measured using the sense connections then divided by the current into the load yielding the r_{ON} resistance

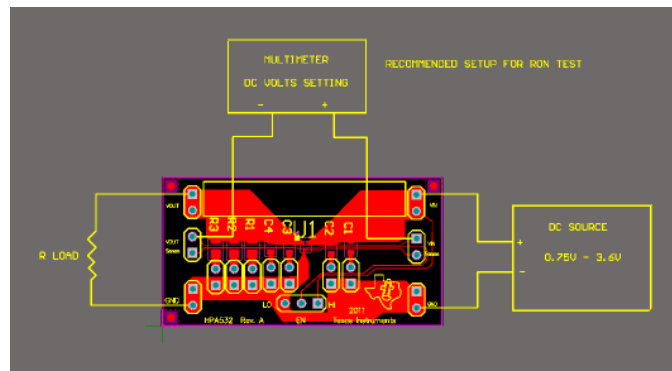

Figure 1. r_{ON} Setup

5.2 Slew Rate Test Setup

Figure 2 shows a test setup for measuring the Slew Rate of the Load Switch. Controlling the ON pin of the switch with a signal source and then measuring the output with a scope shows the switches ability to avoid inrush current.

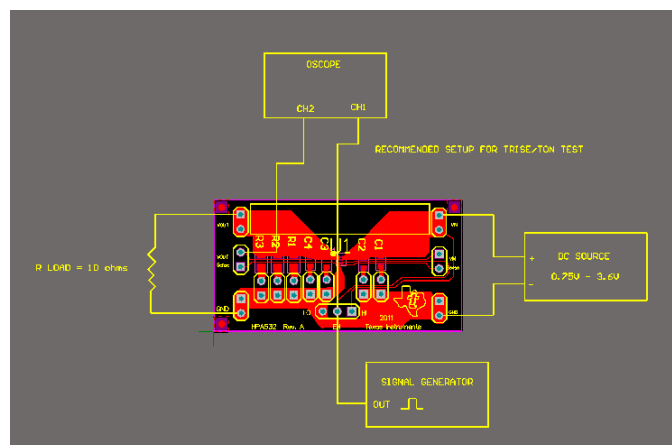

Figure 2. Slew Rate Setup

6 Board Layout, Schematic, and Bill of Materials

This section provides the TPS22924EVM-532 board layout, schematic, and bill of materials.

6.1 Board Layout

For best performance, all traces should be as short as possible. To be most effective, the input and output capacitors should be placed close to the device to minimize the effects that parasitic trace inductances may have on normal and short-circuit operation. Using wide traces for V_{IN} , V_{OUT} , and GND helps minimize the parasitic electrical effects along with minimizing the case to ambient thermal impedance. Figure 3 and Figure 4 show the board layout for the TPS22924EVM-532 PCB.

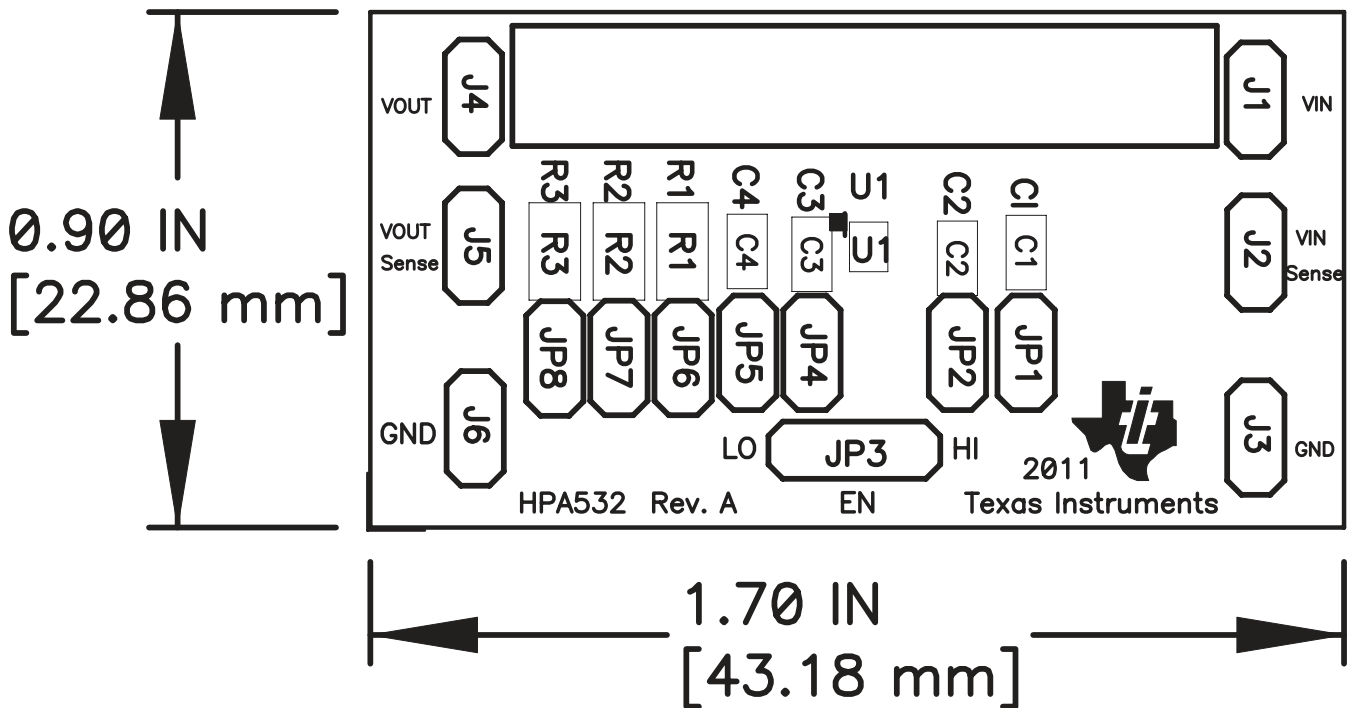

Figure 3. Top Assembly Layer

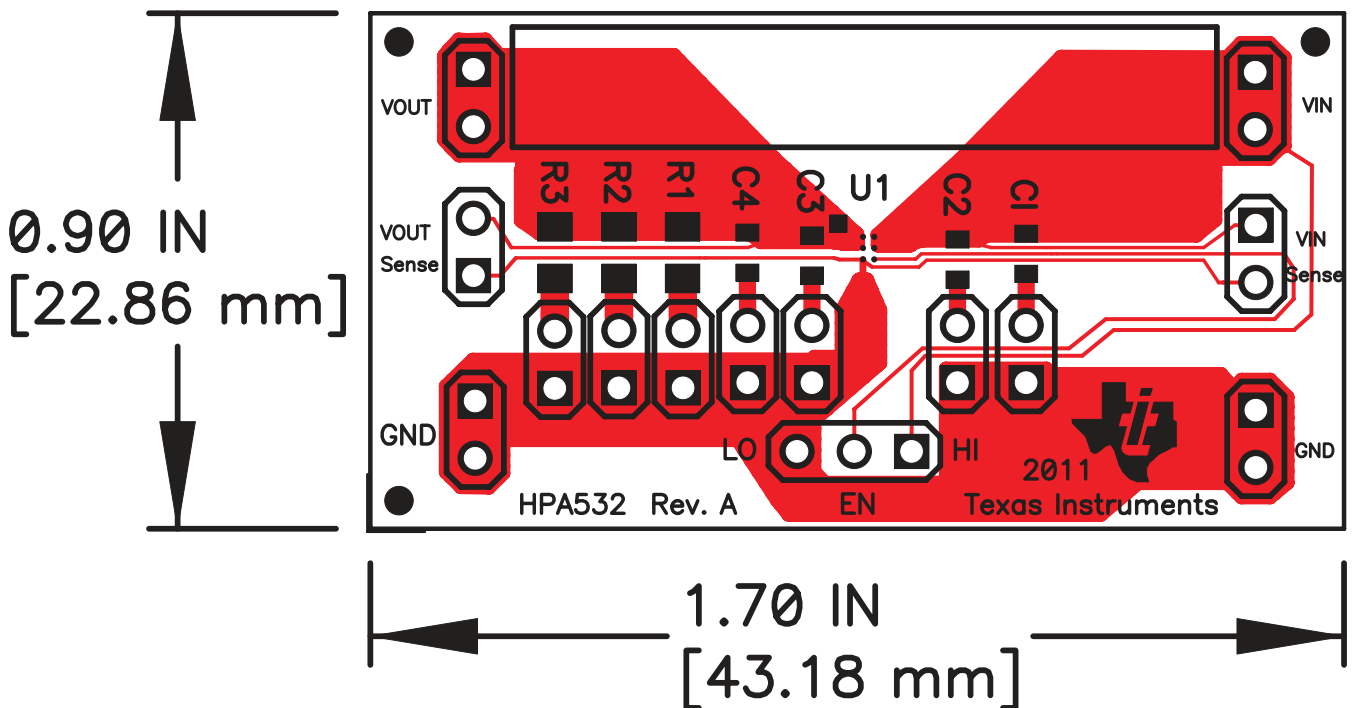

Figure 4. Top Layer

6.2 Schematic and Bill of Materials

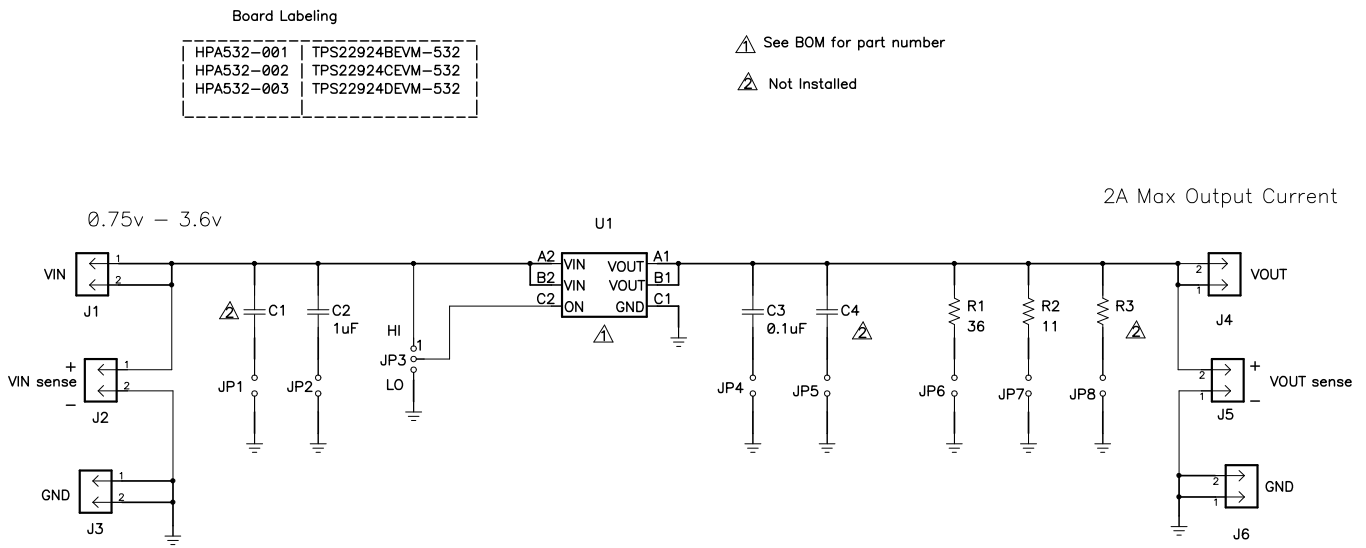

Figure 5. TPS22924EVM-532 Schematic

Table 2. Bill of Materials⁽¹⁾⁽²⁾⁽³⁾⁽⁴⁾

-001 COUNT	-002 COUNT	-003 COUNT	RefDes	Value	Description	SIZE	Part Number	MFR
1	1	1	--		PCB, 0.9 In x 1.7 In x 0.062 In		HPA532	Any
1	1	1	C3	0.1uF	Capacitor, Ceramic, 50-V, Y5V	603	GRM188F51H104ZA01D	MuRata
1	1	1	C2	1uF	Capacitor, Ceramic, 25-V, Y5V	603	GRM188F51E105A12D	MuRata
0	0	0	C1, C4	OPEN	Capacitor, Ceramic	603	Std	Std
1	1	1	R1	36	Resistor, 5% 1/8W	805	ERJ-6GEYJ360V	Panasonic
1	1	1	R2	11	Resistor, 5% 1/8W	805	ERJ-6GEYJ110V	Panasonic
0	0	0	R3	OPEN	Resistor, 5% 1/8W	805	Std	Std
13	13	13	J1-J6,JP1-2,JP4-8	PEC02SA AN	Header,2pin, 100mil spacing	0.100 inch x 2	PEC02SA AN	Sullins
1	1	1	JP3	PEC03SA AN	Header,3pin, 100mil spacing	0.100 inch x 3	PEC03SA AN	Sullins
1	0	0	U1	TPS22924 BYZ	IC, Single Chip, Low Input Voltage Current-Limited Load Switch with Shut Off Auto-Restart	YZ	TPS22924 BYZ	TI
0	1	0	U1	TPS22924 CYZP	IC, Single Chip, Low Input Voltage Current-Limited Load Switch with Shut Off Auto-Restart	YZP	TPS22924 CYZP	TI
0	0	1	U1	TPS22924 DYZP	IC, Single Chip, Low Input Voltage Current-Limited Load Switch with Shut Off Auto-Restart	YZP	TPS22924 DYZP	TI
1	1	1			Label (See note 5)	1.25 x 0.25 inch	THT-13-457-10	Brady
3	3	3	NA	NA	Shunt, 100-mil, Black	0.100	929950-00	3M

- (1) These assemblies are ESD sensitive, ESD precautions shall be observed.
- (2) These assemblies must be clean and free from flux and all contaminants. Use of no clean flux is not acceptable.
- (3) These assemblies must comply with workmanship standards IPC-A-610 Class 2.
- (4) Ref designators marked with an asterisk (**) cannot be substituted. All other components can be substituted with equivalent components.

Table 3.

Table 3	
Assembly number	Text
HPA532-001	TPS22924BEVM-532

Table 3. (continued)

Table 3	
Assembly number	Text
HPA532-002	TPS22924CEVM-532
HPA532-003	TPS22924DEVM-532

5.3 VOUT Rise Time and TON Response

Tek Run: 10.0MS/s Sample

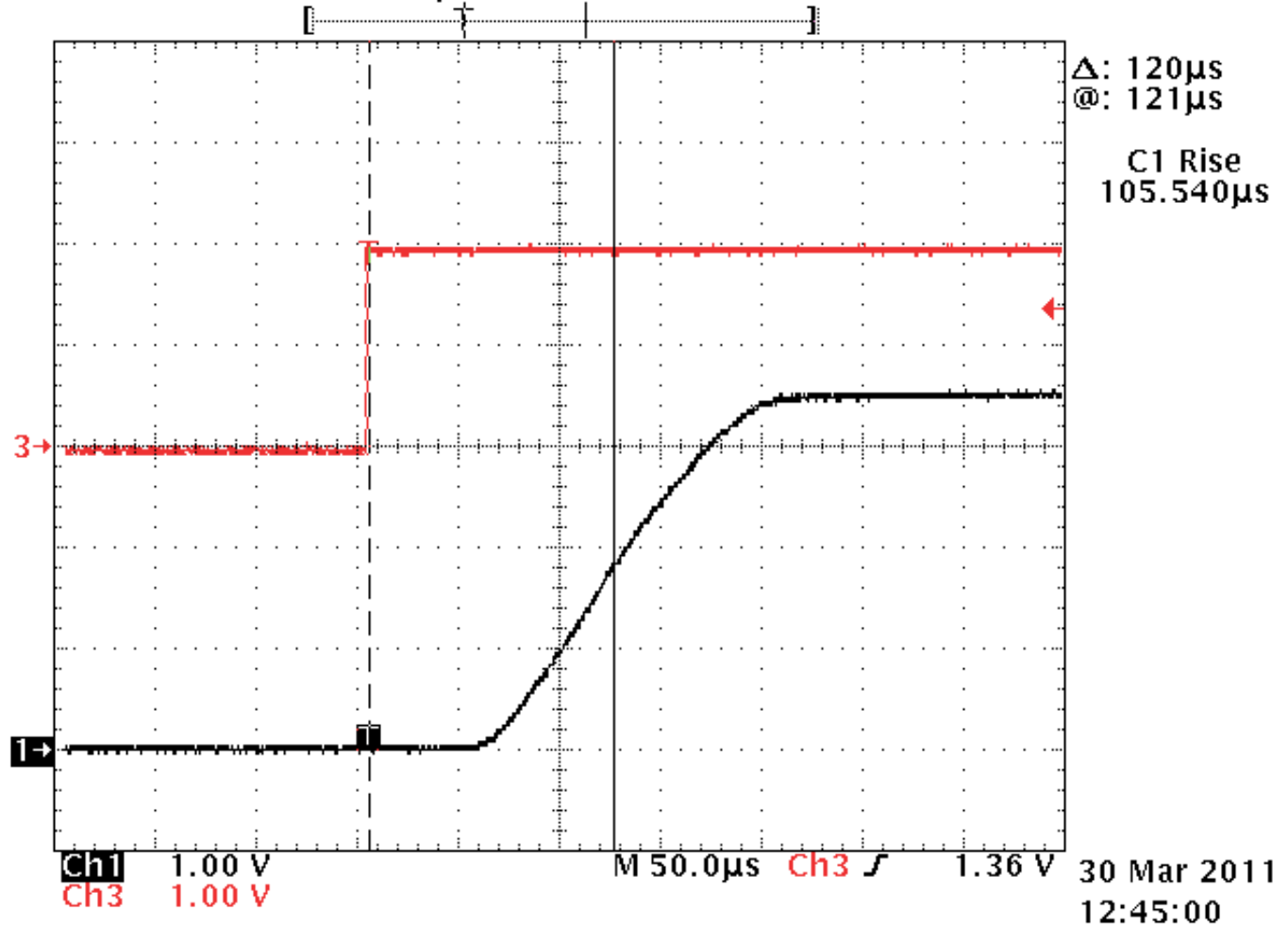

Figure 6. TPS22924B TON and Trise Example

Tek Run: 250kS/s

Sample

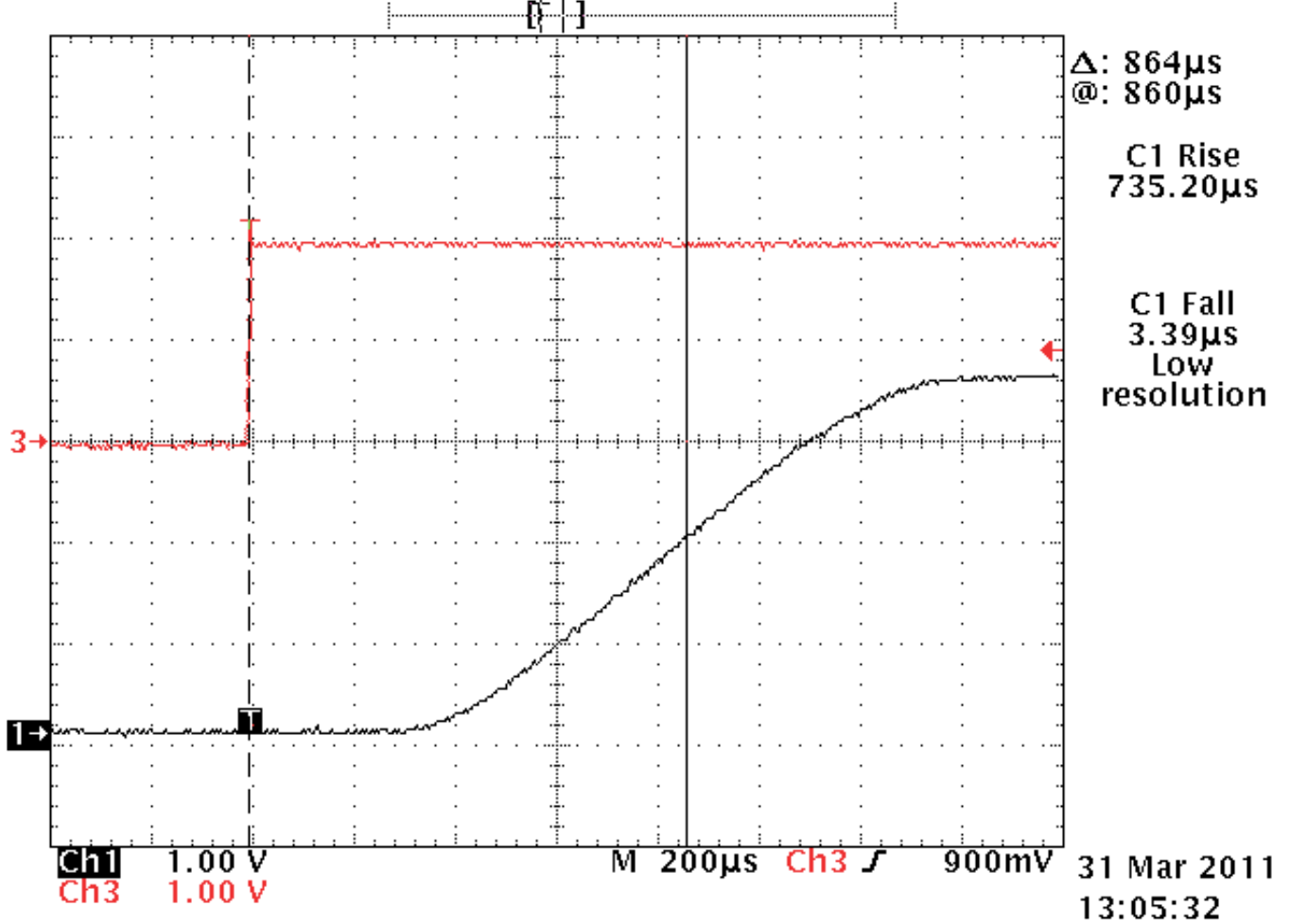

Figure 7. TPS22924C TON and Trise Example

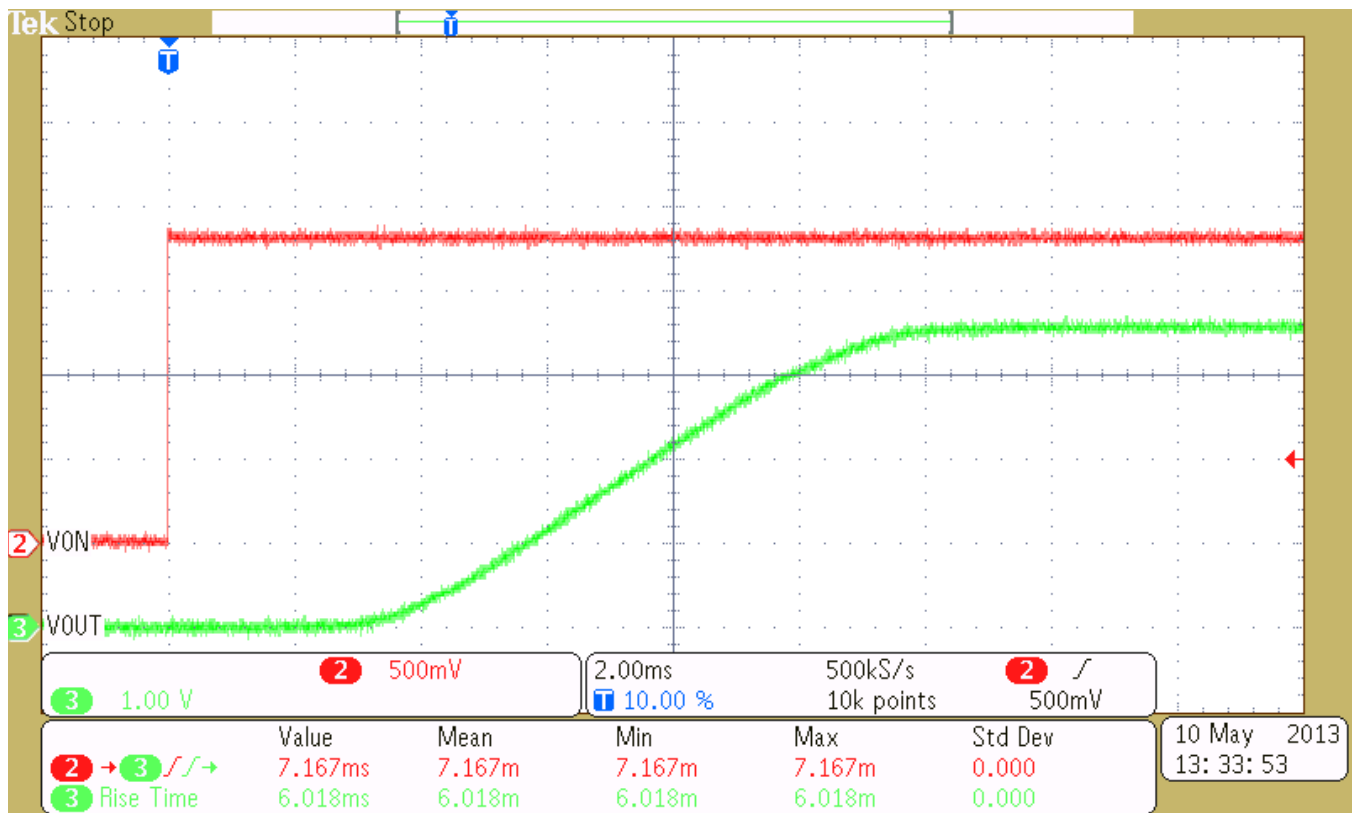

Figure 8. TPS22924D TON and Trise Example

Evaluation Board/Kit Important Notice

Texas Instruments (TI) provides the enclosed product(s) under the following conditions:

This evaluation board/kit is intended for use for **ENGINEERING DEVELOPMENT, DEMONSTRATION, OR EVALUATION PURPOSES ONLY** and is not considered by TI to be a finished end-product fit for general consumer use. Persons handling the product(s) must have electronics training and observe good engineering practice standards. As such, the goods being provided are not intended to be complete in terms of required design-, marketing-, and/or manufacturing-related protective considerations, including product safety and environmental measures typically found in end products that incorporate such semiconductor components or circuit boards. This evaluation board/kit does not fall within the scope of the European Union directives regarding electromagnetic compatibility, restricted substances (RoHS), recycling (WEEE), FCC, CE or UL, and therefore may not meet the technical requirements of these directives or other related directives.

Should this evaluation board/kit not meet the specifications indicated in the User's Guide, the board/kit may be returned within 30 days from the date of delivery for a full refund. **THE FOREGOING WARRANTY IS THE EXCLUSIVE WARRANTY MADE BY SELLER TO BUYER AND IS IN LIEU OF ALL OTHER WARRANTIES, EXPRESSED, IMPLIED, OR STATUTORY, INCLUDING ANY WARRANTY OF MERCHANTABILITY OR FITNESS FOR ANY PARTICULAR PURPOSE.**

The user assumes all responsibility and liability for proper and safe handling of the goods. Further, the user indemnifies TI from all claims arising from the handling or use of the goods. Due to the open construction of the product, it is the user's responsibility to take any and all appropriate precautions with regard to electrostatic discharge.

EXCEPT TO THE EXTENT OF THE INDEMNITY SET FORTH ABOVE, NEITHER PARTY SHALL BE LIABLE TO THE OTHER FOR ANY INDIRECT, SPECIAL, INCIDENTAL, OR CONSEQUENTIAL DAMAGES.

TI currently deals with a variety of customers for products, and therefore our arrangement with the user **is not exclusive.**

TI assumes **no liability for applications assistance, customer product design, software performance, or infringement of patents or services described herein.**

Please read the User's Guide and, specifically, the Warnings and Restrictions notice in the User's Guide prior to handling the product. This notice contains important safety information about temperatures and voltages. For additional information on TI's environmental and/or safety programs, please contact the TI application engineer or visit www.ti.com/esh.

No license is granted under any patent right or other intellectual property right of TI covering or relating to any machine, process, or combination in which such TI products or services might be or are used.

FCC Warning

This evaluation board/kit is intended for use for **ENGINEERING DEVELOPMENT, DEMONSTRATION, OR EVALUATION PURPOSES ONLY** and is not considered by TI to be a finished end-product fit for general consumer use. It generates, uses, and can radiate radio frequency energy and has not been tested for compliance with the limits of computing devices pursuant to part 15 of FCC rules, which are designed to provide reasonable protection against radio frequency interference. Operation of this equipment in other environments may cause interference with radio communications, in which case the user at his own expense will be required to take whatever measures may be required to correct this interference.

EVM Warnings and Restrictions

It is important to operate this EVM within the input voltage range of 0.75 V to 3.6 V and the output voltage range of .

Exceeding the specified input range may cause unexpected operation and/or irreversible damage to the EVM. If there are questions concerning the input range, please contact a TI field representative prior to connecting the input power.

Applying loads outside of the specified output range may result in unintended operation and/or possible permanent damage to the EVM. Please consult the EVM User's Guide prior to connecting any load to the EVM output. If there is uncertainty as to the load specification, please contact a TI field representative.

During normal operation, some circuit components may have case temperatures greater than 50°C. The EVM is designed to operate properly with certain components above 60°C as long as the input and output ranges are maintained. These components include but are not limited to linear regulators, switching transistors, pass transistors, and current sense resistors. These types of devices can be identified using the EVM schematic located in the EVM User's Guide. When placing measurement probes near these devices during operation, please be aware that these devices may be very warm to the touch.

Mailing Address: Texas Instruments, Post Office Box 655303, Dallas, Texas 75265
Copyright © 2013, Texas Instruments Incorporated

IMPORTANT NOTICE

Texas Instruments Incorporated and its subsidiaries (TI) reserve the right to make corrections, enhancements, improvements and other changes to its semiconductor products and services per JESD46, latest issue, and to discontinue any product or service per JESD48, latest issue. Buyers should obtain the latest relevant information before placing orders and should verify that such information is current and complete. All semiconductor products (also referred to herein as "components") are sold subject to TI's terms and conditions of sale supplied at the time of order acknowledgment.

TI warrants performance of its components to the specifications applicable at the time of sale, in accordance with the warranty in TI's terms and conditions of sale of semiconductor products. Testing and other quality control techniques are used to the extent TI deems necessary to support this warranty. Except where mandated by applicable law, testing of all parameters of each component is not necessarily performed.

TI assumes no liability for applications assistance or the design of Buyers' products. Buyers are responsible for their products and applications using TI components. To minimize the risks associated with Buyers' products and applications, Buyers should provide adequate design and operating safeguards.

TI does not warrant or represent that any license, either express or implied, is granted under any patent right, copyright, mask work right, or other intellectual property right relating to any combination, machine, or process in which TI components or services are used. Information published by TI regarding third-party products or services does not constitute a license to use such products or services or a warranty or endorsement thereof. Use of such information may require a license from a third party under the patents or other intellectual property of the third party, or a license from TI under the patents or other intellectual property of TI.

Reproduction of significant portions of TI information in TI data books or data sheets is permissible only if reproduction is without alteration and is accompanied by all associated warranties, conditions, limitations, and notices. TI is not responsible or liable for such altered documentation. Information of third parties may be subject to additional restrictions.

Resale of TI components or services with statements different from or beyond the parameters stated by TI for that component or service voids all express and any implied warranties for the associated TI component or service and is an unfair and deceptive business practice. TI is not responsible or liable for any such statements.

Buyer acknowledges and agrees that it is solely responsible for compliance with all legal, regulatory and safety-related requirements concerning its products, and any use of TI components in its applications, notwithstanding any applications-related information or support that may be provided by TI. Buyer represents and agrees that it has all the necessary expertise to create and implement safeguards which anticipate dangerous consequences of failures, monitor failures and their consequences, lessen the likelihood of failures that might cause harm and take appropriate remedial actions. Buyer will fully indemnify TI and its representatives against any damages arising out of the use of any TI components in safety-critical applications.

In some cases, TI components may be promoted specifically to facilitate safety-related applications. With such components, TI's goal is to help enable customers to design and create their own end-product solutions that meet applicable functional safety standards and requirements. Nonetheless, such components are subject to these terms.

No TI components are authorized for use in FDA Class III (or similar life-critical medical equipment) unless authorized officers of the parties have executed a special agreement specifically governing such use.

Only those TI components which TI has specifically designated as military grade or "enhanced plastic" are designed and intended for use in military/aerospace applications or environments. Buyer acknowledges and agrees that any military or aerospace use of TI components which have **not** been so designated is solely at the Buyer's risk, and that Buyer is solely responsible for compliance with all legal and regulatory requirements in connection with such use.

TI has specifically designated certain components as meeting ISO/TS16949 requirements, mainly for automotive use. In any case of use of non-designated products, TI will not be responsible for any failure to meet ISO/TS16949.

Products

Audio	www.ti.com/audio
Amplifiers	amplifier.ti.com
Data Converters	dataconverter.ti.com
DLP® Products	www.dlp.com
DSP	dsp.ti.com
Clocks and Timers	www.ti.com/clocks
Interface	interface.ti.com
Logic	logic.ti.com
Power Mgmt	power.ti.com
Microcontrollers	microcontroller.ti.com
RFID	www.ti-rfid.com
OMAP Applications Processors	www.ti.com/omap
Wireless Connectivity	www.ti.com/wirelessconnectivity

Applications

Automotive and Transportation	www.ti.com/automotive
Communications and Telecom	www.ti.com/communications
Computers and Peripherals	www.ti.com/computers
Consumer Electronics	www.ti.com/consumer-apps
Energy and Lighting	www.ti.com/energy
Industrial	www.ti.com/industrial
Medical	www.ti.com/medical
Security	www.ti.com/security
Space, Avionics and Defense	www.ti.com/space-avionics-defense
Video and Imaging	www.ti.com/video

TI E2E Community

e2e.ti.com