

# Bookstyle EMC/EMI Filter for Motor Drives

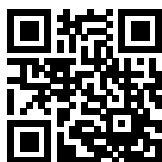

- Exceptional broadband attenuation performance from 10 kHz up to 30 MHz
- Slim and user-friendly book-style design with touch-safe terminal blocks for minimum space and maximum safety
- Enables compliance with Class B limits



### Performance indicators

Attenuation performance



Rated current [A]

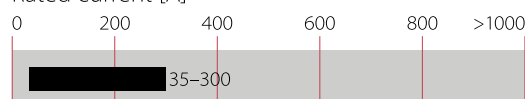

### Approvals & Compliances



(FN3100 up to 150 A)

### Features and Benefits

- High performance filter for mainly industrial motor drive applications with significant interference levels
- Attenuation performance for Class B compliance in applications comprising multiple motor drives (e.g. machine tool with up to 8 driving axes with ~10 to 20 m motor cable each)
- Broadband filter performance with low frequency attenuation down to 10 kHz for reliable suppression of conducted interference
- Slim book-style shape requiring minimum cabinet space and allowing convenient installation right beside the motor drive
- Touch-safe terminal blocks provide unsurpassed electrical safety and contacting cross section according to EN 60204-1 installation standard
- For even better filter specifications, please consider FN 3120 H series from Schaffner

## Technical Specifications

<b>Maximum continuous operating voltage</b>	3x 520/300 VAC
<b>Operating frequency</b>	DC to 60 Hz
<b>Rated currents</b>	35 to 300 A @ 50°C
<b>High potential test voltage</b>	P → E 2750 VDC for 2 sec P → P 2250 VDC for 2 sec
<b>Protection category</b>	IP 20
<b>Overload capability</b>	4x rated current at switch on, 1.5x rated current for 1 minute, once per hour
<b>Temperature range (operation and storage)</b>	-25°C to +100°C (25/100/21)
<b>Flammability corresponding to</b>	UL 94 V-2 or better
<b>Design corresponding to</b>	UL 1283, CSA 22.2 No. 8 1986, IEC/EN 60939
<b>MTBF @ 50°C/400 V (Mil-HB-217F)</b>	>400,000 hours



## Typical Applications

- Conventional motor drives with long motor cables and high interference levels
- Four quadrant motor drives and servo drives with energy regeneration mode (in combination with a suitable line reactor or LCL filter)
- Industrial applications comprising power conversion devices, such as machinery, machine tools and process automation equipment
- Uninterruptible power supplies (UPS)
- Converters for renewable energy generation
- Thyristor drives
- Elevators and cranes

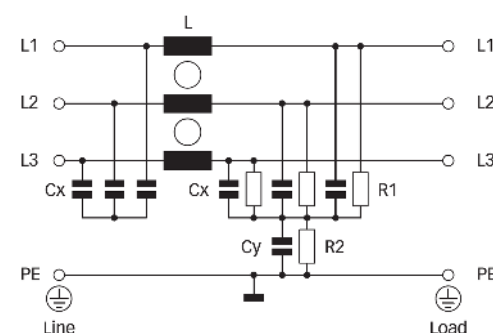
### Typical electrical schematic



### Filter Selection Table

Filter	Rated current @ 50°C (40°C)	Typical drive power rating*	Leakage current** @ 520 VAC/50 Hz	Power loss @ 25°C/50 Hz	Input/Output connections		Weight
	[A]	[kW]	[mA]	[W]			[kg]
<b>FN 3100-35-33</b>	35 (38.4)	22	6.8	11.8	-33		2.3
<b>FN 3100-50-34</b>	50 (54.8)	30	9.3	18.0	-34		3.4
<b>FN 3100-80-35</b>	80 (87.6)	45	10.0	25.9	-35		5.0
<b>FN 3100-110-35</b>	110 (120.5)	55	10.0	32.7	-35		5.4
<b>FN 3100-150-40</b>	150 (164.3)	75	10.0	50.6	-40		8.5
<b>FN 3100-200-40</b>	200 (219)	110	10.0	67.2	-40		9.1
<b>FN 3100-230-40</b>	230 (230)	132	10.0	36.5	-40		9.2
<b>FN 3100-300-99</b>	300 (329)	160	10.0	54.0		-99	11.8

\* Calculated at rated current, 480 VAC and cos phi=0.8. The exact value depends upon the efficiency of the drive, the motor and the entire application.

\*\* Standardized calculated leakage current acc. IEC60939 under normal operating conditions.

### Typical Filter Attenuation

Per CISPR 17; A=50 Ω/50 Ω sym; B=50 Ω/50 Ω asym; C=0.1 Ω/100 Ω sym; D=100 Ω/0.1 Ω sym

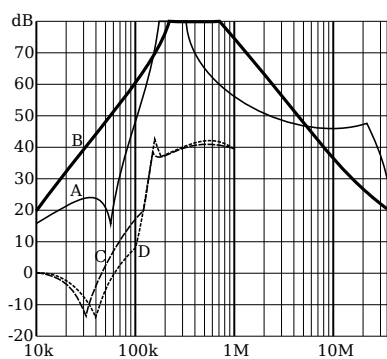

35 to 80 A types

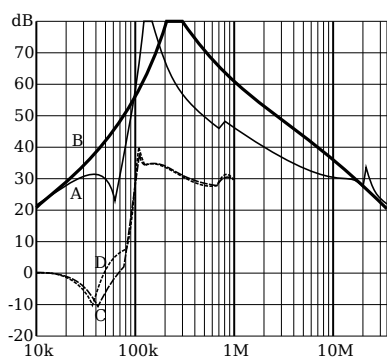

110 and 150 A types

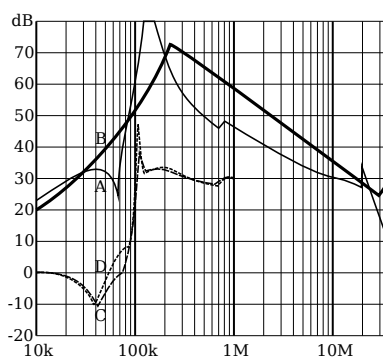

200 A types

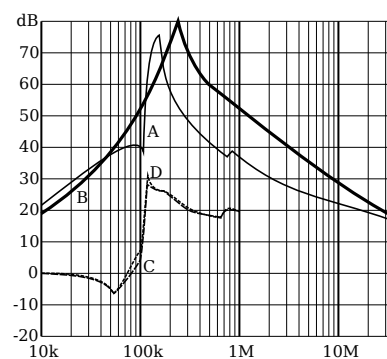

230 and 300 A types

### Mechanical Data

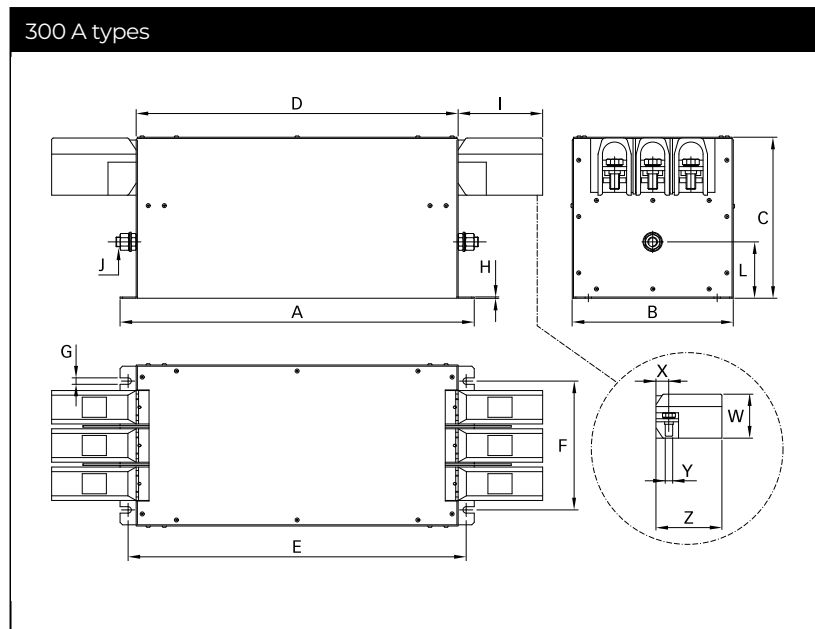
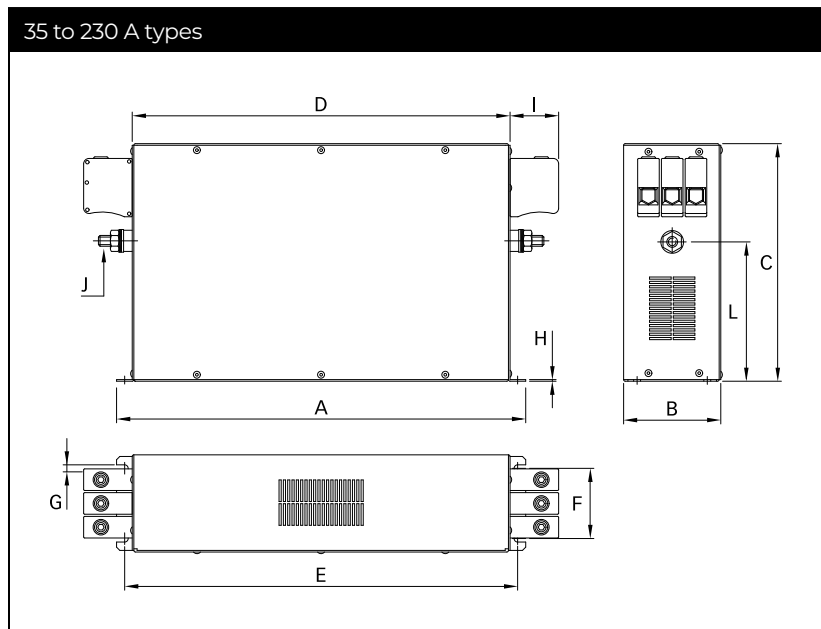

### Dimensions

	35 A	50 A	80 A	110 A	150 A	200 A	230 A	300 A
<b>A</b>	335	329	379	379	438	438	438	440
<b>B</b>	60	80	90	90	110	110	110	200
<b>C</b>	150	185	220	220	240	240	240	200
<b>D</b>	305	300	350	350	400	400	400	400
<b>E</b>	320	314	364	364	413	413	413	420
<b>F</b>	35	55	65	65	80	80	80	160
<b>G</b>	6.5	6.5	6.5	6.5	6.5	6.5	6.5	8
<b>H</b>	1	1.5	1.5	1.5	4	4	4	1.5
<b>I</b>	25	39	45	45	51	51	51	105
<b>J</b>	M5	M6	M10	M10	M10	M10	M10	M12
<b>L</b>	93.5	107	129	129	108	108	108	70
<b>W</b>								71.5
<b>X</b>								~22
<b>Y</b>								M12
<b>Y</b>								~105

All dimensions in mm; 1 inch = 25.4 mm  
Tolerances according: ISO 2768-m/EN 22768-m

### Filter Input/Output Connector Cross Sections

	-33	-34	-35	-40	-99
<b>Solid wire</b>	16 mm <sup>2</sup>	35 mm <sup>2</sup>	50 mm <sup>2</sup>	95 mm <sup>2</sup>	-
<b>Flex wire</b>	10 mm <sup>2</sup>	25 mm <sup>2</sup>	50 mm <sup>2</sup>	95 mm <sup>2</sup>	150 mm <sup>2</sup>
<b>AWG type wire</b>	AWG 6	AWG 2	AWG 1/0	AWG 4/0	AWG 6/0
<b>Recommended torque</b>	1.5 - 1.8 Nm	4.0 - 4.5 Nm	7 - 8 Nm	17 - 20 Nm	27 - 30 Nm

Please visit [www.schaffner.com](http://www.schaffner.com) to find more details on filter connectors.

## Headquarters, Global Innovation and Development

### Switzerland

#### Schaffner Holding AG

Industrie Nord  
 Nordstrasse 11e  
 4542  
 Luterbach  
 +41 32 681 66 26  
[info@schaffner.com](mailto:info@schaffner.com)

## Sales and Application Centers

### China

#### Schaffner EMC Ltd. Shanghai

T20-3 C, No 565 Chuangye Road, Pudong district  
 201201  
 Shanghai  
 +86 2138139500  
[cschina@schaffner.com](mailto:cschina@schaffner.com)

### Finland

#### Schaffner Oy

Sauvonrinne 19 H  
 8500  
 Lohja  
 +358 50 468 7284  
[finlandsales@schaffner.com](mailto:finlandsales@schaffner.com)

### France

#### Schaffner EMC S.A.S.

16-20 Rue Louis Rameau  
 95875  
 Bezons  
 +33 1 34 34 30 60  
[francesales@schaffner.com](mailto:francesales@schaffner.com)

### Germany

#### Schaffner Deutschland GmbH

Schoemperlenstrasse 12B  
 76185  
 Karlsruhe  
 +49 721 56910  
[germanysales@schaffner.com](mailto:germanysales@schaffner.com)

### India

#### Schaffner India Pvt. Ltd

Regus World Trade Centre  
 WTC, 22nd Floor Unit No 2238, Brigade Gateway Campus, 26/1, Dr. Rajkumar Road Malleshwaram (W)  
 560055  
 Bangalore  
 +91 8067935355  
[indiasales@schaffner.com](mailto:indiasales@schaffner.com)

### Italy

#### Schaffner EMC S.r.l.

Via Ticino, 30  
 20900  
 Monza (MB)  
 +39 039 21 41 070  
[italysales@schaffner.com](mailto:italysales@schaffner.com)

### Japan

#### Schaffner EMC K.K.

ISM Sangenjaya 7F  
 1-32-12 Kamiuma, Setagaya-ku  
 154-0011  
 Tokyo  
 +81 3 5712 3650  
[japansales@schaffner.com](mailto:japansales@schaffner.com)

### Singapore

#### Schaffner EMC Pte Ltd.

Blk 3015A Ubi Road 1, #05-09, Kampong Ubi Industrial Estate  
 408705  
 Singapore  
 +65 63773283  
[singaporesales@schaffner.com](mailto:singaporesales@schaffner.com)

### Spain

#### Schaffner EMC España

Calle Caléndula 93, Miniparc III, Edificio E El Soto de Moraleja, Alcobendas  
 28109  
 Madrid  
 +34 917 912 900  
[spainsales@schaffner.com](mailto:spainsales@schaffner.com)

### Sweden

#### Schaffner EMC AB

Östermalmstrorg 1  
 114 42  
 Stockholm  
 +46 8 5050 2425  
[swedensales@schaffner.com](mailto:swedensales@schaffner.com)

### Switzerland

#### Schaffner EMV AG

Industrie Nord  
 Nordstrasse 11e  
 4542  
 Luterbach  
 +41 32 681 66 26  
[switzerlandsales@schaffner.com](mailto:switzerlandsales@schaffner.com)

### Taiwan

#### Schaffner EMV Ltd.

U-Town  
 20 Floor-2, No 97, Section 1, XinTai 5th Road, XiZhi District  
 22175  
 New Taipei City  
 +886 226975500  
[taiwansales@schaffner.com](mailto:taiwansales@schaffner.com)

### Thailand

#### Schaffner EMC Co. Ltd.

Sathorn Square Tower  
 Room 3780, 37FL, 98 North-Sathorn Rd, Silom, Bangrak  
 10500  
 Bangkok  
 +66 621056397  
[thailandsales@schaffner.com](mailto:thailandsales@schaffner.com)

### United Kingdom

#### Schaffner Ltd.

1, Oakmede Place  
 Terrace Road  
 RG42 4JF  
 Binfield  
 +44 118 9770070  
[uksales@schaffner.com](mailto:uksales@schaffner.com)

### United States

#### Schaffner EMC Inc.

52 Mayfield Avenue  
 Edison, New Jersey  
 +1 732 225 9533  
[usasales@schaffner.com](mailto:usasales@schaffner.com)

To find your local partner within Schaffner's global network [schaffner.com](http://schaffner.com)

© 2022 Schaffner Group

The content of this document has been carefully checked and understood. However, neither Schaffner nor its subsidiaries assume any liability whatsoever for any errors or inaccuracies of this document and the consequences thereof. Published specifications are subject to change without notice. Product suitability for any area of application must ultimately be determined by the customer. In all cases, products must never be operated outside their published specifications. Schaffner does not guarantee the availability of all published products. This disclaimer shall be governed by substantive Swiss law and resulting disputes shall be settled by the courts at the place of business of Schaffner Holding AG. Latest publications and a complete disclaimer can be downloaded from the Schaffner website. All trademarks recognized.