

X-Band PIN Diode Limiter

6 - 12 GHz



MADL-011088-DIE

Rev. V1

Features

- Insertion Loss <0.5 dB
- Return Loss >18 dB
- Handles 39 dBm CW Power
- Low Flat Leakage Power <15 dBm
- Die Size: 1.78 x 0.98 mm
- RoHS* Compliant
- External DC Bias May Be Applied

Applications

- ISM/MM
- Radar
- EW

Description

The MADL-011088-DIE is an integrated AlGaAs PIN Diode limiter. It is DC de-coupled at both the input and output ports and can be used with or without DC bias applied.

The limiter DC bias can be grounded to achieve low insertion loss, typically 0.35 dB up to 12 GHz. When applying a DC bias up to 0.7 V, ultra low flat leakage of less than 14 dBm across the power range can be achieved.

The MADL-011088-DIE can limit up to 39 dBm incident CW power at room temperature. It is available in die form with a compact die dimension of 1.78 x 0.98 mm.

Functional Schematic

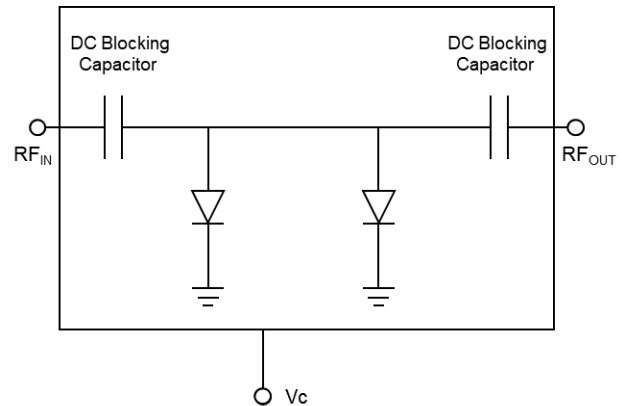

Pin Configuration

Pin #	Pin Name	Description
1, 3, 4, 6	GND	Ground
2	RF _{IN}	RF Input
5	RF _{OUT}	RF Output
7	V _C	Limiter DC Bias

Ordering Information

Part Number	Package
MADL-011088-DIE	Die in Gel Pack

* Restrictions on Hazardous Substances, compliant to current RoHS EU directive.

X-Band PIN Diode Limiter

6 - 12 GHz



MADL-011088-DIE

Rev. V1

Electrical Specifications: Freq. 6 - 12 GHz, $T_A = 25^\circ\text{C}$, $Z_0 = 50 \Omega$

Parameter	Test Conditions	Units	Min.	Typ.	Max.
Insertion Loss	$P_{IN} = -10 \text{ dBm}$, $V_C = 0 \text{ V}$ $P_{IN} = -10 \text{ dBm}$, $V_C = 0.7 \text{ V}$	dB	—	0.35 0.45	0.6 0.7
Input Return Loss	$P_{IN} = -10 \text{ dBm}$, $V_C = 0 \text{ V}$	dB	16	21	—
Output Return Loss	$P_{IN} = -10 \text{ dBm}$, $V_C = 0 \text{ V}$	dB	16	21	—
CW Incident Power	—	dBm	—	39	—
CW Flat Leakage	$P_{IN} > 32 \text{ dBm}$, $V_C = 0 \text{ V}$ $P_{IN} > 25 \text{ dBm}$, $V_C = 0.7 \text{ V}$	dBm	—	17.5 12.0	19 14
Spike Leakage Power	$P_{IN} = 40 \text{ dBm}$, 100 μs , 1% DC, $V_C = 0 \text{ V}$, 12 GHz $P_{IN} = 40 \text{ dBm}$, 100 μs , 1% DC, $V_C = 0.7 \text{ V}$, 12 GHz	dBm	—	21.4 19.0	—
Recovery Time (1 dB Insertion Loss)	$P_{IN} = 40 \text{ dBm}$, 100 μs , 1% DC, $V_C = 0 \text{ V}$, 12 GHz $P_{IN} = 40 \text{ dBm}$, 100 μs , 1% DC, $V_C = 0.7 \text{ V}$, 12 GHz	ns	—	50 95	—
Input IP3	10 MHz Offset, $P_{IN}/\text{tone} = 0 \text{ dBm}$, $V_C = 0 \text{ V}$, 12 GHz 10 MHz Offset, $P_{IN}/\text{tone} = 0 \text{ dBm}$, $V_C = 0.7 \text{ V}$, 12 GHz	dBm	—	38 25	—

Absolute Maximum Ratings^{1,2}

Parameter	Absolute Maximum
Incident CW RF Power @ +85°C	35
Bias Voltage	1 V
Junction Temperature ³	+150°C
Operating Temperature	-40°C to +85°C
Storage Temperature	-55°C to +150°C

- Exceeding any one or combination of these limits may cause permanent damage to this device.
- MACOM does not recommend sustained operation near these survivability limits.
- Operating at nominal conditions with $T_J \leq +150^\circ\text{C}$ will ensure $\text{MTTF} > 1 \times 10^6$ hours.

Handling Procedures

The protective polymer coating on the active areas of the die provides scratch and impact protection, particularly for the metal air bridge, which contacts the diode's anode. Die should primarily be handled with vacuum pickup tools, or alternatively with plastic tweezers.

Static Sensitivity

These electronic devices are sensitive to electrostatic discharge (ESD) and can be damaged by static electricity. Proper ESD control techniques should be used when handling HBM Class 1B devices.

X-Band PIN Diode Limiter

6 - 12 GHz



MADL-011088-DIE
Rev. V1

Typical Small-Signal Performance, On-Wafer: $T_A = 25^\circ\text{C}$, $Z_0 = 50 \Omega$

Insertion Loss over V_C Bias

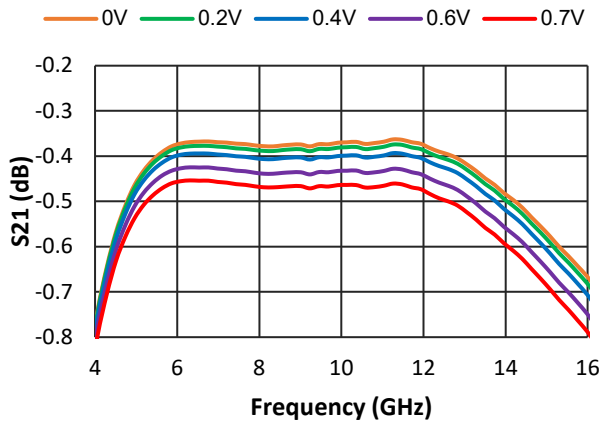

Input Return Loss over V_C Bias

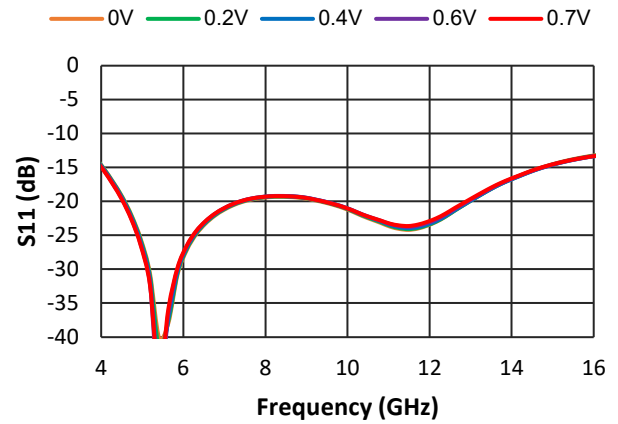

Output Return Loss over V_C Bias

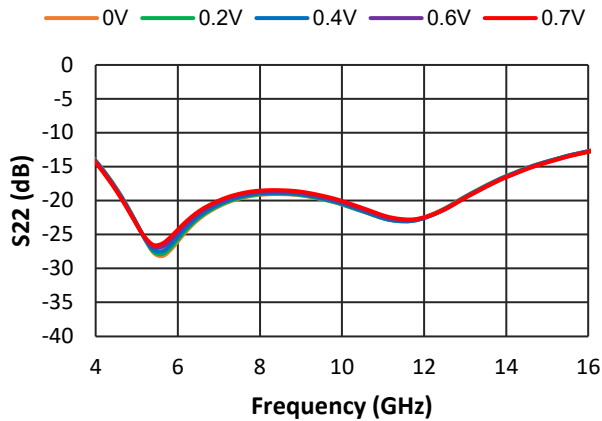

X-Band PIN Diode Limiter 6 - 12 GHz



MADL-011088-DIE
Rev. V1

Typical RF Power Performance, Die On-Board: $T_A = 25^\circ\text{C}$, $Z_0 = 50 \Omega$

CW Flat leakage Power over V_C Bias at 8 GHz

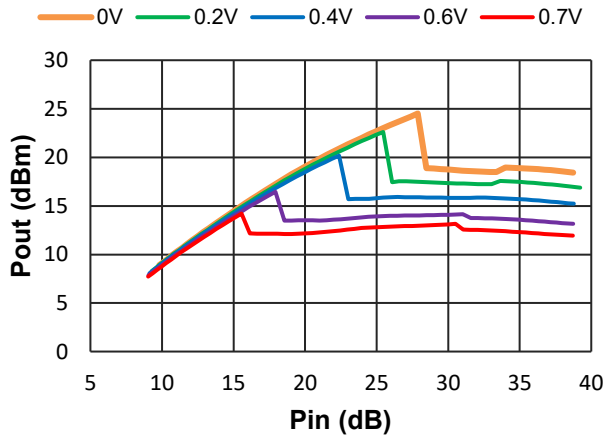

CW Flat leakage Power over V_C Bias at 10 GHz

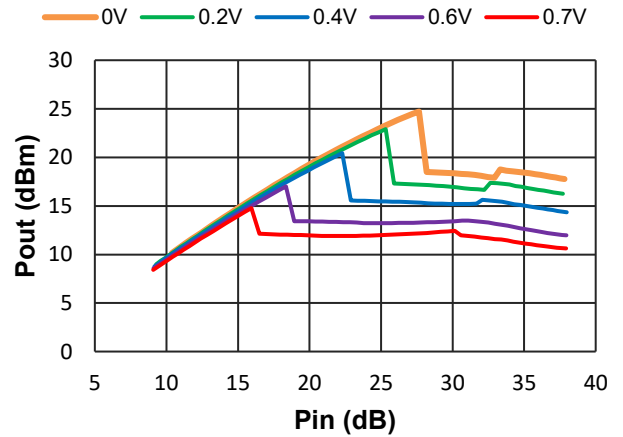

CW Flat leakage Power over V_C Bias at 12 GHz

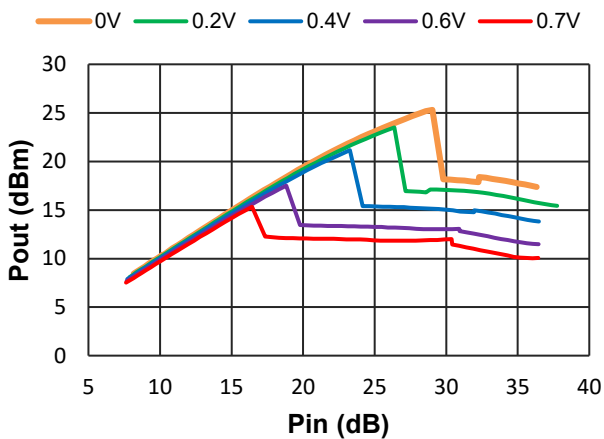

CW Flat leakage Power over Frequency at $V_C = 0.7 \text{ V}$

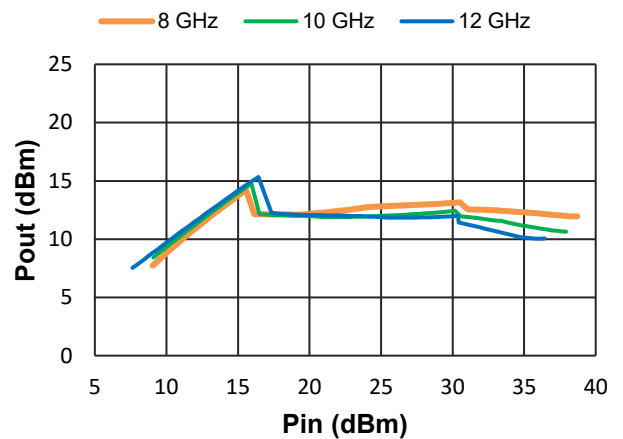

X-Band PIN Diode Limiter 6 - 12 GHz



MADL-011088-DIE
Rev. V1

Typical RF Power Performance, Die On-Board: $T_A = 25^\circ\text{C}$, $Z_0 = 50 \Omega$

Input IP3 over Frequency at $V_C = 0 \text{ V}$

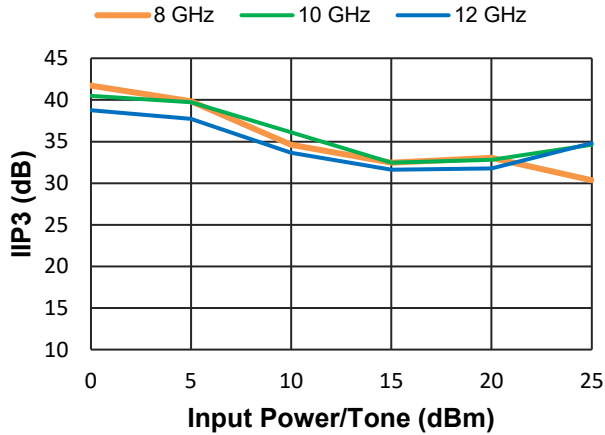

Input IP3 over V_C Bias at 8 GHz

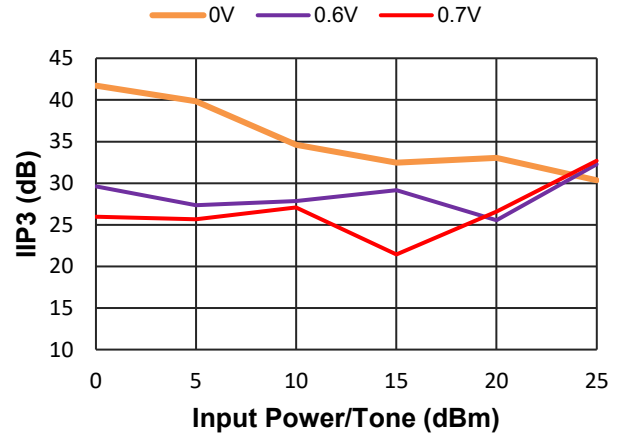

Input IP3 over V_C Bias at 10 GHz

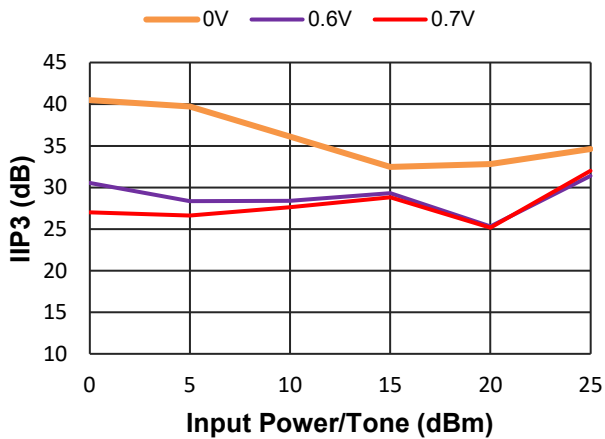

Input IP3 over V_C Bias at 12 GHz

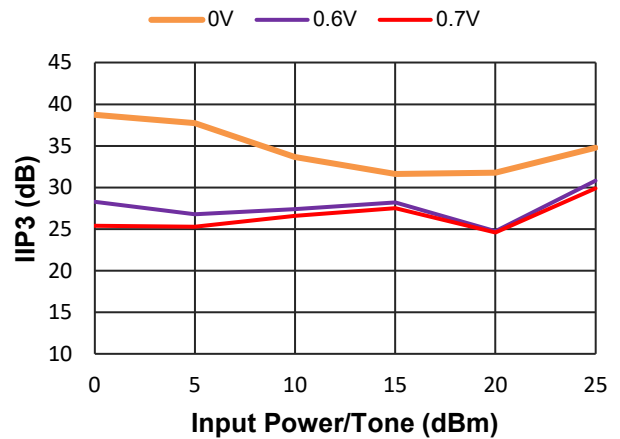

X-Band PIN Diode Limiter 6 - 12 GHz



MADL-011088-DIE

Rev. V1

Die Outline Drawing

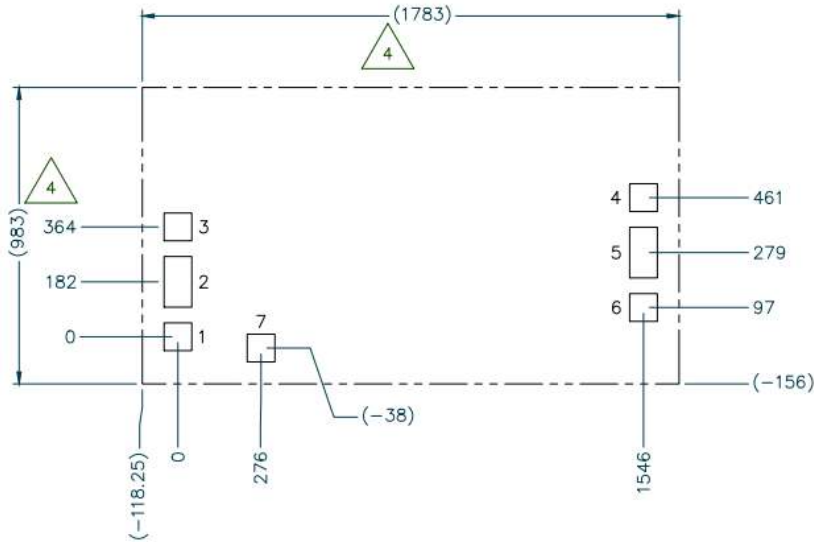

BOND PAD DIM (μm)			
PAD	X (μm)	Y (μm)	REF. DES.
1,3,4,6	100	100	GND
2	100	180	RF _{INPUT}
5	100	180	RF _{OUTPUT}
7	100	100	V _C

NOTES:

- UNLESS OTHERWISE SPECIFIED, ALL DIMENSIONS SHOWN ARE μm WITH A TOLERANCE OF $\pm 5\mu\text{m}$.
- DIE THICKNESS IS $100 \pm 10\mu\text{m}$
- BOND PAD/BACKSIDE METALLIZATION: GOLD.

4. OVERALL DIMENSIONS ARE FINAL, POST-SINGULATION, TOLERANCE $\pm 10\mu\text{m}$ EACH DIMENSION.

X-Band PIN Diode Limiter

6 - 12 GHz



MADL-011088-DIE

Rev. V1

MACOM Technology Solutions Inc. ("MACOM"). All rights reserved.

These materials are provided in connection with MACOM's products as a service to its customers and may be used for informational purposes only. Except as provided in its Terms and Conditions of Sale or any separate agreement, MACOM assumes no liability or responsibility whatsoever, including for (i) errors or omissions in these materials; (ii) failure to update these materials; or (iii) conflicts or incompatibilities arising from future changes to specifications and product descriptions, which MACOM may make at any time, without notice. These materials grant no license, express or implied, to any intellectual property rights.

THESE MATERIALS ARE PROVIDED "AS IS" WITH NO WARRANTY OR LIABILITY, EXPRESS OR IMPLIED, RELATING TO SALE AND/OR USE OF MACOM PRODUCTS INCLUDING FITNESS FOR A PARTICULAR PURPOSE, MERCHANTABILITY, INFRINGEMENT OF INTELLECTUAL PROPERTY RIGHT, ACCURACY OR COMPLETENESS, OR SPECIAL, INDIRECT, INCIDENTAL, OR CONSEQUENTIAL DAMAGES WHICH MAY RESULT FROM USE OF THESE MATERIALS.

MACOM products are not intended for use in medical, lifesaving or life sustaining applications. MACOM customers using or selling MACOM products for use in such applications do so at their own risk and agree to fully indemnify MACOM for any damages resulting from such improper use or sale.