

## Extrusion

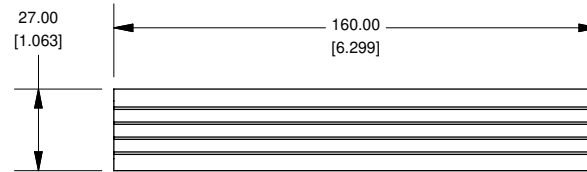

EXTRUSION DESIGNED FOR 75MM WIDE PC BOARD

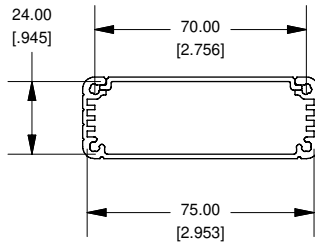
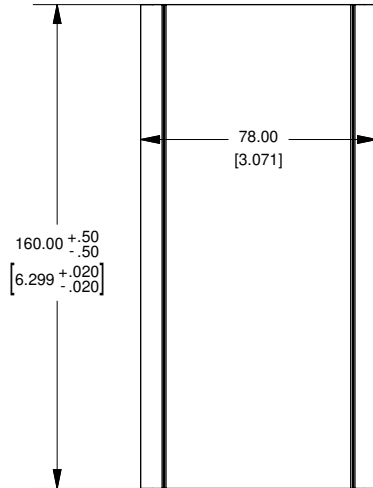

## Slot Details

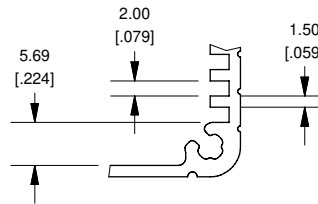

## Closed Bezel

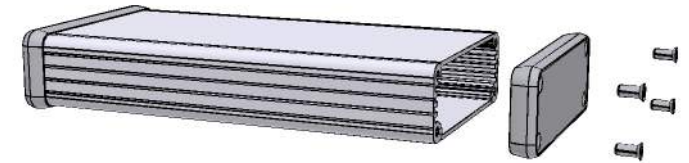
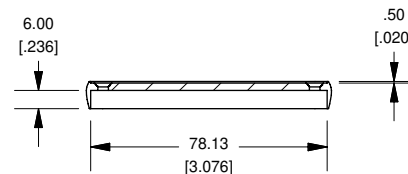
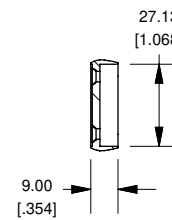
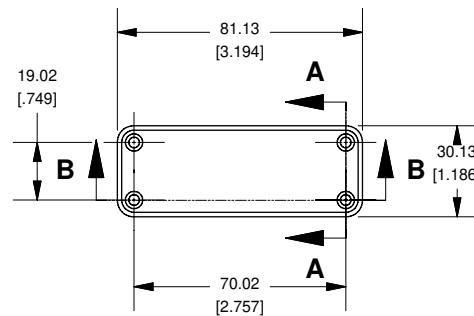

Enclosures can be Factory Modified ( Milling, Drilling, Printing etc. )  
Solid models of this enclosure available in STEP or IGES.  
Contact Factory [mjm@hammondmg.com](mailto:mjm@hammondmg.com)

### NOTE

Purchased assembly includes box, plastic bezels, #6 Taptight screws and self adhesive rubber feet.

Box made from Extruded Aluminum 6063.

Bezels made with ABS

### 1455J1202

#### PART NUMBERS

Clear Anodized	1455J1202
Black Anodized	1455J1602BK

#### ACCESSORIES

See website for accessories.

