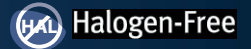

EPC2215 – Enhancement Mode Power Transistor

 V_{DS} , 200 V $R_{DS(on)}$, 8 mΩ I_D , 32 A

Gallium Nitride's exceptionally high electron mobility and low temperature coefficient allows very low $R_{DS(on)}$, while its lateral device structure and majority carrier diode provide exceptionally low Q_G and zero Q_{RR} . The end result is a device that can handle tasks where very high switching frequency, and low on-time are beneficial as well as those where on-state losses dominate.

Maximum Ratings

PARAMETER		VALUE	UNIT
V_{DS}	Drain-to-Source Voltage (Continuous)	200	V
I_D	Continuous ($T_A = 25^\circ\text{C}$)	32	A
	Pulsed (25°C , $T_{PULSE} = 300 \mu\text{s}$)	162	
V_{GS}	Gate-to-Source Voltage	6	V
	Gate-to-Source Voltage	-4	
T_J	Operating Temperature	-40 to 150	$^\circ\text{C}$
T_{STG}	Storage Temperature	-40 to 150	

Thermal Characteristics

PARAMETER		TYP	UNIT
$R_{\theta JC}$	Thermal Resistance, Junction-to-Case	0.5	$^\circ\text{C}/\text{W}$
$R_{\theta JB}$	Thermal Resistance, Junction-to-Board	2.5	
$R_{\theta JA}$	Thermal Resistance, Junction-to-Ambient (Note 1)	52	

Note 1: $R_{\theta JA}$ is determined with the device mounted on one square inch of copper pad, single layer 2 oz copper on FR4 board. See https://epc-co.com/epc/documents/product-training/Appnote_Thermal_Performance_of_eGaN_FETs.pdf for details.

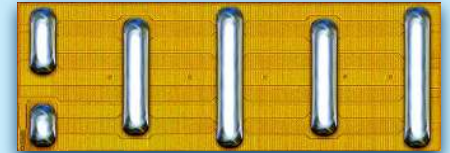

EPC2215 eGaN® FETs are supplied only in passivated die form with solder bars.
Die Size: 4.6 x 1.6 mm

Applications

- DC-DC Converters
- BLDC Motor Drives
- Sync Rectification for AC/DC and DC-DC
- Multi-level AC/DC Power Supplies
- Wireless Power
- Solar Micro Inverters
- Robotics
- Class-D Audio

Benefits

- Ultra High Efficiency
- No Reverse Recovery
- Ultra Low Q_G
- Small Footprint

Static Characteristics ($T_J = 25^\circ\text{C}$ unless otherwise stated)

PARAMETER		TEST CONDITIONS	MIN	TYP	MAX	UNIT
BV_{DSS}	Drain-to-Source Voltage	$V_{GS} = 0 \text{ V}$, $I_D = 0.6 \text{ mA}$	200			V
I_{DSS}	Drain-Source Leakage	$V_{GS} = 0 \text{ V}$, $V_{DS} = 160 \text{ V}$		0.15	0.48	mA
I_{GSS}	Gate-to-Source Forward Leakage	$V_{GS} = 5 \text{ V}$		0.03	3.8	
	Gate-to-Source Forward Leakage#	$V_{GS} = 5 \text{ V}$, $T_J = 125^\circ\text{C}$		0.5	8.7	
	Gate-to-Source Reverse Leakage	$V_{GS} = -4 \text{ V}$		0.15	0.48	
$V_{GS(TH)}$	Gate Threshold Voltage	$V_{DS} = V_{GS}$, $I_D = 6 \text{ mA}$	0.8	1.1	2.5	V
$R_{DS(on)}$	Drain-Source On Resistance	$V_{GS} = 5 \text{ V}$, $I_D = 20 \text{ A}$		6	8	mΩ
V_{SD}	Source-Drain Forward Voltage	$I_S = 0.5 \text{ A}$, $V_{GS} = 0 \text{ V}$		1.6		V

Defined by design. Not subject to production test.

Dynamic Characteristics ($T_j = 25^\circ\text{C}$ unless otherwise stated)

PARAMETER		TEST CONDITIONS	MIN	TYP	MAX	UNIT
C_{ISS}	Input Capacitance [#]	$V_{DS} = 100\text{ V}, V_{GS} = 0\text{ V}$		1356	1790	pF
C_{RSS}	Reverse Transfer Capacitance			2.0		
C_{OSS}	Output Capacitance [#]			390	585	
$C_{OSS(ER)}$	Effective Output Capacitance, Energy Related (Note 2)	$V_{DS} = 0\text{ to }100\text{ V}, V_{GS} = 0\text{ V}$		556		
$C_{OSS(TR)}$	Effective Output Capacitance, Time Related (Note 3)			699		
R_G	Gate Resistance			0.4		Ω
Q_G	Total Gate Charge [#]	$V_{DS} = 100\text{ V}, V_{GS} = 5\text{ V}, I_D = 20\text{ A}$		13.6	17.7	nC
Q_{GS}	Gate-to-Source Charge	$V_{DS} = 100\text{ V}, I_D = 20\text{ A}$		3.3		
Q_{GD}	Gate-to-Drain Charge			2.1		
$Q_{G(TH)}$	Gate Charge at Threshold			2.4		
Q_{OSS}	Output Charge [#]	$V_{DS} = 100\text{ V}, V_{GS} = 0\text{ V}$		69	104	
Q_{RR}	Source-Drain Recovery Charge			0		

Defined by design. Not subject to production test.

Note 2: $C_{OSS(ER)}$ is a fixed capacitance that gives the same stored energy as C_{OSS} while V_{DS} is rising from 0 to 50% BV_{DSS} .

Note 3: $C_{OSS(TR)}$ is a fixed capacitance that gives the same charging time as C_{OSS} while V_{DS} is rising from 0 to 50% BV_{DSS} .

Figure 1: Typical Output Characteristics at 25°C

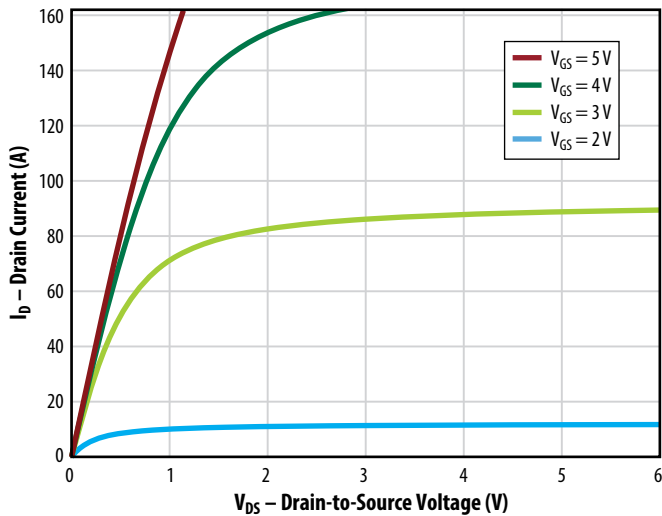

Figure 2: Transfer Characteristics

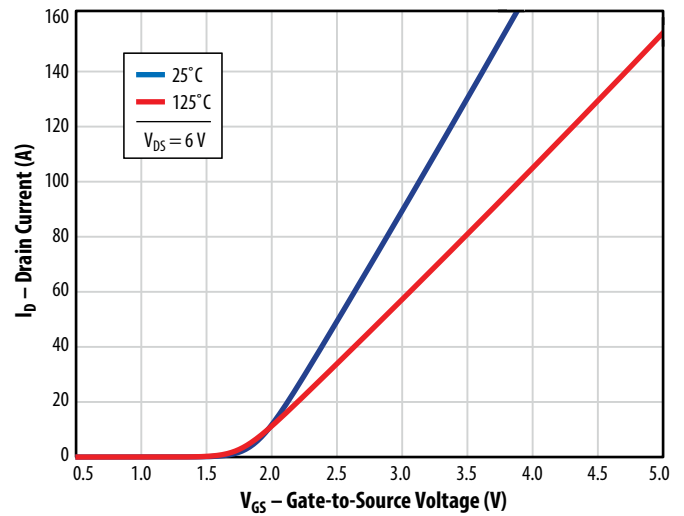

Figure 3: $R_{DS(on)}$ vs. V_{GS} for Various Drain Currents

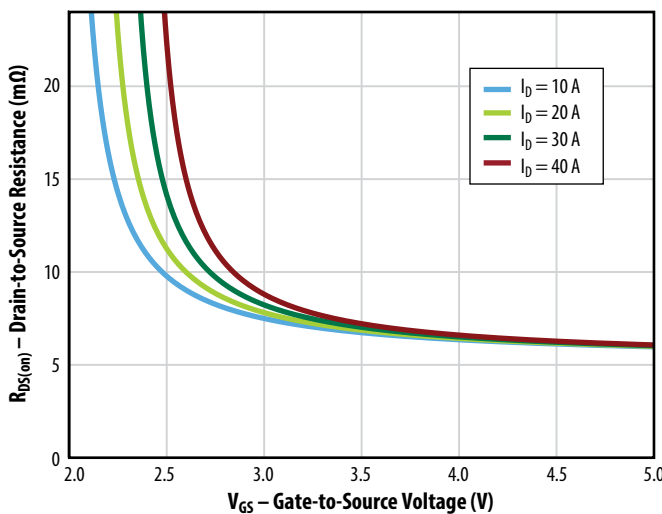

Figure 4: $R_{DS(on)}$ vs. V_{GS} for Various Temperatures

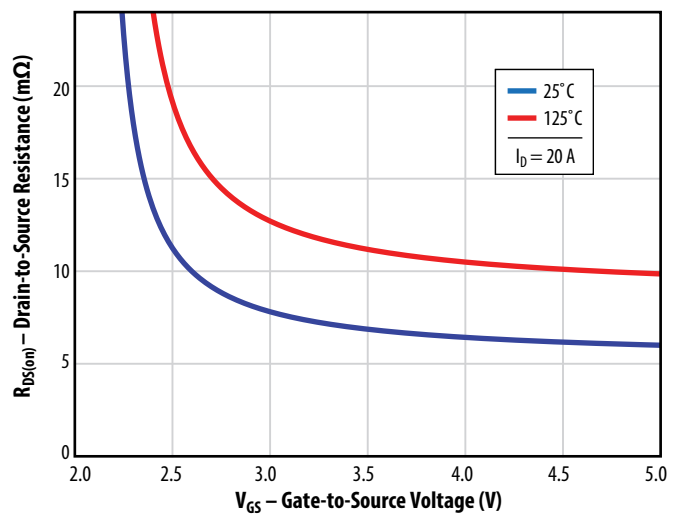

Figure 5a: Capacitance (Linear Scale)

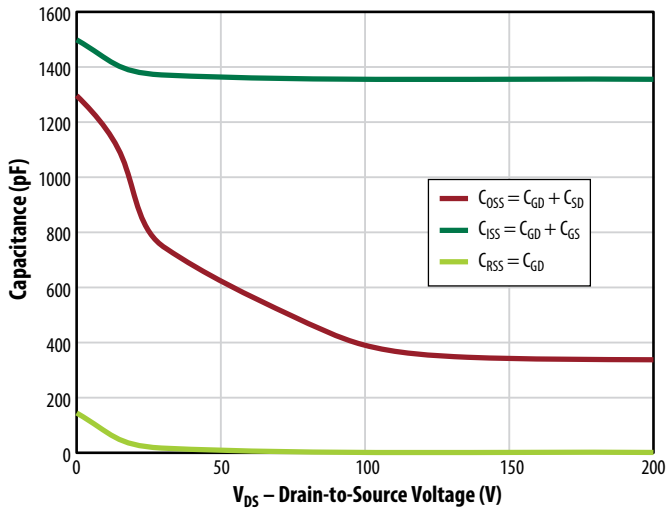

Figure 5b: Capacitance (Log Scale)

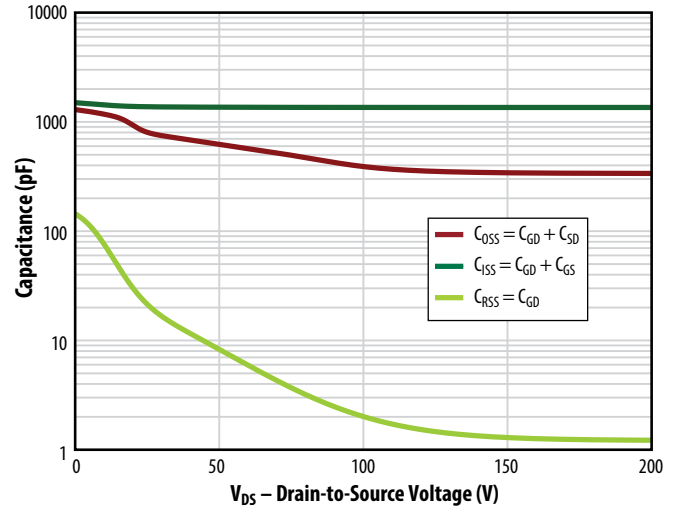

Figure 6: Output Charge and C_{OSS} Stored Energy

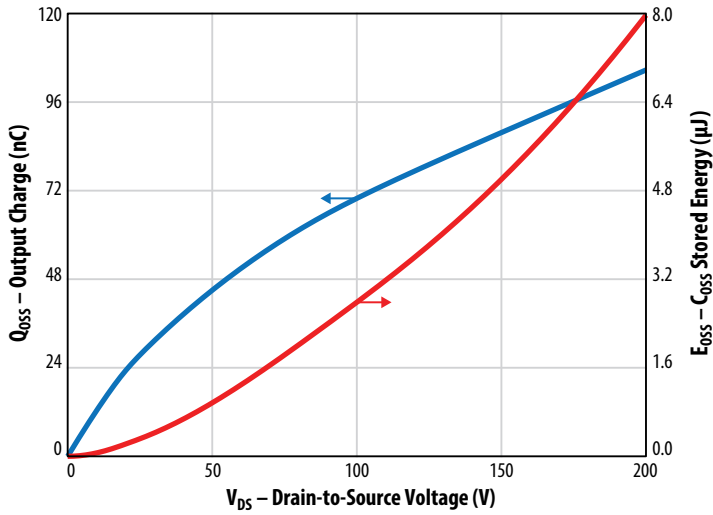

Figure 7: Gate Charge

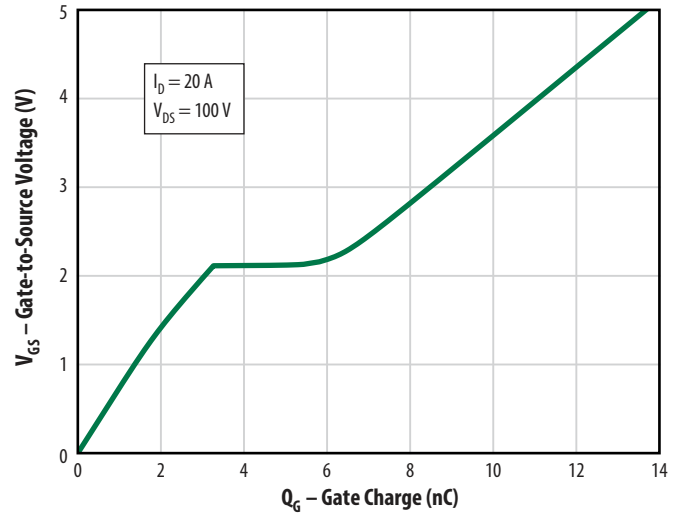

Figure 8: Reverse Drain-Source Characteristics

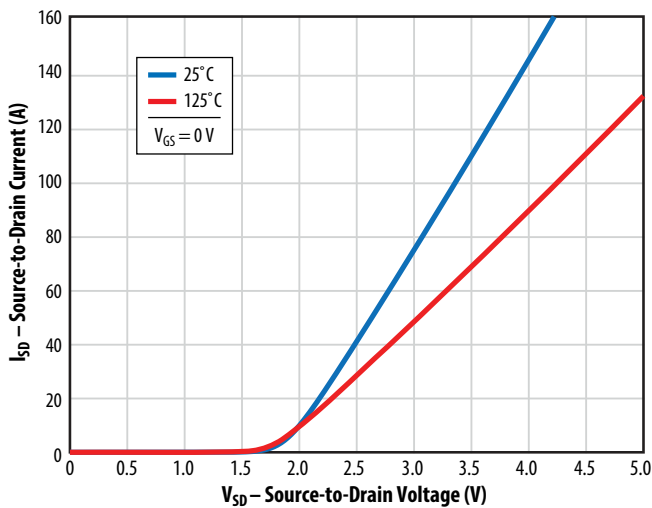

Figure 9: Normalized On-State Resistance vs. Temperature

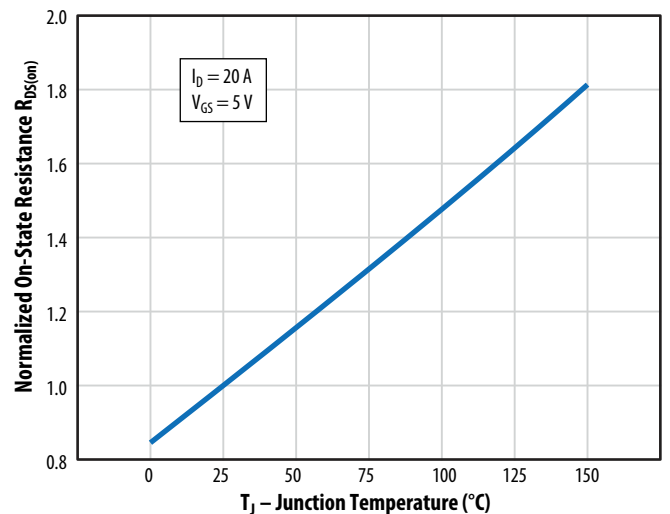

Figure 10: Normalized Threshold Voltage vs. Temperature

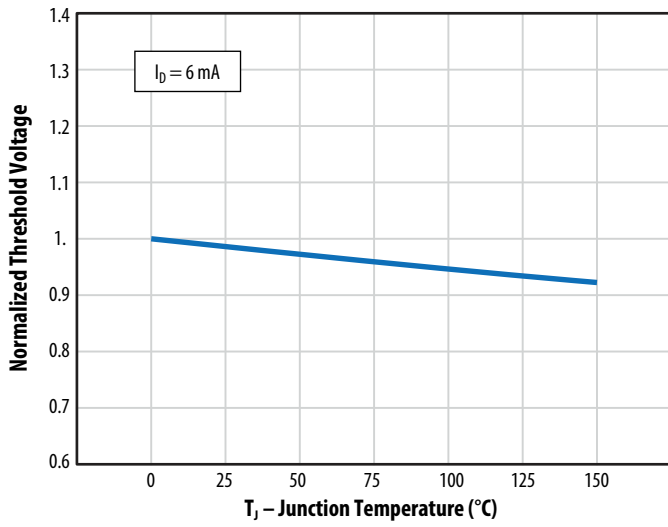

Figure 11: Safe Operating Area

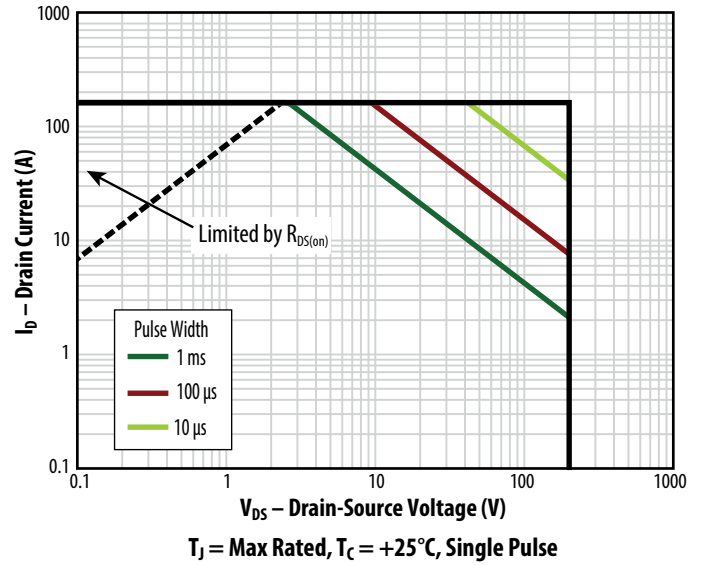
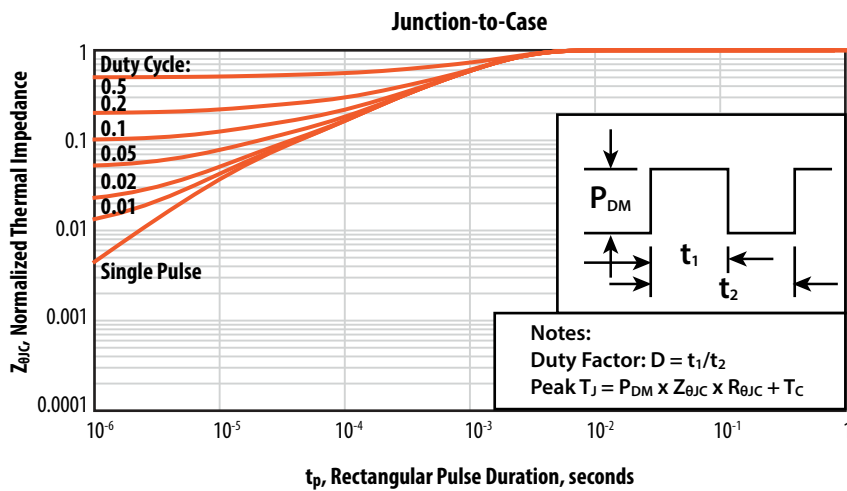
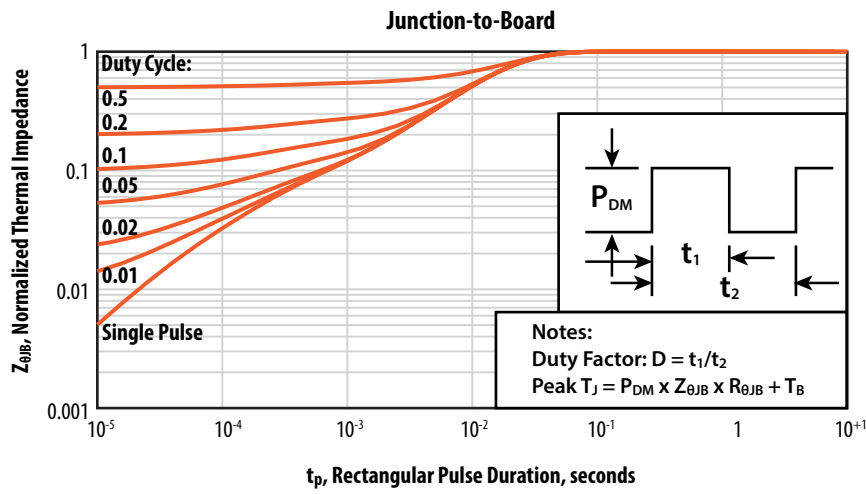
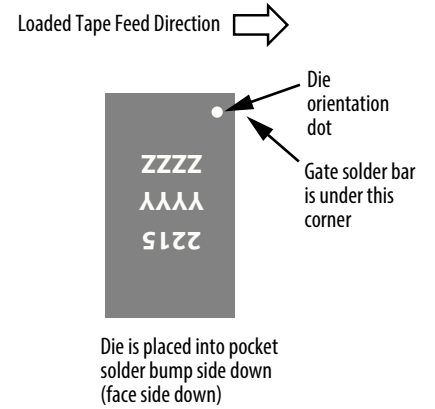
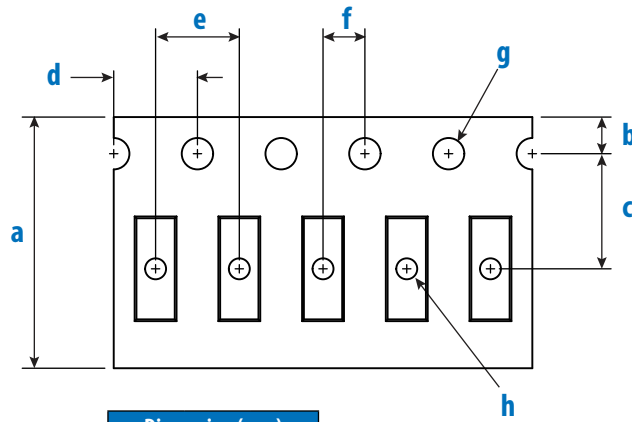
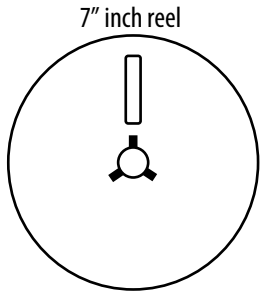

Figure 12: Transient Thermal Response Curves



TAPE AND REEL CONFIGURATION

4 mm pitch, 12 mm wide tape on 7" reel



EPC2215 (Note 1)	Dimension (mm)		
	Target	MIN	MAX
a	12.00	11.90	12.30
b	1.75	1.65	1.85
c (Note 2)	5.50	5.45	5.55
d	4.00	3.90	4.10
e	4.00	3.90	4.10
f (Note 2)	2.00	1.95	2.05
g	1.50	1.50	1.60
h	1.50	0.95	1.05

Note 1: MSL 1 (moisture sensitivity level 1) classified according to IPC/JEDEC industry standard.

Note 2: Pocket position is relative to the sprocket hole measured as true position of the pocket, not the pocket hole.

DIE MARKINGS

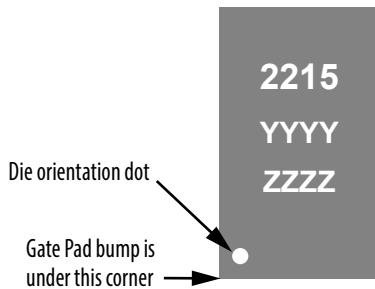

Part Number	Laser Markings		
	Part # Marking Line 1	Lot_Date Code Marking Line 2	Lot_Date Code Marking Line 3
EPC2215	2215	YYYY	ZZZZ

DIE OUTLINE

Solder Bump View

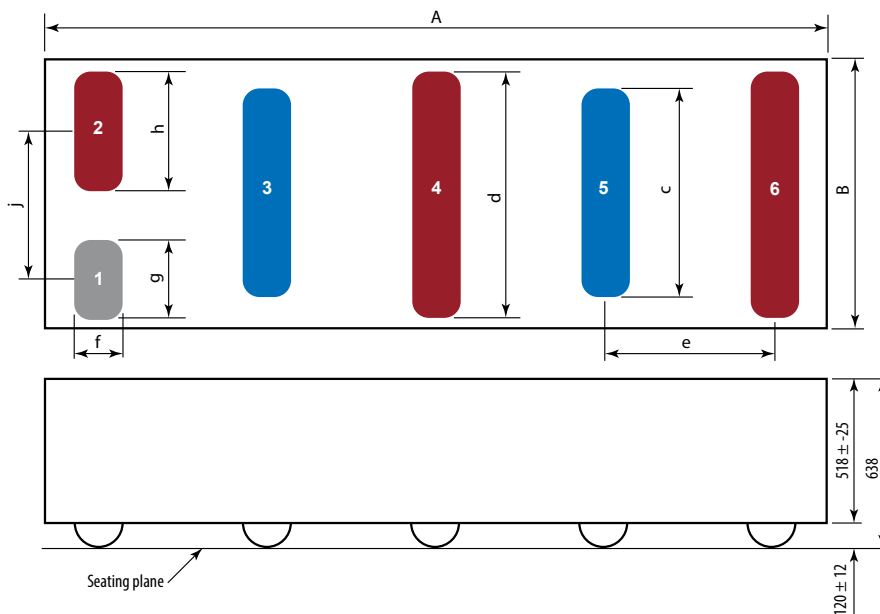

DIM	Micrometers		
	MIN	Nominal	MAX
A	4570	4600	4630
B	1570	1600	1630
c		1210	
d		1450	
e		1000	
f		275	
g		450	
h		700	
j		875	

Pad 1 is Gate;
 Pads 2, 4, 6 are Source;
 Pads 3, 5 are Drain

RECOMMENDED LAND PATTERN
(units in μm)

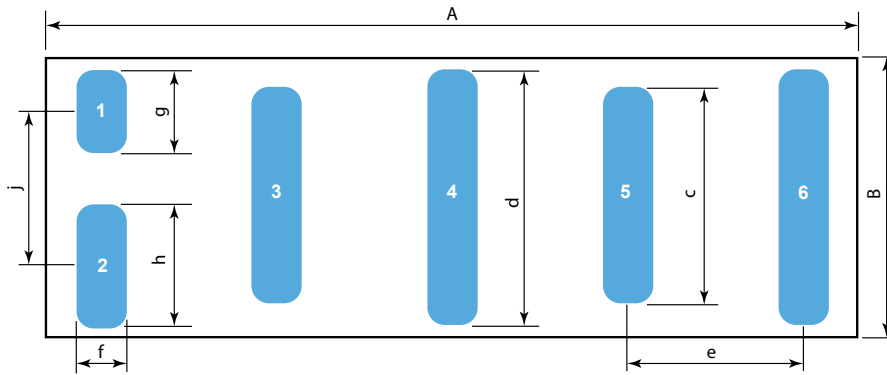

Land pattern is solder mask defined
It is recommended to have on-Cu trace PCB vias

Pad 1 is Gate;
Pads 2, 4, 6
are Source;
Pads 3, 5 are Drain

DIM	Nominal
A	4600
B	1600
c	1210
d	1450
e	1000
f	275
g	450
h	700
j	875

RECOMMENDED STENCIL DRAWING
(units in μm)

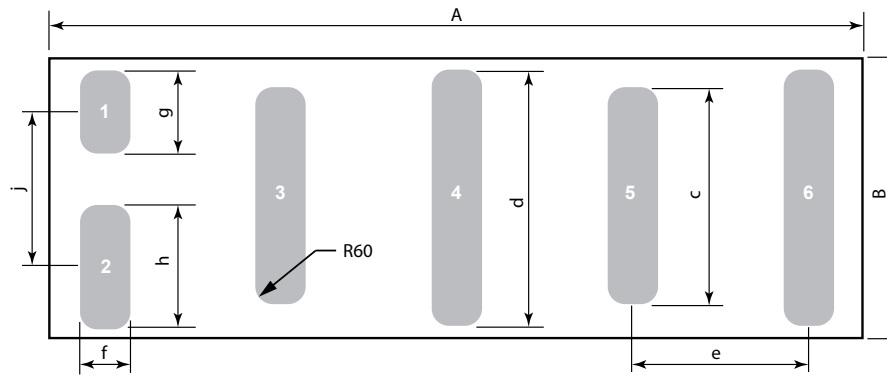

DIM	Nominal
A	4600
B	1600
c	1210
d	1450
e	1000
f	275
g	450
h	700
j	875

Recommended stencil should be 4 mil (100 μm) thick, must be laser cut, openings per drawing.

The corner has a radius of R60.

Intended for use with SAC305 Type 3 solder, reference 88.5% metals content.

Split stencil design can be provided upon request, but EPC has tested this stencil design and not found any scooping issues.

Additional assembly resources available at <https://epc-co.com/epc/DesignSupport/AssemblyBasics.aspx>

Efficient Power Conversion Corporation (EPC) reserves the right to make changes without further notice to any products herein to improve reliability, function or design. EPC does not assume any liability arising out of the application or use of any product or circuit described herein; neither does it convey any license under its patent rights, nor the rights of others.

eGaN® is a registered trademark of Efficient Power Conversion Corporation.
EPC Patent Listing: <https://epc-co.com/epc/about-epc/patents>

Information subject to change without notice.
Revised June, 2023