

# 3M™ Mini-Clamp Socket

2 mm, Surfacemount, Right Angle

372 Series



- Low profile design minimizes overall thickness
- Compact design saves board space
- Multiple PCB locating post layouts to ensure competitive compatibility
- Solder tab design helps ensure a reliable solder joint
- Mating Latch feature provides a reliable interconnection in demanding applications
- High number of mating cycles (300)
- Maximum current rating of 3 Amps
- Dust cover accessory available for use in harsh environment
- Available in Tape and Reel
- RoHS Compliant. See the Regulatory Information Appendix (RIA) in the “RoHS compliance” section of [www.3Mconnector.com](http://www.3Mconnector.com) for compliance information (RIA E1 & C1 apply)

Date Modified: July 14, 2011

TS-2271-C  
Sheet 1 of 4

## Physical

### Insulation:

Material: LCP  
Flammability: UL 94V-0  
Color: Black

### Contact:

Material: Copper Alloy

### Plating:

Underplating: 100 μ" [2.54 μm] Ni  
Wiping Area: 0.2 μm [8 μ"] min Gold with Lubricant  
Solder Tails: Gold Flash  
Solder Tabs: 120 μ" min [3 μm min] Matte Sn over 40 μ"-120 μ" [1-3 μm] Ni

**Marking:** 3M Logo, Position Indicator, Insulator Material

**Mating Compatibility:** 371 Series

## Electrical

**Current Rating:** 3.0 A

**Voltage Rating:** 32 V

**Insulation Resistance:** 1,000 MΩ minimum at 500 V<sub>DC</sub>

**Withstanding Voltage:** 1,000 V<sub>RMS</sub> for 1 minute

## Environmental

**Temperature Rating:** -20°C to +85°C ambient (1.0 A max.)  
-20°C to +75°C ambient (2.0 A max.)  
-20°C to +60°C ambient (3.0 A max.)  
(Note: UL rating is 65 C at 3.0 A, 32 V)

**Process Rating:** 260°C max. SMT reflow (J-STD-020 MSL1)  
390°C max. for soldering iron

UL File No.: E68080

**3M**

Electronic Solutions Division  
Interconnect Solutions  
<http://www.3Mconnector.com>

3M is a trademark of 3M Company.  
For technical, sales or ordering information call  
**800-225-5373**

# 3M™ Mini-Clamp Socket

2 mm, Surfacemount, Right Angle

372 Series

## 3 and 4 Position Socket

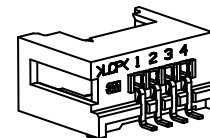
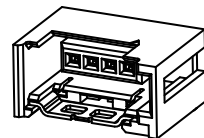
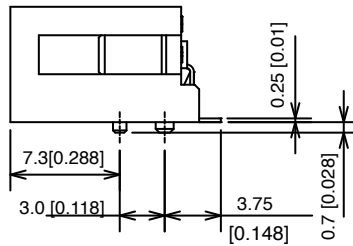
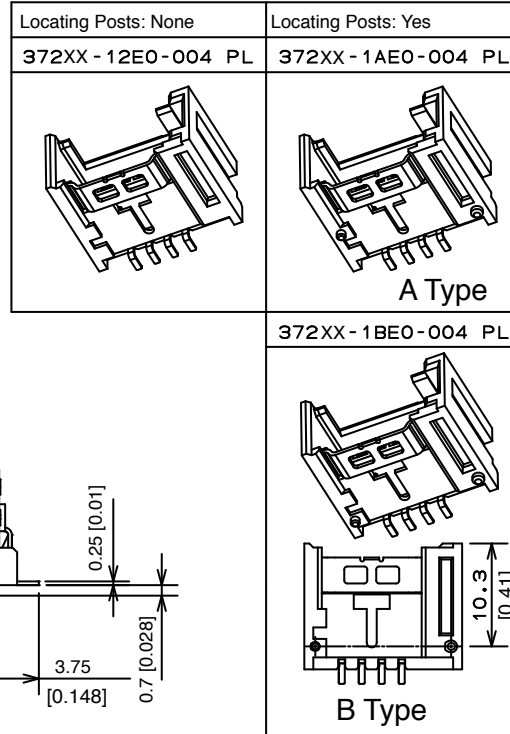
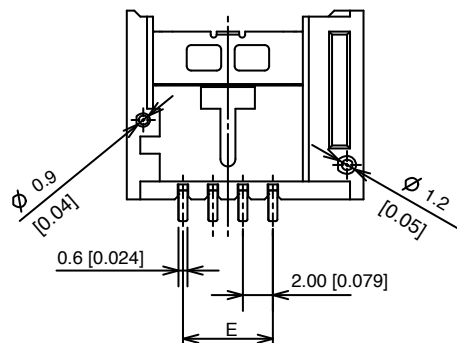
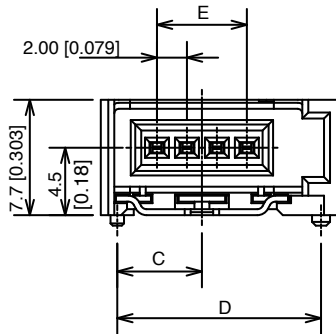
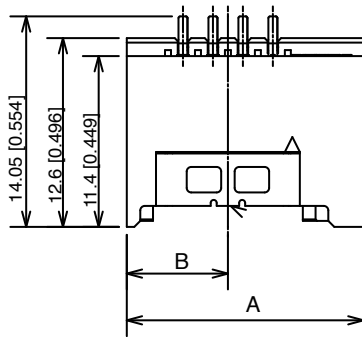

Pins	A	B	C	D	E
3	13.8 [0.54]	5.75 [.23]	4.65 [0.18]	11.6 [0.46]	4.00 [0.157]
4	15.8 [0.62]	6.75 [0.27]	5.65 [0.22]	13.6 [0.54]	6.00 [0.236]

mm [inch]			
Tolerance Unless Noted			
	.0	.00	.000
mm	±.3	±.13	

[ ], ( ) Dimensions for Reference Only

## Ordering Information

Available Combinations

- 37203-1AE0-003 PL
- 37203-1BE0-003 PL
- 37203-12E0-003 PL
- 37204-1AE0-004 PL
- 37204-1BE0-004 PL
- 37204-12E0-004 PL

**372XX-1XE0-00X PL** (RIA E1 and C1 Apply)

Positions  
03 or 04

Locating Posts  
A = Asymmetric  
B = Symmetric  
2 = None

Mating Plug Size  
3 or 4

TS-2271-C  
Sheet 2 of 4



Electronic Solutions Division  
Interconnect Solutions  
<http://www.3Mconnector.com>

3M is a trademark of 3M Company.  
For technical, sales or ordering information call  
**800-225-5373**

# 3M™ Mini-Clamp Socket

2 mm, Surfacement, Right Angle

372 Series

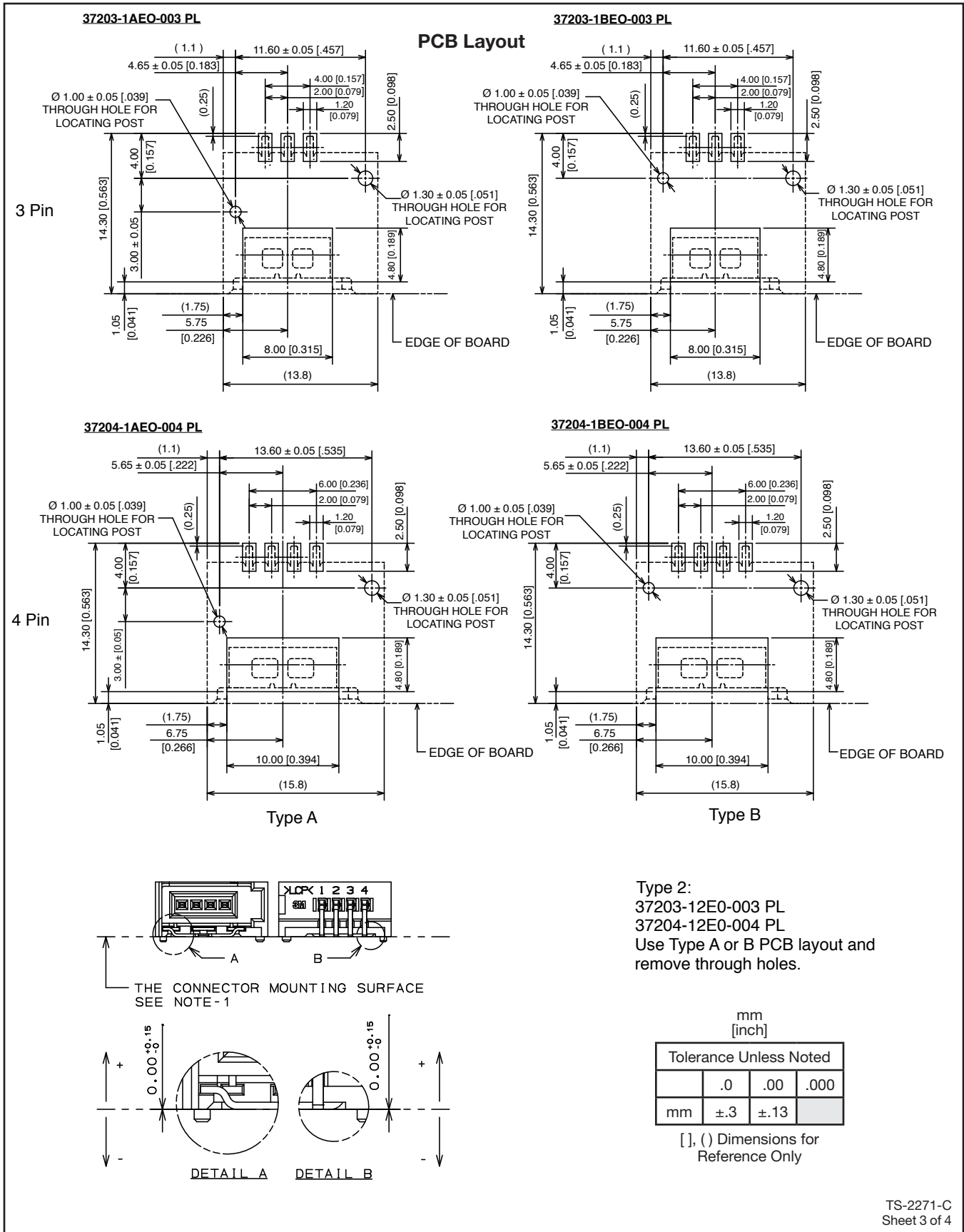

TS-2271-C  
 Sheet 3 of 4

# 3M™ Mini-Clamp Socket

2 mm, Surfacement, Right Angle

372 Series

## Tape and Reel Packaging

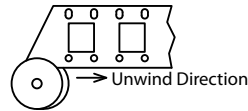
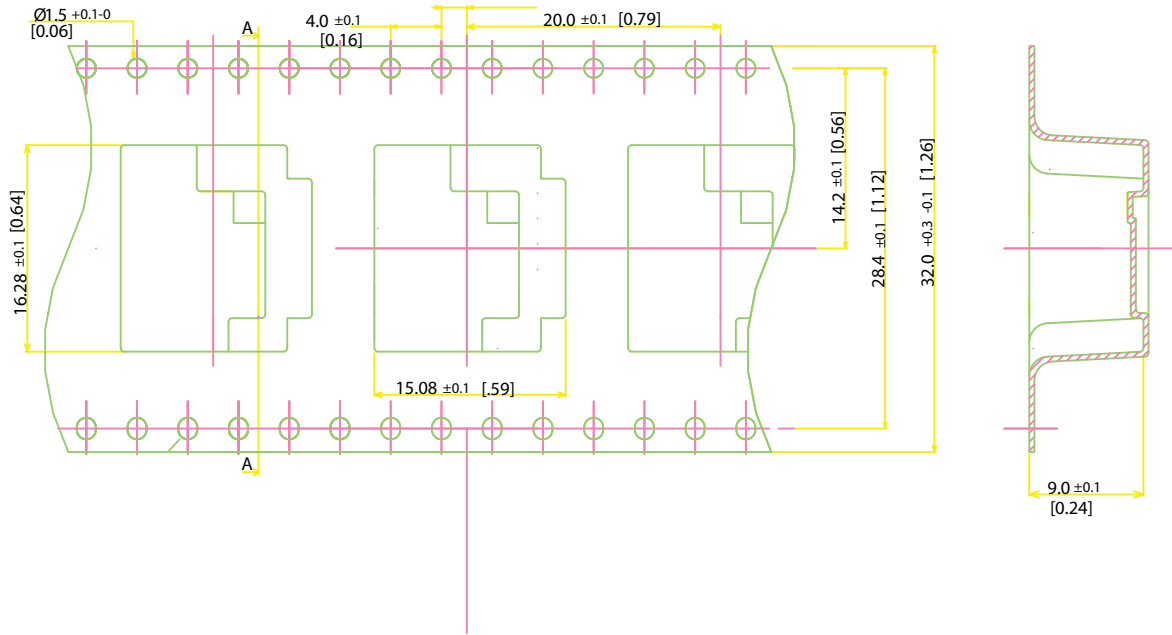

## Accessories

### Dust Cover Accessory



### Ordering Information:

3 pos - 37803-1000-00

4 pos - 37804-1000-00

TS-2271-C  
Sheet 4 of 4