

# HFA1150

700MHz, SOT-23, Low Distortion Current Feedback Operational Amplifier

FN4836  
Rev 1.00  
June 2004

The HFA1150 is a high-speed, wideband, fast settling op amp built with Intersil's proprietary complementary bipolar UHF-1 process. The current feedback architecture delivers superb bandwidth even at very high gains (>300MHz at  $A_V = 10$ ), and the low distortion and excellent video parameters make this amplifier ideal for communication and professional video applications.

Though specified for  $\pm 5V$  operation, the HFA1150 operates with single supply voltages as low as 4.5V, and requires only 3.4mA of  $I_{CC}$  in 5V applications (see Application Information section, and Application Note AN9891).

For a lower power amplifier in a SOT-23 package, please refer to the HFA1155 data sheet.

## Part # Information

PART NUMBER (BRAND)	TEMP. RANGE (°C)	PACKAGE	PKG. NO.
HFA1150IB (H1150I)	-40 to 85	8 Ld SOIC	M8.15
HFA1150IB96 (H1150I)	-40 to 85	8 Ld SOIC Tape and Reel	M8.15
HFA1150IH96 (1150)	-40 to 85	5 Ld SOT-23 Tape and Reel	P5.064
HFA11XXEVAL	DIP Evaluation Board for High-Speed Op Amps		
OPAMPSOT23EVAL	SOT-23 Evaluation Board for High-Speed Op Amps		

## Features

- Low Distortion (5MHz, HD2) ..... -67dBc
- a-3dB Bandwidth ..... 700MHz
- High Slew Rate ..... 2700V/ $\mu$ s
- Fast Settling Time (0.1%)..... 20ns
- Excellent Gain Flatness .....  $\pm 0.05$ dB to 100MHz
- High Output Current..... 60mA
- Fast Overdrive Recovery ..... <5ns
- Operates with 5V Single Supply (See AN9891)

## Applications

- Video Switching and Routing
- Pulse and Video Amplifiers
- RF/IF Signal Processing
- Flash A/D Driver
- Medical Imaging Systems
- Related Literature
  - AN9420, Current Feedback Theory
  - AN9891, Single 5V Supply Operation

## Pinouts

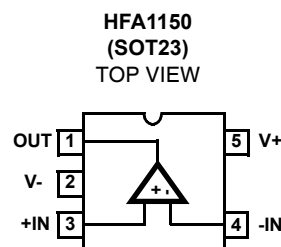
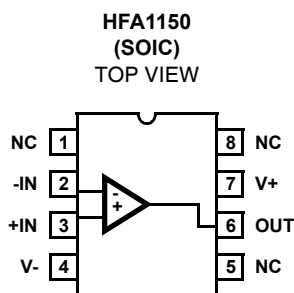

**Absolute Maximum Ratings**  $T_A = 25^{\circ}\text{C}$ 

Voltage Between V+ and V- . . . . .	12V
Input Voltage . . . . .	$V_{\text{SUPPLY}}$
Differential Input Voltage . . . . .	5V
Output Current (50% Duty Cycle) . . . . .	60mA
ESD Rating	
Human Body Model (Per MIL-STD-883 Method 3015.7) . . . . .	600V

**Operating Conditions**

Temperature Range . . . . .	$-40^{\circ}\text{C}$ to $85^{\circ}\text{C}$
-----------------------------	---

**Thermal Information**

Thermal Resistance (Typical, Note 1) $\theta_{\text{JA}}$ ( $^{\circ}\text{C}/\text{W}$ )	
SOIC Package . . . . .	175
SOT-23 Package . . . . .	225
Moisture Sensitivity (see Technical Brief TB363)	
SOIC Package . . . . .	Level 1
SOT-23 Package . . . . .	Level 1
Maximum Junction Temperature (Plastic Package) . . . . .	$150^{\circ}\text{C}$
Maximum Storage Temperature Range . . . . .	$-65^{\circ}\text{C}$ to $150^{\circ}\text{C}$
Maximum Lead Temperature (Soldering 10s) . . . . .	$300^{\circ}\text{C}$ (Lead Tips Only)

**CAUTION:** Stresses above those listed in "Absolute Maximum Ratings" may cause permanent damage to the device. This is a stress only rating and operation of the device at these or any other conditions above those indicated in the operational sections of this specification is not implied.

**NOTE:**

- $\theta_{\text{JA}}$  is measured with the component mounted on an evaluation PC board in free air.

**Electrical Specifications**  $V_{\text{SUPPLY}} = \pm 5\text{V}$ ,  $A_V = 1$ ,  $R_F = 510\Omega$ ,  $R_L = 100\Omega$ , Unless Otherwise Specified

PARAMETER	TEST CONDITIONS	(NOTE 2) TEST LEVEL	TEMP. ( $^{\circ}\text{C}$ )	HFA1150IB (SOIC)			HFA1150IH (SOT-23)			UNITS
				MIN	TYP	MAX	MIN	TYP	MAX	
<b>INPUT CHARACTERISTICS</b>										
Input Offset Voltage (Note 3)		A	25	-	2	6	-	2	6	mV
		A	Full	-	-	10	-	-	10	mV
Input Offset Voltage Drift		C	Full	-	10	-	-	10	-	$\mu\text{V}/^{\circ}\text{C}$
$V_{\text{IO}}$ CMRR	$\Delta V_{\text{CM}} = \pm 2\text{V}$	A	25	40	46	-	40	46	-	dB
		A	Full	38	-	-	38	-	-	dB
$V_{\text{IO}}$ PSRR	$\Delta V_{\text{S}} = \pm 1.25\text{V}$	A	25	45	50	-	45	50	-	dB
		A	Full	42	-	-	42	-	-	dB
Non-Inverting Input Bias Current (Note 3)	+IN = 0V	A	25	-	25	40	-	25	40	$\mu\text{A}$
		A	Full	-	-	65	-	-	65	$\mu\text{A}$
+I <sub>BIAS</sub> Drift		C	Full	-	40	-	-	40	-	$\text{nA}/^{\circ}\text{C}$
+I <sub>BIAS</sub> CMS	$\Delta V_{\text{CM}} = \pm 2\text{V}$	A	25	-	20	40	-	20	40	$\mu\text{A}/\text{V}$
		A	Full	-	-	50	-	-	50	$\mu\text{A}/\text{V}$
Inverting Input Bias Current (Note 3)	-IN = 0V	A	25	-	12	50	-	12	50	$\mu\text{A}$
		A	Full	-	-	60	-	-	60	$\mu\text{A}$
-I <sub>BIAS</sub> Drift		C	Full	-	40	-	-	40	-	$\text{nA}/^{\circ}\text{C}$
-I <sub>BIAS</sub> CMS	$\Delta V_{\text{CM}} = \pm 2\text{V}$	A	25	-	1	7	-	1	7	$\mu\text{A}/\text{V}$
		A	Full	-	-	10	-	-	10	$\mu\text{A}/\text{V}$
-I <sub>BIAS</sub> PSS	$\Delta V_{\text{S}} = \pm 1.25\text{V}$	A	25	-	6	15	-	6	15	$\mu\text{A}/\text{V}$
		A	Full	-	-	27	-	-	27	$\mu\text{A}/\text{V}$
Non-Inverting Input Resistance		A	25	25	50	-	25	50	-	k $\Omega$
Inverting Input Resistance		C	25	-	25	-	-	25	-	$\Omega$
Input Capacitance (Either Input)		B	25	-	2	-	-	2	-	pF
Input Common Mode Range		C	Full	$\pm 2.5$	$\pm 3.0$	-	$\pm 2.5$	$\pm 3.0$	-	V
Input Noise Voltage (Note 3)	100kHz	B	25	-	4.7	-	-	4.7	-	$\text{nV}/\sqrt{\text{Hz}}$
+Input Noise Current (Note 3)	100kHz	B	25	-	20	-	-	20	-	$\text{pA}/\sqrt{\text{Hz}}$
-Input Noise Current (Note 3)	100kHz	B	25	-	40	-	-	40	-	$\text{pA}/\sqrt{\text{Hz}}$
<b>TRANSFER CHARACTERISTICS</b>										
Open Loop Transimpedance Gain (Note 3)		B	25	-	450	-	-	450	-	k $\Omega$
Minimum Stable Gain		A	Full	1	-	-	1	-	-	V/V

**Electrical Specifications**  $V_{SUPPLY} = \pm 5V$ ,  $A_V = 1$ ,  $R_F = 510\Omega$ ,  $R_L = 100\Omega$ , Unless Otherwise Specified (Continued)

PARAMETER	TEST CONDITIONS	(NOTE 2) TEST LEVEL	TEMP. (°C)	HFA1150IB (SOIC)			HFA1150IH (SOT-23)			UNITS	
				MIN	TYP	MAX	MIN	TYP	MAX		
<b>AC CHARACTERISTICS</b> $A_V = +2$ , (Note 4) Unless Otherwise Specified											
-3dB Bandwidth ( $V_{OUT} = 0.2V_{P-P}$ , Note 3)	$A_V = -1$	B	25	-	650	-	-	540	-	MHz	
	$A_V = +1$	B	25	-	600	-	-	500	-	MHz	
	$A_V = +2$	B	25	-	700	-	-	540	-	MHz	
-3dB Bandwidth ( $V_{OUT} = 2V_{P-P}$ )	$A_V = +2$	B	25	-	375	-	-	350	-	MHz	
Gain Flatness ( $V_{OUT} = 0.2V_{P-P}$ , Note 3)	To 25MHz	B	25	-	$\pm 0.03$	-	-	$\pm 0.05$	-	dB	
	To 50MHz	B	25	-	$\pm 0.04$	-	-	$\pm 0.08$	-	dB	
	To 100MHz	B	25	-	$\pm 0.05$	-	-	$\pm 0.1$	-	dB	
Full Power Bandwidth ( $V_{OUT} = 5V_{P-P}$ , Note 3)	$A_V = +1$	B	25	-	100	-	-	90	-	MHz	
	$A_V = +2$	B	25	-	175	-	-	160	-	MHz	
<b>OUTPUT CHARACTERISTICS</b> $A_V = +2$ , (Note 4) Unless Otherwise Specified											
Output Voltage	$A_V = -1$	A	25	$\pm 3.0$	$\pm 3.3$	-	-	$\pm 3.0$	$\pm 3.3$	-	V
		A	Full	$\pm 2.5$	$\pm 3.0$	-	-	$\pm 2.5$	$\pm 3.0$	-	V
Output Current	$R_L = 50\Omega$ , $A_V = -1$	A	25, 85	$\pm 50$	$\pm 60$	-	-	$\pm 50$	$\pm 60$	-	mA
		A	-40	$\pm 35$	$\pm 50$	-	-	$\pm 35$	$\pm 50$	-	mA
DC Closed Loop Output Impedance (Note 3)		B	25	-	0.07	-	-	0.07	-	$\Omega$	
2nd Harmonic Distortion (Note 3)	5MHz, $V_{OUT} = 2V_{P-P}$	B	25	-	-67	-	-	-67	-	dBc	
	30MHz, $V_{OUT} = 2V_{P-P}$	B	25	-	-53	-	-	-53	-	dBc	
3rd Harmonic Distortion (Note 3)	5MHz, $V_{OUT} = 2V_{P-P}$	B	25	-	<-100	-	-	<-100	-	dBc	
	30MHz, $V_{OUT} = 2V_{P-P}$	B	25	-	-76	-	-	-76	-	dBc	
<b>TRANSIENT CHARACTERISTICS</b> $A_V = +2$ , (Note 4) Unless Otherwise Specified											
Rise and Fall Times	$V_{OUT} = 0.5V_{P-P}$	B	25	-	0.6	-	-	0.7	-	ns	
Overshoot	$V_{OUT} = 0.5V_{P-P}$	B	25	-	12	-	-	12	-	%	
Slew Rate ( $V_{OUT} = 5V_{P-P}$ )	$A_V = -1$	B	25	-	2700	-	-	2500	-	V/ $\mu$ s	
	$A_V = +1$	B	25	-	750	-	-	700	-	V/ $\mu$ s	
	$A_V = +2$	B	25	-	1300	-	-	1200	-	V/ $\mu$ s	
Settling Time ( $V_{OUT} = 2V$ to $0V$ , Note 3)	To 0.1%	B	25	-	20	-	-	30	-	ns	
	To 0.05%	B	25	-	33	-	-	37	-	ns	
	To 0.01%	B	25	-	55	-	-	60	-	ns	
Overdrive Recovery Time	$V_{IN} = \pm 2V$	B	25	-	5	-	-	5	-	ns	
<b>VIDEO CHARACTERISTICS</b> $A_V = +2$ , (Note 4) Unless Otherwise Specified											
Differential Gain	NTSC, $R_L = 150\Omega$	B	25	-	0.02	-	-	0.02	-	%	
	NTSC, $R_L = 75\Omega$	B	25	-	0.04	-	-	0.04	-	%	
Differential Phase	NTSC, $R_L = 150\Omega$	B	25	-	0.03	-	-	0.03	-	Degrees	
	NTSC, $R_L = 75\Omega$	B	25	-	0.06	-	-	0.06	-	Degrees	
<b>POWER SUPPLY CHARACTERISTICS</b>											
Power Supply Range	Note 5	B	Full	$\pm 2.25$	-	$\pm 5.5$	$\pm 2.25$	-	$\pm 5.5$	V	
Power Supply Current (Note 3)		A	Full	-	12	16	-	12	16	mA	

## NOTES:

2. Test Level: A. Production Tested; B. Typical or Guaranteed Limit Based on Characterization; C. Design Typical for Information Only.
3. See Typical Performance Curves for more information.
4. The feedback resistor value depends on closed loop gain and package type. See the "Optimum Feedback Resistor" table in the Application Information section for values used for characterization.
5. The minimum supply voltage entry is a typical value.

## Application Information

### Relevant Application Notes

The following Application Notes pertain to the HFA1150:

- AN9787 - An Intuitive Approach to Understanding Current Feedback Amplifiers
- AN9420 - Current Feedback Amplifier Theory and Applications
- AN9663-Converting from Voltage Feedback to Current Feedback Amplifiers
- AN9891-Operating the HFA1150 from 5V Single Supply

These publications may be obtained from Intersil's web site (<http://www.intersil.com>).

### Performance Differences Between Packages

The HFA1150 is a high frequency current feedback amplifier. As such, it is sensitive to parasitic capacitances which influence the amplifier's operation. The different parasitic capacitances of the SOIC and SOT-23 packages yield performance differences (notably bandwidth and bandwidth related parameters) between the two devices - see Electrical Specification tables for details.

Because of these performance differences, designers should evaluate and breadboard with the same package style to be used in production.

Note that some "Typical Performance Curves" have separate graphs for each package type. Graphs not labeled with a specific package type are applicable to both packages.

### Optimum Feedback Resistor

The enclosed frequency response graphs detail the performance of the HFA1150 in various gains. Although the bandwidth dependency on  $A_{CL}$  isn't as severe as that of a voltage feedback amplifier, there is an appreciable decrease in bandwidth at higher gains. This decrease can be minimized by taking advantage of the current feedback amplifier's unique relationship between bandwidth and  $R_F$ . All current feedback amplifiers require a feedback resistor, even for unity gain applications, and the  $R_F$ , in conjunction with the internal compensation capacitor, sets the dominant pole of the frequency response. Thus, the amplifier's bandwidth is inversely proportional to  $R_F$ . The HFA1150 is optimized for a  $R_F = 576\Omega/499\Omega$  (SOIC/SOT-23), at a gain of +2. Decreasing  $R_F$  decreases stability, resulting in excessive peaking and overshoot (Note: Capacitive feedback causes the same problems due to the feedback impedance decrease at higher frequencies). At higher gains the amplifier is more stable, so  $R_F$  can be decreased in a trade-off of stability for bandwidth. The table below lists recommended  $R_F$  values for various gains, and the expected bandwidth.

OPTIMUM FEEDBACK RESISTOR

$A_{CL}$	$R_F$ ( $\Omega$ ) SOIC/SOT-23	BANDWIDTH (MHz) SOIC/SOT-23
-1	422/464	650/540
+1	383, (+ $R_S = 226$ )/ 549, (+ $R_S = 100$ )	600/500
+2	576/499	700/540
+5	348/422	480/400
+10	178/348	380/300

### 5V Single Supply Operation

This amplifier operates at single supply voltages down to 4.5V. The dramatic supply current reduction at this operating condition (refer also to Figure 25) makes this op amp an even better choice for low power 5V systems. Refer to Application Note AN9891 for further information.

### Driving Capacitive Loads

Capacitive loads, such as an A/D input, or an improperly terminated transmission line will degrade the amplifier's phase margin resulting in frequency response peaking and possible oscillations. In most cases, the oscillation can be avoided by placing a resistor ( $R_S$ ) in series with the output prior to the capacitance.

Figure 1 details starting points for the selection of this resistor. The points on the curve indicate the  $R_S$  and  $C_L$  combinations for the optimum bandwidth, stability, and settling time, but experimental fine tuning is recommended. Picking a point above or to the right of the curve yields an overdamped response, while points below or left of the curve indicate areas of underdamped performance.

$R_S$  and  $C_L$  form a low pass network at the output, thus limiting system bandwidth well below the amplifier bandwidth of 700MHz/540MHz (SOIC/SOT-23,  $A_V = +2$ ). By decreasing  $R_S$  as  $C_L$  increases (as illustrated by the curves), the maximum bandwidth is obtained without sacrificing stability. In spite of this, bandwidth still decreases as the load capacitance increases. For example, at  $A_V = +2$ ,  $R_S = 20\Omega$ ,  $C_L = 22\text{pF}$ , the SOIC bandwidth is 410MHz, but the bandwidth drops to 110MHz at  $A_V = +2$ ,  $R_S = 5\Omega$ ,  $C_L = 390\text{pF}$ .

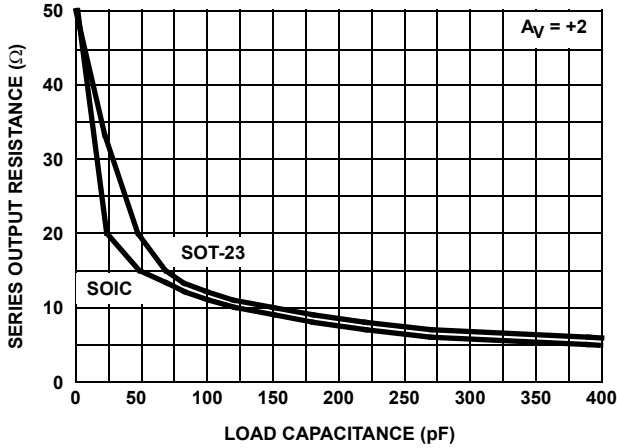

FIGURE 1. RECOMMENDED SERIES OUTPUT RESISTOR vs LOAD CAPACITANCE

**PC Board Layout**

The frequency response of this amplifier depends greatly on the amount of care taken in designing the PC board. **The use of low inductance components such as chip resistors and chip capacitors is strongly recommended, while a solid ground plane is a must!**

Attention should be given to decoupling the power supplies. A large value (10μF) tantalum in parallel with a small value chip (0.1μF) capacitor works well in most cases.

Terminated microstrip signal lines are recommended at the input and output of the device. Output capacitance, such as that resulting from an improperly terminated transmission line, will degrade the frequency response of the amplifier and may cause oscillations. In most cases, the oscillation can be avoided by placing a resistor in series with the output.

Care must also be taken to minimize the capacitance to ground seen by the amplifier's inverting input. The larger this capacitance, the worse the gain peaking, resulting in pulse overshoot and eventual instability. To reduce this capacitance, remove the ground plane under traces connected to -IN and keep these traces as short as possible.

Examples of good high frequency layouts are the evaluation boards shown below.

**Evaluation Boards**

The performance of the HFA1150IB (SOIC) may be evaluated using the HFA11XX Evaluation Board and a SOIC to DIP adaptor like the Aries Electronics Part Number 08-350000-10. The SOT-23 version can be evaluated using the OPAMPSOT23EVAL board.

To order evaluation boards (part number HFA11XXEVAL or OPAMPSOT23EVAL), please contact your local sales office.

The schematic and layout of the HFA11XXEVAL and OPAMPSOT23EVAL boards are shown below.

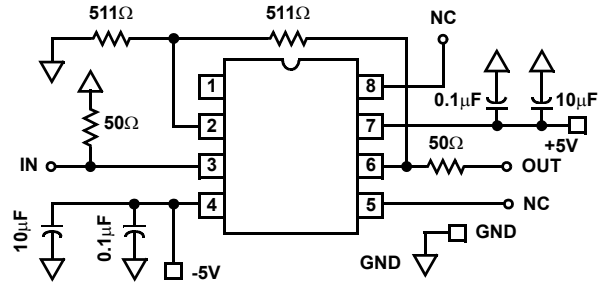
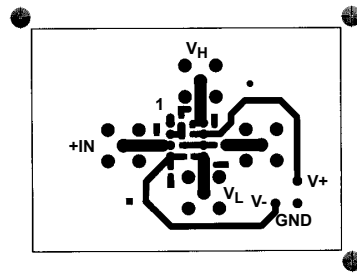
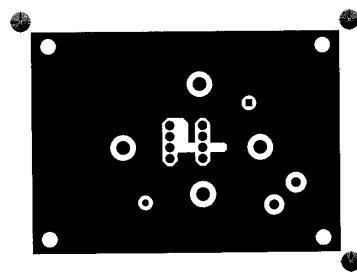

FIGURE 2. HFA11XXEVAL SCHEMATIC

**HFA11XXEVAL TOP LAYOUT**



**HFA11XXEVAL BOTTOM LAYOUT**



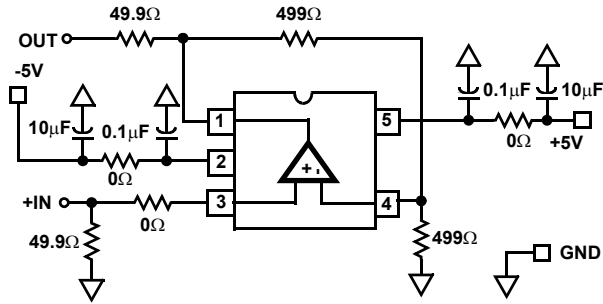
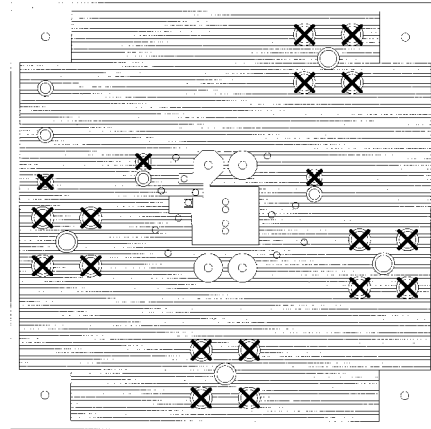
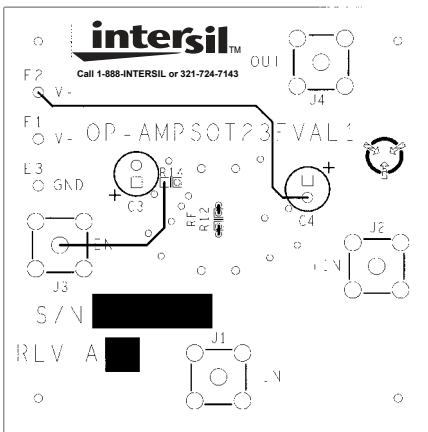

FIGURE 3. OPAMPSOT23EVAL SCHEMATIC



OPAMPSOT23EVAL GND LAYOUT



OPAMPSOT23EVAL TOP LAYOUT

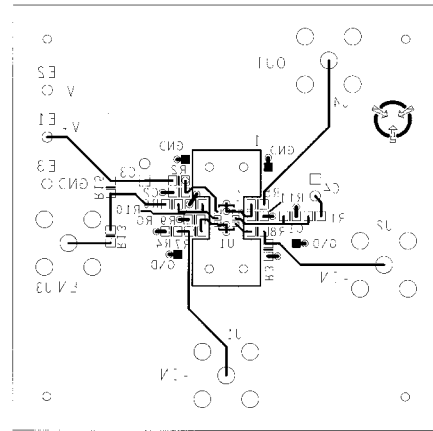

OPAMPSOT23EVAL BOTTOM LAYOUT

**Typical Performance Curves**

$V_{SUPPLY} = \pm 5V$ ,  $R_F =$  Value From the "Optimum Feedback Resistor" Table,  $T_A = 25^\circ C$ ,  
 $R_L = 100\Omega$ , Unless Otherwise Specified

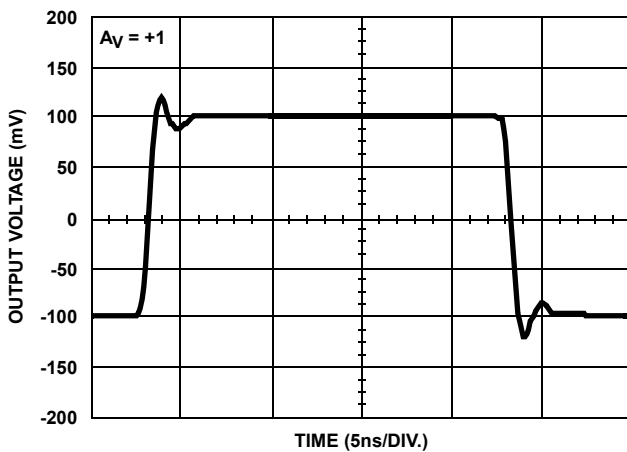

FIGURE 4. SMALL SIGNAL PULSE RESPONSE

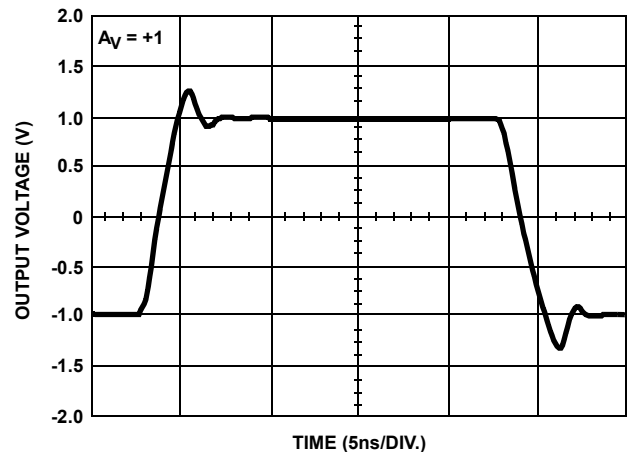

FIGURE 5. LARGE SIGNAL PULSE RESPONSE

**Typical Performance Curves**

$V_{SUPPLY} = \pm 5V$ ,  $R_F =$  Value From the "Optimum Feedback Resistor" Table,  $T_A = 25^\circ C$ ,  
 $R_L = 100\Omega$ , Unless Otherwise Specified (Continued)

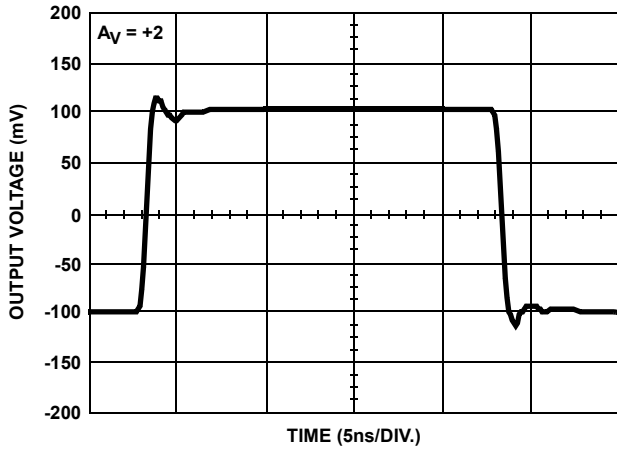

FIGURE 6. SMALL SIGNAL PULSE RESPONSE

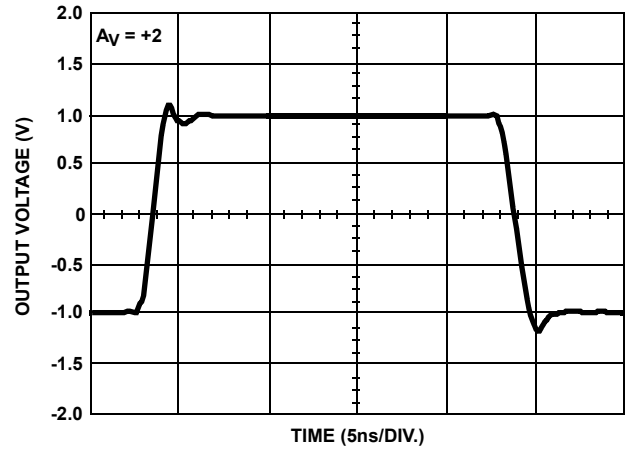

FIGURE 7. LARGE SIGNAL PULSE RESPONSE

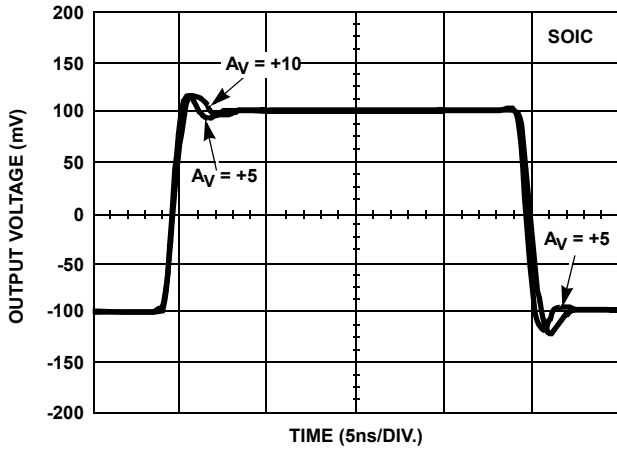

FIGURE 8. SMALL SIGNAL PULSE RESPONSE

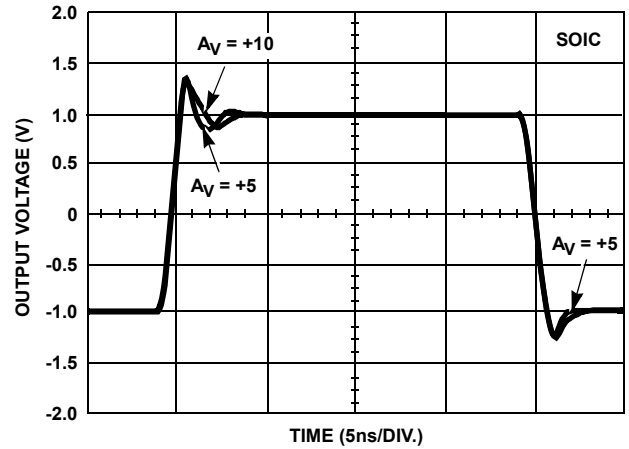

FIGURE 9. LARGE SIGNAL PULSE RESPONSE

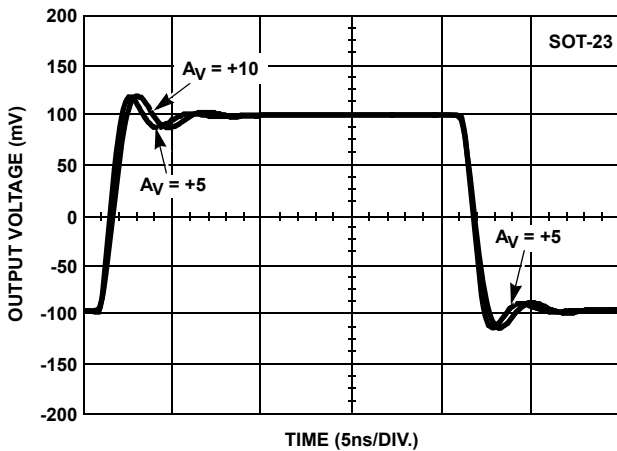

FIGURE 10. SMALL SIGNAL PULSE RESPONSE

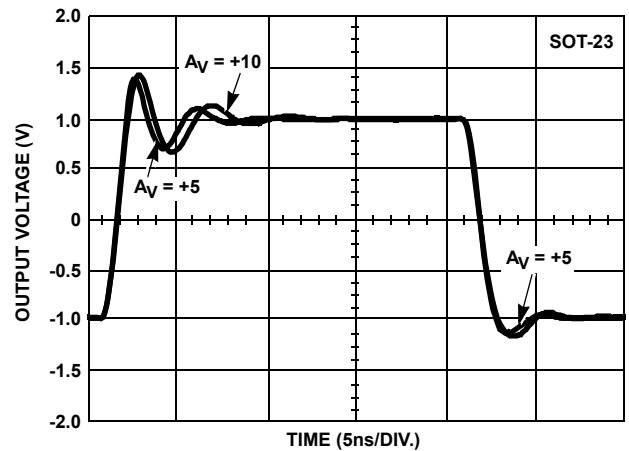

FIGURE 11. LARGE SIGNAL PULSE RESPONSE

**Typical Performance Curves**

$V_{SUPPLY} = \pm 5V$ ,  $R_F =$  Value From the "Optimum Feedback Resistor" Table,  $T_A = 25^\circ C$ ,  
 $R_L = 100\Omega$ , Unless Otherwise Specified (Continued)

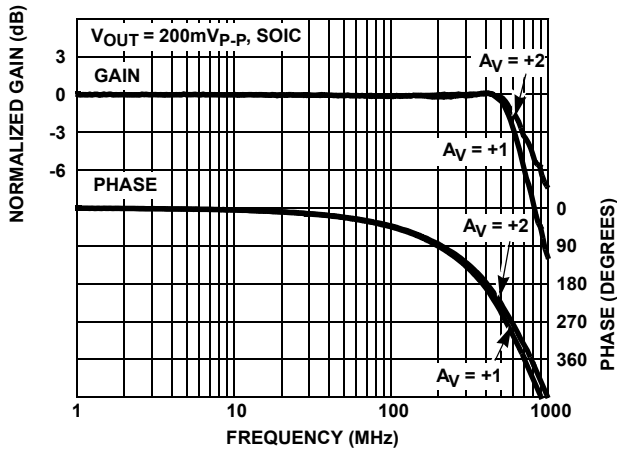

FIGURE 12. FREQUENCY RESPONSE

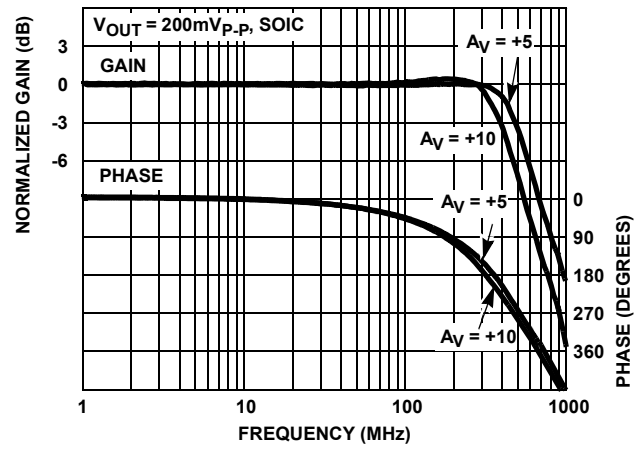

FIGURE 13. FREQUENCY RESPONSE

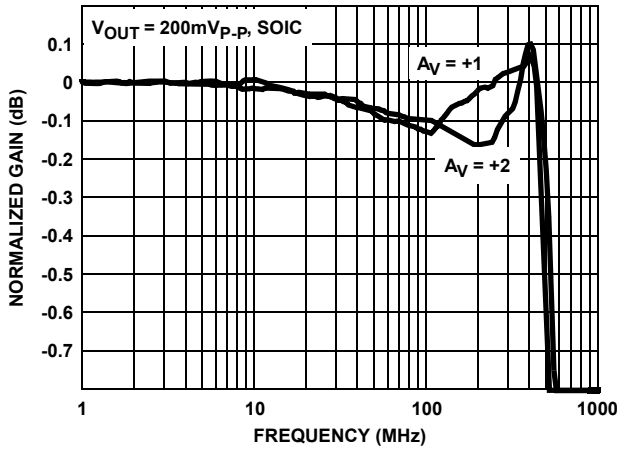

FIGURE 14. GAIN FLATNESS

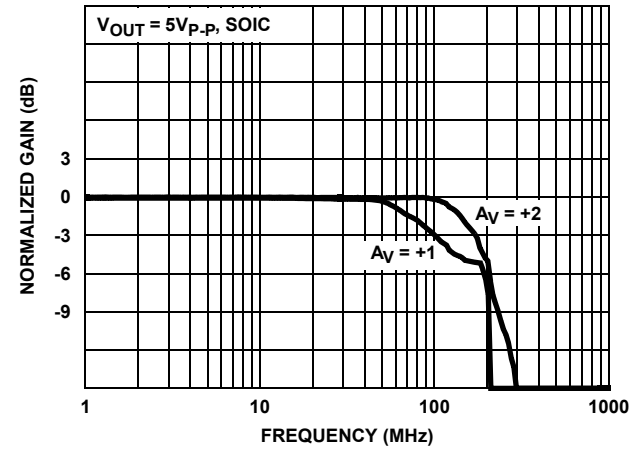

FIGURE 15. FULL POWER BANDWIDTH

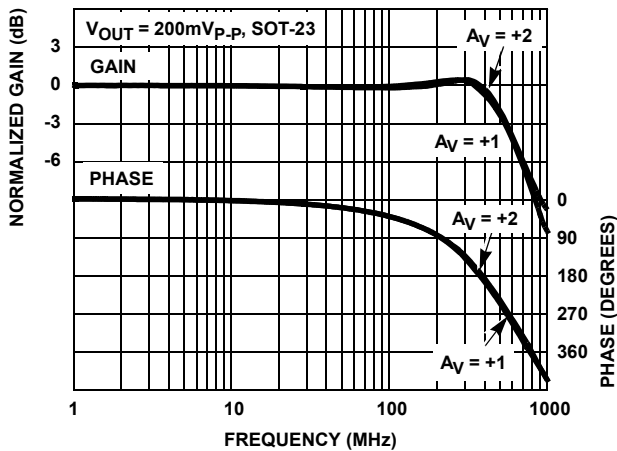

FIGURE 16. FREQUENCY RESPONSE

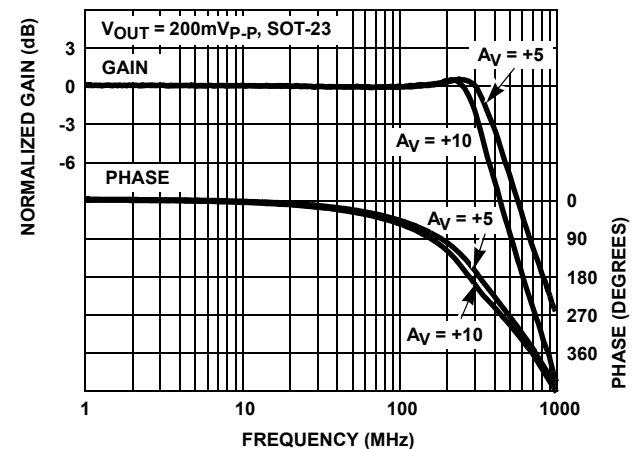

FIGURE 17. FREQUENCY RESPONSE



**Typical Performance Curves**

$V_{SUPPLY} = \pm 5V$ ,  $R_F =$  Value From the "Optimum Feedback Resistor" Table,  $T_A = 25^\circ C$ ,  
 $R_L = 100\Omega$ , Unless Otherwise Specified (Continued)

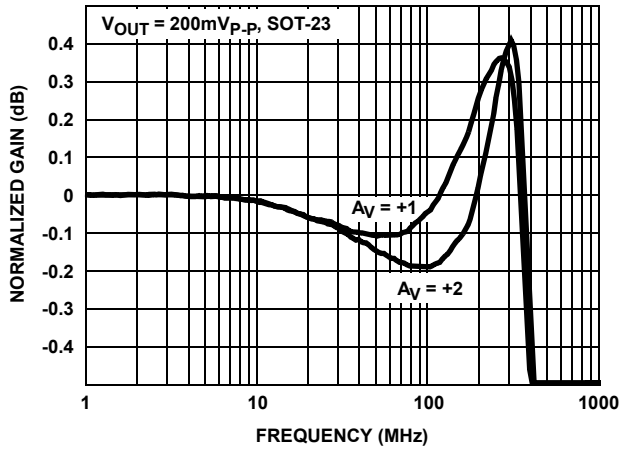

FIGURE 18. GAIN FLATNESS

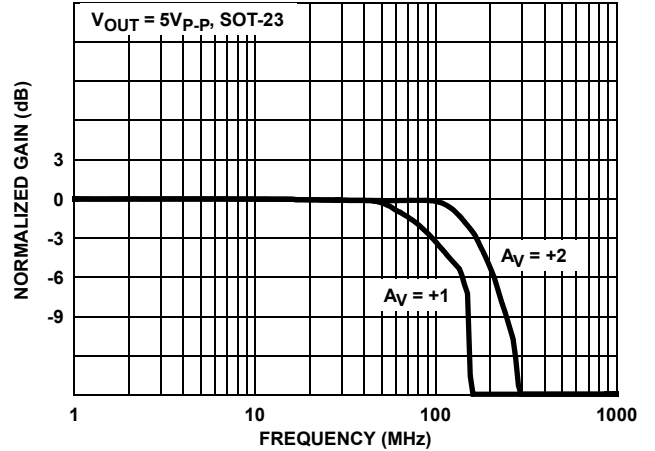

FIGURE 19. FULL POWER BANDWIDTH

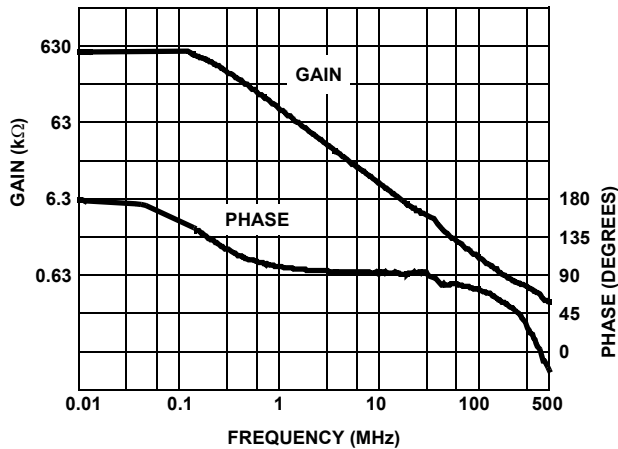

FIGURE 20. OPEN LOOP TRANSIMPEDANCE

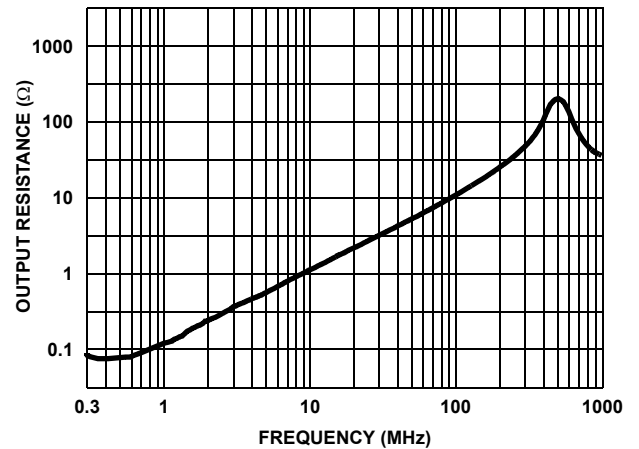

FIGURE 21. CLOSED LOOP OUTPUT RESISTANCE

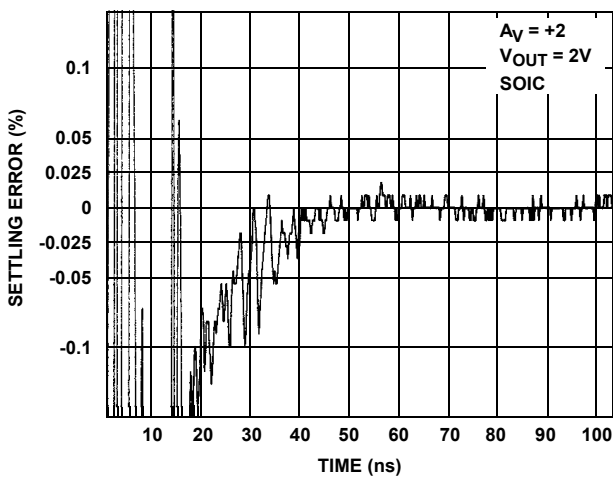

FIGURE 22. SETTLING RESPONSE

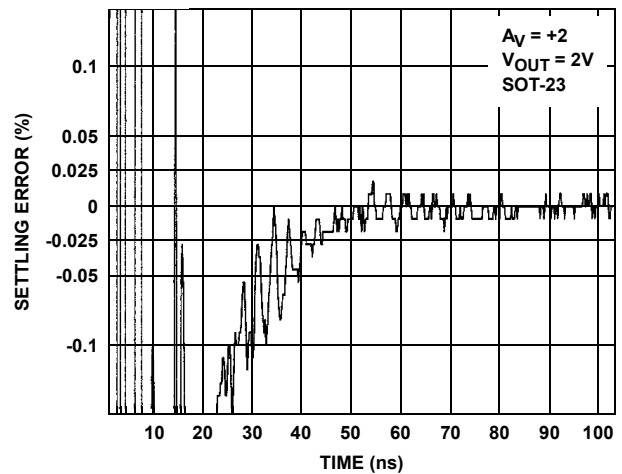

FIGURE 23. SETTLING RESPONSE

**Typical Performance Curves**

$V_{SUPPLY} = \pm 5V$ ,  $R_F =$  Value From the "Optimum Feedback Resistor" Table,  $T_A = 25^\circ C$ ,  
 $R_L = 100\Omega$ , Unless Otherwise Specified (Continued)

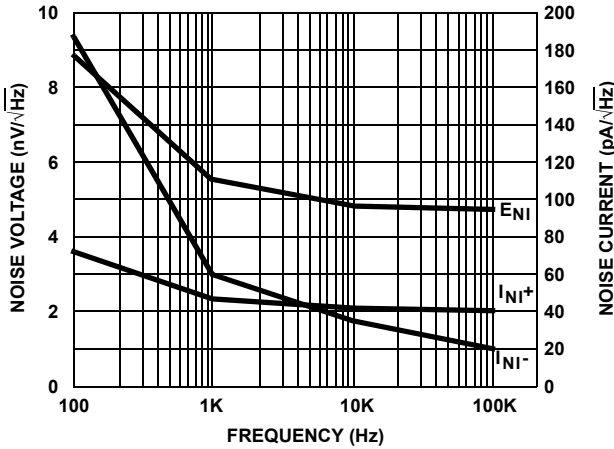

FIGURE 24. INPUT NOISE vs FREQUENCY

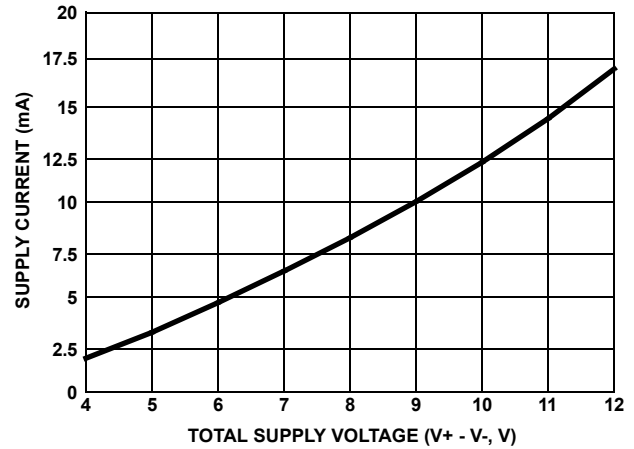

FIGURE 25. SUPPLY CURRENT vs SUPPLY VOLTAGE

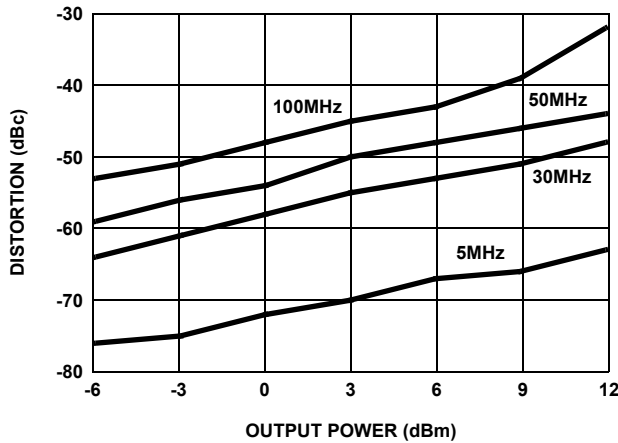

FIGURE 26. 2nd HARMONIC DISTORTION vs  $P_{OUT}$

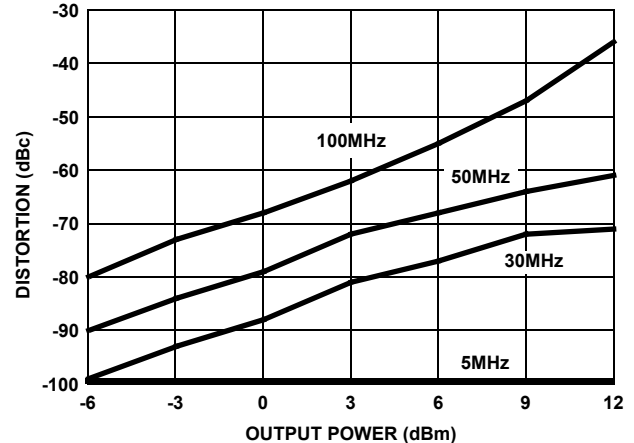

FIGURE 27. 3rd HARMONIC DISTORTION vs  $P_{OUT}$

© Copyright Intersil Americas LLC 2000-2004. All Rights Reserved.  
 All trademarks and registered trademarks are the property of their respective owners.

For additional products, see [www.intersil.com/en/products.html](http://www.intersil.com/en/products.html)

Intersil products are manufactured, assembled and tested utilizing ISO9001 quality systems as noted in the quality certifications found at [www.intersil.com/en/support/qualandreliability.html](http://www.intersil.com/en/support/qualandreliability.html)

*Intersil products are sold by description only. Intersil may modify the circuit design and/or specifications of products at any time without notice, provided that such modification does not, in Intersil's sole judgment, affect the form, fit or function of the product. Accordingly, the reader is cautioned to verify that datasheets are current before placing orders. Information furnished by Intersil is believed to be accurate and reliable. However, no responsibility is assumed by Intersil or its subsidiaries for its use; nor for any infringements of patents or other rights of third parties which may result from its use. No license is granted by implication or otherwise under any patent or patent rights of Intersil or its subsidiaries.*

For information regarding Intersil Corporation and its products, see [www.intersil.com](http://www.intersil.com)

## Die Characteristics

### DIE DIMENSIONS:

53 mils x 25mils  
1350 $\mu$ m x 630 $\mu$ m

### METALLIZATION:

Type: Metal 1: AlCu (2%)/TiW  
Thickness: Metal 1: 8k $\text{\AA}$   $\pm$ 0.4k $\text{\AA}$   
Type: Metal 2: AlCu (2%)  
Thickness: Metal 2: 16k $\text{\AA}$   $\pm$ 0.8k $\text{\AA}$

### PASSIVATION:

Type: Nitride  
Thickness: 4k $\text{\AA}$   $\pm$ 0.5k $\text{\AA}$

### TRANSISTOR COUNT:

40

### SUBSTRATE POTENTIAL (POWERED UP):

Floating (Recommend Connection to V-)

## Metallization Mask Layout

