



DCM™ DC-DC Converter

DCM2322xA5N17A2y6z



Isolated, Regulated DC Converter

Features & Benefits

- Isolated, regulated DC-DC converter
- Up to 120W, 8.00A continuous
- 90.8% peak efficiency
- 481W/in³ power density
- Wide input range 43 – 154V_{DC}
- Safety Extra Low Voltage (SELV) 15.0V nominal output
- 3000V_{DC} isolation
- ZVS high-frequency switching
 - Enables low-profile, high-density filtering
- Dual modes of operation:
 - Array mode
 - Up to 8 units – 960W
 - No power de-rating needed
 - Sharing strategy permits dissimilar line voltages across an array
 - Enhanced V_{OUT} regulation mode
 - Standalone 120W
- Fully operational current limit
- OV, OC, UV, short circuit and thermal shut down

Typical Applications

- Rail Transportation
- Defense / Aerospace
- Industrial
- Process Control

Product Ratings	
V _{IN} = 43 – 154V	P _{OUT} = 120W
V _{OUT} = 15.0V (9.0 – 16.5V Trim)	I _{OUT} = 8.00A

Product Description

The DCM2322 is a lower-power, isolated and regulated DC-DC converter that operates from an unregulated, wide-range input to generate an isolated 15.0V_{DC} output. With its high-frequency zero-voltage switching (ZVS) topology, the DCM2322 converter consistently delivers high efficiency across the input line range. Modular DCM converters and downstream DC-DC products support efficient power distribution, providing superior power system performance and connectivity from a variety of unregulated power sources to the point-of-load.

Leveraging the thermal and density benefits of Vicor ChiP packaging technology, the DCM2322 offers flexible thermal management options with very low top- and bottom-side thermal impedances. Thermally-adept ChiP-based power components enable customers to quickly and predictably achieve cost-effective power-system solutions.

Package Information

- Through-hole ChiP™ package
 - 0.978 x 0.898 x 0.284in
[24.84 x 22.80 x 7.21mm]
 - Weight: 14.4g
[0.51oz]

Note: Product images may not highlight current product markings and cosmetic features.

Typical Applications

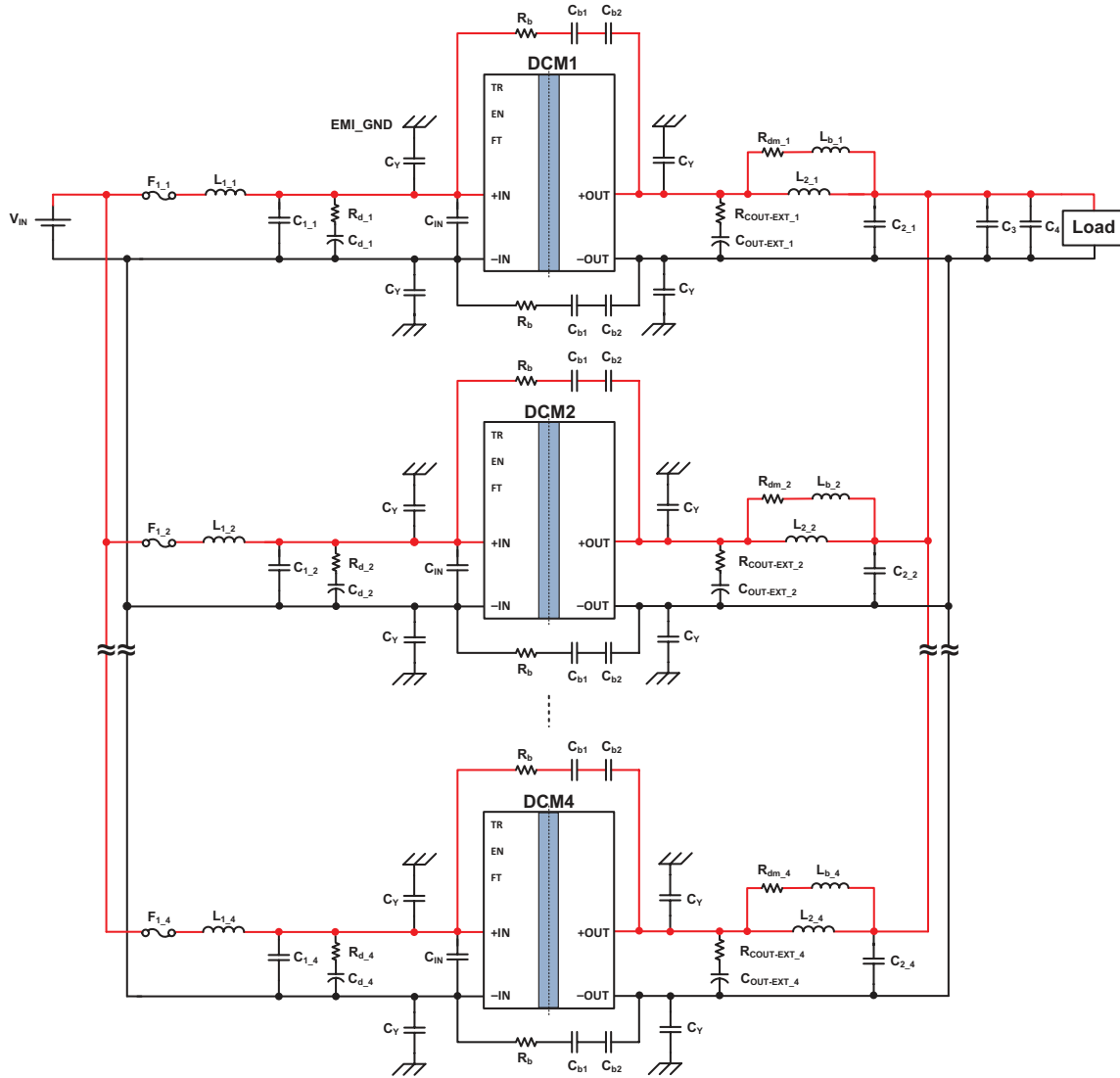

Note: C_{IN} , R_b , C_{b1} and C_{b2} are required components for proper operation of the DCM. See required components table below.

DCM2322xA5N17A2y6z in an array of four units; applicable when DCM is operating in Array Mode

Required Components	
C_{IN}	TDK C5750X7T2E225M250KA, 2.2 μ F, 250V
R_b	Generic 1 Ω , 1/4W
C_{b1} , C_{b2}	KEMET C1812C103KGRACU, 10,000pF, 2000V

Typical Applications (Cont.)

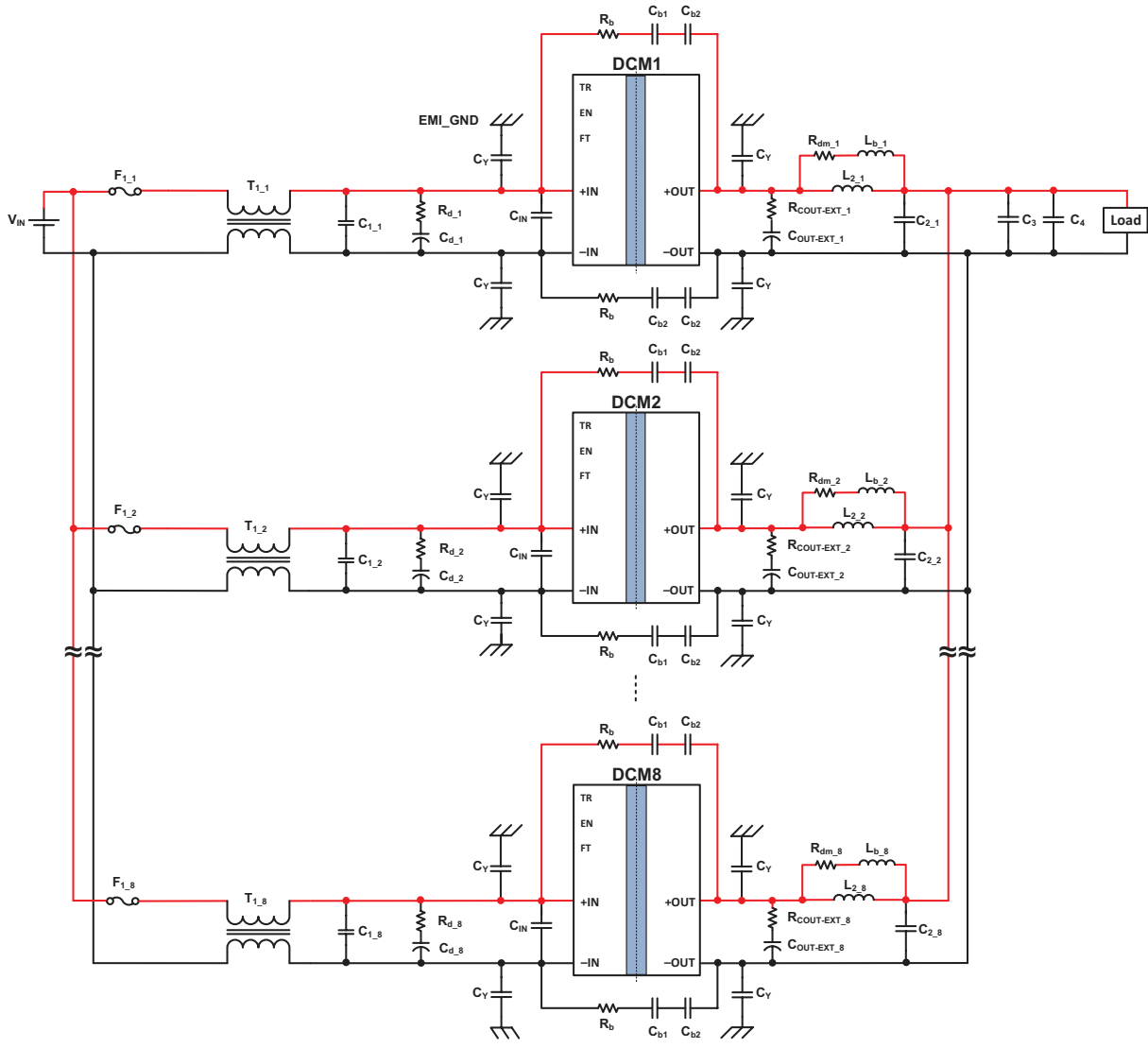

Note: C_{IN} , R_b , C_{b1} and C_{b2} are required components for proper operation of the DCM. See required components table on page 2.

Parallel operation of DCMs with common-mode chokes installed on the input side to suppress common-mode noise; applicable when DCM is operating in Array Mode

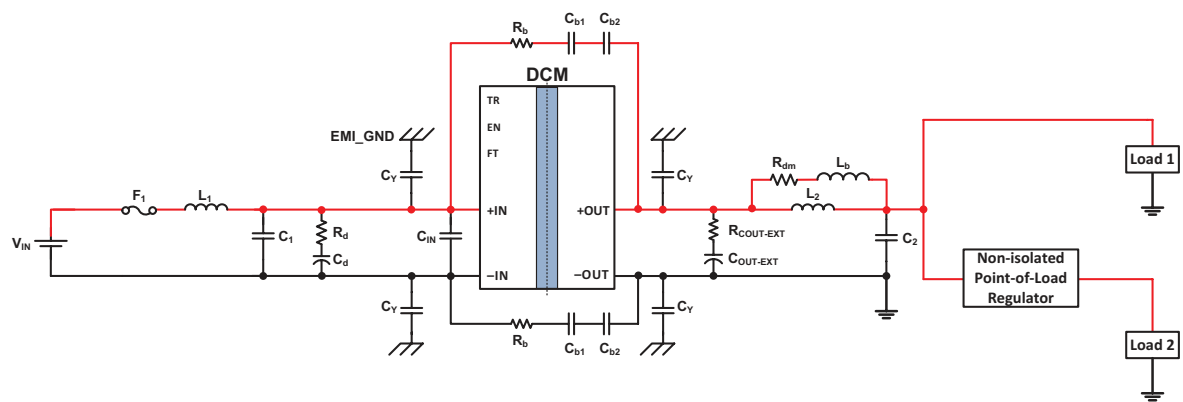

Note: C_{IN} , R_b and C_b are required components for proper operation of the DCM. See required components table on page 2

Single DCM2322xA5N17A2y6z to a non-isolated regulator and direct-to-load

Pin Configuration

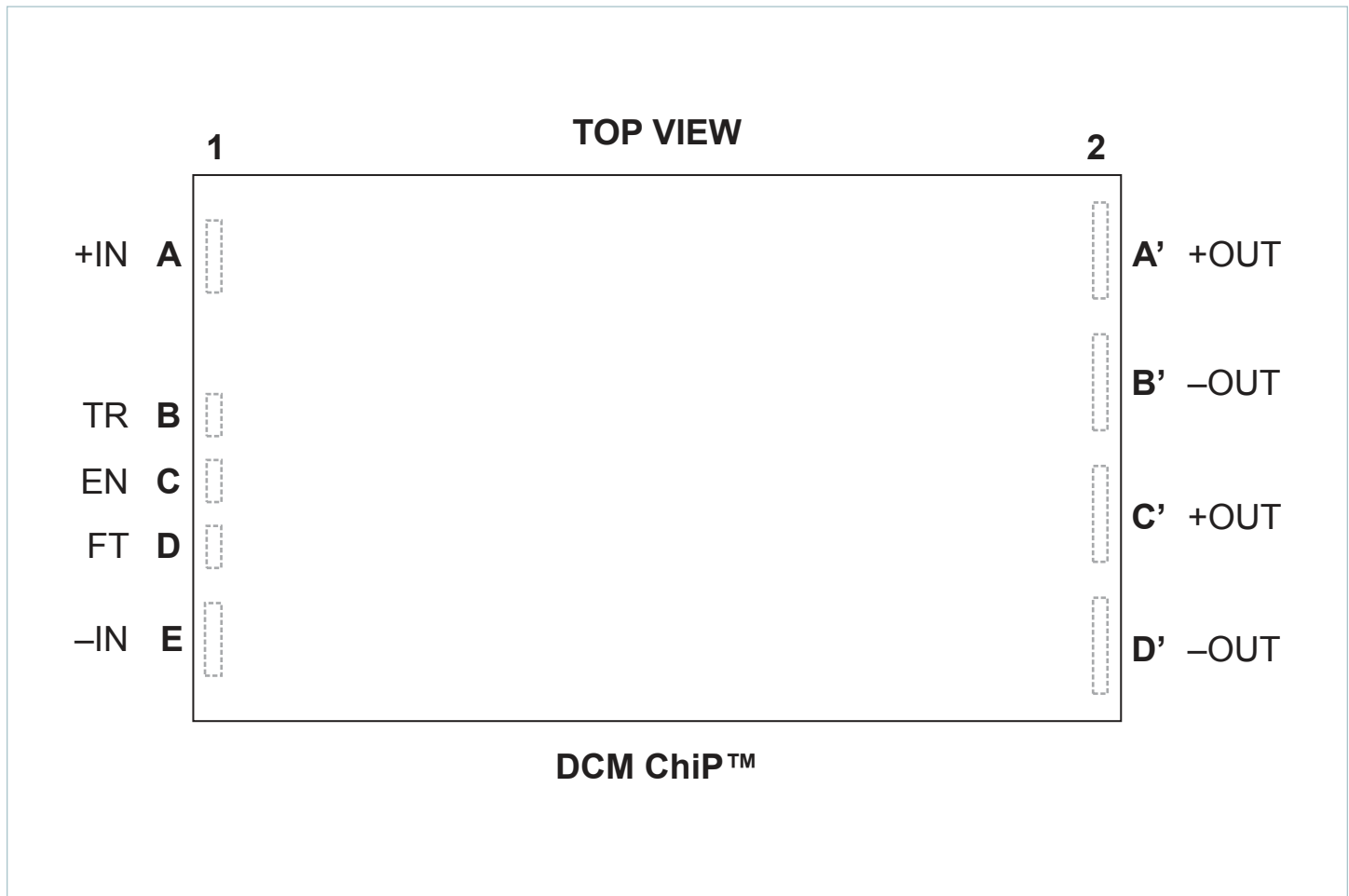

Pin Descriptions

Pin Number	Signal Name	Type	Function
A1	+IN	INPUT POWER	Positive input power terminal
B1	TR	INPUT	Enables and disables trim functionality; adjusts output voltage when trim active
C1	EN	INPUT	Dual function: 1. Enables either Array or Enhanced V_{OUT} Regulation Mode 2. Enables and disables power supply
D1	FT	OUTPUT	Fault monitoring
E1	-IN	INPUT POWER RETURN	Negative input power terminal
A'2, C'2	+OUT	OUTPUT POWER	Positive output power terminal
B'2, D'2	-OUT	OUTPUT POWER RETURN	Negative output power terminal

Part Ordering Information

Part Number	Temperature Grade	Option	Tray Size
DCM2322TA5N17A2 C60	C = -20 to 125°C	60 = Array and Enhanced V_{OUT} Regulation Modes / Analog control Interface Version	24 parts per tray
DCM2322TA5N17A2 T60	T = -40 to 125°C		
DCM2322TA5N17A2 M60	M = -55 to 125°C		

Storage and Handling Information

Note: For compressive loading refer to Application Note [AN:036](#), "Recommendations for Maximum Compressive Force of Heat Sinks."
For handling and assembly processing refer to Application Note [AN:031](#), "Through-Hole ChiP™ Package Soldering Guidelines."

Parameter	Comments	Specification
Storage Temperature Range	C-Grade	-20 to 125°C
	T-Grade	-40 to 125°C
	M-Grade	-65 to 125°C
Operating Internal Temperature Range (T_{INT})	C-Grade	-20 to 125°C
	T-Grade	-40 to 125°C
	M-Grade	-55 to 125°C
Peak Temperature Top Case (Soldering) ^[a]	For further information, please contact factory applications	135°C
Lead Finish	Nickel	0.51 – 2.03µm
	Palladium	0.02 – 0.15µm
	Gold	0.003 – 0.051µm
Weight		14.4g [0.51oz]
MSL Rating	Not applicable to through-hole ChiP products	N/A
ESD Rating	Method per Human Body Model (HBM) Test ESDA / JEDEC JDS-001-2012	Class 1C
	Charged Device Model (CDM) JESD22-C101E	Class 2

^[a] Product is not intended for reflow solder attach.

Safety, Reliability and Agency Approvals

Parameter	Comments	Min	Typ	Max	Unit
Dielectric Withstand Test	IN to OUT	3000			V_{DC}
	IN to CASE	1500			V_{DC}
	OUT to CASE	1500			V_{DC}
Insulation Resistance	IN to OUT, IN to CASE, OUT to CASE at 500 V_{DC} , 1 minute	50			MΩ
MTBF	MIL-HDBK-217 FN2 Parts Count 25°C Ground Benign, Stationary, Indoors / Computer		3.84		MHrs
	Telcordia Issue 2, Method I Case 3, 25°C, 100% D.C., GB, GC		8.95		
Agency Approvals/Standards	cURus, UL 60950-1				
	cTÜVus, EN 62368-1				
	UKCA, electrical equipment (safety) regulations				
	CE Marked for Low Voltage Directive and RoHS Recast Directive, as applicable				

Absolute Maximum Ratings

The absolute maximum ratings below are stress ratings only. Operation at or beyond these maximum ratings can cause permanent damage to the device. Electrical specifications do not apply when operating beyond rated operating conditions.

Parameter	Comments	Min	Max	Unit
Input Voltage (+IN to -IN)		-0.5	175.0	V
Input Voltage Slew Rate		-1	1	V/ μ s
TR to -IN		-0.3	3.5	V
EN to -IN		-0.3	3.5	V
FT to -IN		-0.3	3.5	V
			5	mA
Output Voltage (+OUT to -OUT)		-0.5	19.8	V
Dielectric Withstand (Input to Output)	Supplementary insulation	3000		V _{DC}
Average Output Current			14.0	A

Common Electrical Specifications for Array and Enhanced V_{OUT} Regulation Operation

Specifications apply over all line, trim and load conditions, internal temperature $T_{INT} = 25^{\circ}\text{C}$, unless otherwise noted. **Boldface** specifications apply over the temperature range of $-20^{\circ}\text{C} < T_{INT} < 125^{\circ}\text{C}$ for C-Grade, $-40^{\circ}\text{C} < T_{INT} < 125^{\circ}\text{C}$ for T-Grade and $-55^{\circ}\text{C} < T_{INT} < 125^{\circ}\text{C}$ for M-Grade.

Attribute	Symbol	Conditions / Notes	Min	Typ	Max	Unit
Power Input Specifications						
Input Voltage Range	V_{IN}	Continuous operation	43	100	154	V
Inrush Current (Peak)	I_{INRP}	With maximum $C_{OUT-EXT}$, full resistive load			6.0	A
Input Capacitance (Internal)	C_{IN-INT}	Effective value at nominal input voltage		1.3		μF
Input Capacitance (Internal) ESR	$R_{CIN-INT}$	At 1MHz		2.68		m Ω
Input Inductance (External)	L_{IN}	Differential mode, with no further line bypassing			1	μH
No-Load Specifications						
Input Power – Disabled	P_Q	Nominal line, see Figure 4; C-Grade		0.7	1.0	W
		Worst case line, see Figure 4; C-Grade			1.2	
		Nominal line, see Figure 4; T- and M-Grades		0.6	0.8	
		Worst case line, see Figure 4; T- and M-Grades			1.0	
Input Power – Enabled with No Load	P_{NL}	Nominal line, see Figure 5; C-Grade		2.4	4.2	W
		Worst case line, see Figure 5; C-Grade			4.2	
		Nominal line, see Figure 5; T- and M-Grades		2.0	3.5	
		Worst case line, see Figure 5; T- and M-Grades			3.5	
Power Output Specifications						
Output Voltage Set Point	$V_{OUT-NOM}$	$V_{IN} = 100\text{V}$, nominal trim, at 100% load, $T_{INT} = 25^{\circ}\text{C}$	14.93	15.0	15.08	V
Rated Output Voltage Trim Range	$V_{OUT-TRIMMING}$	Specifies the low, nominal and high trim conditions <ul style="list-style-type: none"> • Array Mode: trim range over temp at full load • Enhanced V_{OUT} Regulation Mode: trim range over temp, with >10% rated load 	9.0	15.0	16.5	V
Rated Output Power	P_{OUT}	Continuous, $V_{OUT} \geq 15.0\text{V}$	120			W
Rated Output Current	I_{OUT}	Continuous, $V_{OUT} \leq 15.0\text{V}$	8.00			A
Output Current Limit	$I_{OUT-LIM}$	Of rated I_{OUT} max; fully operational current limit, for nominal trim and below	100	120	140	%
Current Limit Delay	$t_{OUT-LIM}$	The module will power limit in a fast transient event		1		ms
Efficiency	η	Full load, nominal line, nominal trim	89.3	90.8		%
		Full load, over line and temperature, nominal trim; C-Grade	78.4			
		50% load, over rated line, temperature and trim; C-Grade	73.5			
		Full load, over line and temperature, nominal trim; T- and M-Grades	80.0			
		50% load, over rated line, temperature and trim; T- and M-Grades	75.0			
Output Voltage Ripple	V_{OUT-PP}	20MHz bandwidth. At nominal trim, minimum $C_{OUT-EXT}$ and at least 10% rated load		358		mV

Common Electrical Specifications for Array and Enhanced V_{OUT} Regulation Operation (Cont.)

Specifications apply over all line, trim and load conditions, internal temperature $T_{INT} = 25^{\circ}\text{C}$, unless otherwise noted. **Boldface** specifications apply over the temperature range of $-20^{\circ}\text{C} < T_{INT} < 125^{\circ}\text{C}$ for C-Grade, $-40^{\circ}\text{C} < T_{INT} < 125^{\circ}\text{C}$ for T-Grade and $-55^{\circ}\text{C} < T_{INT} < 125^{\circ}\text{C}$ for M-Grade.

Attribute	Symbol	Conditions / Notes	Min	Typ	Max	Unit
Power Output Specifications (Cont.)						
Output Capacitance (Internal)	$C_{OUT-INT}$	Effective value at nominal output voltage		170		μF
Output Capacitance (Internal) ESR	$R_{COUT-INT}$	At 1MHz		0.171		$\text{m}\Omega$
Output Capacitance (External)	$C_{OUT-EXT}$	Excludes component temperature coefficient for load transients that remain $>10\%$ rated load	470		10000	μF
	$C_{OUT-EXT-TRANS}$	Excludes component temperature coefficient for load transients down to I_{TRAN_MIN} rated load, with static trim	4700		10000	
	$C_{OUT-EXT-TRANS-TRIM}$	Excludes component temperature coefficient for load transients down to I_{TRAN_MIN} rated load, with dynamic trimming	8200		10000	
Minimum Transient Load	I_{TRAN_MIN}	Minimum required load for proper operation of DCM during load transient conditions	0			%
Output Capacitance ESR (External)	$R_{COUT-EXT}$	At 10kHz, excludes component tolerances	10			$\text{m}\Omega$
Initialization Delay	t_{INIT}	See state diagram		25	40	ms
Output Turn-On Delay	t_{ON}	From rising edge EN, with V_{IN} pre-applied; see timing diagram		200		μs
Output Turn-Off Delay	t_{OFF}	From falling edge EN; see timing diagram			600	μs
Soft Start Ramp Time	t_{SS}	At full rated resistive load; Typical spec is 1-up with minimum $C_{OUT-EXT}$; Max spec is for arrays with max $C_{OUT-EXT}$		150	300	ms
Output Voltage Threshold for Max Rated Load Current	$V_{OUT-FL-THRESH}$	During start up, V_{OUT} must achieve this threshold before output can support full rated current			7.5	V
Output Current at Start Up	$I_{OUT-START}$	Max load current at start up while V_{OUT} is below V_{OUT-FL_THRESH}	0.80			A
Monotonic Soft-Start Threshold Voltage	$V_{OUT-MONOTONIC}$	Output voltage rise becomes monotonic with 10% of preload once it crosses $V_{OUT-MONOTONIC}$			7.5	V
Minimum Required Disabled Duration	$t_{OFF-MIN}$	This refers to the minimum time a module needs to be in the disabled state before it will attempt to start via EN			2	ms
Minimum Required Disabled Duration for Predictable Restart	$t_{OFF-MONOTONIC}$	This refers to the minimum time a module needs to be in the disabled state before it is guaranteed to exhibit monotonic soft-start and have predictable start-up timing			100	ms
Voltage Deviation (Transient)	$\%V_{OUT-TRANS}$	Minimum C_{OUT_EXT} (10 \leftrightarrow 90% load step), excluding load line		<10		%
Settling Time	t_{SETTLE}			8.0		ms

Common Electrical Specifications for Array and Enhanced V_{OUT} Regulation Operation (Cont.)

Specifications apply over all line, trim and load conditions, internal temperature $T_{INT} = 25^{\circ}\text{C}$, unless otherwise noted. **Boldface** specifications apply over the temperature range of $-20^{\circ}\text{C} < T_{INT} < 125^{\circ}\text{C}$ for C-Grade, $-40^{\circ}\text{C} < T_{INT} < 125^{\circ}\text{C}$ for T-Grade and $-55^{\circ}\text{C} < T_{INT} < 125^{\circ}\text{C}$ for M-Grade.

Attribute	Symbol	Conditions / Notes	Min	Typ	Max	Unit
Powertrain Protections						
Input Voltage Initialization Threshold	$V_{IN-INIT}$	Threshold to start t_{INIT} delay			9	V
Input Voltage Reset Threshold	$V_{IN-RESET}$	Latching faults will clear once V_{IN} falls below $V_{IN-RESET}$	3			V
Input Undervoltage Lockout Threshold	$V_{IN-UVLO-}$		25.80		40.85	V
Input Undervoltage Recovery Threshold	$V_{IN-UVLO+}$	See timing diagram			43.00	V
Input Overvoltage Lockout Threshold	$V_{IN-OVLO+}$				171	V
Input Overvoltage Recovery Threshold	$V_{IN-OVLO-}$	See timing diagram	154			V
Output Overvoltage Threshold	$V_{OUT-OVP}$	From 25 to 100% load; latched shut down	18.98			V
	$V_{OUT-OVP-LL}$	From 0 to 25% load; latched shut down	19.80			V
Minimum Current-Limited Output Voltage	$V_{OUT-LVP}$	Over all operating steady-state line and trim conditions			6.75	V
Overtemperature Threshold (Internal)	$T_{INT-OTP}$		125			$^{\circ}\text{C}$
Power Limit	P_{LIM}				180	W
Input Voltage Overvoltage to Cessation of Powertrain Switching	$t_{OVLO-SW}$	Independent of fault logic		2.8		μs
Input Voltage Overvoltage Response Time	t_{OVLO}	For fault logic only			200	μs
Input Voltage Undervoltage Response Time	t_{UVLO}				100	ms
Short Circuit Response Time	t_{SC}	Powertrain on, operational state			200	μs
Short Circuit, or Temperature Fault Recovery Time	t_{FAULT}	See timing diagram		1		s

Common Electrical Specifications for Array and Enhanced V_{OUT} Regulation Operation (Cont.)

Specifications apply over all line, trim and load conditions, internal temperature $T_{INT} = 25^{\circ}\text{C}$, unless otherwise noted. **Boldface** specifications apply over the temperature range of $-20^{\circ}\text{C} < T_{INT} < 125^{\circ}\text{C}$ for C-Grade, $-40^{\circ}\text{C} < T_{INT} < 125^{\circ}\text{C}$ for T-Grade and $-55^{\circ}\text{C} < T_{INT} < 125^{\circ}\text{C}$ for M-Grade.

Attribute	Symbol	Conditions / Notes	Min	Typ	Max	Unit
Trim: TR						
TR Trim Disable Threshold	$V_{TRIM-DIS-TH}$	Trim disabled when TR above this threshold at power up			3.20	V
TR Trim Enable Threshold	$V_{TRIM-EN-TH}$	Trim enabled when TR below this threshold at power up	3.15			V
Internally Generated V_{CC}	V_{CC}		3.21	3.30	3.39	V
TR Pin Functional Range	$V_{TRIM-EN}$		0.00	2.44	3.16	V
V_{OUT} Referred TR Pin Resolution	$V_{OUT-RES}$	With $V_{CC} = 3.3\text{V}$		19		mV
TR Internal Pull-Up Resistance to V_{CC}	$R_{TRIM-INT}$		9.9	10.0	10.1	k Ω
Enable: EN						
EN Enable Threshold	$V_{ENABLE-EN-TH}$				2.31	V
EN Disable Threshold	$V_{ENABLE-DIS-TH}$		0.99			V
Internally Generated V_{CC}	V_{CC}		3.21	3.30	3.39	V
EN internal Pull-Up Resistance to V_{CC}	$R_{ENABLE-INT}$		9.9	10.0	10.1	k Ω
Array Mode Enable Threshold	$V_{ARRAY-EN-TH}$		2.97			V
Enhanced V_{OUT} Regulation Mode Enable Threshold	$V_{REG-EN-TH}$				2.63	V
Fault: FT						
FT Internal Pull-Up Resistance to V_{CC}	$R_{FAULT-INT}$		494	499	504	k Ω
FT Voltage	$V_{FAULT-ACTIVE}$	At rated current drive capability	3.0			V
FT Current Drive Capability	$I_{FAULT-ACTIVE}$	Overload beyond the ABSOLUTE MAXIMUM ratings may cause module damage	4			mA
FT Response Time	$t_{FT-ACTIVE}$	Delay from cessation of switching to FT Pin Active			200	μs

Electrical Specifications: Array Operation Only

Specifications apply over all line, trim and load conditions, internal temperature $T_{INT} = 25^{\circ}\text{C}$, unless otherwise noted. **Boldface** specifications apply over the temperature range of $-20^{\circ}\text{C} < T_{INT} < 125^{\circ}\text{C}$ for C-Grade, $-40^{\circ}\text{C} < T_{INT} < 125^{\circ}\text{C}$ for T-Grade and $-55^{\circ}\text{C} < T_{INT} < 125^{\circ}\text{C}$ for M-Grade.

Attribute	Symbol	Conditions / Notes	Min	Typ	Max	Unit
Power Output Specifications						
Output Voltage Load Regulation	$\Delta V_{OUT-LOAD}$	Linear load line. Output voltage increase from full rated load current to no load (does not include light-load regulation). See Figure 6 and Design Guidelines section; C-Grade	0.6715	0.7895	0.9167	V
		Linear load line. Output voltage increase from full rated load current to no load (does not include light-load regulation). See Figure 6 and Design Guidelines section; T- and M-Grades	0.7068	0.7895	0.8730	
Output Voltage Light-Load Regulation	ΔV_{OUT-LL}	0 – 10% load, additional V_{OUT} , relative to calculated load-line point; see Design Guidelines section	-0.23		1.58	V
Output Voltage Temperature Coefficient	$\Delta V_{OUT-TEMP}$	Nominal, linear temperature coefficient, relative to $T_{INT} = 25^{\circ}\text{C}$; see Figure 20 and Design Guidelines Section		-2.00		mV / $^{\circ}\text{C}$
Output Voltage Accuracy	$\%V_{OUT-ACCURACY}$	The total output voltage set-point accuracy from the calculated ideal V_{OUT} based on load, temp and trim. Excludes ΔV_{OUT-LL} ; C-Grade	-3.4		3.4	%
		The total output voltage set-point accuracy from the calculated ideal V_{OUT} based on load, temp and trim. Excludes ΔV_{OUT-LL} ; T- and M-Grades	-3.0		3.0	

Electrical Specifications: Enhanced V_{OUT} Operation Only

Specifications apply over all line, trim and load conditions, internal temperature $T_{INT} = 25^{\circ}\text{C}$, unless otherwise noted. **Boldface** specifications apply over the temperature range of $-20^{\circ}\text{C} < T_{INT} < 125^{\circ}\text{C}$ for C-Grade, $-40^{\circ}\text{C} < T_{INT} < 125^{\circ}\text{C}$ for T-Grade and $-55^{\circ}\text{C} < T_{INT} < 125^{\circ}\text{C}$ for M-Grade.

Attribute	Symbol	Conditions / Notes	Min	Typ	Max	Unit
Power Output Specifications						
Output Voltage Load Regulation	$\Delta V_{OUT-REGULATION}$	C-Grade; at nominal line, nominal trim, full load and ambient temperature	-0.5		0.5	%
		C-Grade; at nominal line, nominal trim and: • Load >20% of full load and ambient temperature • Full load and over temperature	-1.0		1.0	
		C-Grade; all other conditions (does not include light-load regulation)	-1.7		1.7	
		T- and M-Grades; at nominal line, nominal trim, full load and ambient temperature	-0.5		0.5	
		T- and M-Grades; at nominal line, nominal trim and: • Load >20% of full load and ambient temperature • Full load and over temperature	-1.0		1.0	
		T- and M-Grades; all other conditions (does not include light-load regulation)	-1.5		1.5	
Output Voltage Accuracy	$\%V_{OUT-ACCURACY}$	The total output voltage set-point accuracy from the calculated V_{OUT} based on load, temp and trim; C-Grade; Excludes: • ΔV_{OUT-LL} • $\%V_{OUT-REGULATION}$	-2.3		2.3	%
		The total output voltage set-point accuracy from the calculated V_{OUT} based on load, temp and trim; T- and M-Grades; Excludes: • ΔV_{OUT-LL} • $\%V_{OUT-REGULATION}$	-2.0		2.0	
Output Voltage Light-Load Regulation	ΔV_{OUT-LL}	0 – 10% load, additional V_{OUT} , relative to V_{OUT} accuracy; see Design Guidelines section	-0.23		1.58	V

Specified Operating Area

The absolute maximum ratings below are stress ratings only. Operation at or beyond these maximum ratings can cause permanent damage to the device. Electrical specifications do not apply when operating beyond rated operating conditions.

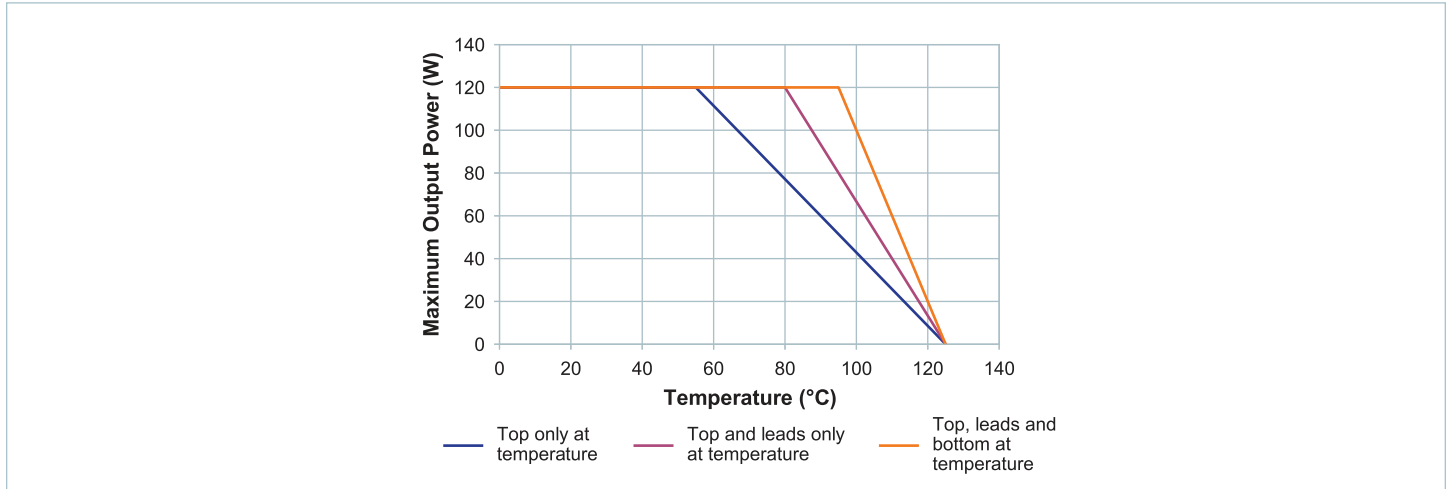

Figure 1 — Thermal specified operating area: max output power vs. case temperature, single unit at minimum full-load efficiency

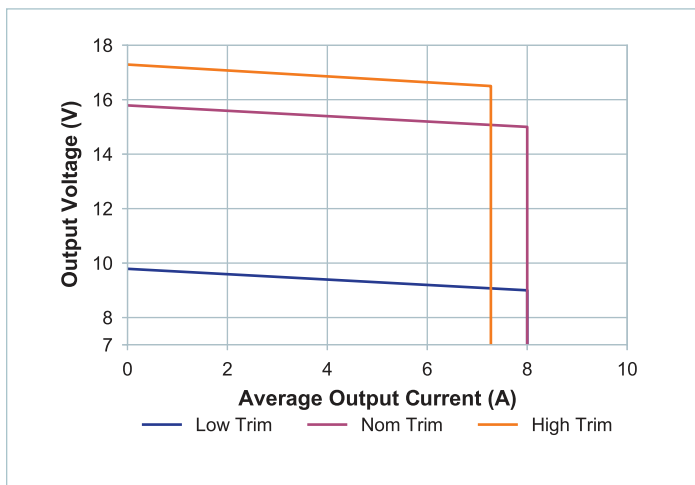

Figure 2 — Electrical specified operating area: Array Mode

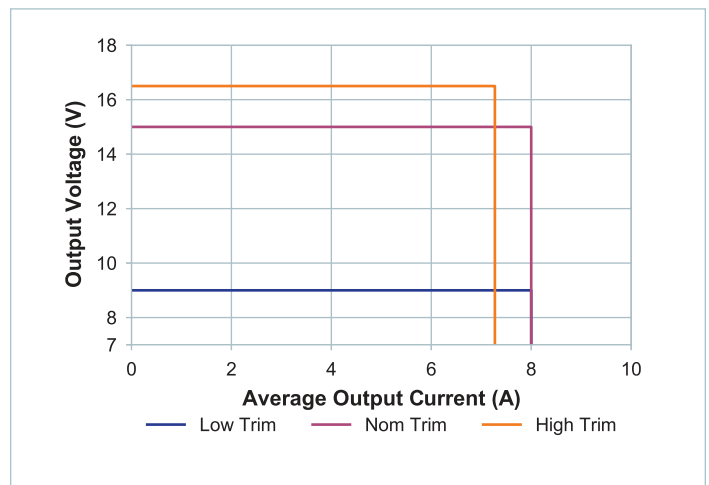
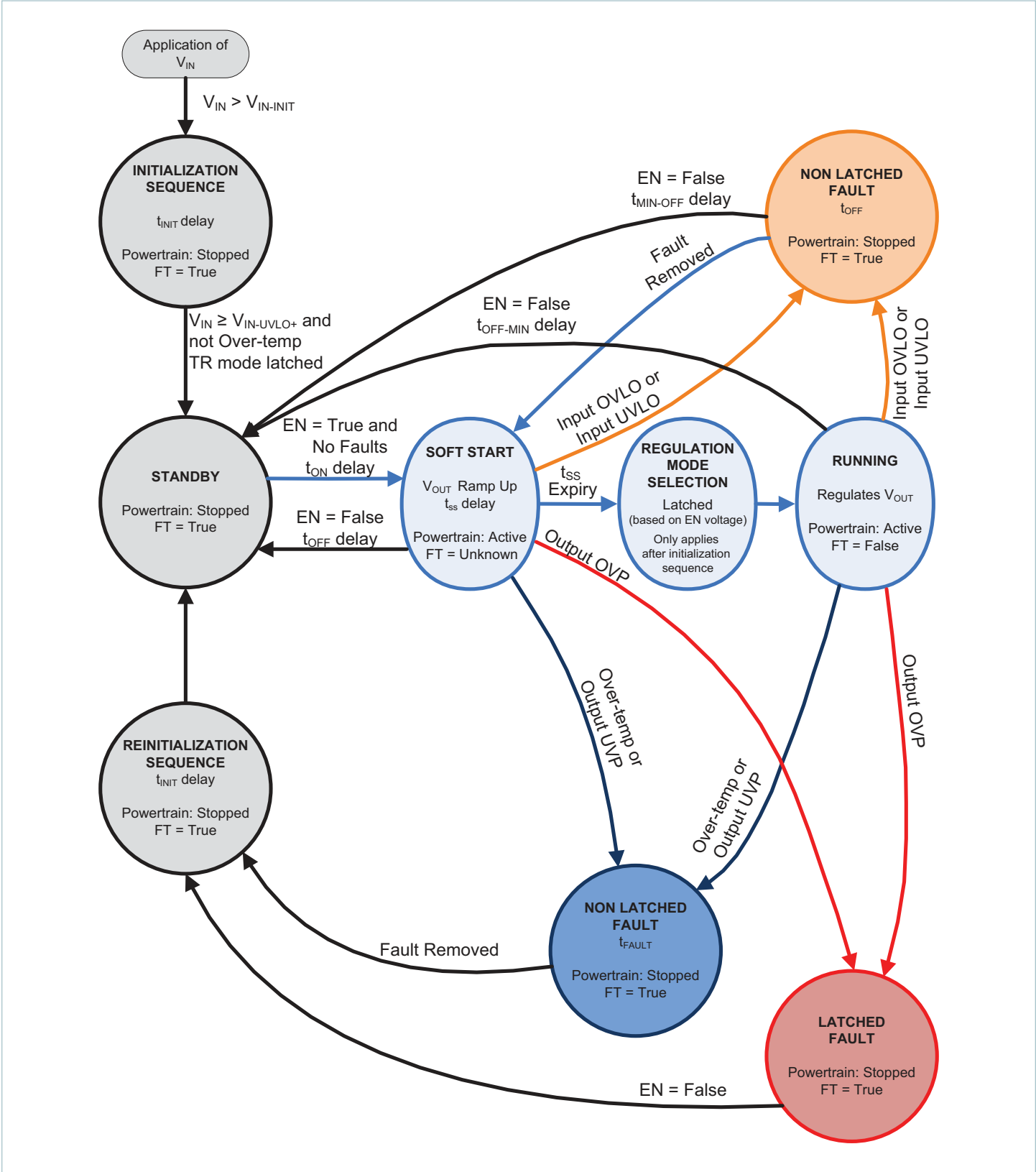

Figure 3 — Electrical specified operating area; Enhanced V_{OUT} Regulation Mode

High-Level Functional State Diagram

Conditions that cause state transitions are shown along arrows. Sub-sequence activities listed inside the state bubbles.



Timing Diagrams – Array Mode

Module inputs are shown in blue; module outputs are shown in brown.

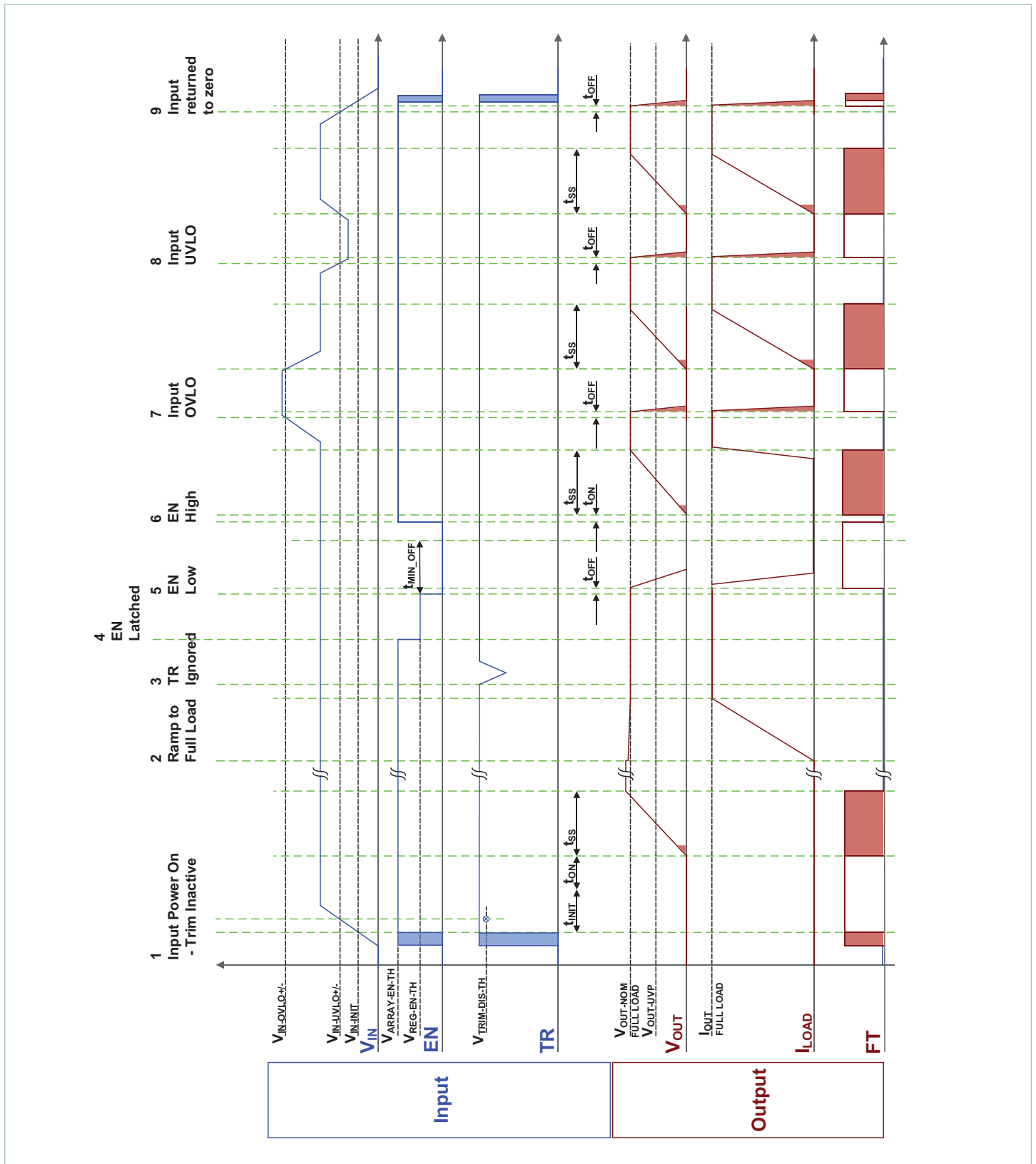

Timing Diagrams – Array Mode (Cont.)

Module inputs are shown in blue; module outputs are shown in brown.

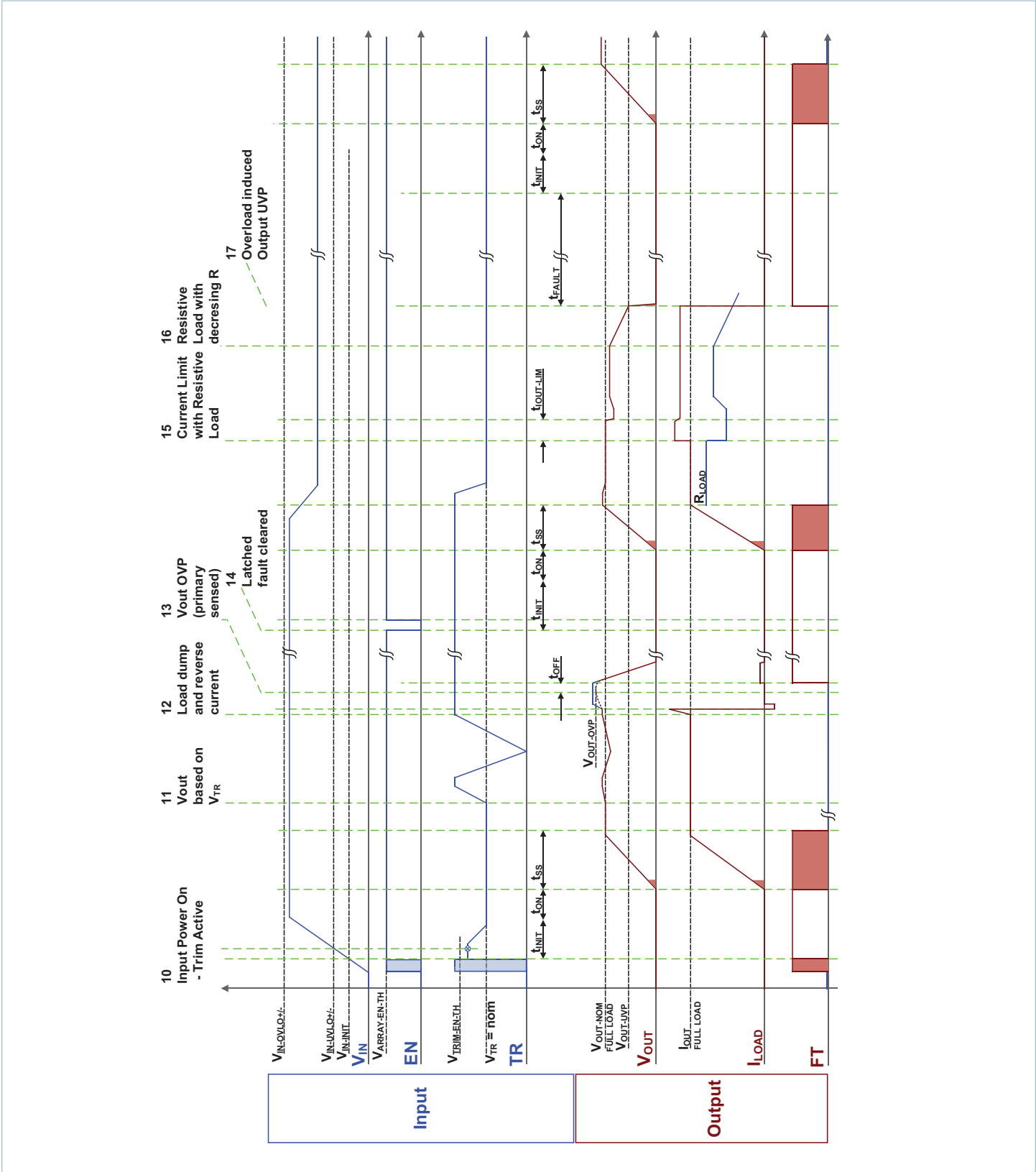

Timing Diagrams – Enhanced V_{OUT} Regulation Mode

Module inputs are shown in blue; module outputs are shown in brown.

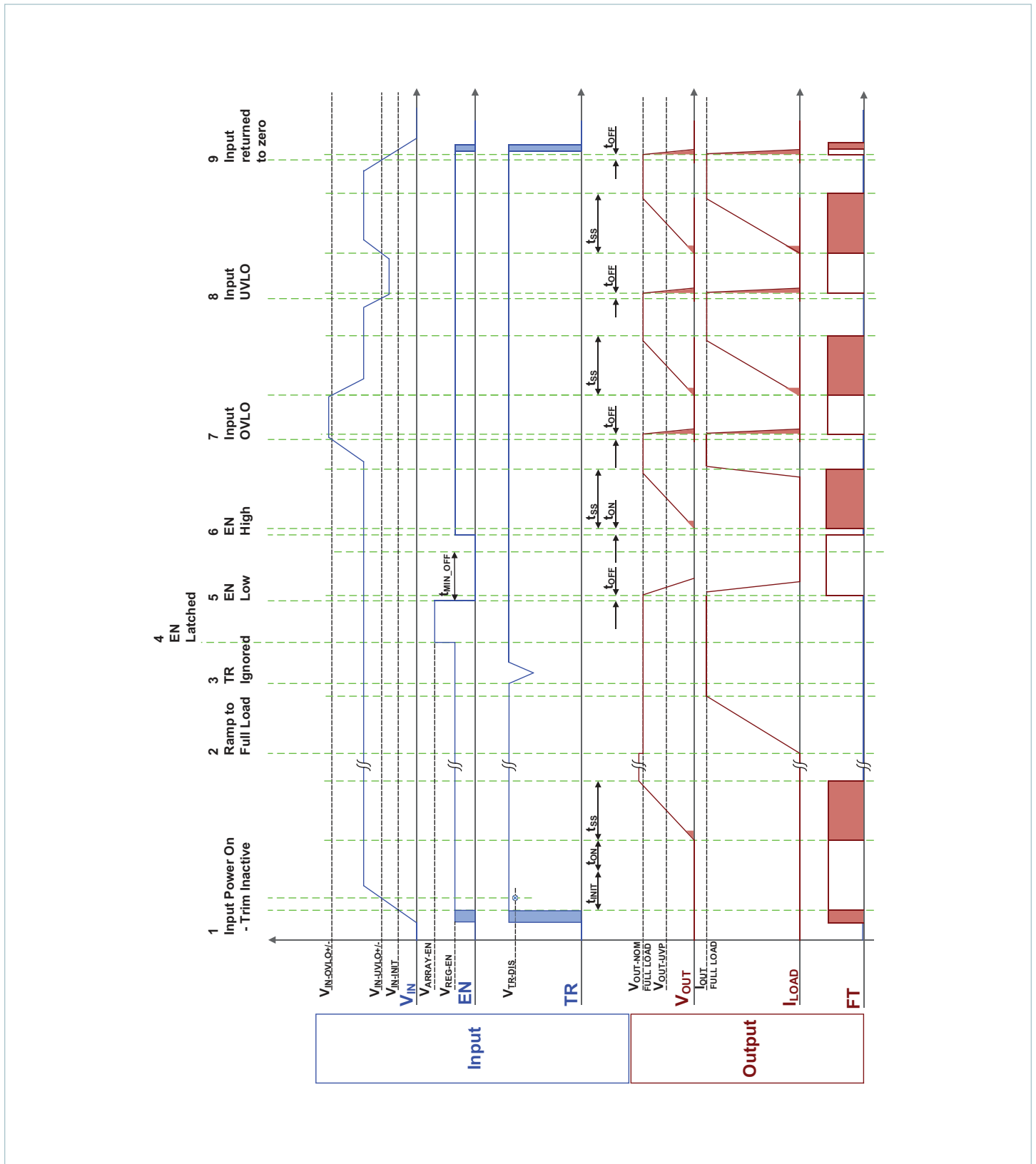

Timing Diagrams – Enhanced V_{OUT} Regulation Mode (Cont.)

Module inputs are shown in blue; module outputs are shown in brown.

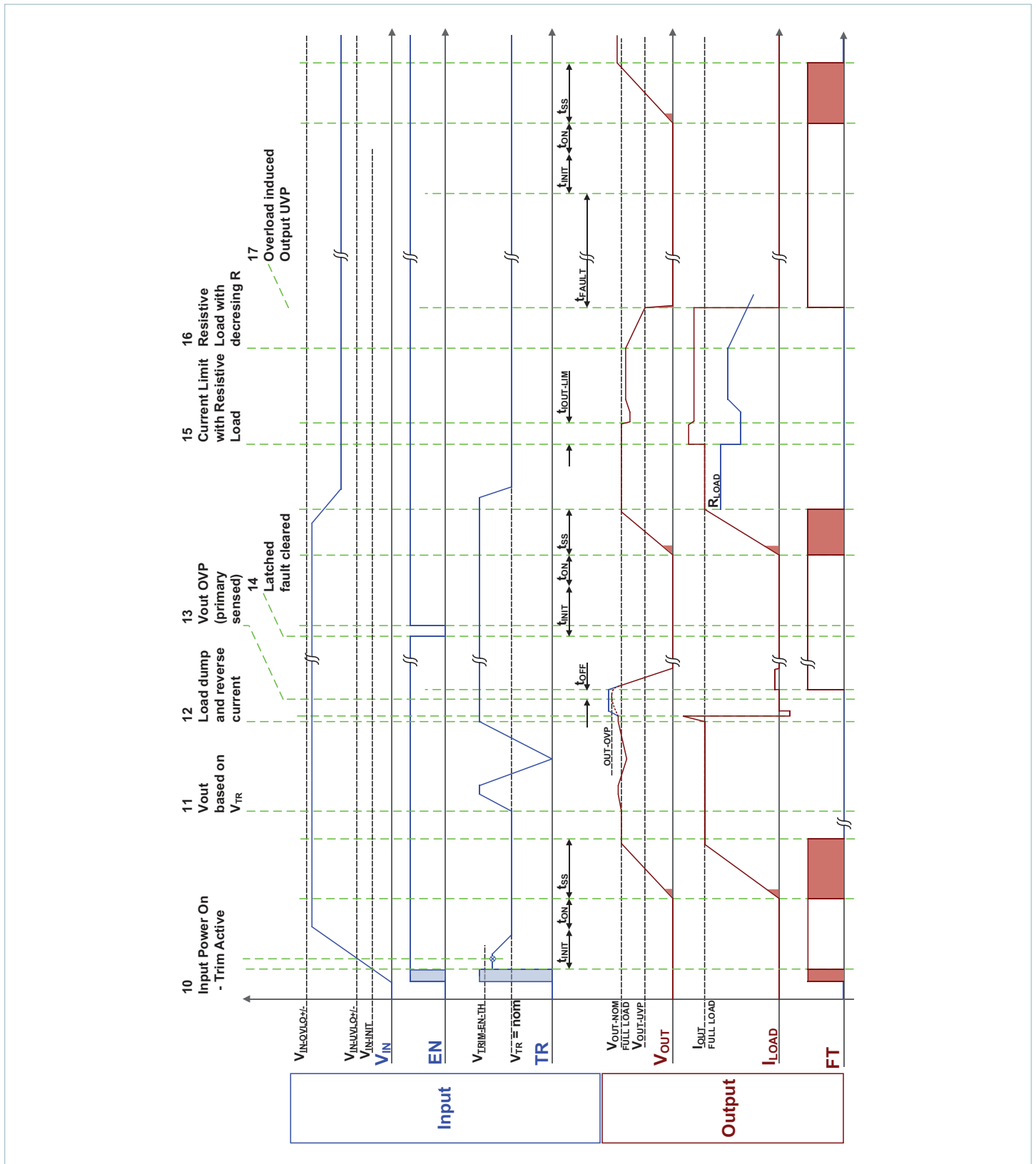

Common Typical Performance Characteristics for Array and Enhanced V_{OUT} Regulation Operation

The following figures present typical performance at $T_C = 25^\circ\text{C}$, unless otherwise noted. See associated figures for general trend data.

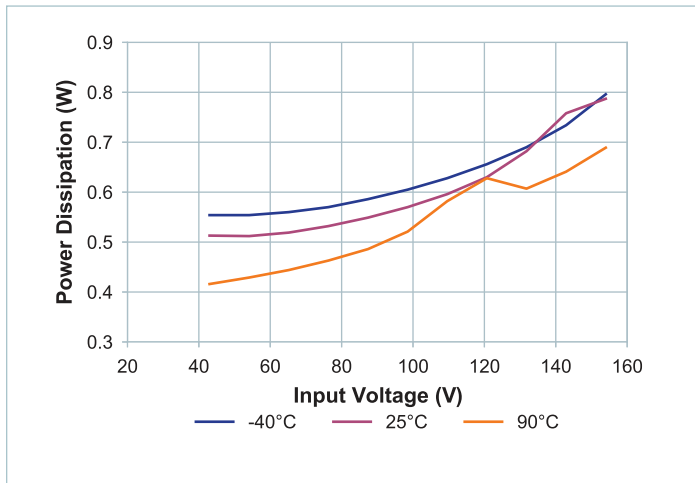

Figure 4 — Disabled power dissipation vs. V_{IN}

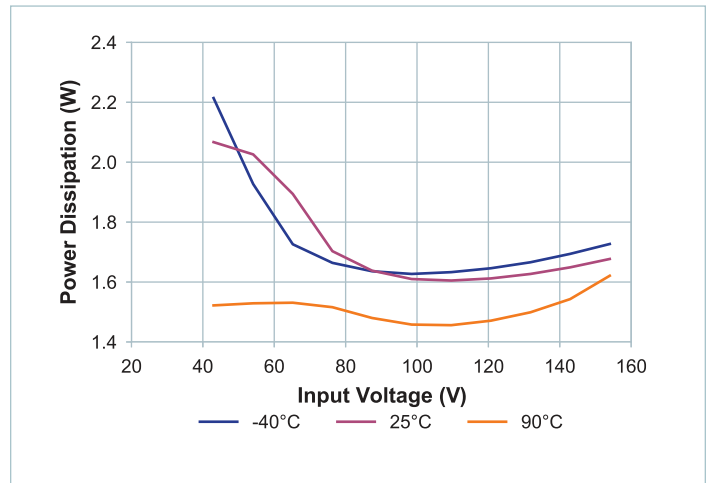

Figure 5 — No-load power dissipation vs. V_{IN} at nominal trim

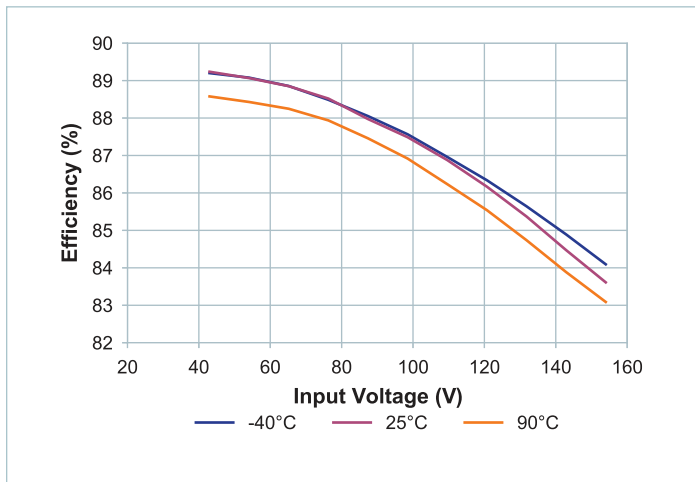

Figure 6 — Full-load efficiency vs. V_{IN} at low trim

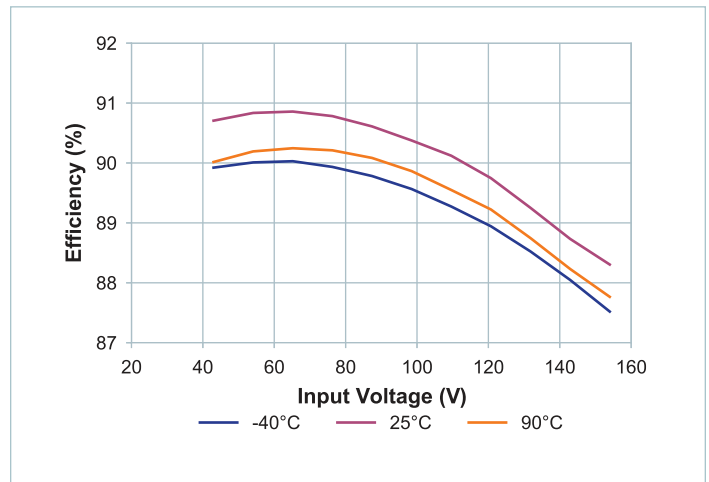

Figure 7 — Full-load efficiency vs. V_{IN} at nominal trim

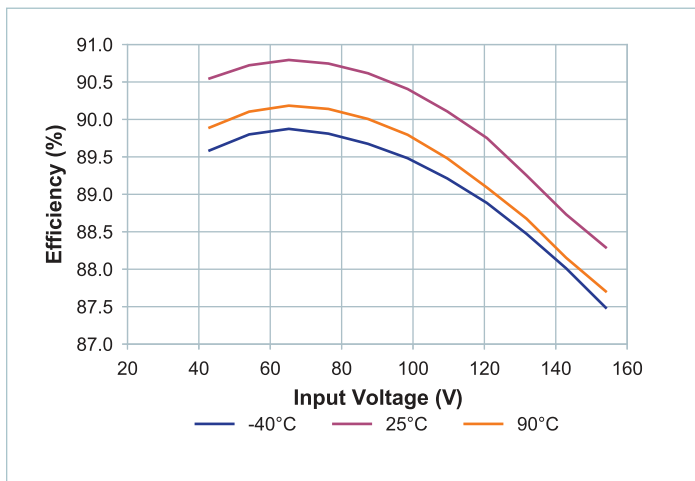

Figure 8 — Full-load efficiency vs. V_{IN} at high trim

Common Typical Performance Characteristics for Array and Enhanced V_{OUT} Regulation Operation (Cont.)

The following figures present typical performance at T_C = 25°C, unless otherwise noted. See associated figures for general trend data.

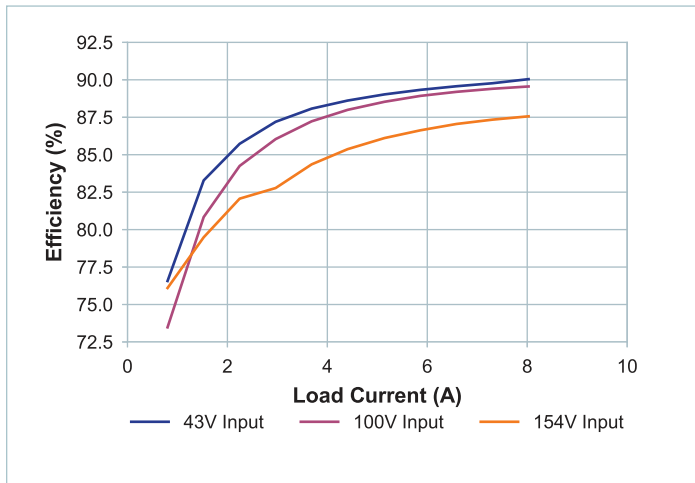

Figure 9 — Efficiency vs. load at T_{CASE} = -40°C, nominal trim

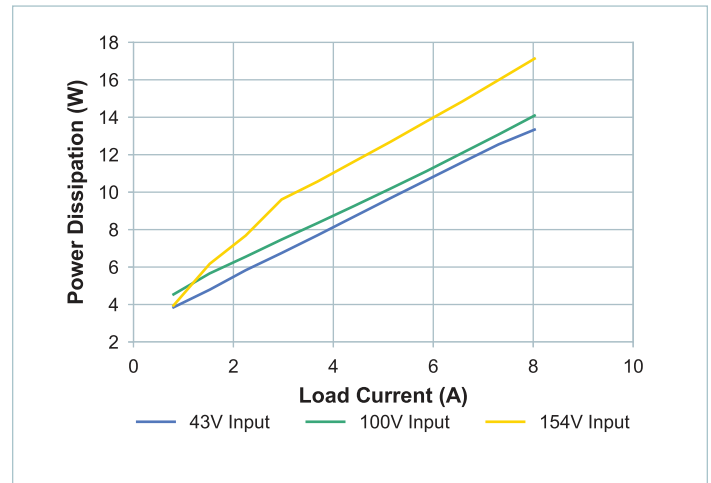

Figure 10 — Power dissipation vs. load at T_{CASE} = -40°C, nominal trim

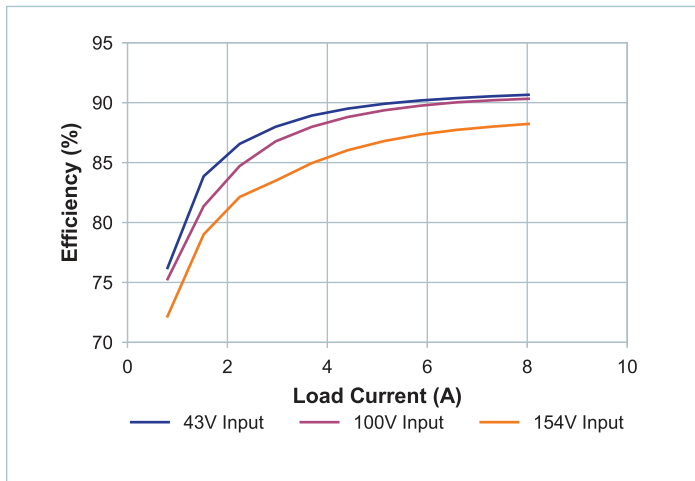

Figure 11 — Efficiency vs. load at T_{CASE} = 25°C, nominal trim

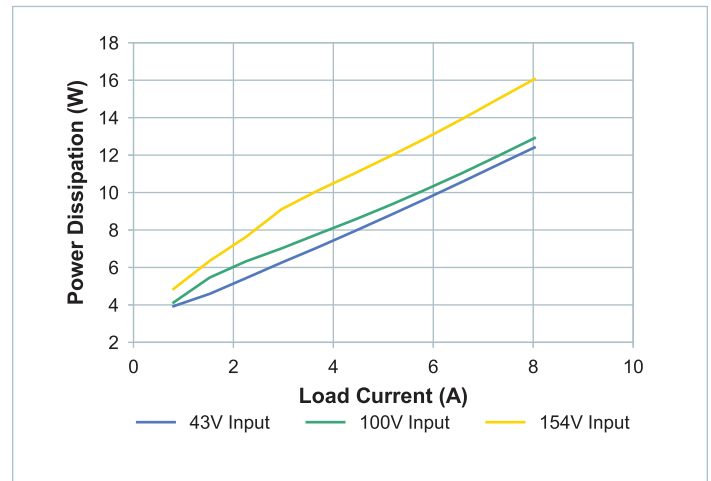

Figure 12 — Power dissipation vs. load at T_{CASE} = 25°C, nominal trim

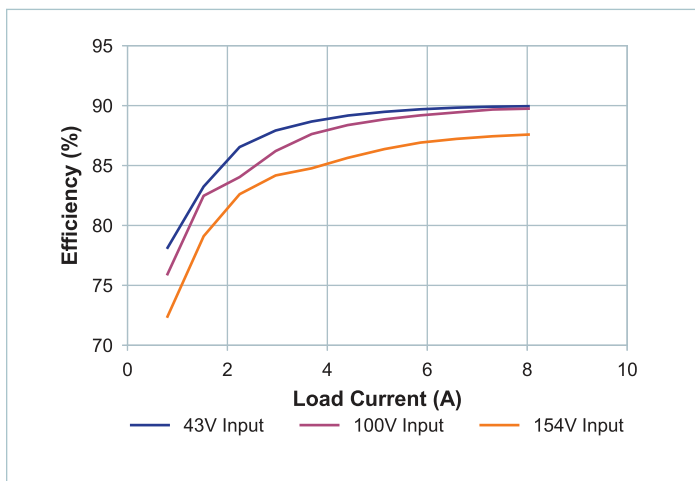

Figure 13 — Efficiency vs. load at T_{CASE} = 90°C, nominal trim

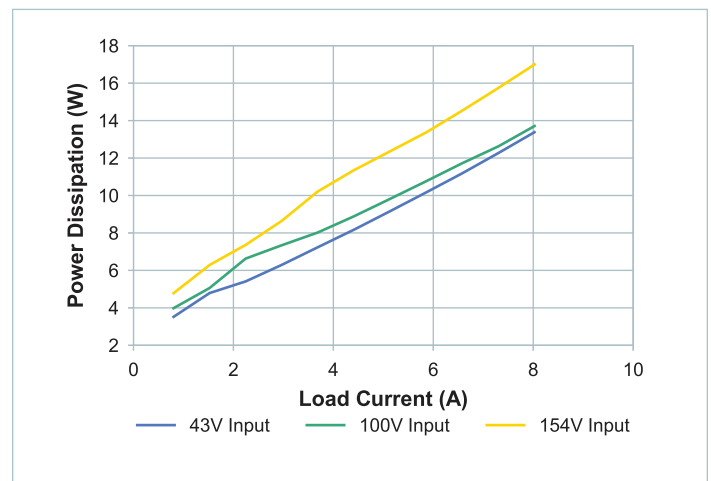

Figure 14 — Power dissipation vs. load at T_{CASE} = 90°C, nominal trim

Common Typical Performance Characteristics for Array and Enhanced V_{OUT} Regulation Operation (Cont.)

The following figures present typical performance at $T_C = 25^\circ\text{C}$, unless otherwise noted. See associated figures for general trend data.

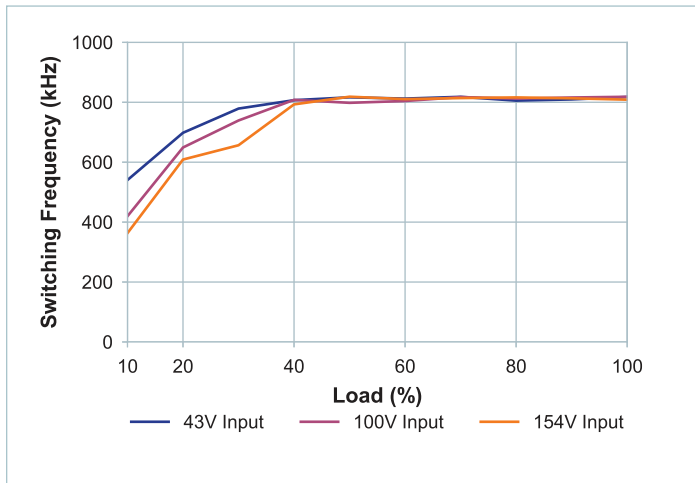

Figure 15 — Nominal powertrain switching frequency vs. load at nominal trim

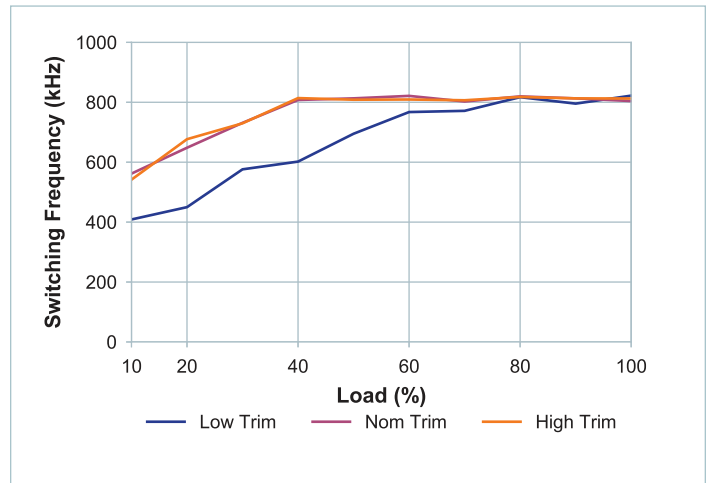

Figure 16 — Nominal powertrain switching frequency vs. load at nominal V_{IN}

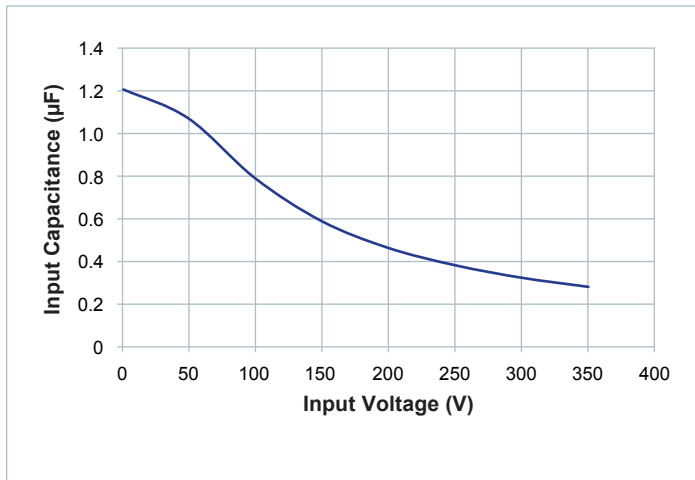

Figure 17 — Effective internal input capacitance vs. applied voltage

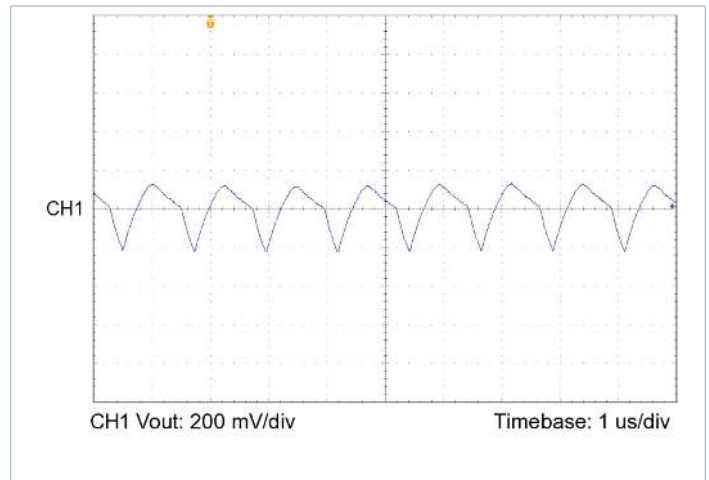

Figure 18 — Output voltage ripple, $V_{IN} = 100\text{V}$, $V_{OUT} = 15.0\text{V}$, $C_{OUT_EXT} = 470\mu\text{F}$, $R_{LOAD} = 1.875\Omega$

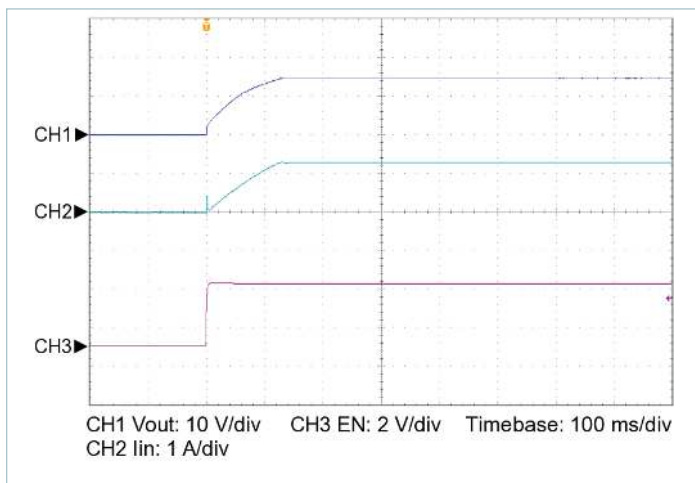

Figure 19 — Start up from EN, $V_{IN} = 100\text{V}$, $C_{OUT_EXT} = 10000\mu\text{F}$, $R_{LOAD} = 1.875\Omega$

Typical Performance Characteristics: Array Operation Only

The following figures present typical performance at $T_C = 25^\circ\text{C}$, unless otherwise noted. See associated figures for general trend data.

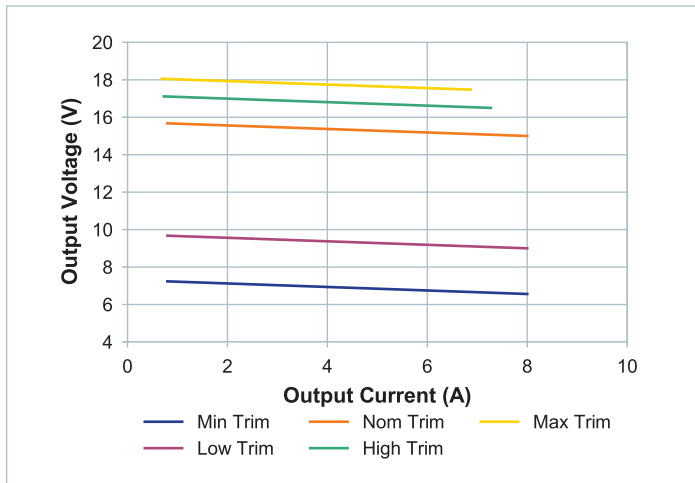

Figure 20 — Ideal V_{OUT} vs. load current, at 25°C case

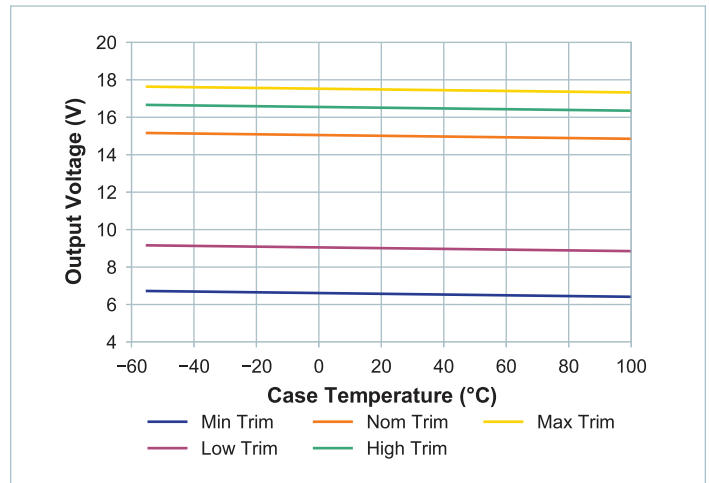

Figure 21 — Ideal V_{OUT} vs. case temperature, at full load

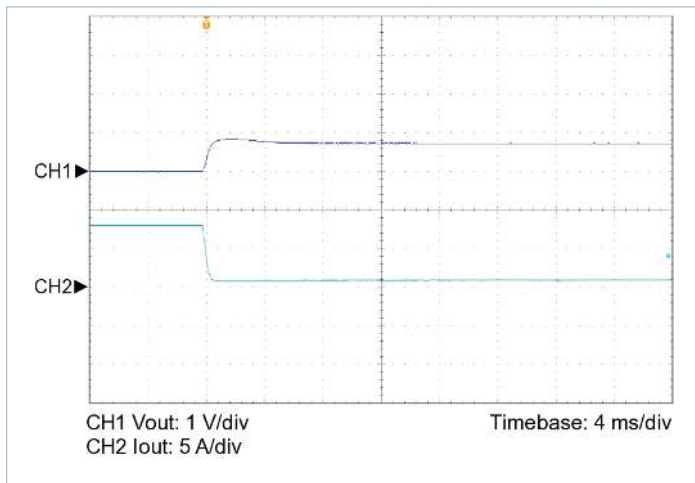

Figure 22 — 100 – 10% load transient response, $V_{IN} = 100\text{V}$, nominal trim, $C_{OUT_EXT} = 470\mu\text{F}$

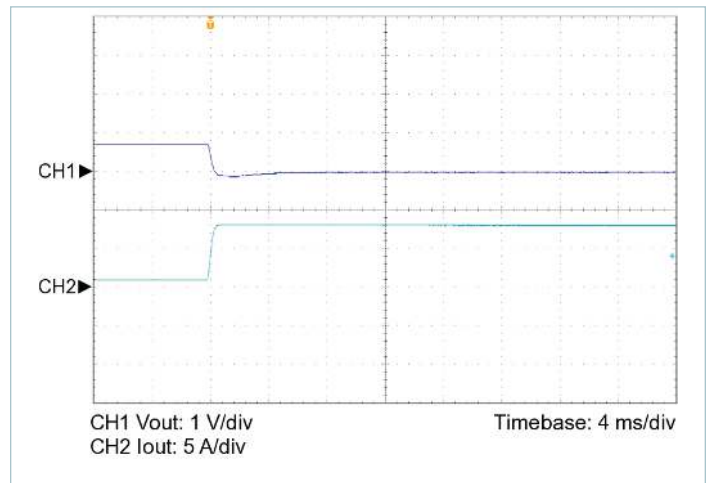

Figure 23 — 10 – 100% load transient response, $V_{IN} = 100\text{V}$, nominal trim, $C_{OUT_EXT} = 470\mu\text{F}$

Typical Performance Characteristics: Enhanced V_{OUT} Regulation Operation Only

The following figures present typical performance at $T_C = 25^\circ\text{C}$, unless otherwise noted. See associated figures for general trend data.

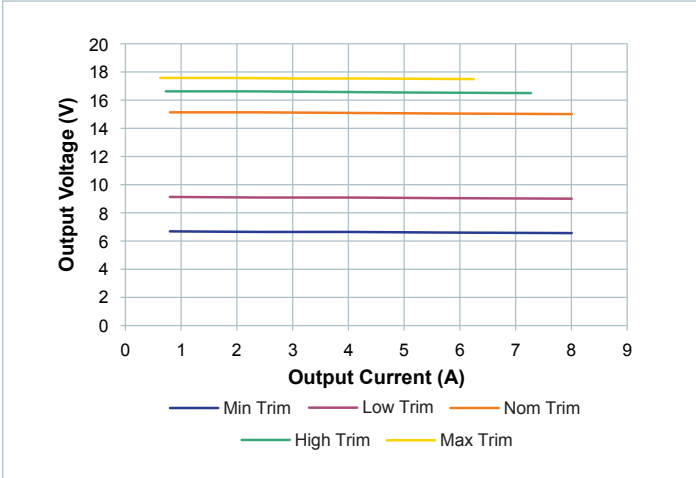

Figure 24 — Ideal V_{OUT} vs. load current, at 25°C case, operating in Enhanced V_{OUT} Regulation Mode

Pin Functions

+IN, -IN

Input power pins. -IN is the reference for all control pins, and therefore a Kelvin connection for the control signals is recommended as close as possible to the pin on the package, to reduce effects of voltage drop due to -IN currents.

+OUT, -OUT

Output power pins.

EN (Enable)

The EN pin provides two functionalities:

- Enables and disables the DCM converter.
- Selects Array mode or Enhanced V_{OUT} Regulation Mode.

The EN pin is referenced to the -IN pin of the converter. It has an internal pull-up to V_{CC} through a 10k Ω resistor.

EN is an input only, it does not pull low in the event of a fault.

Enable/Disable Control

- Output disable: when EN is pulled down externally below the disable threshold ($V_{ENABLE-DIS-TH}$), the DCM converter will be disabled.
- Output enable: when EN is allowed to pull up above the enable threshold ($V_{ENABLE-EN-TH}$) through the internal pull-up to V_{CC} , the DCM converter will be enabled.

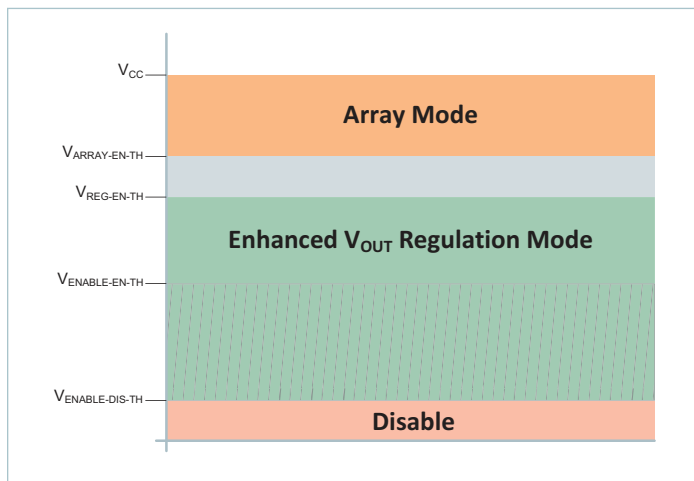

Figure 25 — EN pin voltage thresholds

Selecting Array Mode or Enhanced V_{OUT} Regulation Mode

The EN pin can also be used to select Array mode operation or Enhanced V_{OUT} Regulation Mode operation. The DCM mode of operation is dependent on the voltage seen by the DCM at its EN pin at first start up following application of V_{IN} . The DCM will latch in selected mode of operation at the end of soft start and persist in that same mode until loss of input voltage.

At the first start up after application of V_{IN} , if EN is allowed to float to:

- A value above $V_{ENABLE-EN-TH}$ but below $V_{REG-EN-TH}$, the DCM will implement Enhanced V_{OUT} Regulation Mode.
- A value above $V_{ARRAY-EN-TH}$ and up to V_{CC} , the DCM will implement array mode operation.

Note that the selected mode of operation is not changed when a DCM recovers from any fault condition, or after a disable event through EN. The operation mode is reset only with cycling of input power.

TR (Trim)

The TR pin is used to select the trim mode and to trim the output voltage of the DCM converter. The TR pin has an internal pull-up to V_{CC} through a 10.0k Ω resistor.

The DCM will latch trim behavior at application of V_{IN} (once V_{IN} exceeds $V_{IN-UVLO+}$) and persist in that same behavior until loss of input voltage

- At application of V_{IN} , if TR is sampled at above $V_{TRIM-DIS-TH}$, the module will latch in a non-trim mode, and will ignore the TR input for as long as V_{IN} is present.
- At application of V_{IN} , if TR is sampled at below $V_{TRIM-EN-TH}$, the TR will serve as an input to control the real time output voltage, relative to full load, 25°C. It will persist in this behavior until V_{IN} is no longer present.

If trim is active when the DCM is operating, the TR pin provides dynamic trim control at a typical 30Hz of -3dB bandwidth over the output voltage. TR also decreases the current limit threshold when trimming above $V_{OUT-NOM}$.

FT (Fault)

The FT pin provides a Fault signal.

Any time the module is enabled and has not recognized a fault, the FT pin is inactive. FT has an internal 499k Ω pull-up to V_{CC} , therefore a shunt resistor, R_{SHUNT} , of approximately 50k Ω can be used to ensure the LED is completely off when there is no fault, per the diagram below.

Whenever the powertrain stops (due to a fault protection or disabling the module by pulling EN low), the FT pin becomes active and provides current to drive an external circuit.

When active, FT pin drives to V_{CC} , with up to 4mA of external loading. Module may be damaged from an overcurrent FT drive, thus a resistor in series for current limiting is recommended.

The FT pin becomes active momentarily when the module starts up.

Typical External Circuits for Signal Pins (TR, EN, FT)

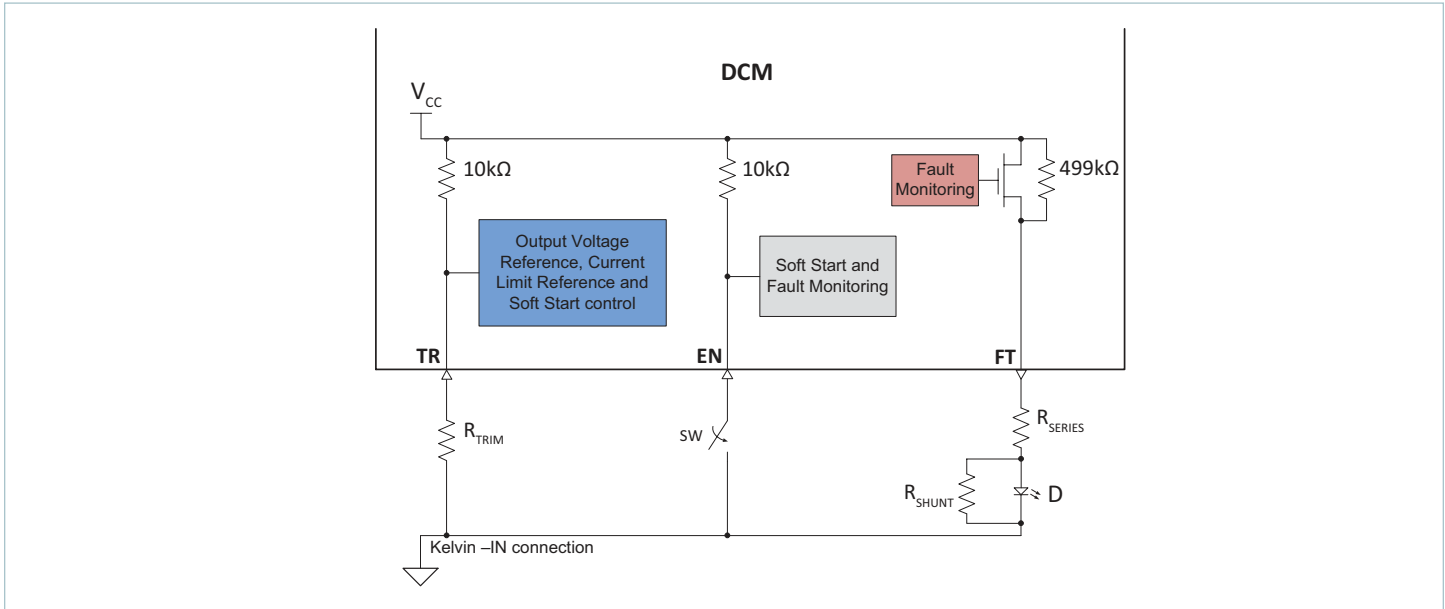

Design Guidelines

Building Blocks and System Design

The DCM converter input accepts the full 43 – 154V range, and it generates an isolated trimmable 15.0V_{DC} output. Multiple DCMs may be paralleled for higher power capacity via wireless load sharing, even when they are operating off of different input voltage supplies.

The DCM converter provides a regulated output voltage around defined nominal load line and temperature coefficients. The load line and temperature coefficients enable configuration of an array of DCM converters which manage the output load with no share bus among modules. Downstream regulators may be used to provide tighter voltage regulation, if required.

The DCM2322xA5N17A2y6z may be used in standalone applications where the output power requirements are up to 120W. However, it is easily deployed as arrays of modules to increase power handling capacity. Arrays of up to eight units have been qualified for 1280W capacity. Application of DCM converters in an array requires no de-rating of the maximum available power versus what is specified for a single module.

Note: For more information on operation of single DCM, refer to “Single DCM as an Isolated, Regulated DC-DC Converter” application note [AN:029](#).

Soft Start

When the DCM starts, it will go through a soft start. The soft-start routine ramps the output voltage by modulating the internal error amplifier reference. This causes the output voltage to approximate a piecewise linear ramp. The output ramp finishes when the voltage reaches either the nominal output voltage, or the trimmed output voltage in cases where trim mode is active.

During soft start, the maximum load current capability is reduced. Until V_{OUT} achieves at least $V_{OUT-FL-THRESH}$, the output current must be less than $I_{OUT-START}$ in order to guarantee start up. Note that this is current available to the load, above that which is required to charge the output capacitor.

Nominal Output Voltage Load Line

DCM in Array Mode

Throughout this document, the programmed output voltage (either the specified nominal output voltage if trim is inactive or the trimmed output voltage if trim is active), is specified at full load and at room temperature. The actual output voltage of the DCM is given by the programmed trimmed output voltage, with modification based on load and temperature. The nominal output voltage is 15.0V, and the actual output voltage will match this at full load and room temperature with trim inactive.

The largest modification to the actual output voltage compared to the programmed output is due to the 5.263% $V_{OUT-NOM}$ load line, which for this model corresponds to $\Delta V_{OUT-LOAD}$ of 0.7895V. As the load is reduced, the internal error amplifier reference, and by extension the output voltage, rises in response. This load line is the primary enabler of the wireless current sharing among an array of DCMs.

The load line impact on the output voltage is absolute, and does not scale with programmed trim voltage.

For a given programmed output voltage, the actual output voltage versus load current at nominal trim and room temperature is given by the following equation:

$$V_{OUT} \text{ at } 25^{\circ}\text{C} = 15.0 + 0.7895 \cdot (1 - I_{OUT} / 8.00) \quad (1)$$

DCM in Enhanced V_{OUT} Regulation Mode

In Enhanced V_{OUT} Regulation Mode, output voltage is not a function of load line.

Nominal Output Voltage Temperature Coefficient

DCM in Array Mode

A second additive term to the programmed output voltage is based on the temperature of the module. This term permits improved thermal balancing among modules in an array, especially when the factory nominal trim point is utilized (trim mode inactive). This term is much smaller than the load line described above, representing only a $-2.00\text{mV}/^\circ\text{C}$ change. Regulation coefficient is relative to 25°C .

For nominal trim and full load, the output voltage relates to the temperature according to the following equation:

$$V_{OUT-FL} = 15.0 - 2.000 \cdot 0.001 \cdot (T_{INT} - 25) \quad (2)$$

where T_{INT} is in $^\circ\text{C}$.

The impact of temperature coefficient on the output voltage is absolute and does not scale with trim or load.

DCM in Enhanced V_{OUT} Regulation Mode

In Enhanced V_{OUT} Regulation Mode, output voltage is not a function of temperature coefficient.

Trim Mode and Output Trim Control

DCM in Array and Enhanced V_{OUT} Regulation Modes

When the input voltage is initially applied to a DCM, and after t_{INIT} elapses, the trim pin voltage V_{TR} is sampled. The TR pin has an internal pull-up resistor to V_{CC} , so unless external circuitry pulls the pin voltage lower, it will pull up to V_{CC} . If the initially sampled trim pin voltage is higher than $V_{TRIM-DIS}$, then the DCM will disable trimming as long as the V_{IN} remains applied. In this case, for all subsequent operation the output voltage will be programmed to the nominal. This minimizes the support components required for applications that only require the nominal rated V_{OUT} , and also provides the best output set-point accuracy, as there are no additional errors from external trim components.

If at initial application of V_{IN} , the TR pin voltage is prevented from exceeding $V_{TRIM-EN}$, then the DCM will activate trim mode, and it will remain active for as long as V_{IN} is applied.

V_{OUT} set point under full load and room temperature can be calculated using the equation below:

$$V_{OUT-FL \text{ at } 25^\circ\text{C}} = 6.56 + (11.397 \cdot V_{TR} / V_{CC}) \quad (3)$$

Note that the trim mode is not changed when a DCM recovers from any fault condition or being disabled.

Module performance is guaranteed through output voltage trim range $V_{OUT-TRIMMING}$. If V_{OUT} is trimmed above this range, then certain combinations of line and load transient conditions may trigger the output OVP.

Overall Output Voltage Transfer Function

DCM in Array Mode

Taking load line (Equation 1), temperature coefficient (Equation 2) and trim (Equation 3) into account, the general equation relating the DC V_{OUT} to programmed trim (when active), load and temperature is given by:

$$V_{OUT} = 6.56 + (11.397 \cdot V_{TR} / V_{CC}) + 0.7895 \cdot (1 - I_{OUT} / 8.00) - 2.000 \cdot 0.001 \cdot (T_{INT} - 25) + \Delta V_{OUT-LL} \quad (4)$$

DCM in Enhanced V_{OUT} Regulation Mode

In Enhanced V_{OUT} Regulation Mode, only trim (Equation 3) is applicable. The general equation relating the DC V_{OUT} to programmed trim is given by:

$$V_{OUT} = 6.56 + (11.397 \cdot V_{TR} / V_{CC}) + \Delta V_{OUT-LL} \quad (5)$$

Finally, note that when the load current is below 10% of the rated capacity, there is an additional ΔV which may add to the output voltage, depending on the line voltage which is related to light-load boosting. Please see the section on light-load boosting below for details.

Use 0V for ΔV_{OUT-LL} when load is above 10% of rated load. See section on light-load boosting operation for light-load effects on output voltage.

Output Current Limit

The DCM features a fully operational current limit which effectively keeps the module operating inside the Safe Operating Area (SOA) for all valid trim and load profiles. The current limit approximates a "brick wall" limit, where the output current is prevented from exceeding the current limit threshold by reducing the output voltage via the internal error amplifier reference. The current limit threshold at nominal trim and below is typically 120% of rated output current, but it can vary between 100% to 140%. In order to preserve the SOA, when the converter is trimmed above the nominal output voltage, the current limit threshold is automatically reduced to limit the available output power.

When the output current exceeds the current limit threshold, current limit action is held off by 1ms, which permits the DCM to momentarily deliver higher peak output currents to the load. Peak output power during this time is still constrained by the internal Power Limit of the module. The fast Power Limit and relatively slow Current Limit work together to keep the module inside the SOA. Delaying entry into current limit also permits the DCM to minimize droop voltage for load steps.

Sustained operation in current limit is permitted, and no de-rating of output power is required, even in an array configuration.

Some applications may benefit from well-matched current distribution, in which case fine tuning sharing via the trim pins permits control over sharing. The DCM does not require this for proper operation, due to the power limit and current limit behaviors described here.

Current limit can reduce the output voltage to as little as the UVP threshold ($V_{OUT-UVP}$). Below this minimum output voltage compliance level, further loading will cause the module to shut down due to the output undervoltage fault protection.

Line Impedance, Input Slew Rate and Input Stability Requirements

Connect a high-quality, low-noise power supply to the +IN and –IN terminals. Additional capacitance may have to be added between +IN and –IN to make up for impedances in the interconnect cables as well as deficiencies in the source.

Excessive source impedance can bring about system stability issues for a regulated DC-DC converter, and must either be avoided or compensated by filtering components. A 100 μ F input capacitor is the minimum recommended in case the source impedance is insufficient to satisfy stability requirements.

Additional information can be found in the filter design application note [AN:023](#).

Please refer to this [input filter design tool](#) to ensure input stability.

Ensure that the input voltage slew rate is less than 1V/ μ s, otherwise a pre-charge circuit is required for the DCM input to control the input voltage slew rate and prevent overstress to input stage components.

Input Fuse Selection

The DCM is not internally fused in order to provide flexibility in configuring power systems. Input line fusing is recommended at the system level, in order to provide thermal protection in case of catastrophic failure. The fuse shall be selected by closely matching system requirements with the following characteristics:

- Current rating
(usually greater than the DCM converter's maximum current)
- Maximum voltage rating
(usually greater than the maximum possible input voltage)
- Ambient temperature
- Breaking capacity per application requirements
- Nominal melting I²t
- Recommended fuse:
See [Safety Approvals](#) for recommended fuse

Fault Handling

Input Undervoltage Fault Protection (UVLO)

The converter's input voltage is monitored to detect an input undervoltage condition. If the converter is not already running, then it will ignore enable commands until the input voltage is greater than $V_{IN-UVLO+}$. If the converter is running and the input voltage falls below $V_{IN-UVLO-}$, the converter recognizes a fault condition, the powertrain stops switching, and the output voltage of the unit falls.

Input voltage transients which fall below UVLO for less than t_{UVLO} may not be detected by the fault protection logic, in which case the converter will continue regular operation. No protection is required in this case.

Once the UVLO fault is detected by the fault protection logic, the converter shuts down and waits for the input voltage to rise above $V_{IN-UVLO+}$. Provided the converter is still enabled, it will then restart.

Input Overvoltage Fault Protection (OVLO)

The converter's input voltage is monitored to detect an input overvoltage condition. When the input voltage is more than the $V_{IN-OVLO+}$, a fault is detected, the powertrain stops switching, and the output voltage of the converter falls.

After an OVLO fault occurs, the converter will wait for the input voltage to fall below $V_{IN-OVLO-}$. Provided the converter is still enabled, the powertrain will restart.

The powertrain controller itself also monitors the input voltage. Transient OVLO events which have not yet been detected by the fault sequence logic may first be detected by the controller if the input slew rate is sufficiently large. In this case, powertrain switching will immediately stop. If the input voltage falls back in range before the fault sequence logic detects the out of range condition, the powertrain will resume switching and the fault logic will not interrupt operation. Regardless of whether the powertrain is running at the time or not, if the input voltage does not recover from OVLO before t_{OVLO} , the converter fault logic will detect the fault.

Output Undervoltage Fault Protection (UVP)

The converter determines that an output overload or short circuit condition exists by measuring its primary sensed output voltage and the output of the internal error amplifier. In general, whenever the powertrain is switching and the primary-sensed output voltage falls below $V_{OUT-UVP}$ threshold, a short circuit fault will be registered. Once an output undervoltage condition is detected, the powertrain immediately stops switching, and the output voltage of the converter falls. The converter remains disabled for a time t_{FAULT} . Once recovered and provided the converter is still enabled, the powertrain will again enter the soft-start sequence after t_{INIT} and t_{ON} .

Temperature Fault Protections (OTP)

The fault logic monitors the internal temperature of the converter. If the measured temperature exceeds $T_{INT-OTP}$, a temperature fault is registered. As with the undervoltage fault protection, once a temperature fault is registered, the powertrain immediately stops switching, the output voltage of the converter falls, and the converter remains disabled for at least time t_{FAULT} . Then, the converter waits for the internal temperature to return to below $T_{INT-OTP}$ before recovering. Provided the converter is still enabled, the DCM will restart after t_{INIT} and t_{ON} .

Output Overvoltage Fault Protection (OVP)

The converter monitors the output voltage during each switching cycle by a corresponding voltage reflected to the primary side control circuitry. If the primary sensed output voltage exceeds $V_{OUT-OVP}$, the OVP fault protection is triggered. The control logic disables the powertrain, and the output voltage of the converter falls.

This type of fault is latched, and the converter will not start again until the latch is cleared. Clearing the fault latch is achieved by either disabling the converter via the EN pin, or else by removing the input power such that the input voltage falls below $V_{IN-INIT}$.

External Output Capacitance

The DCM converter internal compensation requires a minimum external output capacitor. An external capacitor in the range of 470 – 10000 μ F with ESR of 10m Ω is required, per DCM for control loop compensation purposes.

However some DCM models require an increase to the minimum external output capacitor value in certain loading and trim condition. In applications where the load can go below 10% of rated load but the output trim is held constant, the range of output capacitor required is given by $C_{OUT-EXT-TRANS}$ in the Electrical Specifications table. If the load can go below 10% of rated load and the DCM output trim is also dynamically varied, the range of output capacitor required is given by $C_{OUT-EXT-TRANS-TRIM}$ in the Electrical Specifications table.

Light-Load Boosting

Under light-load conditions, the DCM converter may operate in light-load boosting depending on the line voltage. Light-load boosting occurs whenever the internal power consumption of the converter combined with the external output load is less than the minimum power transfer per switching cycle. In order to maintain regulation, the error amplifier will switch the powertrain off and on repeatedly, to effectively lower the average switching frequency, and permit operation with no external load. During the time when the powertrain is off, the module internal consumption is significantly reduced, and so there is a notable reduction in no-load input power in light-load boosting. When the load is less than 10% of rated I_{OUT} , the output voltage may rise by a maximum of 1.58V, above the output voltage calculated from trim, temperature and load line conditions.

Thermal Design

Based on the safe thermal operating area shown on page 6, the full rated power of the DCM2322xA5N17A2y6z can be processed provided that the top, bottom and leads are all held below 95°C. These curves highlight the benefits of dual sided thermal management, but also demonstrate the flexibility of the Vicor ChiP™ platform for customers who are limited to cooling only the top or the bottom surface.

The OTP sensor is located on the top side of the internal PCB structure. Therefore in order to ensure effective overtemperature fault protection, the case bottom temperature must be constrained by the thermal solution such that it does not exceed the temperature of the case top.

The ChiP package provides a high degree of flexibility in that it presents three pathways to remove heat from internal power dissipating components. Heat may be removed from the top surface, the bottom surface and the leads. The extent to which these three surfaces are cooled is a key component for determining the maximum power that is available from a ChiP, as can be seen from Figure 26.

Since the ChiP has a maximum internal temperature rating, it is necessary to estimate this internal temperature based on a real thermal solution. Given that there are three pathways to remove heat from the ChiP, it is helpful to simplify the thermal solution into a roughly equivalent circuit where power dissipation is modeled as a current source, isothermal surface temperatures are represented as voltage sources and the thermal resistances are represented as resistors. Figure 26 shows the “thermal circuit” for a DCM2322 ChiP in an application where case top, case bottom and leads are cooled. In this case, the DCM power dissipation is PD_{TOTAL} and the three surface temperatures are represented as T_{CASE_TOP}, T_{CASE_BOTTOM}, and T_{LEADS}. This thermal system can now be very easily analyzed with simple resistors, voltage sources and a current source.

This analysis provides an estimate of heat flow through the various pathways as well as internal temperature.

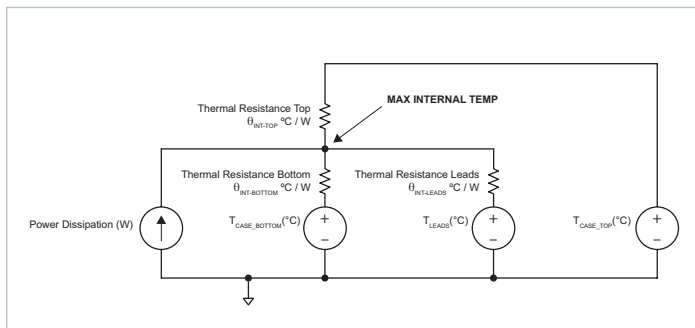

Figure 26 — Double-side cooling and leads thermal model

Alternatively, equations can be written around this circuit and analyzed algebraically:

$$T_{INT} - PD_1 \cdot \theta_{INT-TOP} = T_{CASE_TOP}$$

$$T_{INT} - PD_2 \cdot \theta_{INT-BOTTOM} = T_{CASE_BOTTOM}$$

$$T_{INT} - PD_3 \cdot \theta_{INT-LEADS} = T_{LEADS}$$

$$PD_{TOTAL} = PD_1 + PD_2 + PD_3$$

Where T_{INT} represents the internal temperature and PD₁, PD₂, and PD₃ represent the heat flow through the top side, bottom side and leads respectively.

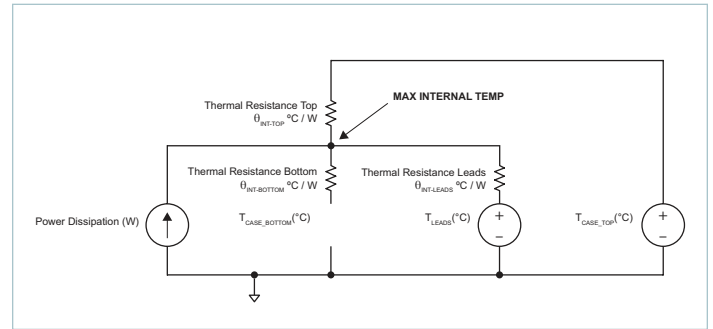

Figure 27 — One-side cooling and leads thermal model

Figure 27 shows a scenario where there is no bottom-side cooling. In this case, the heat flow path to the bottom is left open and the equations now simplify to:

$$T_{INT} - PD_1 \cdot \theta_{INT-TOP} = T_{CASE_TOP}$$

$$T_{INT} - PD_3 \cdot \theta_{INT-LEADS} = T_{LEADS}$$

$$PD_{TOTAL} = PD_1 + PD_3$$

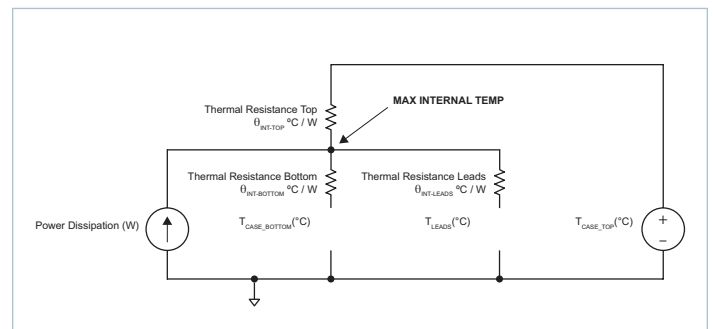

Figure 28 — One-side cooling thermal model

Figure 28 shows a scenario where there is no bottom side and leads cooling. In this case, the heat flow path to the bottom is left open and the equations now simplify to:

$$T_{INT} - PD_1 \cdot \theta_{INT-TOP} = T_{CASE_TOP}$$

$$PD_{TOTAL} = PD_1$$

Vicor provides a suite of online tools, including a simulator and thermal estimator which greatly simplify the task of determining whether or not a DCM thermal configuration is sufficient for a given condition. These tools can be found at: www.vicorpower.com/powerbench.

Symbol	Thermal Impedance (°C/W)	Definition of Estimated Thermal Resistance
θ _{INT-TOP}	4.5	to maximum-temperature internal component from isothermal top
θ _{INT-LEADS}	9.5	to maximum-temperature internal component from isothermal leads
θ _{INT-BOTTOM}	4.9	to maximum-temperature internal component from isothermal bottom
Thermal Capacity		
10.3Ws/°C		

Table 1 — Thermal data

Array Operation

A decoupling network is needed to facilitate paralleling:

- An output inductor should be added to each DCM, before the outputs are bussed together to provide decoupling.
- Each DCM needs a separate filter, even if the multiple DCMs share the same input voltage source. These filters limit the ripple current reflected from each DCM, and also help suppress generation of beat frequency currents that can result when multiple powertrains input stages are permitted to directly interact.

If signal pins (TR, EN, FT) are not used, they can be left floating, and DCM will work in the nominal output condition.

When common-mode noise in the input side is not a concern, TR and EN can be driven and FT received using a single Kelvin connection to the shared -IN as a reference.

Note: For more information on parallel operation of DCMs, refer to "Parallel DCMs" application note [AN:030](#).

An example of DCM paralleling circuit is shown in Figure 29.

Filter components

Input filter: The choice of the input filter components varies up on the low line and maximum output power of the DCM. Refer to the Filtering Guidelines Introduction section in the [DCM Design Guide](#) to design an input filter.

Output filter:

Reference Designator	Value	Mfg. Part Number & Count/DCM
C_{2_x}	80 μ F	GRM32EC72A106KE05L, #8
L_{2_x}	0.33 μ H	744309033, #1
R_{dm_x}	1.5 Ω	Generic
L_{b_x}	72nH	IFLR2727EZER72NM01, #1

$C_{OUT-EXT-x}$: electrolytic or tantalum capacitor with at least 10m Ω ESR, 470 μ F $\leq C_{OUT-EXT} \leq 10000\mu$ F;

C_3, C_4 : additional ceramic /electrolytic capacitors, if needed for output ripple filtering;

In order to help sensitive signal circuits reject potential noise, additional components are recommended:

R_{2_x} : 301 Ω , facilitate noise attenuation for TR pin;

FB_{1_x}, C_{5_x} : FB_1 is a ferrite bead with an impedance of at least 10 Ω at 100MHz. C_{5_x} can be a ceramic capacitor of 0.1 μ F. Facilitate noise attenuation for EN pin.

Note: Use an RCR filter network as suggested in the application note AN:030 to reduce the noise on the signal pins.

Note: In case of the excessive line inductance, a properly sized decoupling capacitor $C_{DECOUPLE}$ is required as shown in Figure 29 and Figure 30.

When common-mode noise rejection in the input side is needed, common-mode chokes can be added in the input side of each DCM. An example of DCM paralleling circuit is shown in Figure 30.

Notice that each group of control pins need to be individually driven and isolated from the other groups control pins. This is because -IN of each DCM can be at a different voltage due to the common mode chokes. Attempting to share control pin circuitry could lead to incorrect behavior of the DCMs.

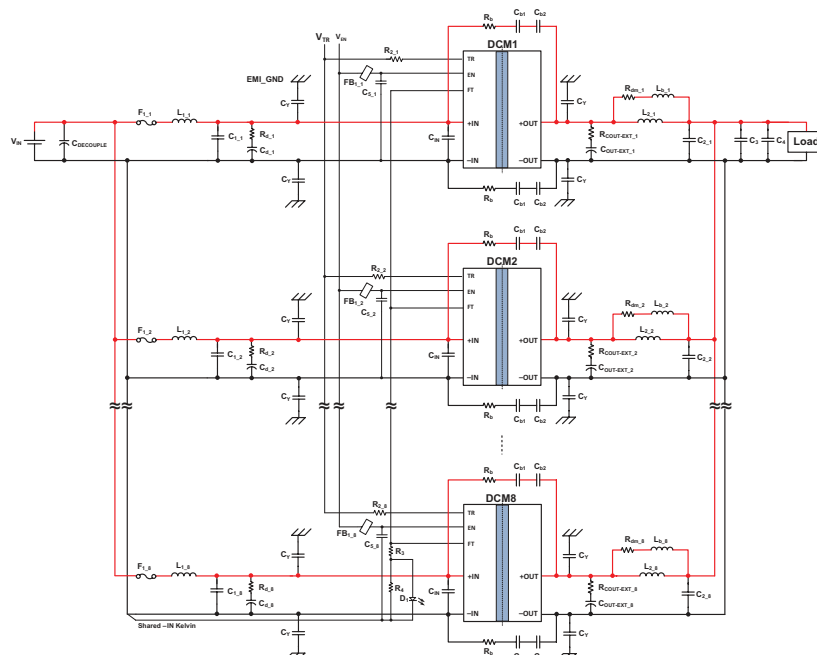

Note: C_{IN} , R_b , C_{b1} and C_{b2} are required components for proper operation of the DCM. See required components table on page 2.

Figure 29 — DCM paralleling configuration circuit 1

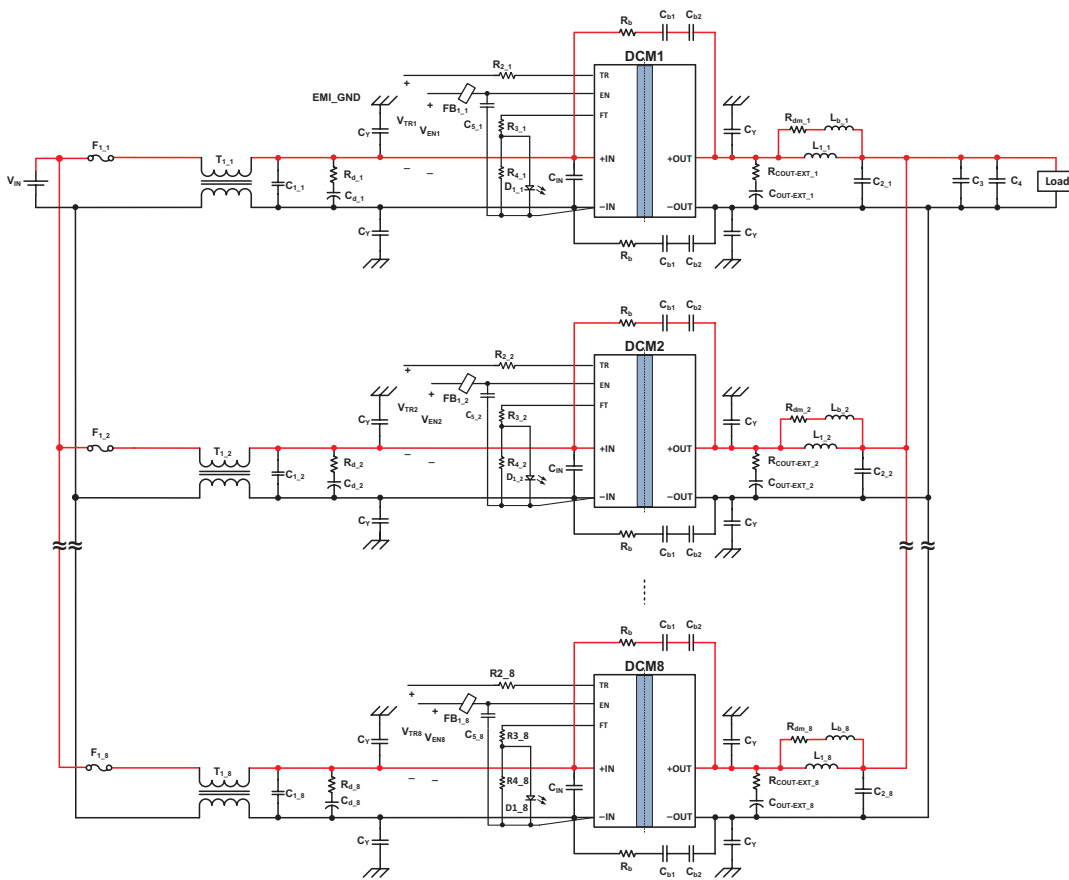

Note: C_{IN} , R_b , C_{b1} and C_{b2} are required components for proper operation of the DCM. See required components table on page 2.

Figure 30 — DCM paralleling configuration circuit 2

Notice that each group of control pins needs to be individually driven and isolated from the other groups control pins. This is because $-IN$ of each DCM can be at a different voltage due to the common-mode chokes. Attempting to share control pin circuitry could lead to incorrect behavior of the DCMs.

An array of DCMs used at the full array-rated power may generally have one or more DCMs operating at current limit, due to sharing errors. Load sharing is functionally managed by the load line. Thermal balancing is improved by the nominal effective temperature coefficient of the output voltage set point.

DCMs in current limit will operate with higher output current or power than the rated levels. Therefore the following Thermal Safe Operating Area plot should be used for arrays or loads that drive the DCM in to current limit for sustained operation.

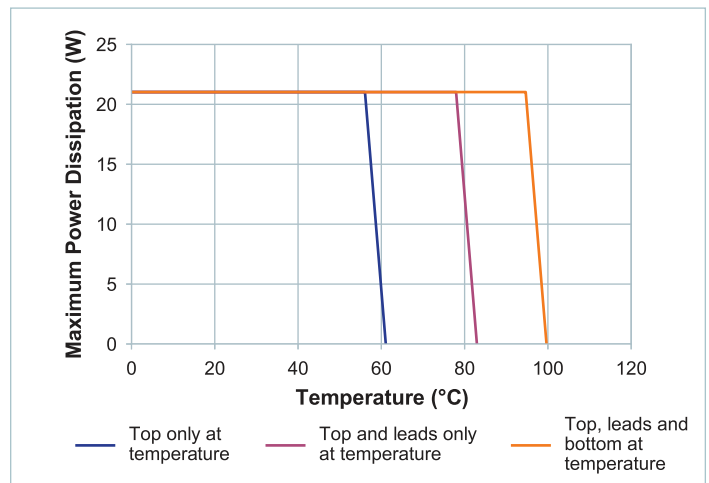
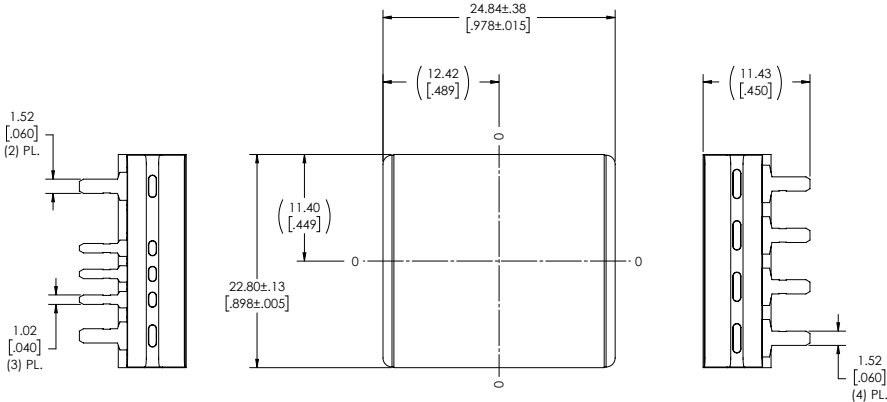

Figure 31 — Thermal specified operating area: max power dissipation vs. case temp for arrays or current-limited operation

DCM Module Product Outline Drawing Recommended PCB Footprint and Pinout

2322 THRU HOLE

(Reference DWG # 40292 Rev 5)



TOP VIEW (COMPONENT SIDE)

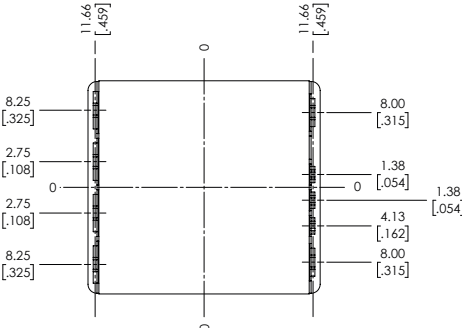
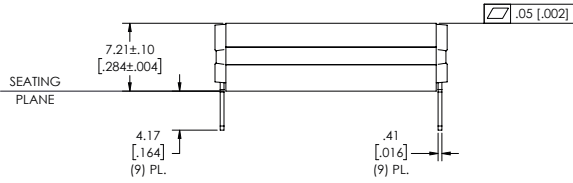

BOTTOM VIEW

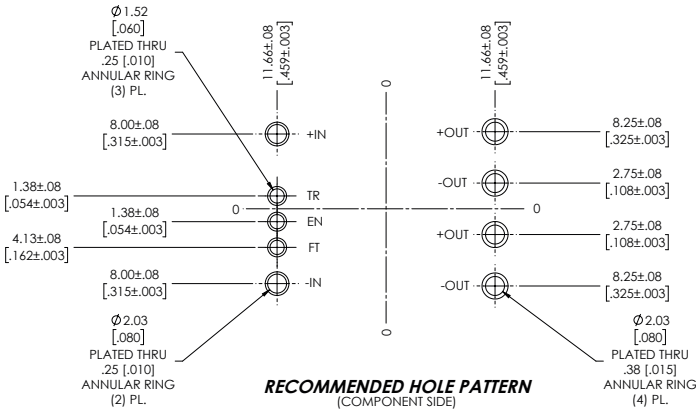

RECOMMENDED HOLE PATTERN (COMPONENT SIDE)

NOTES:
 1- UNLESS OTHERWISE SPECIFIED DIMENSIONS ARE MM [INCH]
 2- TOLERANCES ARE:
 DECIMALS
 X.XX [X.XX] = ±0.25 [0.01]
 X.XXX [X.XXX] = ±0.127 [0.005]
 ANGLES = ±1°

Revision History

Revision	Date	Description	Page Number(s)
1.0	08/13/19	Initial release	N/A
1.1	09/05/19	Updated signal pin names on mechanical drawing	29
1.2	01/30/20	Output voltage regulation specification format change	8
1.3	11/04/22	Updated agency approvals Corrected equation 1 notes Revised array operation section Added insulation resistance specification Added C-grade part number and related specs Updated format, pages added	1, 5 24 29 5 5, 7, 8 ALL

Vicor's comprehensive line of power solutions includes high density AC-DC and DC-DC modules and accessory components, fully configurable AC-DC and DC-DC power supplies, and complete custom power systems.

Information furnished by Vicor is believed to be accurate and reliable. However, no responsibility is assumed by Vicor for its use. Vicor makes no representations or warranties with respect to the accuracy or completeness of the contents of this publication. Vicor reserves the right to make changes to any products, specifications, and product descriptions at any time without notice. Information published by Vicor has been checked and is believed to be accurate at the time it was printed; however, Vicor assumes no responsibility for inaccuracies. Testing and other quality controls are used to the extent Vicor deems necessary to support Vicor's product warranty. Except where mandated by government requirements, testing of all parameters of each product is not necessarily performed.

Specifications are subject to change without notice.

Visit <https://www.vicorpower.com/dc-dc/isolated-regulated/dcm> for the latest product information.

Vicor's Standard Terms and Conditions and Product Warranty

All sales are subject to Vicor's Standard Terms and Conditions of Sale, and Product Warranty which are available on Vicor's webpage (<https://www.vicorpower.com/termsconditionswarranty>) or upon request.

Life Support Policy

VICOR'S PRODUCTS ARE NOT AUTHORIZED FOR USE AS CRITICAL COMPONENTS IN LIFE SUPPORT DEVICES OR SYSTEMS WITHOUT THE EXPRESS PRIOR WRITTEN APPROVAL OF THE CHIEF EXECUTIVE OFFICER AND GENERAL COUNSEL OF VICOR CORPORATION. As used herein, life support devices or systems are devices which (a) are intended for surgical implant into the body, or (b) support or sustain life and whose failure to perform when properly used in accordance with instructions for use provided in the labeling can be reasonably expected to result in a significant injury to the user. A critical component is any component in a life support device or system whose failure to perform can be reasonably expected to cause the failure of the life support device or system or to affect its safety or effectiveness. Per Vicor Terms and Conditions of Sale, the user of Vicor products and components in life support applications assumes all risks of such use and indemnifies Vicor against all liability and damages.

Intellectual Property Notice

Vicor and its subsidiaries own Intellectual Property (including issued U.S. and Foreign Patents and pending patent applications) relating to the products described in this data sheet. No license, whether express, implied, or arising by estoppel or otherwise, to any intellectual property rights is granted by this document. Interested parties should contact Vicor's Intellectual Property Department.

The products described on this data sheet are protected by the following U.S. Patents Numbers:
RE40,072; 7,561,446; 7,920,391; 7,782,639; 8,427,269; 6,421,262; 9,516,761 and other patents pending.

Contact Us: <https://www.vicorpower.com/contact-us>

Vicor Corporation
25 Frontage Road
Andover, MA, USA 01810
Tel: 800-735-6200
Fax: 978-475-6715
www.vicorpower.com

email

Customer Service: custserv@vicorpower.co
Technical Support: apps@vicorpower.com