

YASMEEN-50-S-C-WHT

~15° spot beam. Assembly with holder C compatible with LEDiL HEKLA. White version.

SPECIFICATION:

| | |
|----------------|-----------|
| Dimensions | Ø 49.9 mm |
| Height | 28.1 mm |
| ROHS compliant | yes ⓘ |



MATERIALS:

| Component | Type | Material | Colour | Finish |
|----------------------|-------------|----------|--------|--------|
| YASMEEN-50-S | Single lens | PMMA | clear | |
| YASMEEN-50-HLD-C-WHT | Holder | PC | white | |





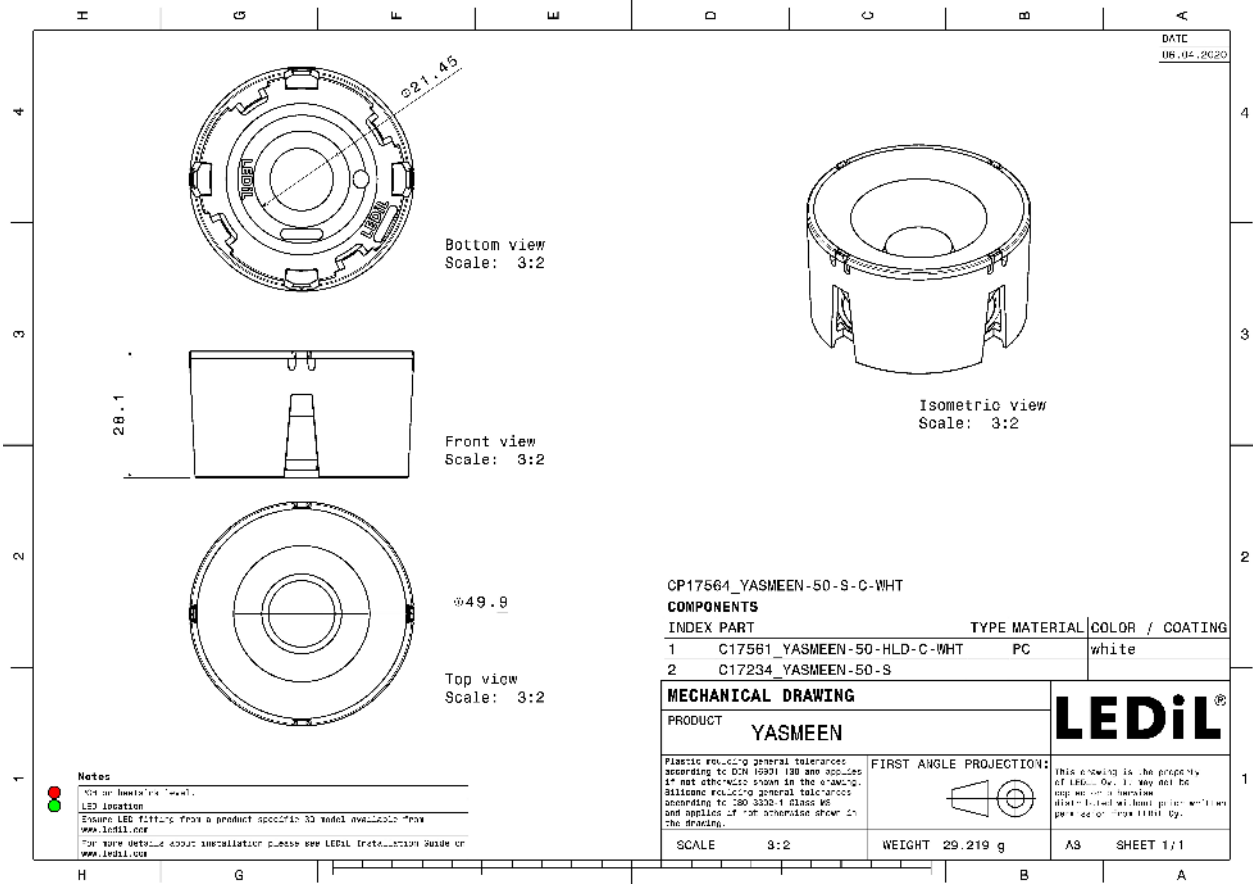



ORDERING INFORMATION:

| Component | Type | Qty in box | MOQ | MPQ | Box weight (kg) |
|--|-------------|------------|-----|-----|-----------------|
| CP17564_YASMEEN-50-S-C-WHT » Box size: 476 x 273 x 305 mm | Single lens | 252 | 112 | 28 | 8.9 |

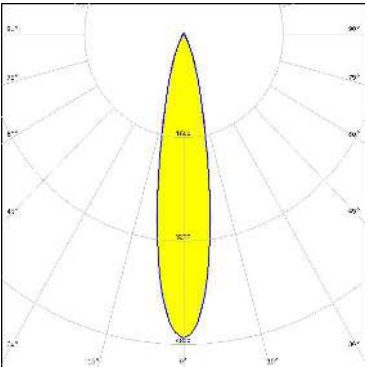

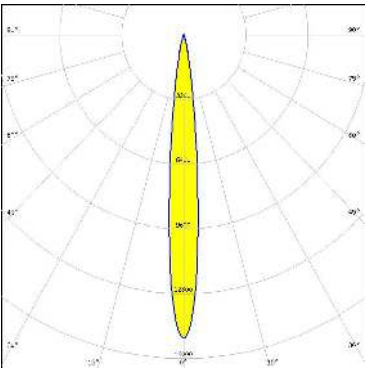

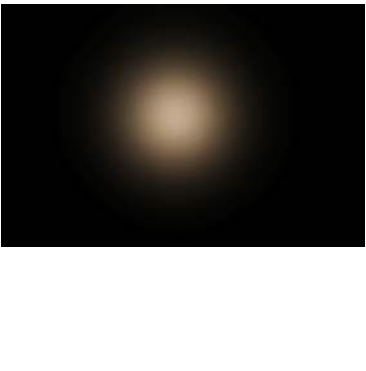
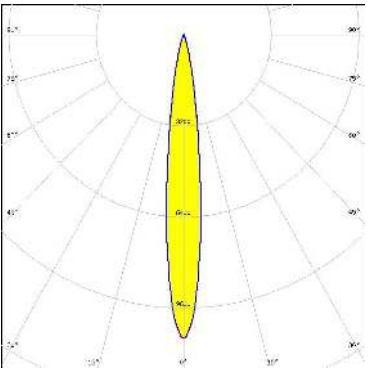

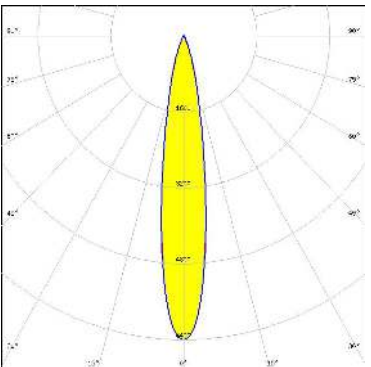

See also our general installation guide: www.ledil.com/installation_guide

OPTICAL RESULTS (MEASURED):

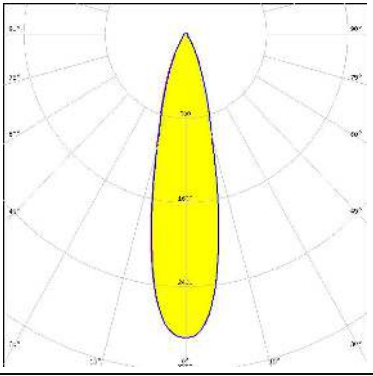
| | | |
|--|--|---|
| <p></p> <p>LED V11 HD Gen 8 FWHM / FWTM 20.0° / 43.0° Efficiency 93 % Peak intensity 4.7 cd/lm LEDs/each optic 1 Light colour White Required components: Bender Wirth: 633d Hekla</p> |  |  |
| <p></p> <p>LED V4 HD Gen 7 FWHM / FWTM 11.0° / 23.0° Efficiency 94 % Peak intensity 15 cd/lm LEDs/each optic 1 Light colour White Required components: F15253_HEKLA-SOCKET-A</p> |  |  |
| <p></p> <p>LED V6 HD Gen 7 FWHM / FWTM 13.0° / 28.0° Efficiency 94 % Peak intensity 10.7 cd/lm LEDs/each optic 1 Light colour White Required components: F15255_HEKLA-SOCKET-C</p> |  |  |
| <p></p> <p>LED VERO10 FWHM / FWTM 17.0° / 37.0° Efficiency 92 % Peak intensity 6.4 cd/lm LEDs/each optic 1 Light colour White Required components: F15616_HEKLA-SOCKET-F</p> |  |  |

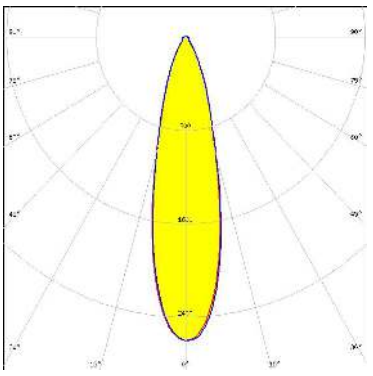
OPTICAL RESULTS (MEASURED):

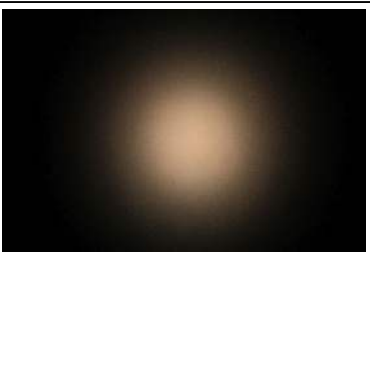
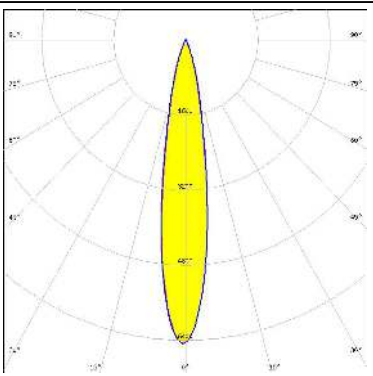
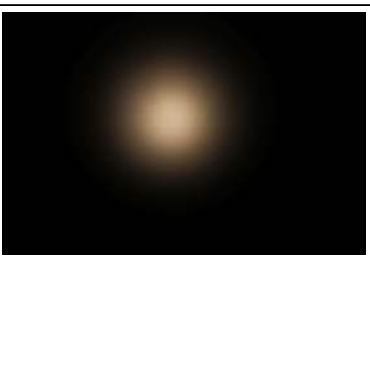
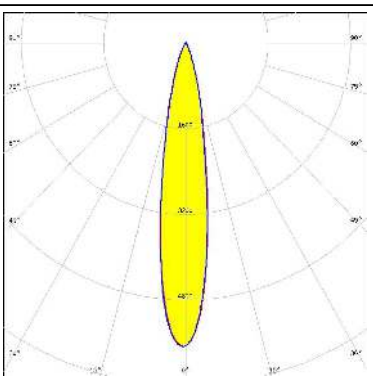
| | | |
|---|--|---|
| <p></p> <p>LED Vesta DTW 13mm (21W) FWHM / FWTM 25.0° / 53.0° Efficiency 89 % Peak intensity 2.9 cd/lm LEDs/each optic 1 Light colour White Required components: Bender Wirth: 632b Hekla XL</p> |  |  |
| <p></p> <p>LED Vesta DTW 15mm (33W) FWHM / FWTM 26.0° / 56.0° Efficiency 88 % Peak intensity 2.6 cd/lm LEDs/each optic 1 Light colour Tunable White Required components: Bender Wirth: 632b Hekla XL</p> |  |  |
| <p></p> <p>LED Vesta DTW 9mm (4W/6W/12W) FWHM / FWTM 18.0° / 37.0° Efficiency 93 % Peak intensity 6.5 cd/lm LEDs/each optic 1 Light colour White Required components: Bender Wirth: 652b Hekla</p> |  |  |
| <p>CITIZEN</p> <p>LED CLL02x/CLU02x (LES10) FWHM / FWTM 18.0° / 39.0° Efficiency 92 % Peak intensity 5.7 cd/lm LEDs/each optic 1 Light colour White Required components: F17435_HEKLA-G2-C</p> |  |  |

OPTICAL RESULTS (MEASURED):

CITIZEN

LED CLU700/701/702/703
 FWHM / FWTM 13.0° / 27.0°
 Efficiency 93 %
 Peak intensity 11 cd/lm
 LEDs/each optic 1
 Light colour White
 Required components:
 F17435_HEKLA-G2-C

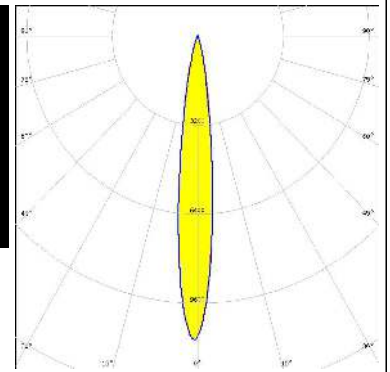

CITIZEN

LED CLU7A2/7A3
 FWHM / FWTM 11.0° / 23.0°
 Efficiency 94 %
 Peak intensity 15.1 cd/lm
 LEDs/each optic 1
 Light colour White
 Required components:
 F17435_HEKLA-G2-C

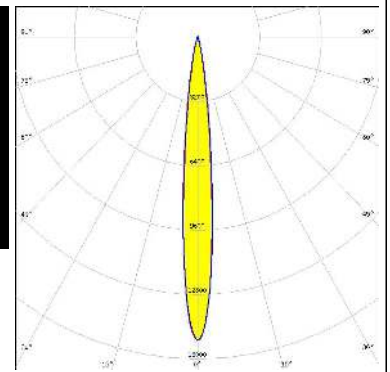

CITIZEN

LED CLU7B2
 FWHM / FWTM 10.0° / 21.0°
 Efficiency 94 %
 Peak intensity 17.8 cd/lm
 LEDs/each optic 1
 Light colour White
 Required components:
 F17435_HEKLA-G2-C

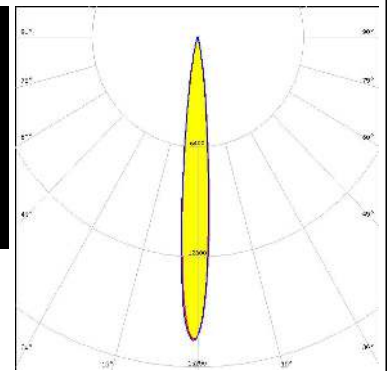
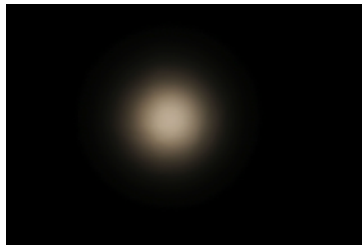

CREE LED

LED CMA1516
 FWHM / FWTM 17.0° / 37.0°
 Efficiency 93 %
 Peak intensity 6.2 cd/lm
 LEDs/each optic 1
 Light colour White
 Required components:
 F17436_HEKLA-G2-D

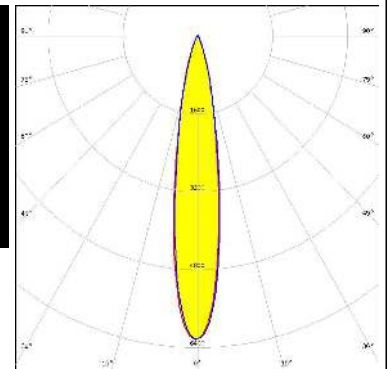

OPTICAL RESULTS (MEASURED):

CREE LED

LED CMT14xx
 FWHM / FWTM 18.0° / 38.0°
 Efficiency 92 %
 Peak intensity 5.8 cd/lm
 LEDs/each optic 1
 Light colour White
 Required components:
 F17435_HEKLA-G2-C

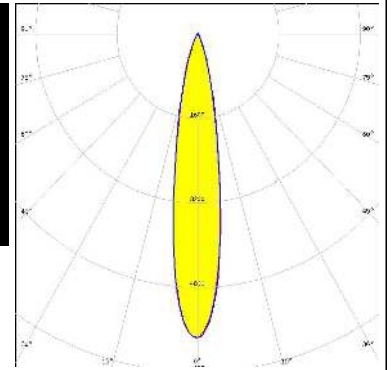

CREE LED

LED CXA/B 13xx
 FWHM / FWTM 12.0° / 26.0°
 Efficiency 94 %
 Peak intensity 12.5 cd/lm
 LEDs/each optic 1
 Light colour White
 Required components:
 F17439_HEKLA-G2-J

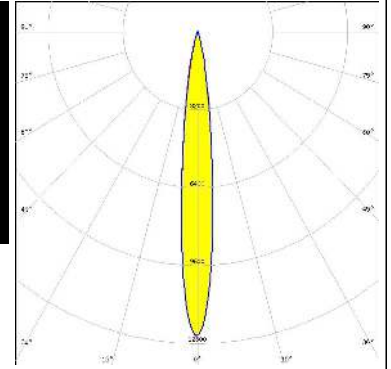

CREE LED

LED CXA/B 15xx
 FWHM / FWTM 16.0° / 34.0°
 Efficiency 93 %
 Peak intensity 7.3 cd/lm
 LEDs/each optic 1
 Light colour White
 Required components:
 F17436_HEKLA-G2-D

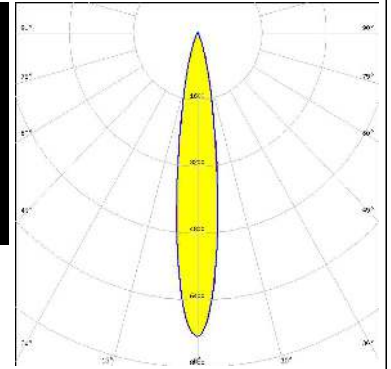





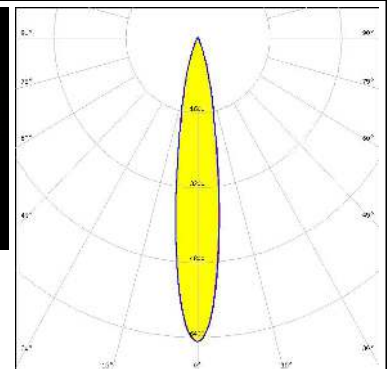
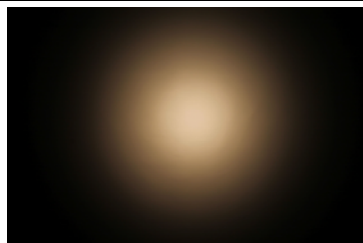

LUMILEDS

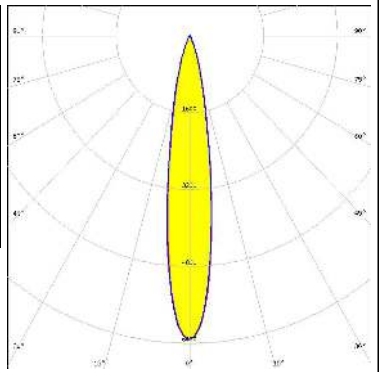
LED LUXEON CoB 1202/1203
 FWHM / FWTM 17.0° / 37.0°
 Efficiency 92 %
 Peak intensity 6.5 cd/lm
 LEDs/each optic 1
 Light colour White
 Required components:
 F17437_HEKLA-G2-H

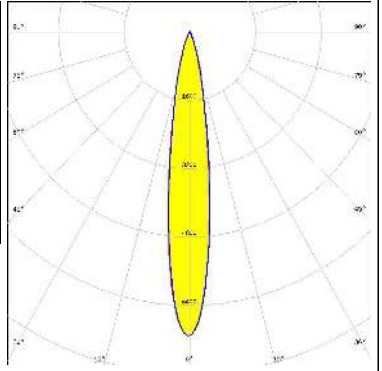

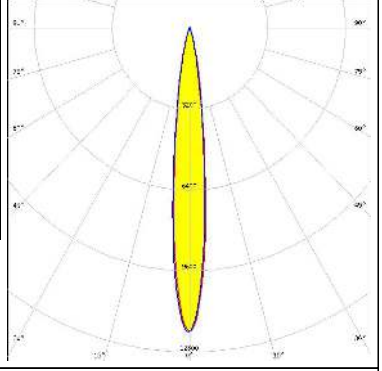
OPTICAL RESULTS (MEASURED):

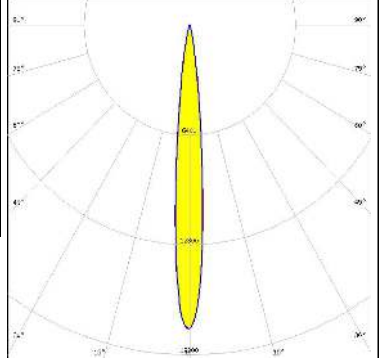
| | | |
|---|--|---|
| <p>LUMILEDS</p> <p>LED LUXEON CoB 1204HD</p> <p>FWHM / FWTM 17.0° / 37.0°</p> <p>Efficiency 93 %</p> <p>Peak intensity 6.3 cd/lm</p> <p>LEDs/each optic 1</p> <p>Light colour White</p> <p>Required components: F17437_HEKLA-G2-H</p> |  |  |
| <p>LUMILEDS</p> <p>LED LUXEON CoB M02/M03</p> <p>FWHM / FWTM 16.0° / 35.0°</p> <p>Efficiency 93 %</p> <p>Peak intensity 7.1 cd/lm</p> <p>LEDs/each optic 1</p> <p>Light colour White</p> <p>Required components: F17436_HEKLA-G2-D</p> |  |  |
| <p>LUMILEDS</p> <p>LED LUXEON CoB S01</p> <p>FWHM / FWTM 12.0° / 26.0°</p> <p>Efficiency 94 %</p> <p>Peak intensity 12 cd/lm</p> <p>LEDs/each optic 1</p> <p>Light colour White</p> <p>Required components: F17439_HEKLA-G2-J</p> |  |  |
| <p>LUMINUS</p> <p>LED CXM-3</p> <p>FWHM / FWTM 10.0° / 21.0°</p> <p>Efficiency 94 %</p> <p>Peak intensity 17.7 cd/lm</p> <p>LEDs/each optic 1</p> <p>Light colour White</p> <p>Required components: F17435_HEKLA-G2-C</p> |  |  |

OPTICAL RESULTS (MEASURED):



LED CXM-4
 FWHM / FWTM 11.0° / 24.0°
 Efficiency 94 %
 Peak intensity 14.4 cd/lm
 LEDs/each optic 1
 Light colour White
 Required components:
 F17435_HEKLA-G2-C

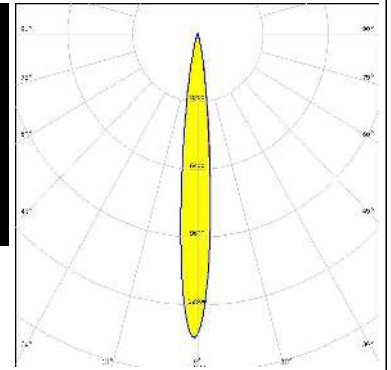
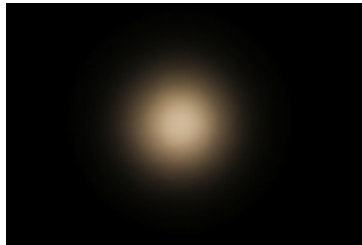

LED COB L-Type (LES 9)
 FWHM / FWTM 16.0° / 35.0°
 Efficiency 92 %
 Peak intensity 7 cd/lm
 LEDs/each optic 1
 Light colour White
 Required components:
 F17437_HEKLA-G2-H

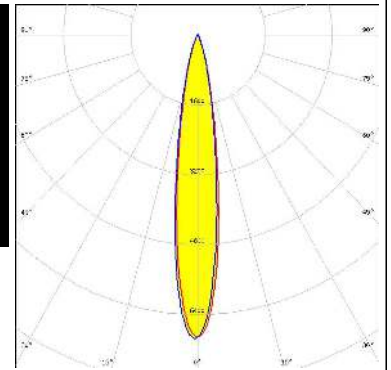

LED COB S-Type (LES 7)
 FWHM / FWTM 14.0° / 29.0°
 Efficiency 93 %
 Peak intensity 10.1 cd/lm
 LEDs/each optic 1
 Light colour White
 Required components:
 F15848_HEKLA-SOCKET-G

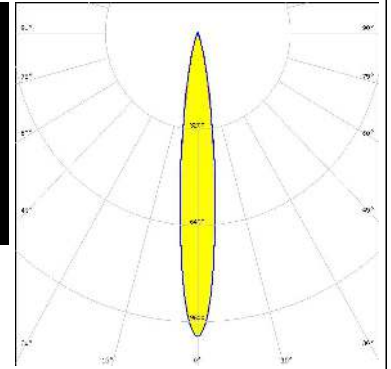

LED Fortimo SLM L09 CoB
 FWHM / FWTM 17.0° / 37.0°
 Efficiency 92 %
 Peak intensity 6.4 cd/lm
 LEDs/each optic 1
 Light colour White
 Required components:
 F17437_HEKLA-G2-H

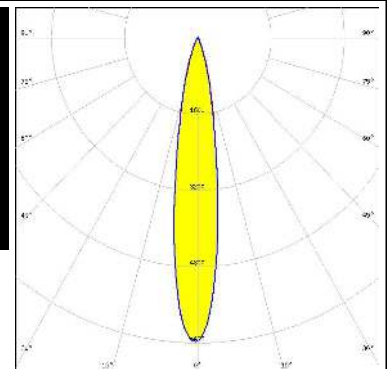

OPTICAL RESULTS (MEASURED):

SAMSUNG

LED LC003D / LC006D / LC009D / LC013D
 FWHM / FWTM 17.0° / 38.0°
 Efficiency 92 %
 Peak intensity 5.8 cd/lm
 LEDs/each optic 1
 Light colour White
 Required components:
 F17435_HEKLA-G2-C

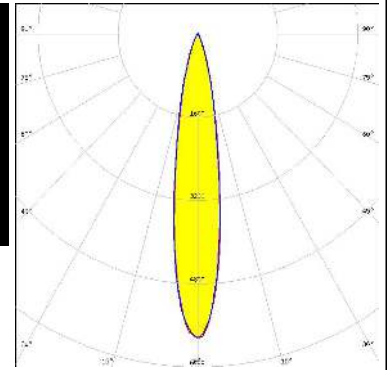
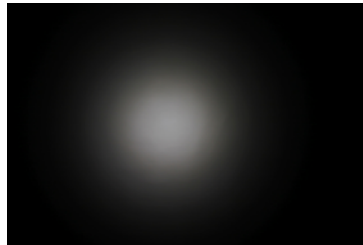

SEOUL SEMICONDUCTOR
 LED MJT COB LES 6
 FWHM / FWTM 12.0° / 27.0°
 Efficiency 94 %
 Peak intensity 11.7 cd/lm
 LEDs/each optic 1
 Light colour White
 Required components:
 F17435_HEKLA-G2-C

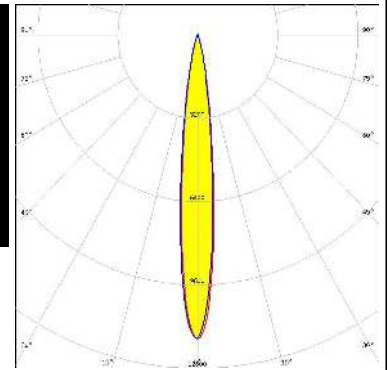
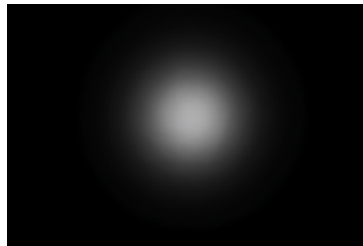

SEOUL SEMICONDUCTOR
 LED MJT COB LES 9.8
 FWHM / FWTM 18.0° / 39.0°
 Efficiency 92 %
 Peak intensity 5.7 cd/lm
 LEDs/each optic 1
 Light colour White
 Required components:
 F17435_HEKLA-G2-C

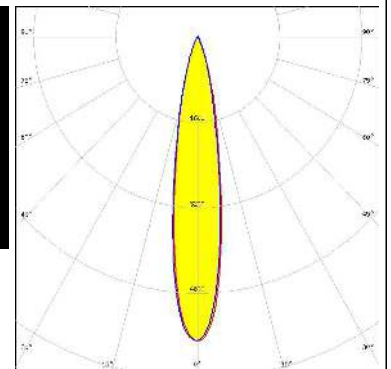
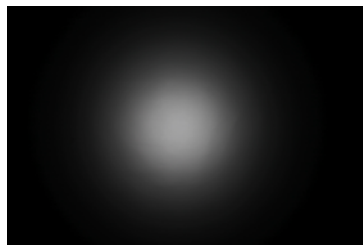

TRIDONIC

LED SLE G7 LES09
 FWHM / FWTM 17.0° / 36.0°
 Efficiency 93 %
 Peak intensity 6.6 cd/lm
 LEDs/each optic 1
 Light colour White
 Required components:
 F17435_HEKLA-G2-C

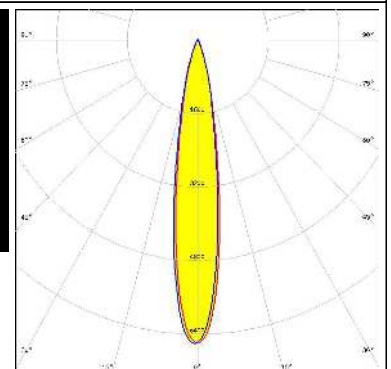

GENERAL INFORMATION:

NOTE: The typical beam angle will be changed by different color, chip size and chip position tolerance. The typical total beam angle is the full angle measured where the luminous intensity is half of the peak value.

Due to use of high power COB's with this product, special attention to proper thermal design is highly recommended. LEDiL has no liability for direct, indirect or consecutive damages arising from the LEDiL products being used outside of the recommended temperature range.

MATERIALS:

As part of our continuous research and improvement processes, and to ensure the best possible quality and availability of our products, LEDiL reserves the right to change material grades without notice.

PRODUCT DATA USER AGREEMENT AND DISCLAIMER:

The measured data in the provided downloadable LEDiL Product Datasheets and Mechanical 2D-Drawings is rounded and provided as reference for planning. LEDiL Oy's optical specifications have been verified by conducting performance testing of the products in accordance with the company's quality system. The reported data are averaged results of multiple measurements with typical variation. LEDiL Oy reserves the right to without prior notification make changes and improvements to its products.

LEDiL Oy assumes neither warranty, nor guarantee nor any other liability of any kind for the contents and correctness of the provided data. The provided data has been generated with highest diligence but the provided data may in reality not represent the complete possible variation range of all intrinsic parameters. Therefore, in certain cases a deviation from the provided data could occur.

LEDiL Oy reserves the right to undertake technical changes of its products without further notification which could lead to changes in the provided data. LEDiL Oy assumes no liability of any kind for the possible deviation from any provided data or any other damage resulting from the usage of the provided data.

The user agrees to this disclaimer and user agreement with the download or usage of the provided files.

LEDiL Oy

Joensuunkatu 13
FI-24240 SALO
Finland

LEDiL Inc.

228 West Page Street
Suite D
Sycamore IL 60178
USA

Ledil Optics Technology (Shenzhen) Co., Ltd.

405 , Block B
Casic Motor Building
Shenzhen 518057
P.R.CHINA

Local sales and technical support

[www.ledil.com/
where_to_buy](http://www.ledil.com/where_to_buy)

Shipping locations

Salo, Finland
Hong Kong, China

Distribution Partners

[www.ledil.com/
where_to_buy](http://www.ledil.com/where_to_buy)