

TLE2027-Q1, TLE2037-Q1, TLE2027A-Q1, TLE2037A-Q1 EXCALIBUR LOW-NOISE HIGH-SPEED PRECISION OPERATIONAL AMPLIFIERS

SGLS202B – OCTOBER 2003 – REVISED APRIL 2008

- Qualified for Automotive Applications
- ESD Protection Exceeds 2000 V Per MIL-STD-883, Method 3015; Exceeds 200 V Using Machine Model (C = 200 pF, R = 0)
- Outstanding Combination of DC Precision and AC Performance:
- Available in Standard-Pinout Small-Outline Package
- Output Features Saturation Recovery Circuitry
- Macromodels and Statistical information

Unity-Gain Bandwidth . . . 15 MHz Typ
 V_n 3.3 nV/ $\sqrt{\text{Hz}}$ at $f = 10$ Hz Typ,
 2.5 nV/ $\sqrt{\text{Hz}}$ at $f = 1$ kHz Typ
 V_{IO} 25 μV Max
 A_{VD} . . . 45 V/ μV Typ With $R_L = 2$ k Ω ,
 19 V/ μV Typ With $R_L = 600$ Ω

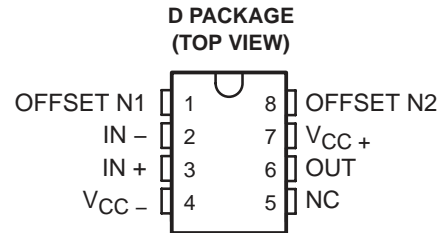

description

The TLE20x7 and TLE20x7A contain innovative circuit design expertise and high-quality process control techniques to produce a level of ac performance and dc precision previously unavailable in single operational amplifiers. Manufactured using Texas Instruments state-of-the-art Excalibur process, these devices allow upgrades to systems that use lower-precision devices.

In the area of dc precision, the TLE20x7 and TLE20x7A offer maximum offset voltages of 100 μV and 25 μV , respectively, common-mode rejection ratio of 131 dB (typ), supply voltage rejection ratio of 144 dB (typ), and dc gain of 45 V/ μV (typ).

The ac performance of the TLE2027 and TLE2037 is highlighted by a typical unity-gain bandwidth specification of 15 MHz, 55° of phase margin, and noise voltage specifications of 3.3 nV/ $\sqrt{\text{Hz}}$ and 2.5 nV/ $\sqrt{\text{Hz}}$ at frequencies of 10 Hz and 1 kHz, respectively. The TLE2037 and TLE2037A have been decompensated for faster slew rate (–7.5 V/ μs , typical) and wider bandwidth (50 MHz). To ensure stability, the TLE2037 and TLE2037A should be operated with a closed-loop gain of 5 or greater.

ORDERING INFORMATION†

T_A	$V_{IO\text{max}}$ AT 25°C	PACKAGE‡		ORDERABLE PART NUMBER	TOP-SIDE MARKING
–40°C to 125°C	25 μV	SOIC (D)	Tape and reel	TLE2027AQDRQ1	2027AQ
				TLE2037AQDRQ1	2037AQ
	100 μV	SOIC (D)	Tape and reel	TLE2027QDRQ1	2027Q1
				TLE2037QDRQ1	2037Q1

† For the most current package and ordering information, see the Package Option Addendum at the end of this document, or see the TI web site at <http://www.ti.com>.

‡ Package drawings, thermal data, and symbolization are available at <http://www.ti.com/packaging>.



Please be aware that an important notice concerning availability, standard warranty, and use in critical applications of Texas Instruments semiconductor products and disclaimers thereto appears at the end of this data sheet.

PRODUCTION DATA information is current as of publication date. Products conform to specifications per the terms of Texas Instruments standard warranty. Production processing does not necessarily include testing of all parameters.

 **TEXAS
INSTRUMENTS**

POST OFFICE BOX 655303 • DALLAS, TEXAS 75265

Copyright © 2008 Texas Instruments Incorporated

TLE2027-Q1, TLE2037-Q1, TLE2027A-Q1, TLE2037A-Q1 EXCALIBUR LOW-NOISE HIGH-SPEED PRECISION OPERATIONAL AMPLIFIERS

SGLS202B – OCTOBER 2003 – REVISED APRIL 2008

description (continued)

Both the TLE20x7 and TLE20x7A are available in a wide variety of packages, including the industry-standard 8-pin small-outline version for high-density system applications. The Q-suffix devices are characterized for operation from -40°C to 125°C .

symbol

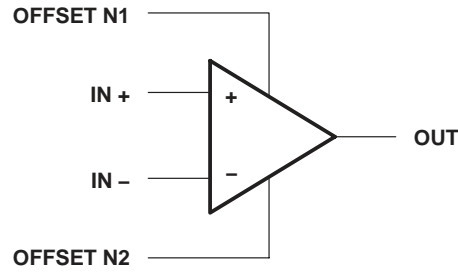

TLE2027-Q1, TLE2037-Q1, TLE2027A-Q1, TLE2037A-Q1 EXCALIBUR LOW-NOISE HIGH-SPEED PRECISION OPERATIONAL AMPLIFIERS

SGLS202A – OCTOBER 2003 – REVISED OCTOBER 2006

equivalent schematic

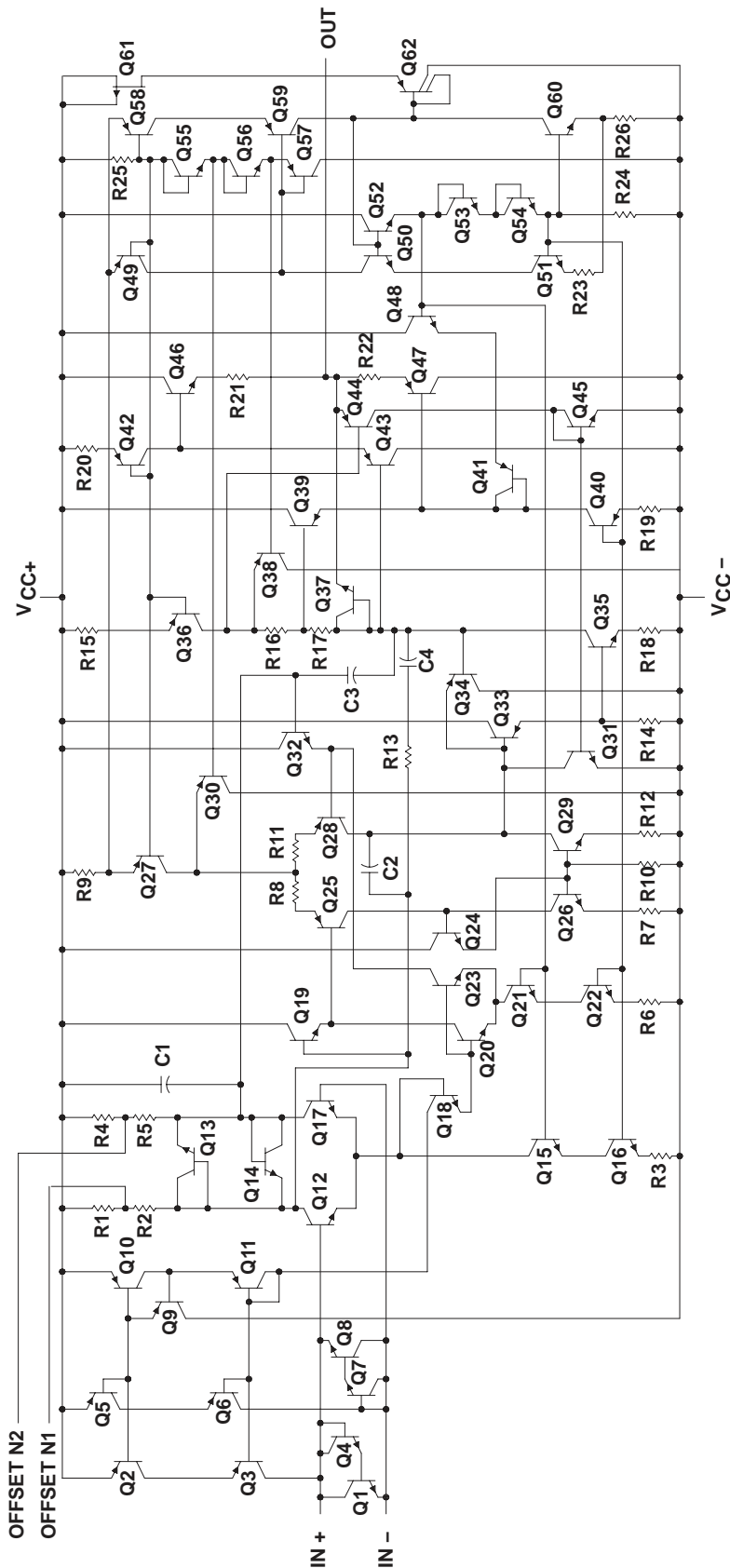

ACTUAL DEVICE COMPONENT COUNT		
COMPONENT	TLE2027	TLE2037
Transistors	61	61
Resistors	26	26
epiFET	1	1
Capacitors	4	4

TLE2027-Q1, TLE2037-Q1, TLE2027A-Q1, TLE2037A-Q1 EXCALIBUR LOW-NOISE HIGH-SPEED PRECISION OPERATIONAL AMPLIFIERS

SGLS202A – OCTOBER 2003 – REVISED OCTOBER 2006

absolute maximum ratings over operating free-air temperature range (unless otherwise noted)[†]

Supply voltage, V_{CC+} (see Note 1)	19 V
Supply voltage, V_{CC-}	-19 V
Differential input voltage, V_{ID} (see Note 2)	± 1.2 V
Input voltage range, V_I (any input)	$V_{CC\pm}$
Input current, I_I (each Input)	± 1 mA
Output current, I_O	± 50 mA
Total current into V_{CC+}	50 mA
Total current out of V_{CC-}	50 mA
Duration of short-circuit current at (or below) 25°C (see Note 3)	Unlimited
Junction temperature, T_J	142°C
Operating free-air temperature range, T_A : Q suffix	-40°C to 125°C
Storage temperature range, T_{stg}	-65°C to 150°C
Package thermal impedance, θ_{JA} (D Package) (0 LFPM) (see Note 4)	101°C/W
Lead temperature 1,6 mm (1/16 inch) from case for 10 seconds: D package	260°C

[†] Stresses beyond those listed under “absolute maximum ratings” may cause permanent damage to the device. These are stress ratings only, and functional operation of the device at these or any other conditions beyond those indicated under “recommended operating conditions” is not implied. Exposure to absolute-maximum-rated conditions for extended periods may affect device reliability.

- NOTES:
1. All voltage values, except differential voltages, are with respect to the midpoint between V_{CC+} and V_{CC-} .
 2. Differential voltages are at $IN+$ with respect to $IN-$. Excessive current flows if a differential input voltage in excess of approximately ± 1.2 V is applied between the inputs, unless some limiting resistance is used.
 3. The output may be shorted to either supply. Temperature and/or supply voltages must be limited to ensure that the maximum dissipation rating is not exceeded.
 4. The thermal impedance is calculated in accordance with JESD 51-7.

recommended operating conditions

		MIN	MAX	UNIT
Supply voltage, $V_{CC\pm}$		± 4	± 19	V
Common-mode input voltage, V_{IC}	$T_A = 25^\circ\text{C}$	-11	11	V
	$T_A = \text{Full range}^\ddagger$	-10.2	10.2	
Operating free-air temperature, T_A		-40	125	°C

[‡] Full range is -40°C to 125°C for Q-suffix devices.



TLE2027-Q1, TLE2037-Q1, TLE2027A-Q1, TLE2037A-Q1
EXCALIBUR LOW-NOISE HIGH-SPEED
PRECISION OPERATIONAL AMPLIFIERS

SGLS202A – OCTOBER 2003 – REVISED OCTOBER 2006

TLE20x7-Q1 electrical characteristics at specified free-air temperature, $V_{CC\pm} = \pm 15\text{ V}$ (unless otherwise noted)

PARAMETER	TEST CONDITIONS	T_A^\dagger	TLE20x7-Q1			TLE20x7A-Q1			UNIT
			MIN	TYP	MAX	MIN	TYP	MAX	
V_{IO} Input offset voltage		25°C	20	100		10	25	μV	
		Full range		200		105			
α_{VIO} Temperature coefficient of input offset voltage		Full range	0.4	1		0.2	1	$\mu\text{V}/^\circ\text{C}$	
Input offset voltage long-term drift (see Note 4)	$V_{IC} = 0, R_S = 50\ \Omega$	25°C	0.006	1		0.006	1	$\mu\text{V}/\text{mo}$	
I_{IO} Input offset current		25°C	6	90		6	90	nA	
		Full range		150		150			
I_{IB} Input bias current		25°C	15	90		15	90	nA	
		Full range		150		150			
V_{ICR} Common-mode input voltage range		$R_S = 50\ \Omega$	25°C	-11 to 11	-13 to 13		-11 to 11	-13 to 13	V
	Full range		-10.3 to 10.3			-10.4 to 10.4			
V_{OM+} Maximum positive peak output voltage swing	$R_L = 600\ \Omega$	25°C	10.5	12.9		10.5	12.9	V	
		Full range	10			10			
	$R_L = 2\ \text{k}\Omega$	25°C	12	13.2		12	13.2		
		Full range	11			11			
V_{OM-} Maximum negative peak output voltage swing	$R_L = 600\ \Omega$	25°C	-10.5	-13		-10.5	-13	V	
		Full range	-10			-10			
	$R_L = 2\ \text{k}\Omega$	25°C	-12	-13.5		-12	-13.5		
		Full range	-11			-11			
A_{VD} Large-signal differential voltage amplification	$V_O = \pm 11\ \text{V}, R_L = 2\ \text{k}\Omega$	25°C	5	45		10	45	V/ μV	
	$V_O = \pm 10\ \text{V}, R_L = 2\ \text{k}\Omega$	Full range	2.5			3.5			
	$V_O = \pm 10\ \text{V}, R_L = 1\ \text{k}\Omega$	25°C	3.5	38		8	38		
		Full range	1.8			2.2			
	$V_O = \pm 10\ \text{V}, R_L = 600\ \Omega$	25°C	2	19		5	19		
C_i Input capacitance		25°C	8			8	pF		
z_o Open-loop output impedance	$I_O = 0$	25°C	50			50	Ω		
CMRR Common-mode rejection ratio	$V_{IC} = V_{ICRmin}, R_S = 50\ \Omega$	25°C	100	131		117	131	dB	
		Full range	96			113			
k_{SVR} Supply-voltage rejection ratio ($\Delta V_{CC\pm} / \Delta V_{IO}$)	$V_{CC\pm} = \pm 4\ \text{V to } \pm 18\ \text{V}, R_S = 50\ \Omega$	25°C	94	144		110	144	dB	
	$V_{CC\pm} = \pm 4\ \text{V to } \pm 18\ \text{V}, R_S = 50\ \Omega$	Full range	90			105			
I_{CC} Supply current	$V_O = 0, \text{ No load}$	25°C	3.8	5.3		3.8	5.3	mA	
		Full range		5.6			5.6		

† Full range is -40°C to 125°C .

NOTE 4: Typical values are based on the input offset voltage shift observed through 168 hours of operating life test at $T_A = 150^\circ\text{C}$ extrapolated to $T_A = 25^\circ\text{C}$ using the Arrhenius equation and assuming an activation energy of 0.96 eV.



TLE2027-Q1, TLE2037-Q1, TLE2027A-Q1, TLE2037A-Q1
EXCALIBUR LOW-NOISE HIGH-SPEED
PRECISION OPERATIONAL AMPLIFIERS

SGLS202A – OCTOBER 2003 – REVISED OCTOBER 2006

TLE20x7-Q1 operating characteristics at specified free-air temperature, $V_{CC \pm} = \pm 15\text{ V}$, $T_A = 25^\circ\text{C}$ (unless otherwise specified)

PARAMETER	TEST CONDITIONS		TLE20x7-Q1			TLE20x7A-Q1			UNIT
			MIN	TYP	MAX	MIN	TYP	MAX	
SR	Slew rate at unity gain	$R_L = 2\text{ k}\Omega$, $C_L = 100\text{ pF}$, See Figure 1	TLE2027	1.7	2.8		1.7	2.8	V/ μs
			TLE2037	6	7.5		6	7.5	
	$R_L = 2\text{ k}\Omega$, $C_L = 100\text{ pF}$, $T_A = -55^\circ\text{C}$ to 125°C , See Figure 1	TLE2027	1			1			
		TLE2037	4.4			4.4			
V_n	Equivalent input noise voltage (see Figure 2)	$R_S = 20\ \Omega$, $f = 10\text{ Hz}$		3.3	8		3.3	4.5	nV/ $\sqrt{\text{Hz}}$
			$R_S = 20\ \Omega$, $f = 1\text{ kHz}$		2.5	4.5		2.5	
$V_{N(PP)}$	Peak-to-peak equivalent input noise voltage	$f = 0.1\text{ Hz}$ to 10 Hz		50	250		50	130	nV
I_n	Equivalent input noise current	$f = 10\text{ Hz}$		10			10		pA/ $\sqrt{\text{Hz}}$
		$f = 1\text{ kHz}$		0.8			0.8		
THD	Total harmonic distortion	$V_O = +10\text{ V}$, $A_{VD} = 1$, See Note 5	TLE2027	<0.002			<0.002		%
		$V_O = +10\text{ V}$, $A_{VD} = 5$, See Note 5	TLE2037	<0.002			<0.002		
B_1	Unity-gain bandwidth (see Figure 3)	$R_L = 2\text{ k}\Omega$, $C_L = 100\text{ pF}$	TLE2027	7	13		9	13	MHz
			TLE2037	35	50		35	50	
B_{OM}	Maximum output-swing bandwidth	$R_L = 2\text{ k}\Omega$	TLE2027	30			30		kHz
			TLE2037	80			80		
ϕ_m	Phase margin at unity gain (see Figure 3)	$R_L = 2\text{ k}\Omega$, $C_L = 100\text{ pF}$	TLE2027	55			55		°
			TLE2037	50			50		

NOTE 5: Measured distortion of the source used in the analysis was 0.002%.



PARAMETER MEASUREMENT INFORMATION

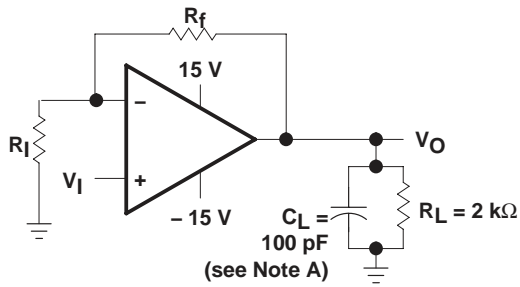

NOTE A: C_L includes fixture capacitance.

Figure 1. Slew-Rate Test Circuit

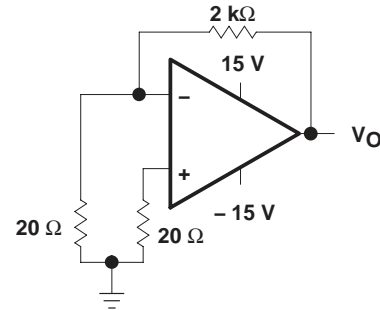
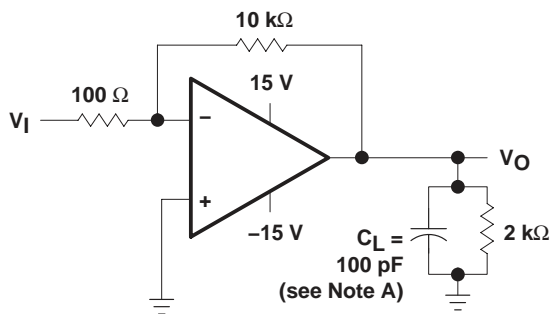
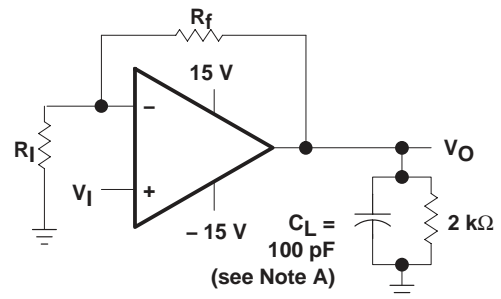

Figure 2. Noise-Voltage Test Circuit



NOTE A: C_L includes fixture capacitance.

Figure 3. Unity-Gain Bandwidth and Phase-Margin Test Circuit (TLE2027 Only)



NOTES: A. C_L includes fixture capacitance.
 B. For the TLE2037 and TLE2037A, A_{VD} must be ≥ 5 .

Figure 4. Small-Signal Pulse-Response Test Circuit

TLE2027-Q1, TLE2037-Q1, TLE2027A-Q1, TLE2037A-Q1 EXCALIBUR LOW-NOISE HIGH-SPEED PRECISION OPERATIONAL AMPLIFIERS

SGLS202A – OCTOBER 2003 – REVISED OCTOBER 2006

typical values

Typical values presented in this data sheet represent the median (50% point) of device parametric performance.

initial estimates of parameter distributions

In the ongoing program of improving data sheets and supplying more information to our customers, Texas Instruments has added an estimate of not only the typical values, but also the spread around these values. These are in the form of distribution bars that show the 95% (upper) points and the 5% (lower) points from the characterization of the initial wafer lots of this new device type (see Figure 5). The distribution bars are shown at the points where data was actually collected. The 95% and 5% points are used instead of ± 3 sigma, since some of the distributions are not true Gaussian distributions.

The number of units tested and the number of different wafer lots used are on all of the graphs where distribution bars are shown. As noted in Figure 5, there were a total of 835 units from two wafer lots. In this case, there is a good estimate for the within-lot variability and a possibly poor estimate of the lot-to-lot variability. This is always the case on newly released products, since there can only be data available from a few wafer lots.

The distribution bars are not intended to replace the minimum and maximum limits in the electrical tables. Each distribution bar represents 90% of the total units tested at a specific temperature. While 10% of the units tested fell outside any given distribution bar, this should not be interpreted to mean that the same individual devices fell outside every distribution bar.

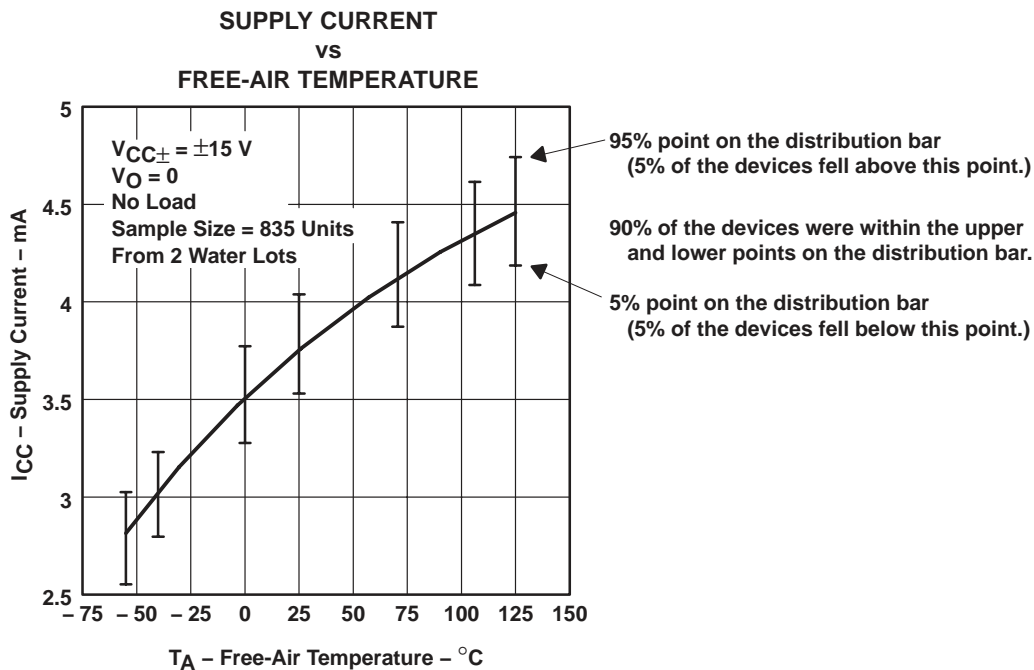

Figure 5. Sample Graph With Distribution Bars

TLE2027-Q1, TLE2037-Q1, TLE2027A-Q1, TLE2037A-Q1
EXCALIBUR LOW-NOISE HIGH-SPEED
PRECISION OPERATIONAL AMPLIFIERS

SGLS202A – OCTOBER 2003 – REVISED OCTOBER 2006

TYPICAL CHARACTERISTICS

Table of Graphs

		FIGURE	
V_{IO}	Input offset voltage	Distribution	6, 7
ΔV_{IO}	Input offset voltage change	vs Time after power on	8, 9
I_{IO}	Input offset current	vs Free-air temperature	10
I_{IB}	Input bias current	vs Free-air temperature	11
		vs Common-mode input voltage	12
I_I	Input current	vs Differential input voltage	13
$V_{O(PP)}$	Maximum peak-to-peak output voltage	vs Frequency	14, 15
V_{OM}	Maximum (positive/negative) peak output voltage	vs Load resistance	16, 17
		vs Free-air temperature	18, 19
A_{VD}	Large-signal differential voltage amplification	vs Supply voltage	20
		vs Load resistance	21
		vs Frequency	22 – 25
		vs Free-air temperature	26
z_o	Output impedance	vs Frequency	27
CMRR	Common-mode rejection ratio	vs Frequency	28
k_{SVR}	Supply-voltage rejection ratio	vs Frequency	29
I_{OS}	Short-circuit output current	vs Supply voltage	30, 31
		vs Elapsed time	32, 33
		vs Free-air temperature	34, 35
I_{CC}	Supply current	vs Supply voltage	36
		vs Free-air temperature	37
	Voltage-follower pulse response	Small signal	38, 40
		Large signal	39, 41
V_n	Equivalent input noise voltage	vs Frequency	42
	Noise voltage (referred to input)	Over 10-second interval	43
B_1	Unity-gain bandwidth	vs Supply voltage	44
		vs Load capacitance	45
	Gain bandwidth product	vs Supply voltage	46
		vs Load capacitance	47
SR	Slew rate	vs Free-air temperature	48, 49
ϕ_m	Phase margin	vs Supply voltage	50, 51
		vs Load capacitance	52, 53
		vs Free-air temperature	54, 55
	Phase shift	vs Frequency	22 – 25

TLE2027-Q1, TLE2037-Q1, TLE2027A-Q1, TLE2037A-Q1
EXCALIBUR LOW-NOISE HIGH-SPEED
PRECISION OPERATIONAL AMPLIFIERS

SGLS202A – OCTOBER 2003 – REVISED OCTOBER 2006

TYPICAL CHARACTERISTICS

**DISTRIBUTION
INPUT OFFSET VOLTAGE**

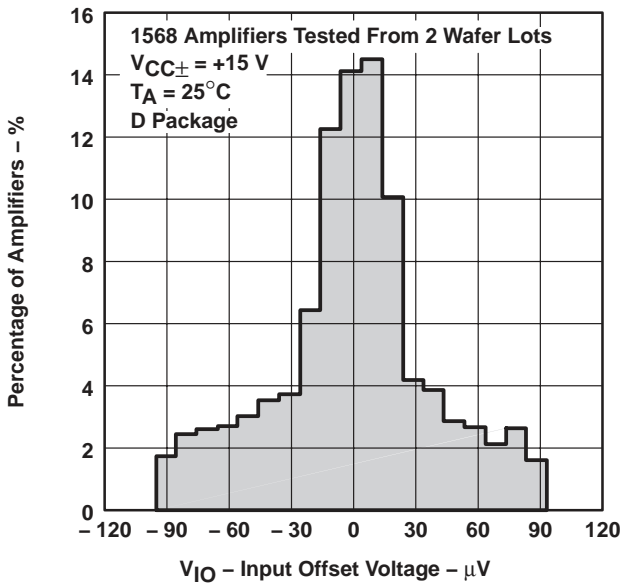

Figure 6

**INPUT OFFSET VOLTAGE CHANGE
vs
TIME AFTER POWER ON**

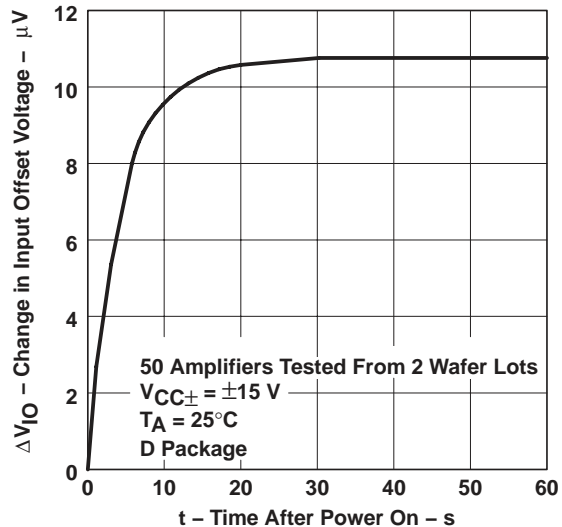

Figure 7

**INPUT OFFSET VOLTAGE CHANGE
vs
TIME AFTER POWER ON**

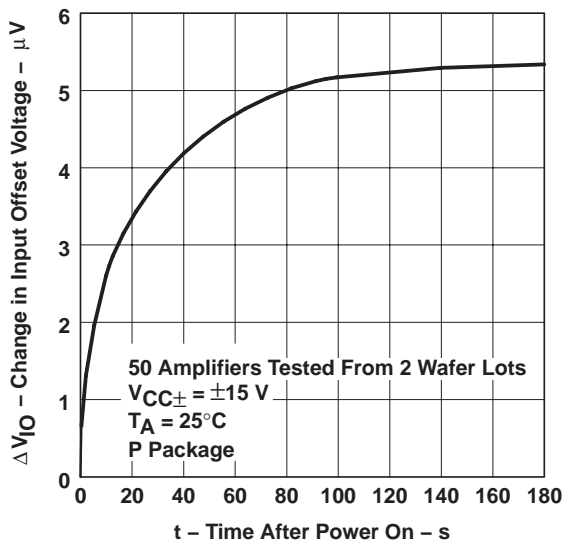

Figure 8

**INPUT OFFSET CURRENT†
vs
FREE-AIR TEMPERATURE**

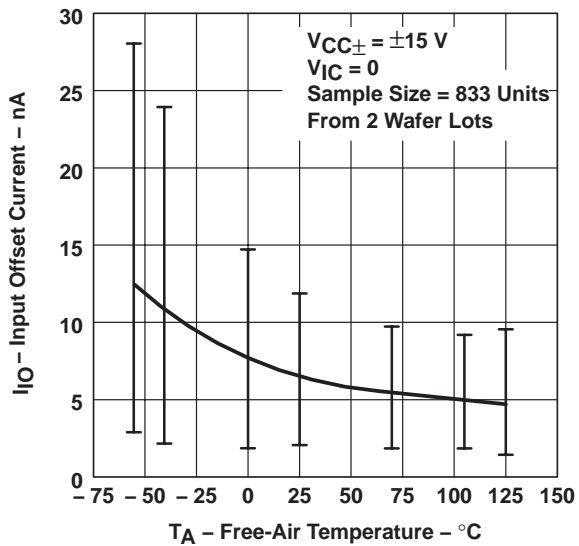

Figure 9

† Data at high and low temperatures are applicable only within the rated operating free-air temperature ranges of the various devices.

TYPICAL CHARACTERISTICS

**INPUT BIAS CURRENT †
 vs
 FREE-AIR TEMPERATURE**

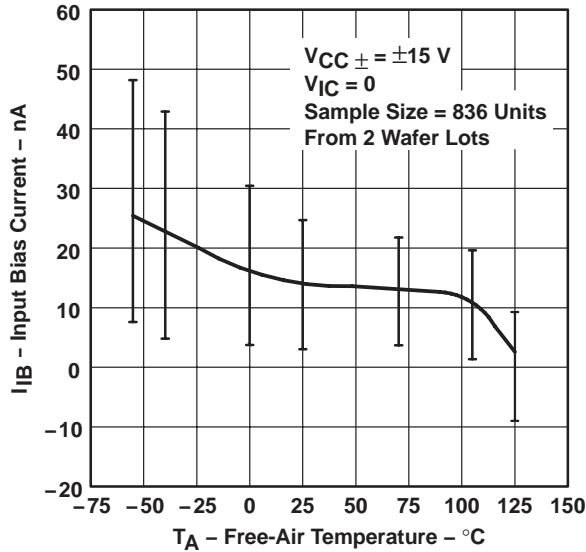

Figure 10

**INPUT BIAS CURRENT
 vs
 COMMON-MODE INPUT VOLTAGE**

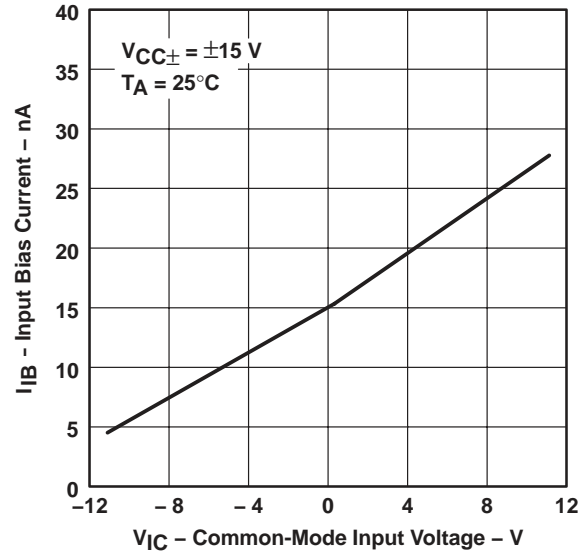

Figure 11

**INPUT CURRENT
 vs
 DIFFERENTIAL INPUT VOLTAGE**

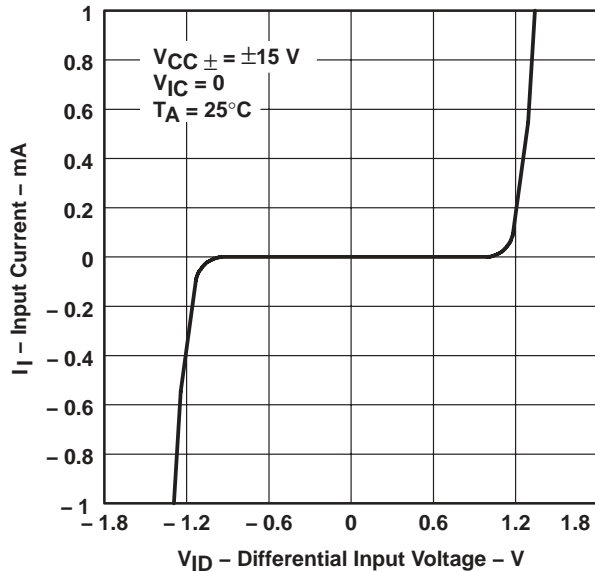

Figure 12

**TLE2027
 MAXIMUM PEAK-TO-PEAK
 OUTPUT VOLTAGE †
 vs
 FREQUENCY**

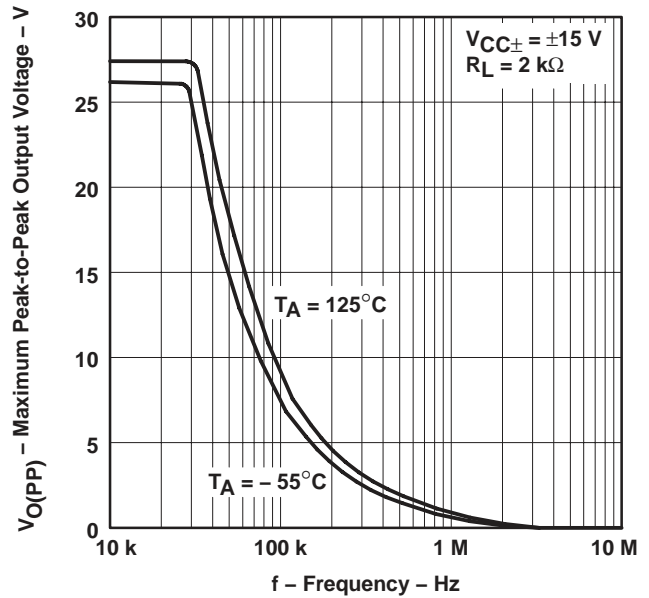

Figure 13

† Data at high and low temperatures are applicable only within the rated operating free-air temperature ranges of the various devices.

TLE2027-Q1, TLE2037-Q1, TLE2027A-Q1, TLE2037A-Q1
EXCALIBUR LOW-NOISE HIGH-SPEED
PRECISION OPERATIONAL AMPLIFIERS

SGLS202A – OCTOBER 2003 – REVISED OCTOBER 2006

TYPICAL CHARACTERISTICS

TLE2037
MAXIMUM PEAK-TO-PEAK
OUTPUT VOLTAGE†
vs
FREQUENCY

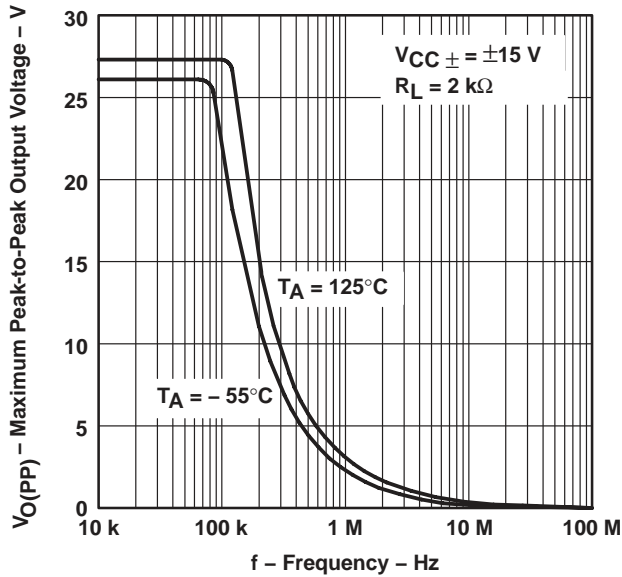

Figure 14

MAXIMUM POSITIVE PEAK
OUTPUT VOLTAGE
vs
LOAD RESISTANCE

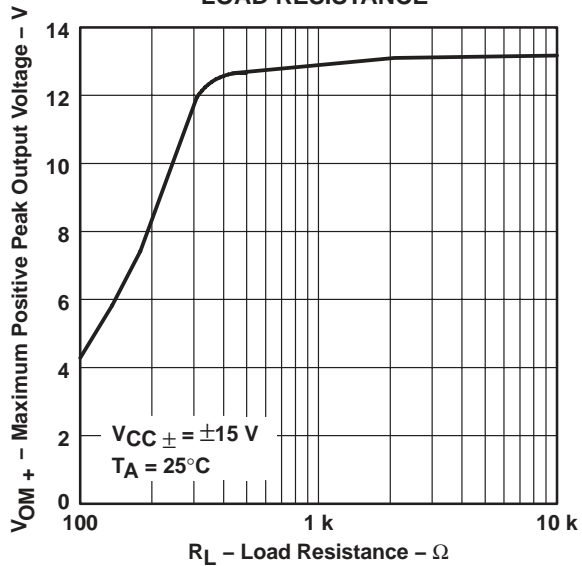

Figure 15

MAXIMUM NEGATIVE PEAK
OUTPUT VOLTAGE
vs
LOAD RESISTANCE

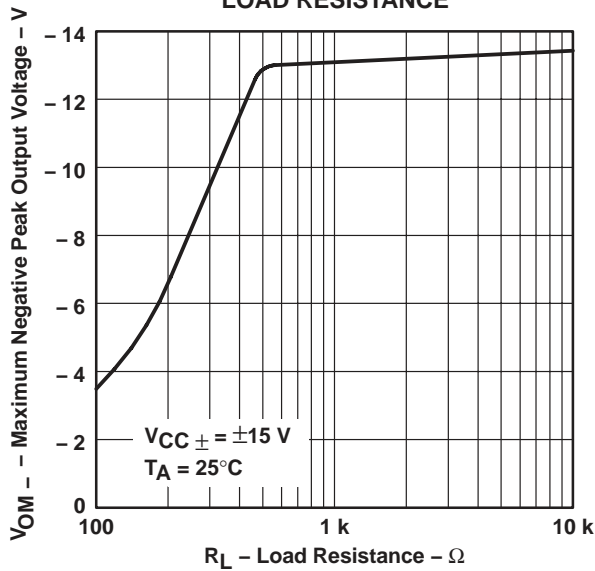

Figure 16

MAXIMUM POSITIVE PEAK
OUTPUT VOLTAGE†
vs
FREE-AIR TEMPERATURE

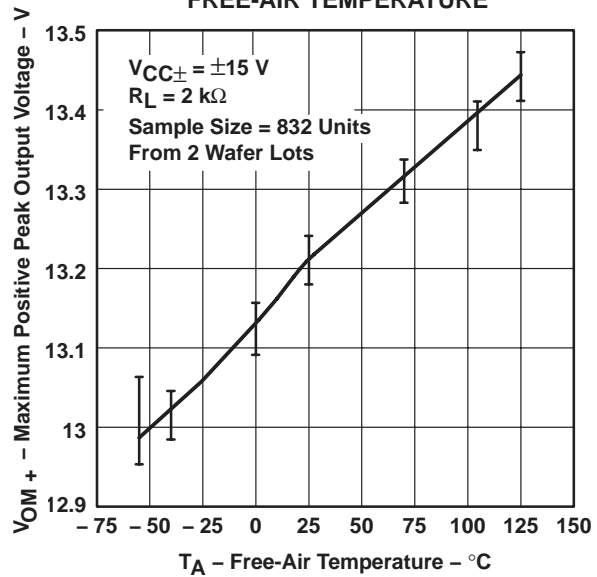
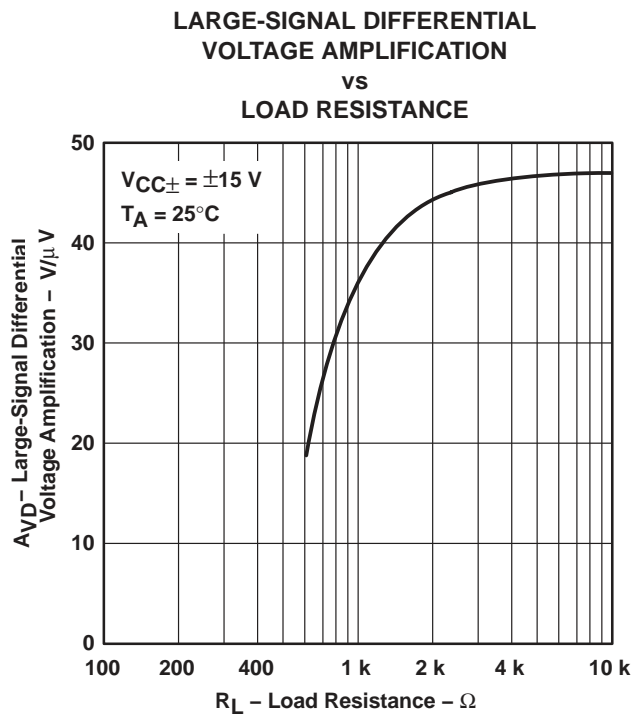
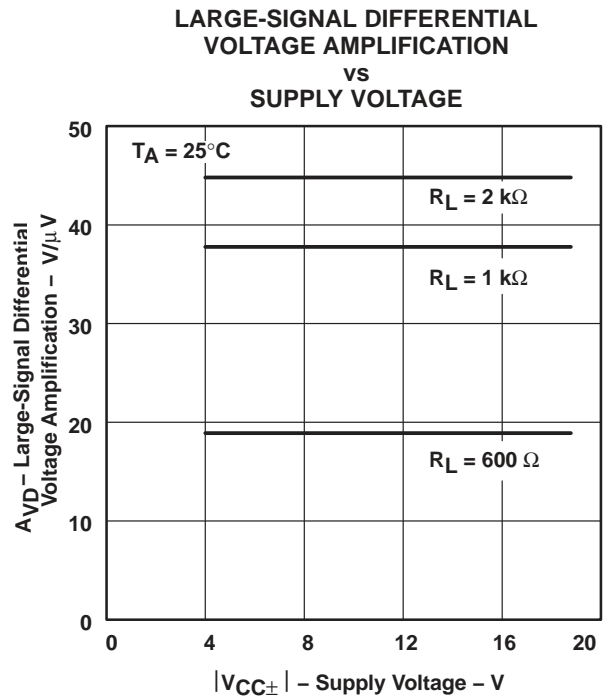
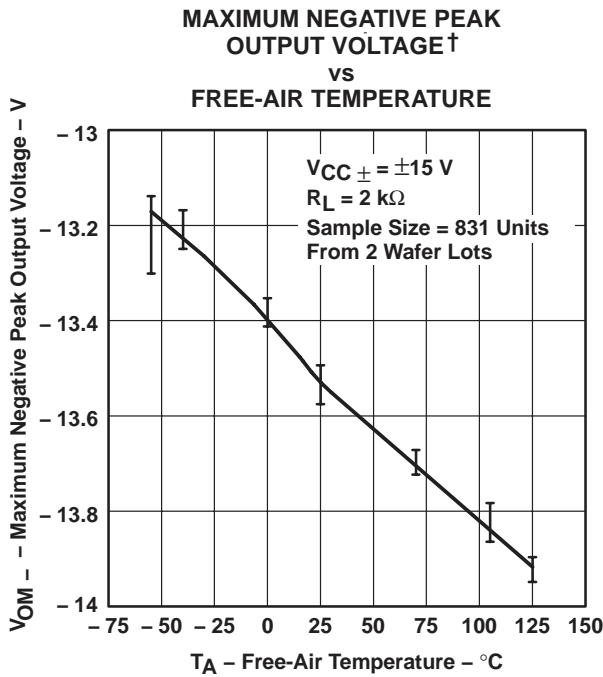

Figure 17

† Data at high and low temperatures are applicable only within the rated operating free-air temperature ranges of the various devices.



TYPICAL CHARACTERISTICS



† Data at high and low temperatures are applicable only within the rated operating free-air temperature ranges of the various devices.

TLE2027-Q1, TLE2037-Q1, TLE2027A-Q1, TLE2037A-Q1
EXCALIBUR LOW-NOISE HIGH-SPEED
PRECISION OPERATIONAL AMPLIFIERS

SGLS202A – OCTOBER 2003 – REVISED OCTOBER 2006

TYPICAL CHARACTERISTICS

TLE2027
LARGE-SIGNAL DIFFERENTIAL VOLTAGE
AMPLIFICATION AND PHASE SHIFT
vs
FREQUENCY

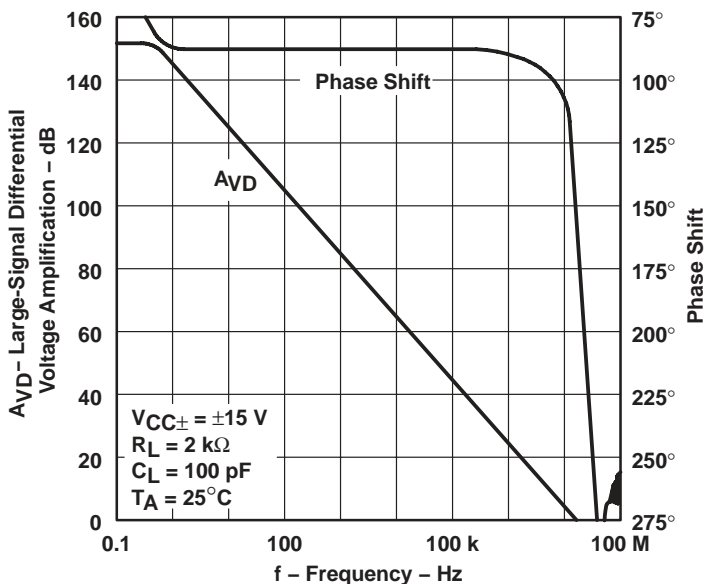

Figure 21

TLE2037
LARGE-SIGNAL DIFFERENTIAL VOLTAGE
AMPLIFICATION AND PHASE SHIFT
vs
FREQUENCY

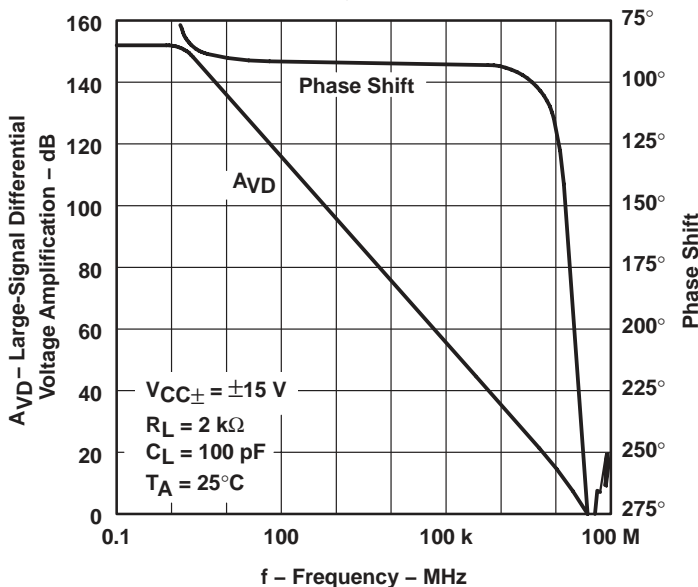

Figure 22



TYPICAL CHARACTERISTICS

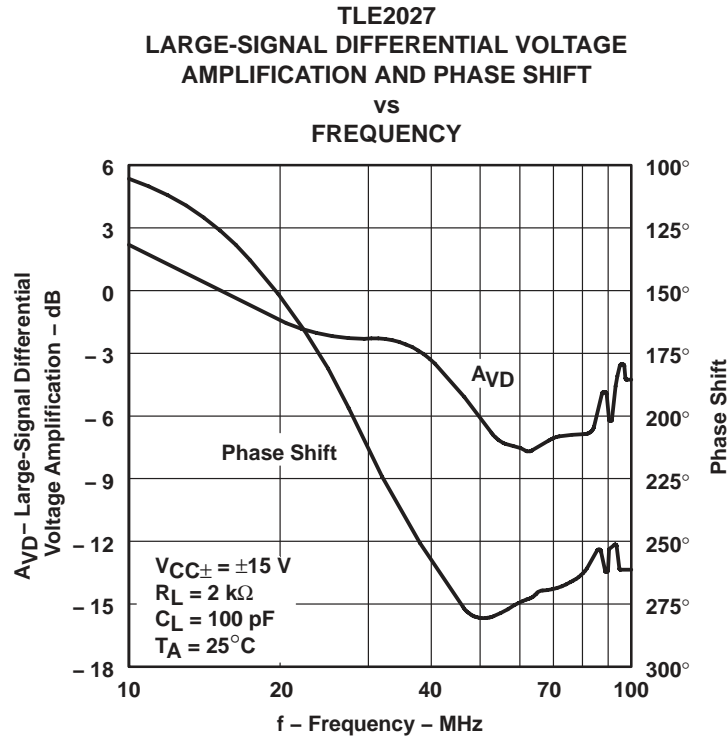

Figure 23

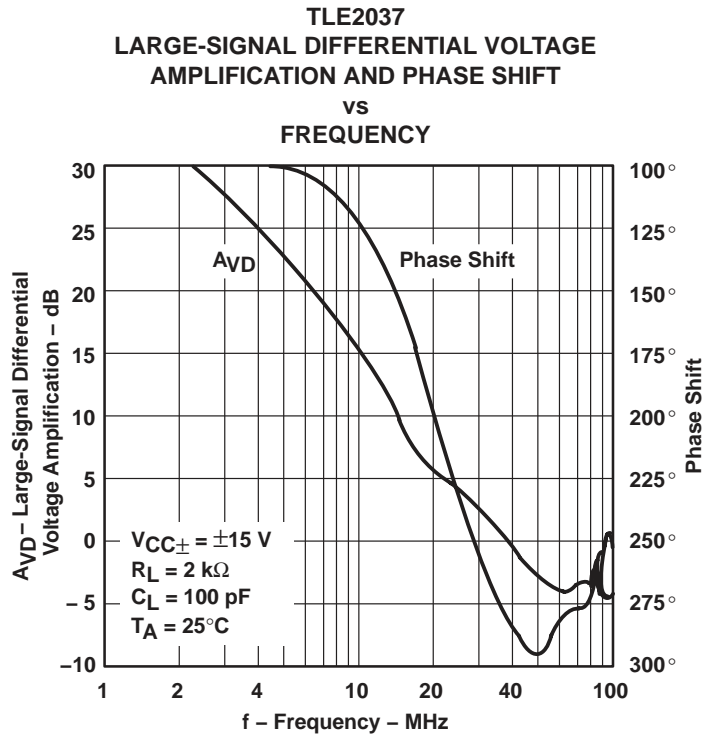

Figure 24

TLE2027-Q1, TLE2037-Q1, TLE2027A-Q1, TLE2037A-Q1
EXCALIBUR LOW-NOISE HIGH-SPEED
PRECISION OPERATIONAL AMPLIFIERS

SGLS202A – OCTOBER 2003 – REVISED OCTOBER 2006

TYPICAL CHARACTERISTICS

LARGE-SIGNAL DIFFERENTIAL VOLTAGE AMPLIFICATION†
VS
FREE-AIR TEMPERATURE

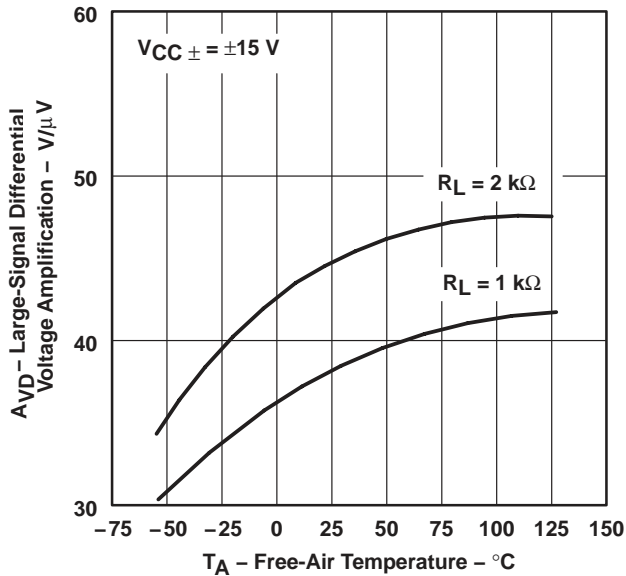
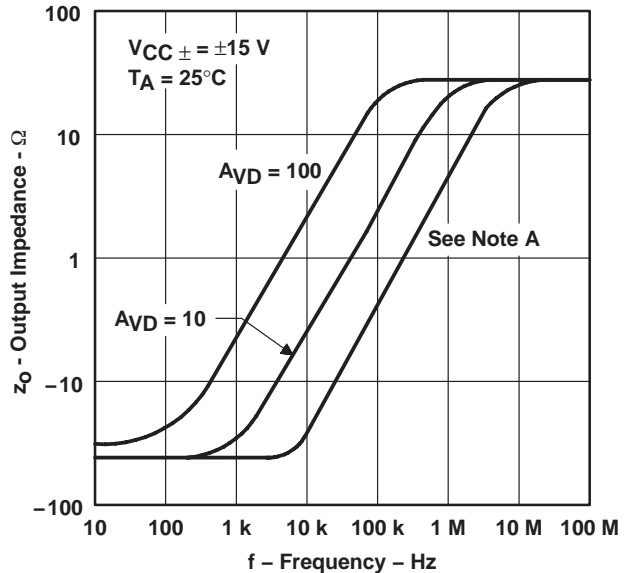

Figure 25

OUTPUT IMPEDANCE
VS
FREQUENCY



NOTE A: For this curve, the TLE2027 is $A_{VD} = 1$ and the TLE2037 is $A_{VD} = 5$.

Figure 26

COMMON-MODE REJECTION RATIO
VS
FREQUENCY

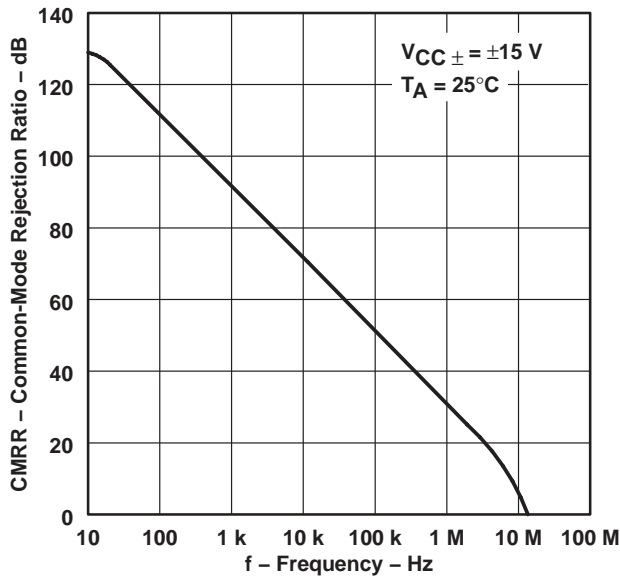

Figure 27

SUPPLY-VOLTAGE REJECTION RATIO
VS
FREQUENCY

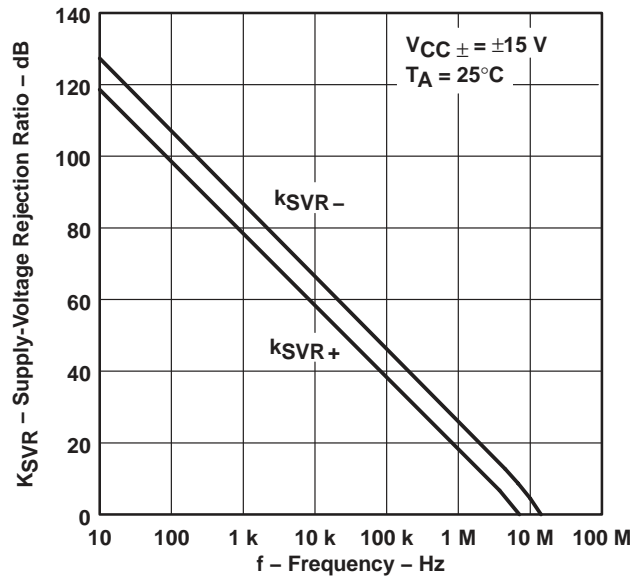

Figure 28

† Data at high and low temperatures are applicable only within the rated operating free-air temperature ranges of the various devices.



TYPICAL CHARACTERISTICS

SHORT-CIRCUIT OUTPUT CURRENT
 vs
 SUPPLY VOLTAGE

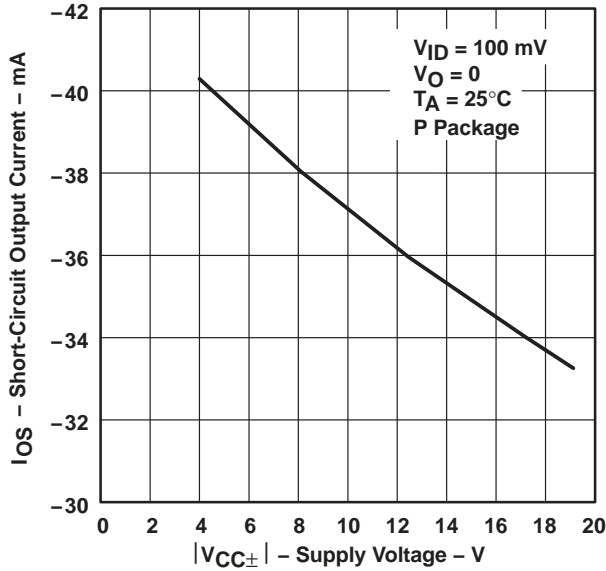

Figure 29

SHORT-CIRCUIT OUTPUT CURRENT
 vs
 SUPPLY VOLTAGE

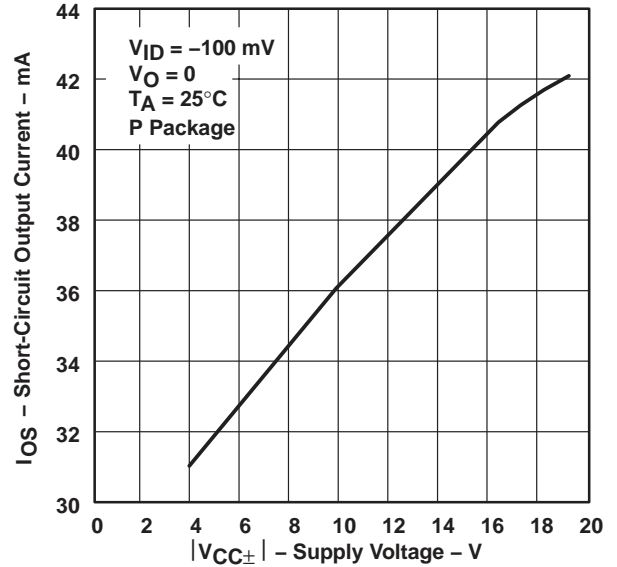

Figure 30

SHORT-CIRCUIT OUTPUT CURRENT
 vs
 ELAPSED TIME

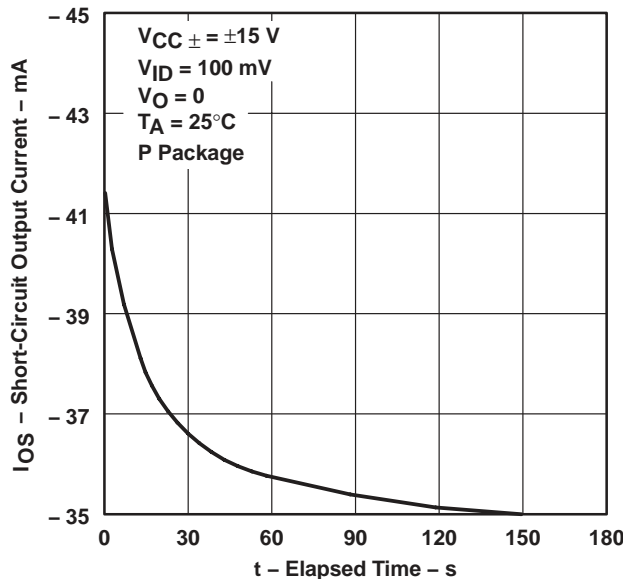

Figure 31

SHORT-CIRCUIT OUTPUT CURRENT
 vs
 ELAPSED TIME

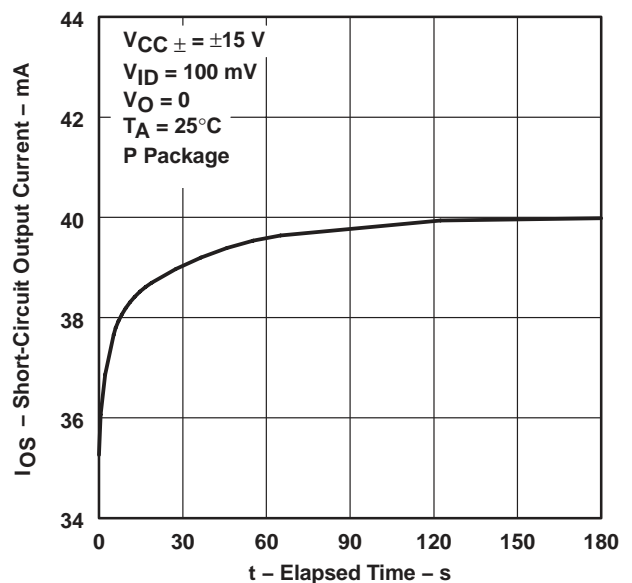

Figure 32

TLE2027-Q1, TLE2037-Q1, TLE2027A-Q1, TLE2037A-Q1
EXCALIBUR LOW-NOISE HIGH-SPEED
PRECISION OPERATIONAL AMPLIFIERS

SGLS202A – OCTOBER 2003 – REVISED OCTOBER 2006

TYPICAL CHARACTERISTICS

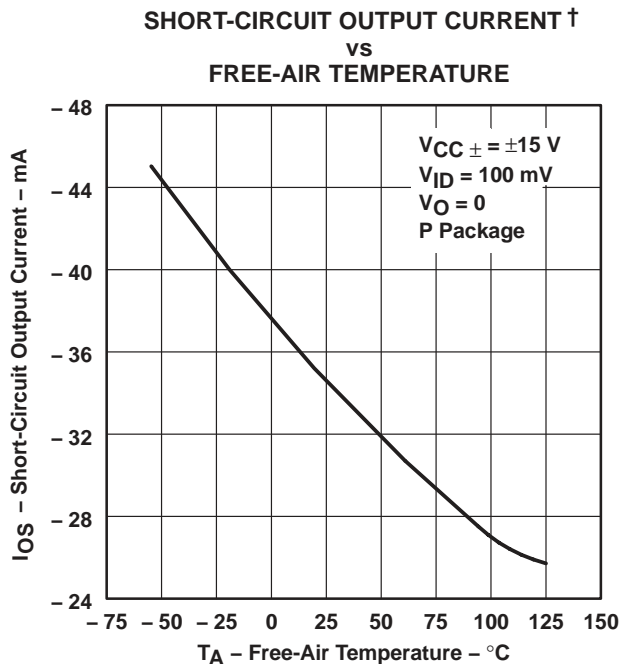

Figure 33

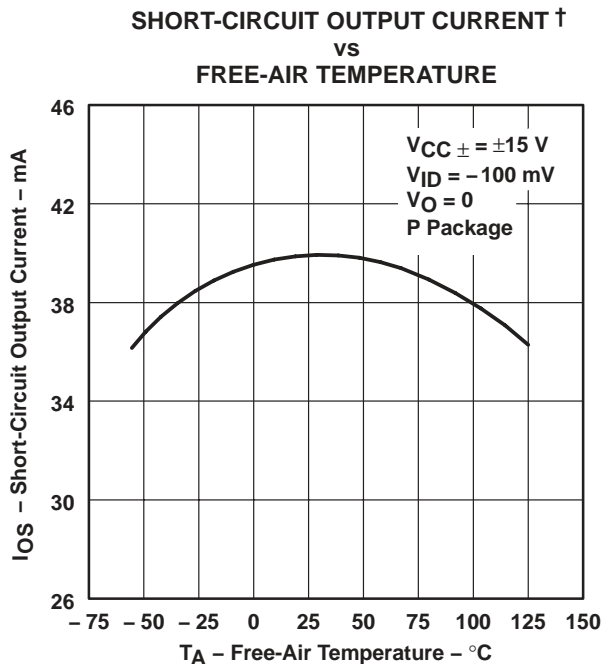

Figure 34

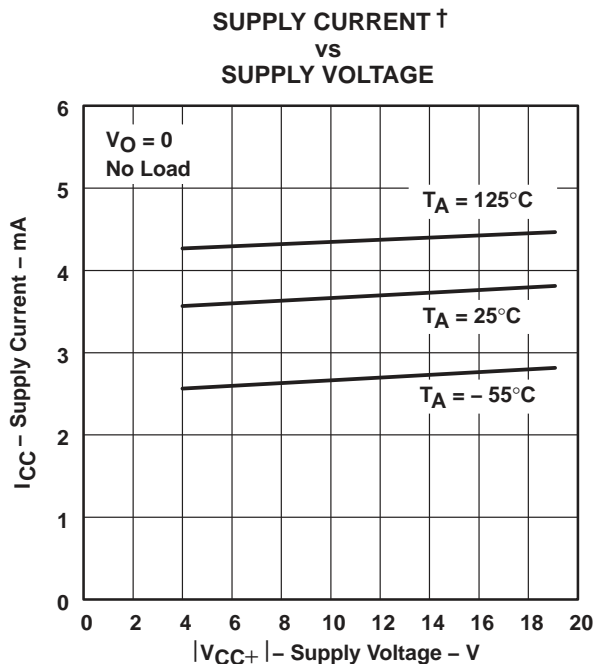

Figure 35

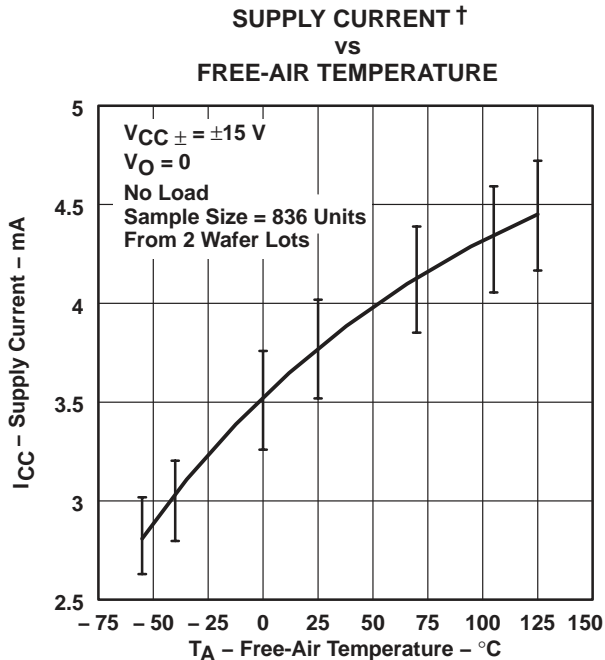

Figure 36

† Data at high and low temperatures are applicable only within the rated operating free-air temperature ranges of the various devices.



TYPICAL CHARACTERISTICS

**TLE2027
 VOLTAGE-FOLLOWER
 SMALL-SIGNAL
 PULSE RESPONSE**

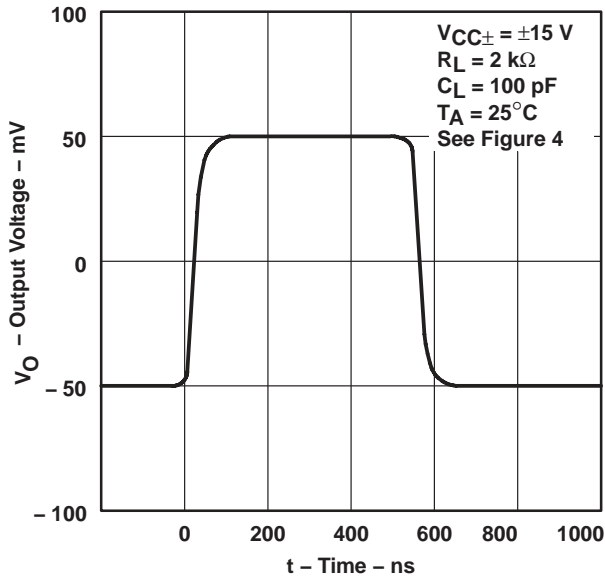

Figure 37

**TLE2027
 VOLTAGE-FOLLOWER
 LARGE-SIGNAL
 PULSE RESPONSE**

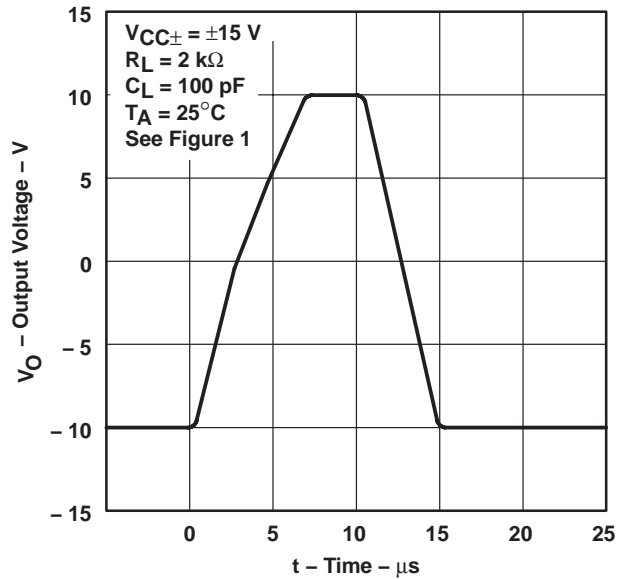

Figure 38

**TLE2037
 VOLTAGE-FOLLOWER
 SMALL-SIGNAL
 PULSE RESPONSE**

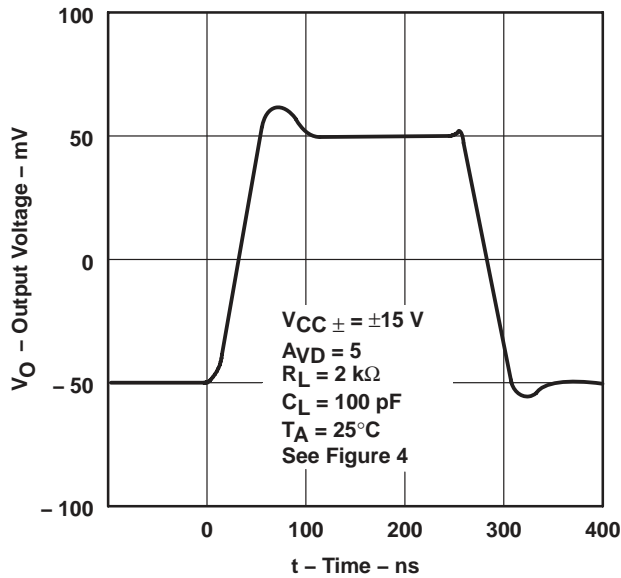

Figure 39

**TLE2037
 VOLTAGE-FOLLOWER
 LARGE-SIGNAL
 PULSE RESPONSE**

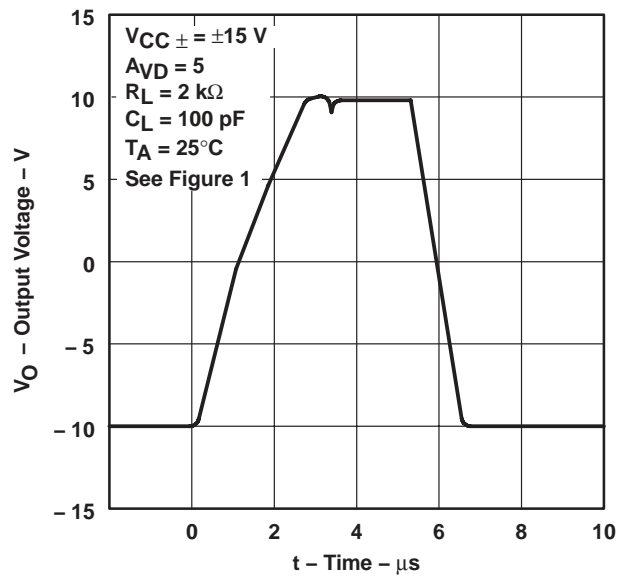

Figure 40

TLE2027-Q1, TLE2037-Q1, TLE2027A-Q1, TLE2037A-Q1
EXCALIBUR LOW-NOISE HIGH-SPEED
PRECISION OPERATIONAL AMPLIFIERS

SGLS202A – OCTOBER 2003 – REVISED OCTOBER 2006

TYPICAL CHARACTERISTICS

**EQUIVALENT INPUT NOISE VOLTAGE
 VS
 FREQUENCY**

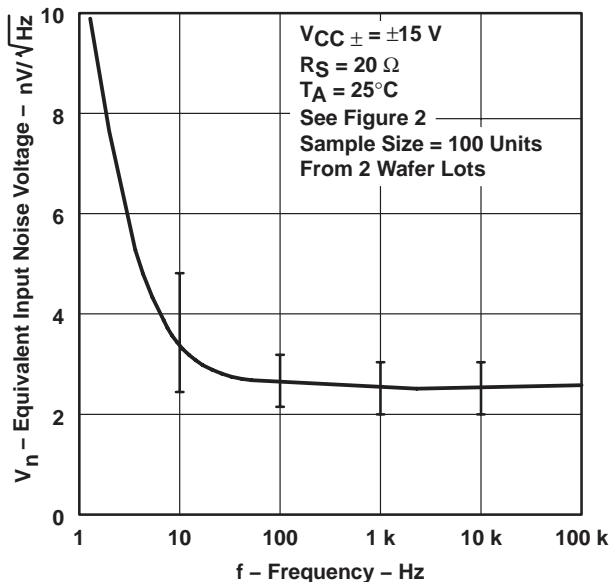

Figure 41

**NOISE VOLTAGE
 (REFERRED TO INPUT)
 OVER A 10-SECOND INTERVAL**

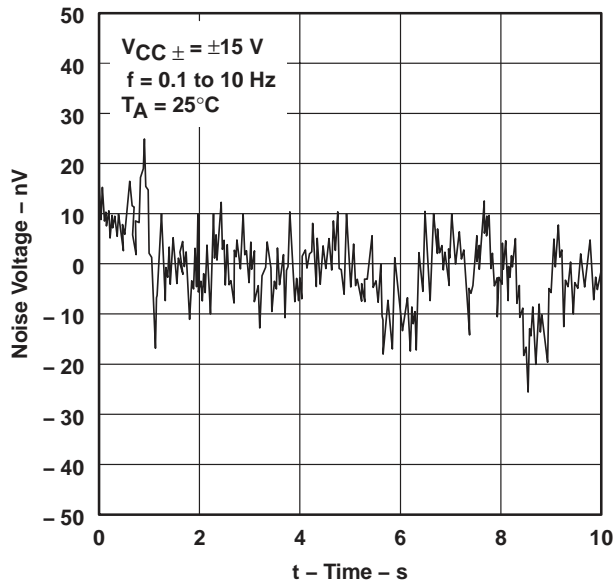

Figure 42

**TLE2027
 UNITY-GAIN BANDWIDTH
 VS
 SUPPLY VOLTAGE**

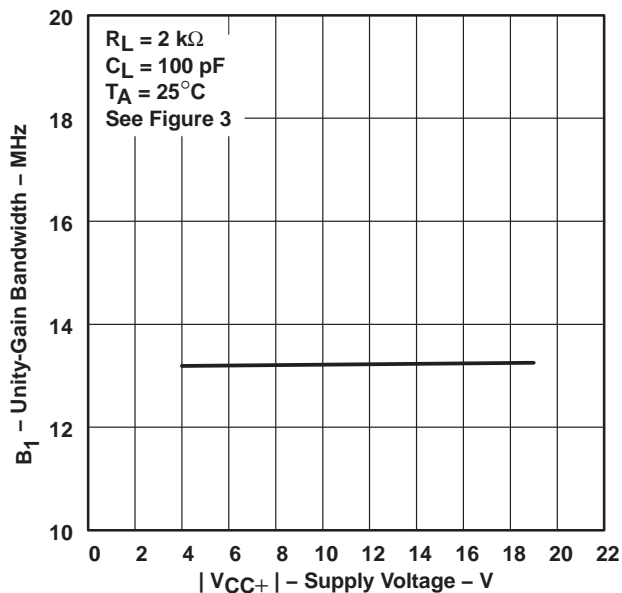

Figure 43

**TLE2037
 GAIN-BANDWIDTH PRODUCT
 VS
 SUPPLY VOLTAGE**

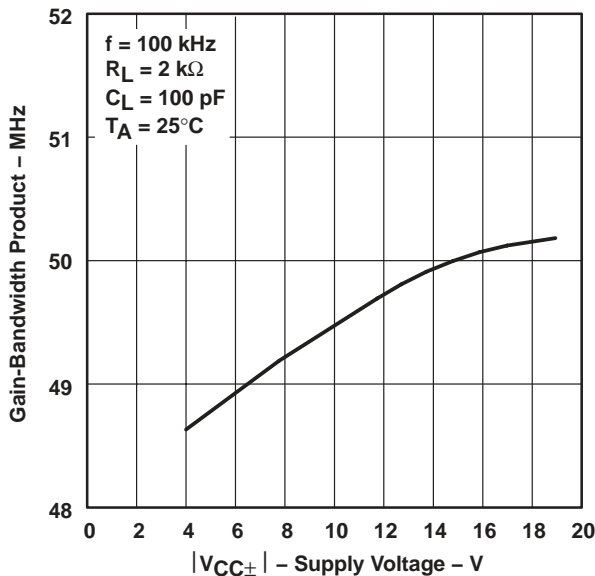
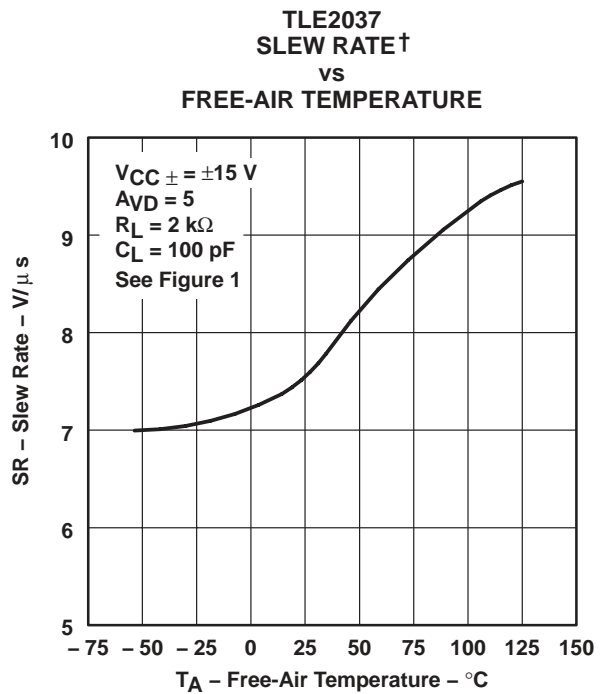
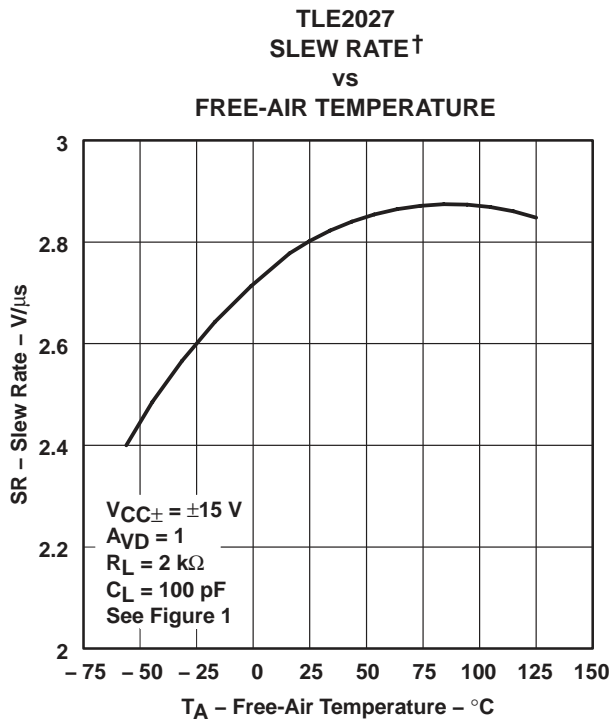
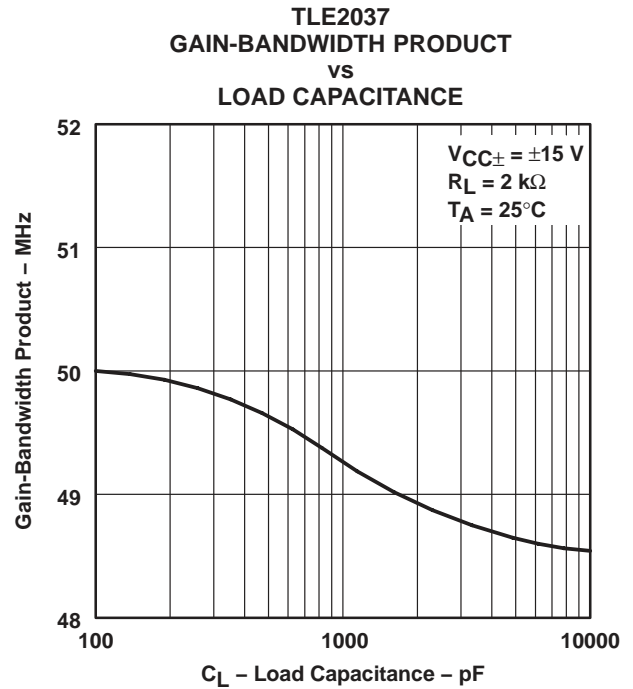
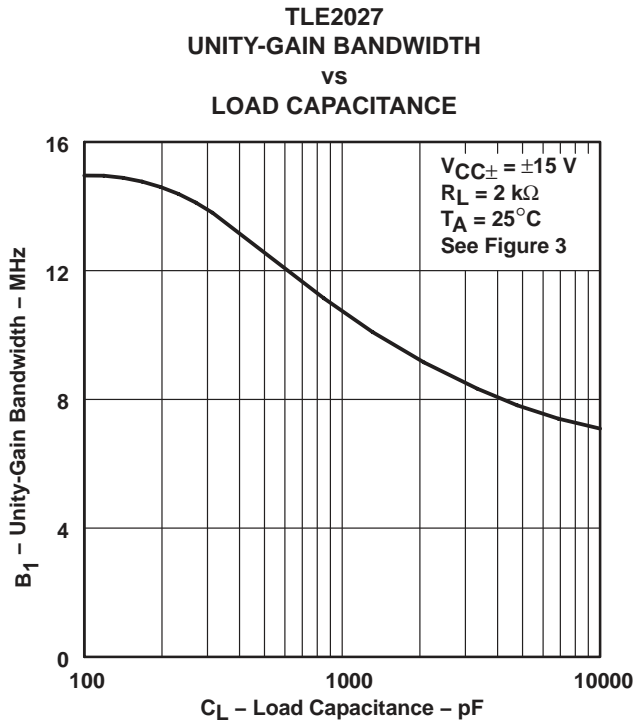

Figure 44



TYPICAL CHARACTERISTICS



† Data at high and low temperatures are applicable only within the rated operating free-air temperature ranges of the various devices.

TLE2027-Q1, TLE2037-Q1, TLE2027A-Q1, TLE2037A-Q1
EXCALIBUR LOW-NOISE HIGH-SPEED
PRECISION OPERATIONAL AMPLIFIERS

SGLS202A – OCTOBER 2003 – REVISED OCTOBER 2006

TYPICAL CHARACTERISTICS

TLE2027
PHASE MARGIN
vs
SUPPLY VOLTAGE

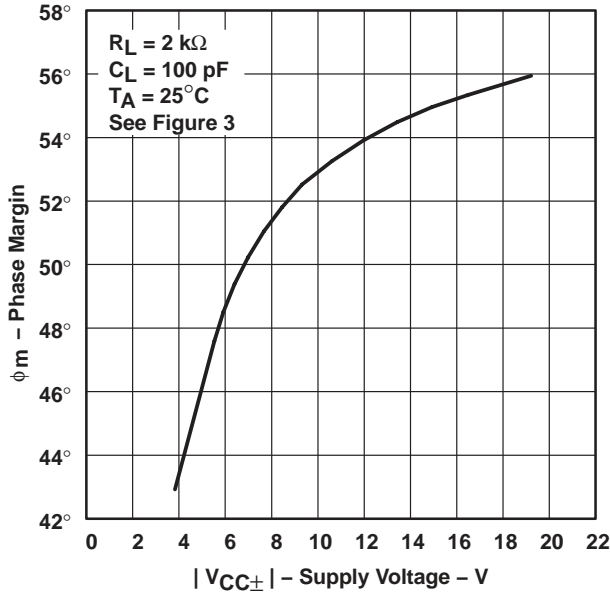

Figure 49

TLE2037
PHASE MARGIN
vs
SUPPLY VOLTAGE

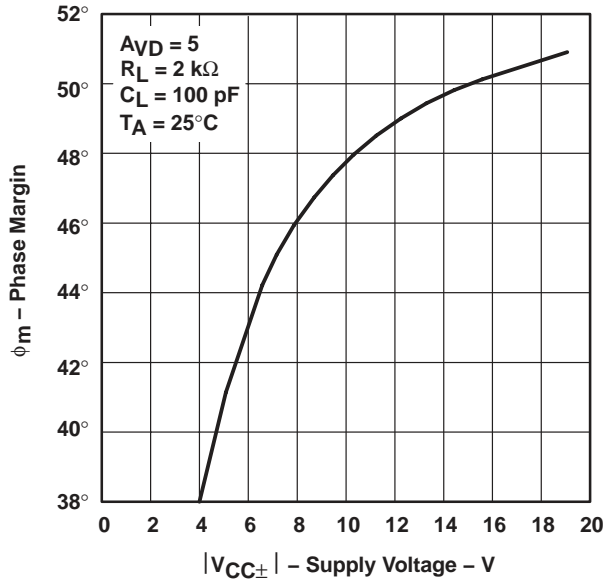

Figure 50

TLE2027
PHASE MARGIN
vs
LOAD CAPACITANCE

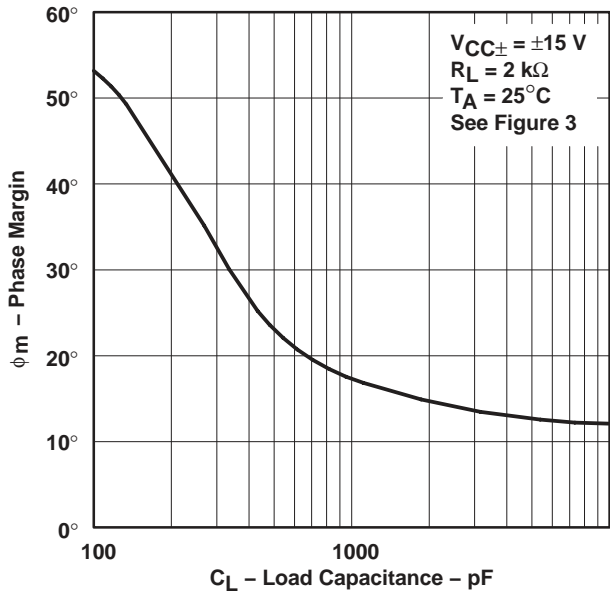

Figure 51

TLE2037
PHASE MARGIN
vs
LOAD CAPACITANCE

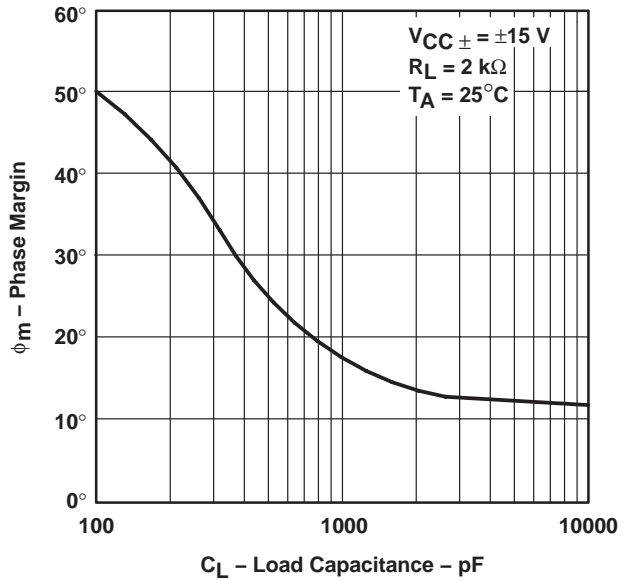
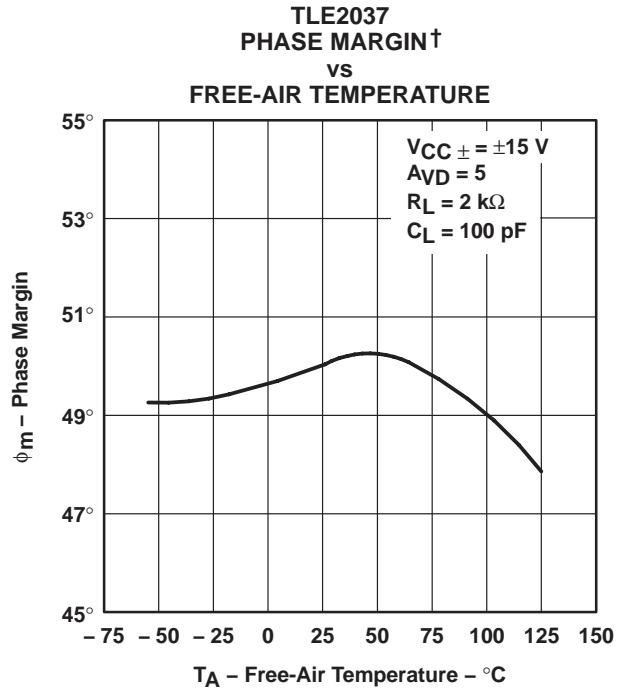
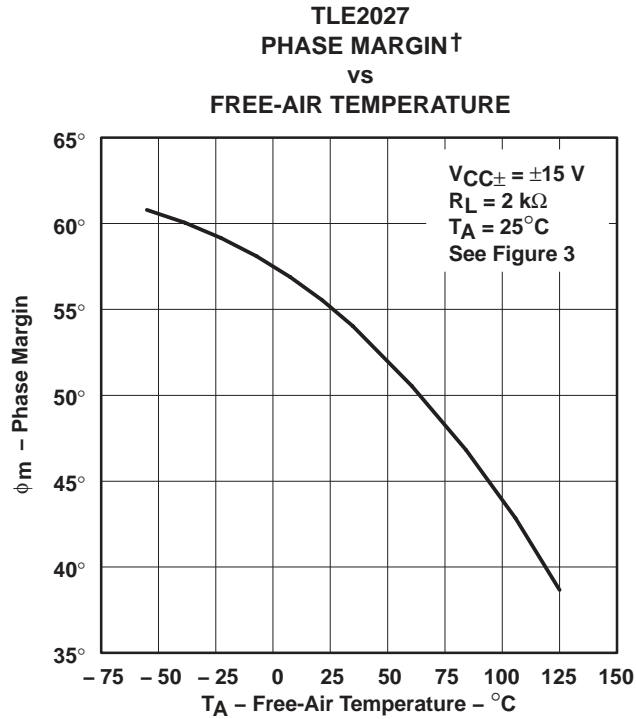

Figure 52



TYPICAL CHARACTERISTICS



† Data at high and low temperatures are applicable only within the rated operating free-air temperature ranges of the various devices.

APPLICATION INFORMATION

input offset voltage nulling

The TLE2027 and TLE2037 series offers external null pins that can be used to further reduce the input offset voltage. The circuits of Figure 55 can be connected as shown if the feature is desired. If external nulling is not needed, the null pins may be left disconnected.

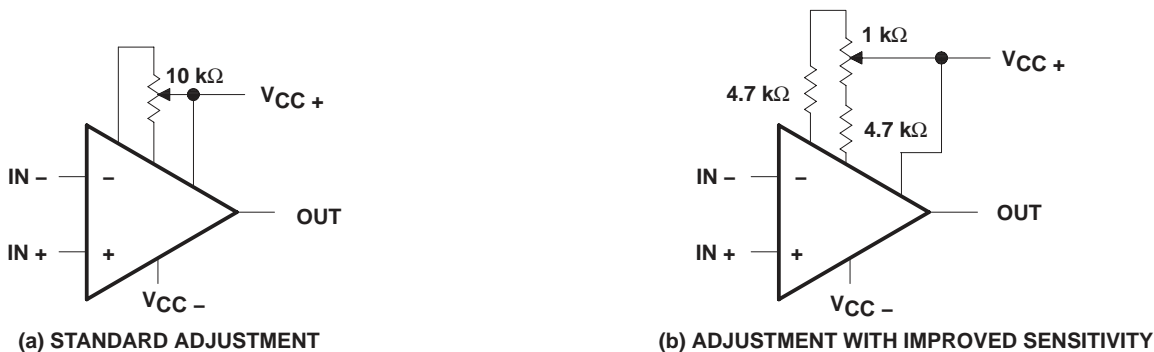

Figure 55. Input Offset Voltage Nulling Circuits

voltage-follower applications

The TLE2027 circuitry includes input-protection diodes to limit the voltage across the input transistors; however, no provision is made in the circuit to limit the current if these diodes are forward biased. This condition can occur when the device is operated in the voltage-follower configuration and driven with a fast, large-signal pulse. It is recommended that a feedback resistor be used to limit the current to a maximum of 1 mA to prevent degradation of the device. Also, this feedback resistor forms a pole with the input capacitance of the device. For feedback resistor values greater than 10 kΩ, this pole degrades the amplifier phase margin. This problem can be alleviated by adding a capacitor (20 pF to 50 pF) in parallel with the feedback resistor (see Figure 56).

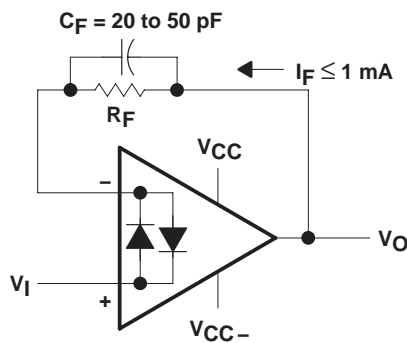

Figure 56. Voltage Follower

APPLICATION INFORMATION

macromodel information

Macromodel information provided was derived using Microsim *Parts*[™], the model generation software used with Microsim *PSpice*[™]. The Boyle macromodel (see Note 6) and subcircuit in Figure 57, Figure 58, and Figure 59 were generated using the TLE20x7 typical electrical and operating characteristics at 25°C. Using this information, output simulations of the following key parameters can be generated to a tolerance of 20% (in most cases):

- Maximum positive output voltage swing
- Maximum negative output voltage swing
- Slew rate
- Quiescent power dissipation
- Input bias current
- Open-loop voltage amplification
- Gain-bandwidth product
- Common-mode rejection ratio
- Phase margin
- DC output resistance
- AC output resistance
- Short-circuit output current limit

NOTE 6: G. R. Boyle, B. M. Cohn, D. O. Pederson, and J. E. Solomon, "Macromodeling of Integrated Circuit Operational Amplifiers", IEEE Journal of Solid-State Circuits, SC-9, 353 (1974).

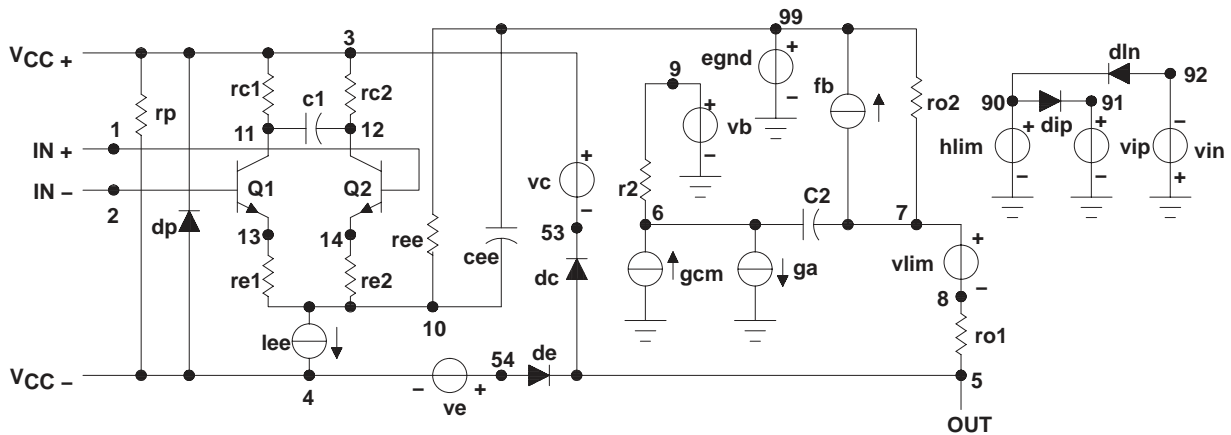

Figure 57. Boyle Macromodel

PSpice and *Parts* are trademarks of MicroSim Corporation.

TLE2027-Q1, TLE2037-Q1, TLE2027A-Q1, TLE2037A-Q1
EXCALIBUR LOW-NOISE HIGH-SPEED
PRECISION OPERATIONAL AMPLIFIERS

SGLS202A – OCTOBER 2003 – REVISED OCTOBER 2006

APPLICATION INFORMATION

macromodel information (continued)

```
.subckt TLE2027 1 2 3 4 5
*
c1      11  12  4.003E-12
c2      6   7   20.00E-12
dc      5   53  dz
de      54  5   dz
dlp     90  91  dz
dln     92  90  dx
dp      4   3   dz
egnd    99  0   poly(2) (3,0)
(4,0)  0  5   .5
fb      7   99  poly(5) vb vc
ve vlp vln 0 954.8E6 -1E9 1E9 1E9
-1E9
ga      6   0   11  12
2.062E-3
gcm     0   6   10  99
531.3E-12
iee     10  4   dc  56.01E-6
hlim    90  0   vlim 1K
q1      11  2   13 qx
q2      12  1   14 qx
r2      6   9   100.0E3
rc1     3   11  530.5
rc2     3   12  530.5
re1     13  10  -393.2
re2     14  10  -393.2
ree     10  99  3.571E6
ro1     8   5   25
ro2     7   99  25
rp      3   4   8.013E3
vb      9   0   dc  0
vc      3   53  dc  2.400
ve      54  4   dc  2.100
vlim    7   8   dc  0
vlp     91  0   dc  40
vln     0   92  dc  40
.modeldx D(Is=800.0E-18)
.modelqx NPN(Is=800.0E-18
Bf=7.000E3)
.ends
```

Figure 58. TLE2027 Macromodel Subcircuit

```
.subckt TLE2037 1 2 3 4 5
*
c1      11  12  4.003E-12
c2      6   7   7.500E-12
dc      5   53  dz
de      54  5   dz
dlp     90  91  dz
dln     92  90  dx
dp      4   3   dz
egnd    99  0   poly(2) (3,0)
(4,0)  0  .5  .5
fb      7   99  poly(5) vb vc
ve vip vln 0 923.4E6 A800E6
800E6 800E6 A800E6
ga      6   0   11  12  2.121E-3
gcm     0   6   10  99  597.7E-12
iee     10  4   dc  56.26E-6
hlim    90  0   vlim 1K
q1      11  2   13 qx
q2      12  1   14 qz
r2      6   9   100.0E3
rc1     3   11  471.5
rc2     3   12  471.5
re1     13  10  A448
re2     14  10  A448
ree     10  99  3.555E6
ro1     8   5   25
ro2     7   99  25
rp      3   4   8.013E3
vb      9   0   dc  0
vc      3   53  dc  2.400
ve      54  4   dc  2.100
vlim    7   8   dc  0
vlp     91  0   dc  40
vln     0   92  dc  40
.model  dxD(Is=800.0E-18)
.model  qxNPN(Is=800.0E-18
Bf=7.031E3)
.ends
```

Figure 59. TLE2037 Macromodel Subcircuit



PACKAGING INFORMATION

Orderable Device	Status (1)	Package Type	Package Drawing	Pins	Package Qty	Eco Plan (2)	Lead/Ball Finish (6)	MSL Peak Temp (3)	Op Temp (°C)	Device Marking (4/5)	Samples
TLE2037AQDRG4Q1	ACTIVE	SOIC	D	8	2500	Green (RoHS & no Sb/Br)	CU NIPDAU	Level-1-260C-UNLIM	-40 to 125	2037AQ1	Samples
TLE2037AQDRQ1	ACTIVE	SOIC	D	8	2500	Green (RoHS & no Sb/Br)	CU NIPDAU	Level-1-260C-UNLIM	-40 to 125	2037AQ1	Samples
TLE2037QDRG4Q1	ACTIVE	SOIC	D	8		TBD	Call TI	Call TI	-40 to 125	2037Q1	Samples
TLE2037QDRQ1	OBSOLETE	SOIC	D	8		TBD	Call TI	Call TI	-40 to 125	2037Q1	

(1) The marketing status values are defined as follows:

ACTIVE: Product device recommended for new designs.

LIFEBUY: TI has announced that the device will be discontinued, and a lifetime-buy period is in effect.

NRND: Not recommended for new designs. Device is in production to support existing customers, but TI does not recommend using this part in a new design.

PREVIEW: Device has been announced but is not in production. Samples may or may not be available.

OBSOLETE: TI has discontinued the production of the device.

(2) Eco Plan - The planned eco-friendly classification: Pb-Free (RoHS), Pb-Free (RoHS Exempt), or Green (RoHS & no Sb/Br) - please check <http://www.ti.com/productcontent> for the latest availability information and additional product content details.

TBD: The Pb-Free/Green conversion plan has not been defined.

Pb-Free (RoHS): TI's terms "Lead-Free" or "Pb-Free" mean semiconductor products that are compatible with the current RoHS requirements for all 6 substances, including the requirement that lead not exceed 0.1% by weight in homogeneous materials. Where designed to be soldered at high temperatures, TI Pb-Free products are suitable for use in specified lead-free processes.

Pb-Free (RoHS Exempt): This component has a RoHS exemption for either 1) lead-based flip-chip solder bumps used between the die and package, or 2) lead-based die adhesive used between the die and leadframe. The component is otherwise considered Pb-Free (RoHS compatible) as defined above.

Green (RoHS & no Sb/Br): TI defines "Green" to mean Pb-Free (RoHS compatible), and free of Bromine (Br) and Antimony (Sb) based flame retardants (Br or Sb do not exceed 0.1% by weight in homogeneous material)

(3) MSL, Peak Temp. - The Moisture Sensitivity Level rating according to the JEDEC industry standard classifications, and peak solder temperature.

(4) There may be additional marking, which relates to the logo, the lot trace code information, or the environmental category on the device.

(5) Multiple Device Markings will be inside parentheses. Only one Device Marking contained in parentheses and separated by a "~" will appear on a device. If a line is indented then it is a continuation of the previous line and the two combined represent the entire Device Marking for that device.

(6) Lead/Ball Finish - Orderable Devices may have multiple material finish options. Finish options are separated by a vertical ruled line. Lead/Ball Finish values may wrap to two lines if the finish value exceeds the maximum column width.

Important Information and Disclaimer:The information provided on this page represents TI's knowledge and belief as of the date that it is provided. TI bases its knowledge and belief on information provided by third parties, and makes no representation or warranty as to the accuracy of such information. Efforts are underway to better integrate information from third parties. TI has taken and continues to take reasonable steps to provide representative and accurate information but may not have conducted destructive testing or chemical analysis on incoming materials and chemicals. TI and TI suppliers consider certain information to be proprietary, and thus CAS numbers and other limited information may not be available for release.

In no event shall TI's liability arising out of such information exceed the total purchase price of the TI part(s) at issue in this document sold by TI to Customer on an annual basis.

OTHER QUALIFIED VERSIONS OF TLE2037-Q1, TLE2037A-Q1 :

- Catalog: [TLE2037](#), [TLE2037A](#)

NOTE: Qualified Version Definitions:

- Catalog - TI's standard catalog product

D (R-PDSO-G8)

PLASTIC SMALL OUTLINE

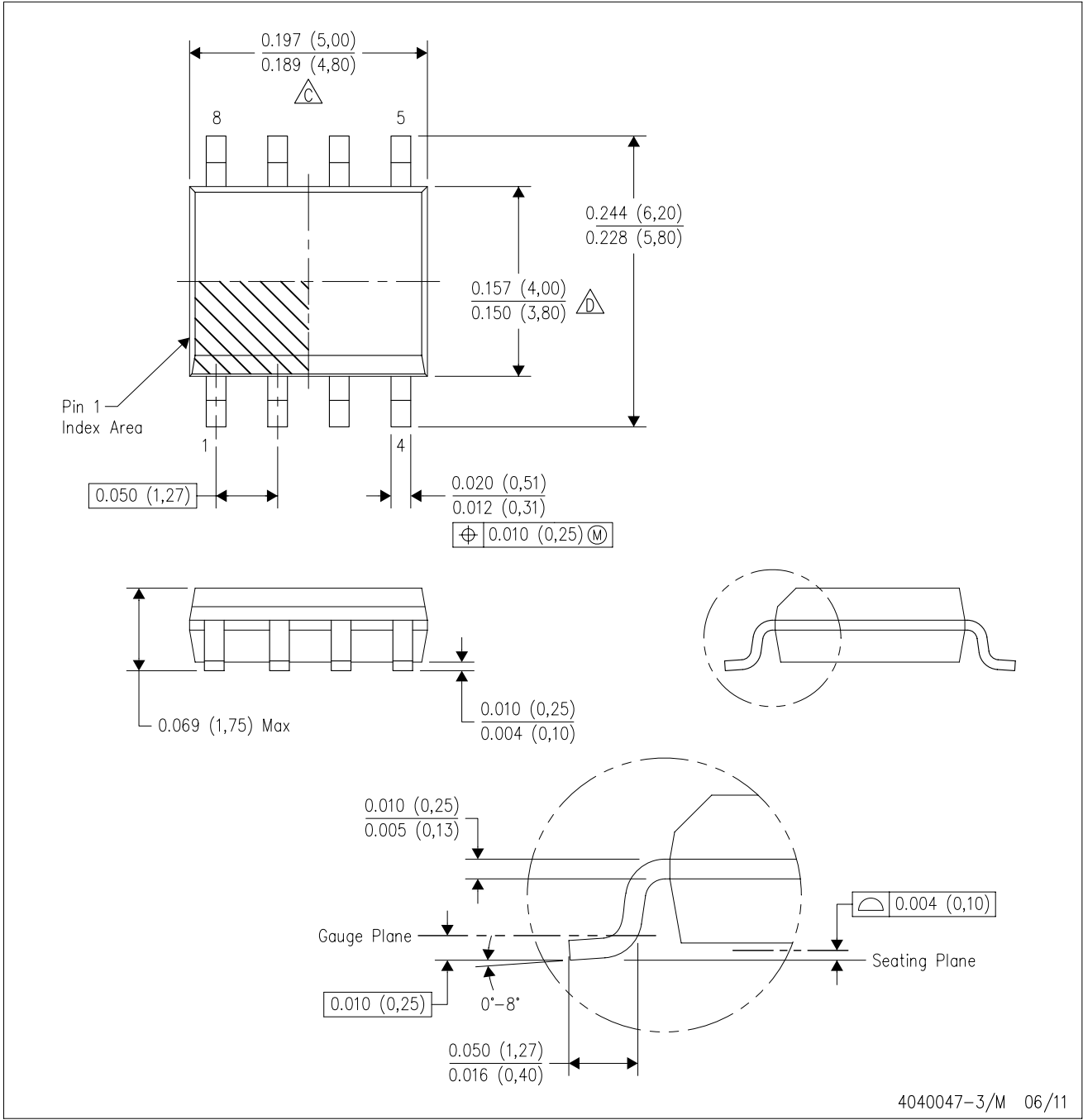

4040047-3/M 06/11

- NOTES:
- A. All linear dimensions are in inches (millimeters).
 - B. This drawing is subject to change without notice.
 - Body length does not include mold flash, protrusions, or gate burrs. Mold flash, protrusions, or gate burrs shall not exceed 0.006 (0,15) each side.
 - Body width does not include interlead flash. Interlead flash shall not exceed 0.017 (0,43) each side.
 - E. Reference JEDEC MS-012 variation AA.

D (R-PDSO-G8)

PLASTIC SMALL OUTLINE

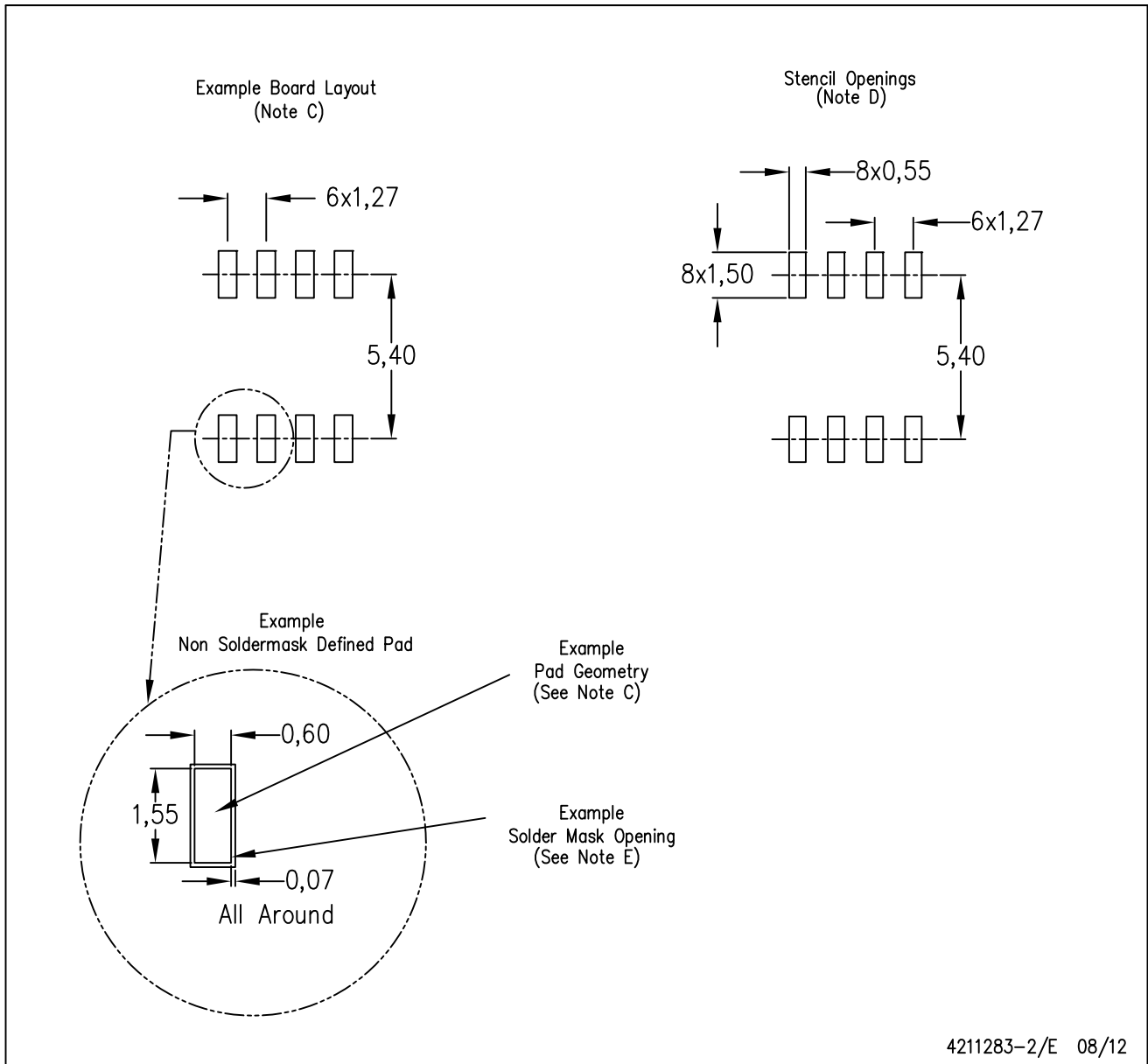

- NOTES:
- All linear dimensions are in millimeters.
 - This drawing is subject to change without notice.
 - Publication IPC-7351 is recommended for alternate designs.
 - Laser cutting apertures with trapezoidal walls and also rounding corners will offer better paste release. Customers should contact their board assembly site for stencil design recommendations. Refer to IPC-7525 for other stencil recommendations.
 - Customers should contact their board fabrication site for solder mask tolerances between and around signal pads.

IMPORTANT NOTICE

Texas Instruments Incorporated and its subsidiaries (TI) reserve the right to make corrections, enhancements, improvements and other changes to its semiconductor products and services per JESD46, latest issue, and to discontinue any product or service per JESD48, latest issue. Buyers should obtain the latest relevant information before placing orders and should verify that such information is current and complete. All semiconductor products (also referred to herein as "components") are sold subject to TI's terms and conditions of sale supplied at the time of order acknowledgment.

TI warrants performance of its components to the specifications applicable at the time of sale, in accordance with the warranty in TI's terms and conditions of sale of semiconductor products. Testing and other quality control techniques are used to the extent TI deems necessary to support this warranty. Except where mandated by applicable law, testing of all parameters of each component is not necessarily performed.

TI assumes no liability for applications assistance or the design of Buyers' products. Buyers are responsible for their products and applications using TI components. To minimize the risks associated with Buyers' products and applications, Buyers should provide adequate design and operating safeguards.

TI does not warrant or represent that any license, either express or implied, is granted under any patent right, copyright, mask work right, or other intellectual property right relating to any combination, machine, or process in which TI components or services are used. Information published by TI regarding third-party products or services does not constitute a license to use such products or services or a warranty or endorsement thereof. Use of such information may require a license from a third party under the patents or other intellectual property of the third party, or a license from TI under the patents or other intellectual property of TI.

Reproduction of significant portions of TI information in TI data books or data sheets is permissible only if reproduction is without alteration and is accompanied by all associated warranties, conditions, limitations, and notices. TI is not responsible or liable for such altered documentation. Information of third parties may be subject to additional restrictions.

Resale of TI components or services with statements different from or beyond the parameters stated by TI for that component or service voids all express and any implied warranties for the associated TI component or service and is an unfair and deceptive business practice. TI is not responsible or liable for any such statements.

Buyer acknowledges and agrees that it is solely responsible for compliance with all legal, regulatory and safety-related requirements concerning its products, and any use of TI components in its applications, notwithstanding any applications-related information or support that may be provided by TI. Buyer represents and agrees that it has all the necessary expertise to create and implement safeguards which anticipate dangerous consequences of failures, monitor failures and their consequences, lessen the likelihood of failures that might cause harm and take appropriate remedial actions. Buyer will fully indemnify TI and its representatives against any damages arising out of the use of any TI components in safety-critical applications.

In some cases, TI components may be promoted specifically to facilitate safety-related applications. With such components, TI's goal is to help enable customers to design and create their own end-product solutions that meet applicable functional safety standards and requirements. Nonetheless, such components are subject to these terms.

No TI components are authorized for use in FDA Class III (or similar life-critical medical equipment) unless authorized officers of the parties have executed a special agreement specifically governing such use.

Only those TI components which TI has specifically designated as military grade or "enhanced plastic" are designed and intended for use in military/aerospace applications or environments. Buyer acknowledges and agrees that any military or aerospace use of TI components which have **not** been so designated is solely at the Buyer's risk, and that Buyer is solely responsible for compliance with all legal and regulatory requirements in connection with such use.

TI has specifically designated certain components as meeting ISO/TS16949 requirements, mainly for automotive use. In any case of use of non-designated products, TI will not be responsible for any failure to meet ISO/TS16949.

Products

Audio	www.ti.com/audio
Amplifiers	amplifier.ti.com
Data Converters	dataconverter.ti.com
DLP® Products	www.dlp.com
DSP	dsp.ti.com
Clocks and Timers	www.ti.com/clocks
Interface	interface.ti.com
Logic	logic.ti.com
Power Mgmt	power.ti.com
Microcontrollers	microcontroller.ti.com
RFID	www.ti-rfid.com
OMAP Applications Processors	www.ti.com/omap
Wireless Connectivity	www.ti.com/wirelessconnectivity

Applications

Automotive and Transportation	www.ti.com/automotive
Communications and Telecom	www.ti.com/communications
Computers and Peripherals	www.ti.com/computers
Consumer Electronics	www.ti.com/consumer-apps
Energy and Lighting	www.ti.com/energy
Industrial	www.ti.com/industrial
Medical	www.ti.com/medical
Security	www.ti.com/security
Space, Avionics and Defense	www.ti.com/space-avionics-defense
Video and Imaging	www.ti.com/video

TI E2E Community

e2e.ti.com