

CDBM120L-HF Thru. CDBM140L-HF

Reverse Voltage: 20 to 40 Volts

Forward Current: 1.0 Amp

RoHS Device

Halogen free

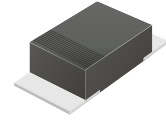

Features

- Ideal for surface mount applications.
- Easy pick and place.
- Plastic package has Underwriters Lab. flammability classification 94V-0.
- Exceeds environmental standard MIL-S-19500/228.
- Low leakage current.

Mechanical data

- Case: Mini SMA/SOD-123, molded plastic.
- Terminals: solderable per MIL-STD-750, method 2026.
- Polarity: Color band denotes cathode end.
- Approx. weight: 0.027 grams

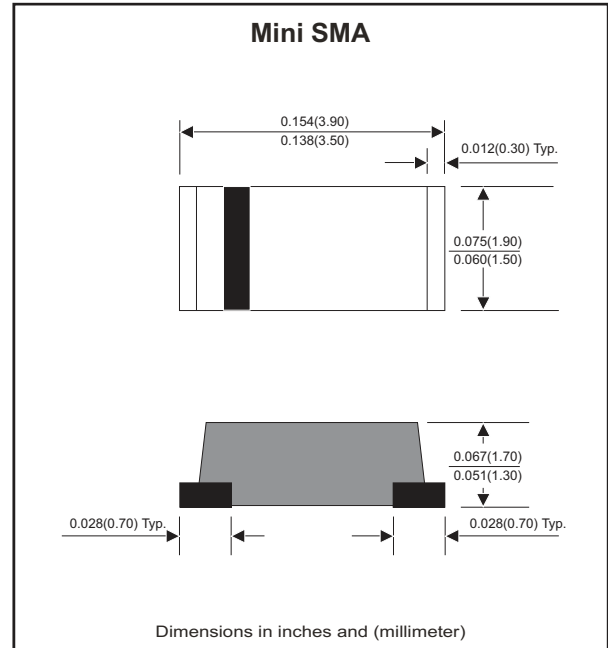

Maximum Ratings and Electrical Characteristics

Parameter	Symbol	CDBM120L-HF	CDBM130L-HF	CDBM140L-HF	Units
Max. Repetitive peak reverse voltage	V_{RRM}	20	30	40	V
Max. DC blocking voltage	V_R	20	30	40	V
Max. RMS voltage	V_{RMS}	14	21	28	V
Peak surge forward current, 8.3ms single half sine-wave superimposed on rate load (JEDEC method)	I_{FSM}	30			A
Max. average forward current	I_o	1.0			A
Max. instantaneous forward voltage at $I_F=1.0A$	V_F	0.38	0.40	0.40	V
Max. DC reverse current at $T_A=25^\circ C$	I_R	1.0			mA
Max. thermal resistance (Note 1)	$R_{\theta JA}$	42			$^\circ C/W$
Typ. Diode Junction capacitance ($F=1MHz$ and applied 4V DC reverse voltage)	C_J	130			$^\circ C$
Max. operating junction temperature	T_J	-55 to +100			$^\circ C$
Storage temperature	T_{STG}	-65 to +175			$^\circ C$

Notes: 1. Thermal resistance from junction to ambient and junction to lead, P.C.B. mounted on 0.2x0.2 inch² copper pad area.

RATING AND CHARACTERISTIC CURVES (CDBM120L-HF thru CDBM140L-HF)

Fig.1 - Typical Forward Characteristics

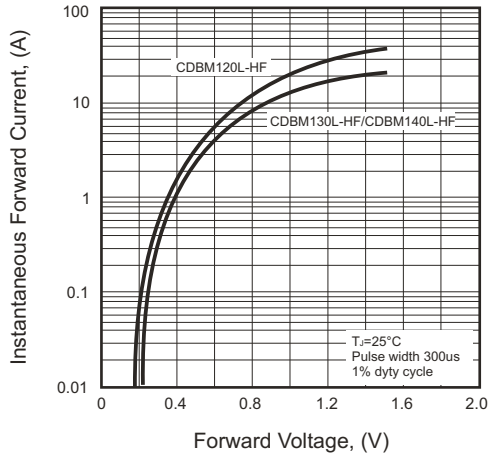

Fig.2 - Typical Forward Current Derating Curve

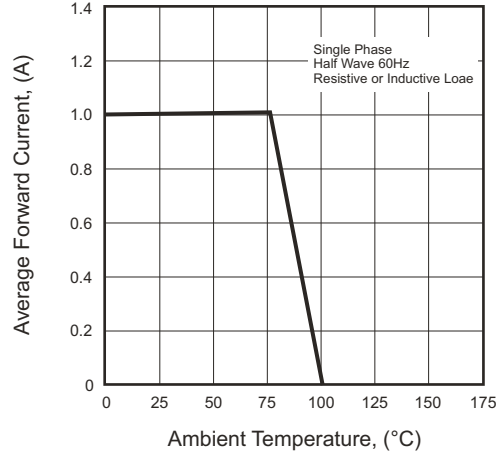

Fig.3 - Typical Reverse Characteristics

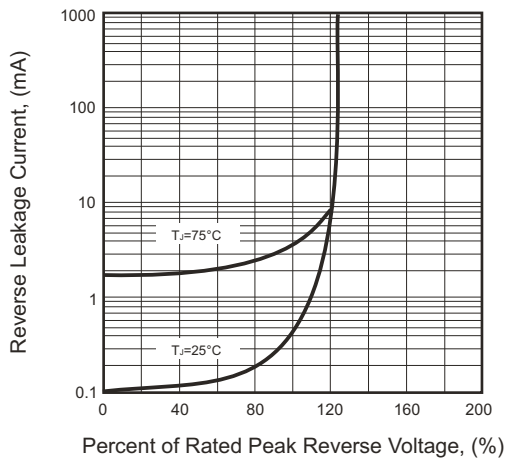

Fig.4 - Max. Non-repetitive Forward Surge Current

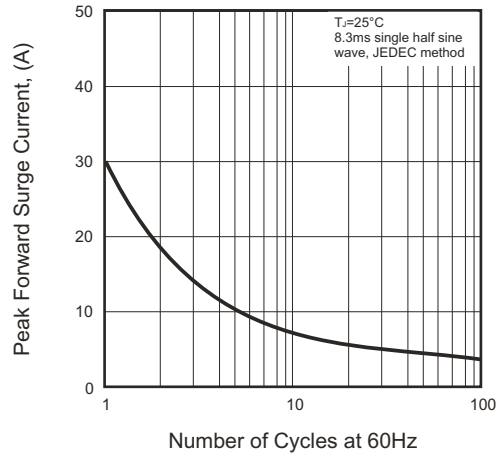
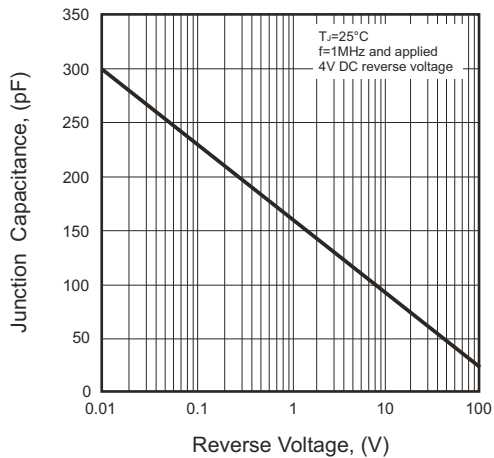
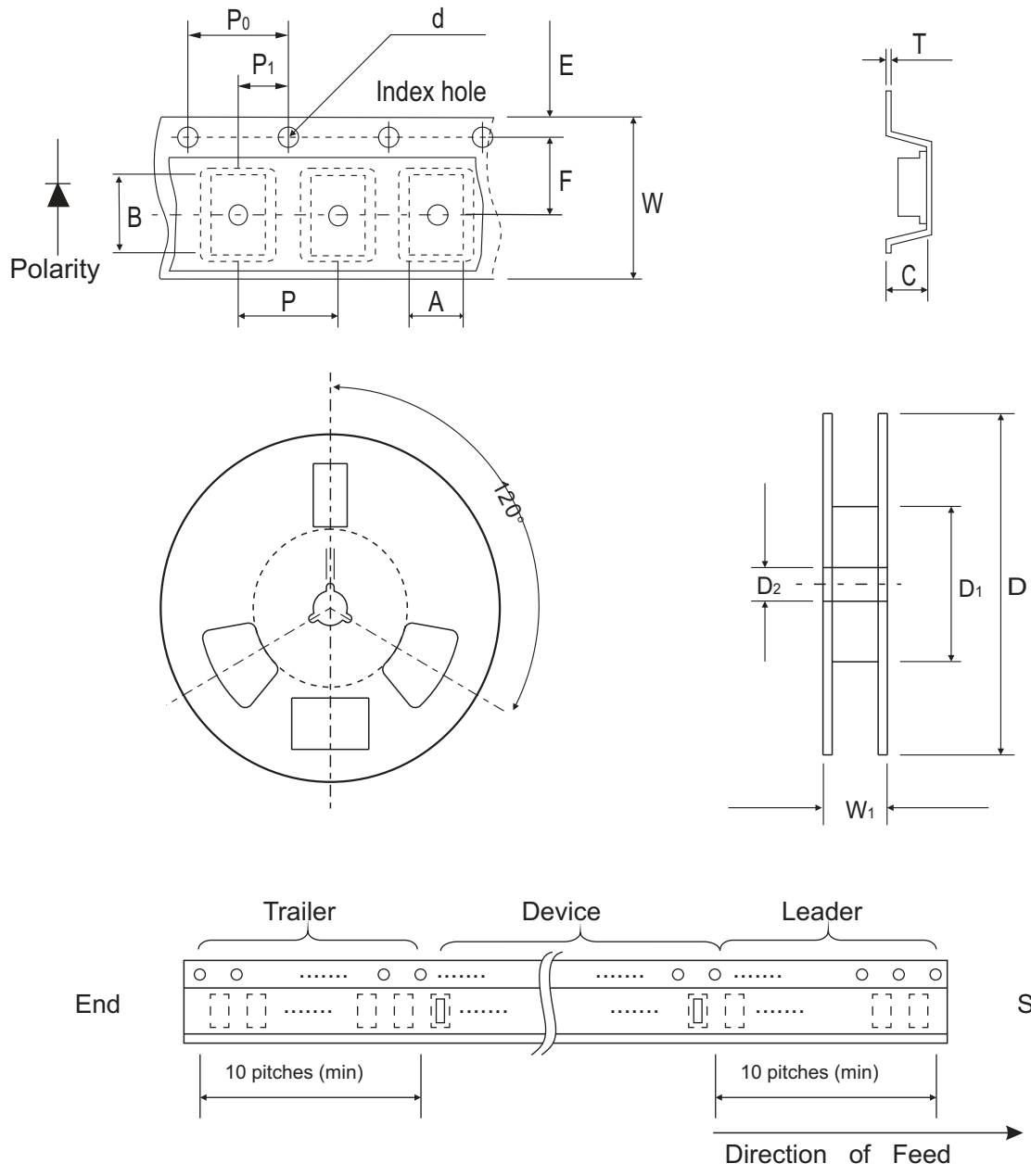

Fig.5 - Typical Junction Capacitance



Reel Taping Specification



	SYMBOL	A	B	C	d	D	D1	D2
Mini-SMA/SOD-123	(mm)	1.90 ± 0.10	3.90 ± 0.10	1.68 ± 0.10	1.50 ± 0.10	178 ± 2.00	62.0 MIN.	13.0 ± 0.50
	(inch)	0.075 ± 0.04	0.154 ± 0.04	0.066 ± 0.04	0.059 ± 0.004	7.00 ± 0.079	2.440 MIN.	0.512 ± 0.020

	SYMBOL	E	F	P	P0	P1	T	W	W1
Mini-SMA/SOD-123	(mm)	1.75 ± 0.10	3.50 ± 0.10	4.00 ± 0.10	4.00 ± 0.10	2.00 ± 0.10	0.23 ± 0.10	8.00 ± 0.30	11.40 ± 1.0
	(inch)	0.069 ± 0.004	0.138 ± 0.004	0.157 ± 0.004	0.157 ± 0.004	0.079 ± 0.004	0.009 ± 0.004	0.315 ± 0.012	0.449 ± 0.004

Marking Code

Part Number	Marking Code
CDBM120L-HF	L2
CDBM130L-HF	L3
CDBM140L-HF	L4



XX = Product type marking code

Suggested PAD Layout

SIZE	Mini-SMA/SOD-123	
	(mm)	(inch)
A	3.30	0.130
B	1.40	0.055
C	1.90	0.075
D	4.70	0.185
E	1.90	0.075

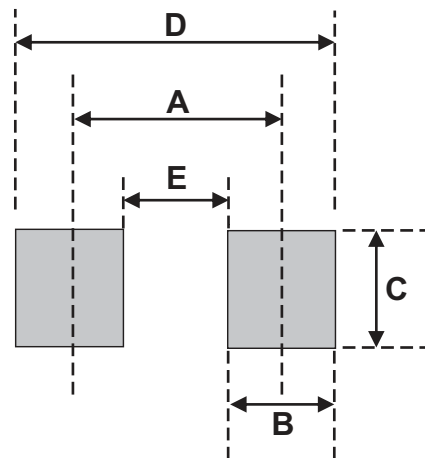

Standard Packaging

Case Type	REEL PACK	
	REEL (pcs)	Reel Size (inch)
Mini-SMA/SOD-123	2,500	7