

MMDFS3P303

Power MOSFET 3 Amps, 30 Volts

P-Channel SO-8, FETKY™

The FETKY product family incorporates low $R_{DS(on)}$, MOSFETs packaged with industry leading, low forward drop, low leakage Schottky Barrier rectifiers to offer high efficiency components in a space saving configuration. Independent pinouts for MOSFET and Schottky die allow the flexibility to use a single component for switching and rectification functions in a wide variety of applications such as Buck Converter, Buck-Boost, Synchronous Rectification, Low Voltage Motor Control, and Load Management in Battery Packs, Chargers, Cell Phones and other Portable Products.

- Power MOSFET with Low V_F , Low I_R Schottky Rectifier
- Lower Component Placement and Inventory Costs along with Board Space Savings
- R2 Suffix for Tape and Reel (2500 units/13" reel)
- Mounting Information for SO-8 Package Provided
- I_{DSS} Specified at Elevated Temperature
- Applications Information Provided
- Marking: 3P303

MOSFET MAXIMUM RATINGS ($T_J = 25^\circ\text{C}$ unless otherwise noted) (Notes 1. & 2.)

Rating	Symbol	Value	Unit
Drain-to-Source Voltage	V_{DSS}	30	Vdc
Drain-to-Gate Voltage ($R_{GS} = 1.0\text{ M}\Omega$)	V_{DGR}	30	Vdc
Gate-to-Source Voltage - Continuous	V_{GS}	± 20	Vdc
Drain Current			
- Continuous @ $T_A = 25^\circ\text{C}$	I_D	3.5	Adc
- Continuous @ $T_A = 100^\circ\text{C}$	I_D	2.25	
- Single Pulse ($t_p \leq 10\ \mu\text{s}$)	I_{DM}	12	Apk
Total Power Dissipation @ $T_A = 25^\circ\text{C}$ (Note 3.)	P_D	2.0	Watts
Single Pulse Drain-to-Source Avalanche Energy - STARTING $T_J = 25^\circ\text{C}$ $V_{DD} = 30\text{ Vdc}$, $V_{GS} = 10\text{ Vdc}$, $V_{DS} = 20\text{ Vdc}$, $I_L = 9.0\text{ Apk}$, $L = 10\text{ mH}$, $R_G = 25\ \Omega$	E_{AS}	375	mJ

1. Negative sign for P-channel device omitted for clarity.
2. Pulse Test: Pulse Width $\leq 250\ \mu\text{s}$, Duty Cycle $\leq 2.0\%$.
3. Mounted on 2" square FR4 board (1" sq. 2 oz. Cu 0.06" thick single sided), 10 sec. max.



ON Semiconductor™

<http://onsemi.com>

3 AMPERES
30 VOLTS
 $R_{DS(on)} = 100\text{ m}\Omega$
 $V_F = 0.42\text{ Volts}$

P-Channel

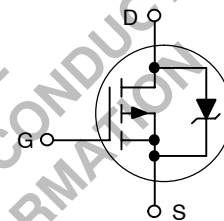

MARKING DIAGRAM

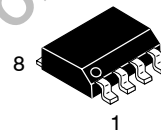

SO-8
CASE 751
STYLE 18

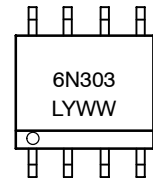

L = Location Code
Y = Year
WW = Work Week

PIN ASSIGNMENT

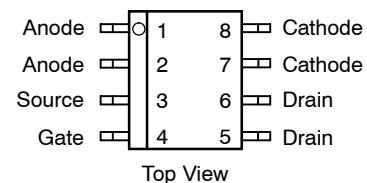

ORDERING INFORMATION

Device	Package	Shipping
MMDFS3P303R2	SO-8	2500 Tape & Reel

MMDFS3P303

SCHOTTKY RECTIFIER MAXIMUM RATINGS ($T_J = 25^\circ\text{C}$ unless otherwise noted)

Peak Repetitive Reverse Voltage DC Blocking Voltage	V_{RRM} V_R	30	Volts
Average Forward Current (Note 3.) (Rated V_R) $T_A = 100^\circ\text{C}$	I_O	3.0	Amps
Peak Repetitive Forward Current (Note 3.) (Rated V_R , Square Wave, 20 kHz) $T_A = 105^\circ\text{C}$	I_{frm}	6.0	Amps
Non-Repetitive Peak Surge Current (Surge applied at rated load conditions, halfwave, single phase, 60 Hz)	I_{fsm}	30	Amps

THERMAL CHARACTERISTICS – SCHOTTKY AND MOSFET

Thermal Resistance – Junction-to-Ambient (Note 1) – MOSFET	$R_{\theta JA}$	201	$^\circ\text{C/W}$
Thermal Resistance – Junction-to-Ambient (Note 2) – MOSFET	$R_{\theta JA}$	105	
Thermal Resistance – Junction-to-Ambient (Note 3.) – MOSFET	$R_{\theta JA}$	62.5	
Thermal Resistance – Junction-to-Ambient (Note 1) – Schottky	$R_{\theta JA}$	197	
Thermal Resistance – Junction-to-Ambient (Note 2) – Schottky	$R_{\theta JA}$	97	
Thermal Resistance – Junction-to-Ambient (Note 3.) – Schottky	$R_{\theta JA}$	62.5	
Operating and Storage Temperature Range	T_J, T_{stg}	-55 to 150	$^\circ\text{C}$

3. Mounted on 2" square FR4 board (1" sq. 2 oz. Cu 0.06" thick single sided), 10 sec. max.

1. Mounted with minimum recommended pad size, PC Board FR4.

2. Mounted on 2" square FR4 board (1" sq. 2 oz. Cu 0.06" thick single sided), Steady State.

MOSFET ELECTRICAL CHARACTERISTICS ($T_J = 25^\circ\text{C}$ unless otherwise noted) (Notes 1. & 3)

Characteristics	Symbol	Min	Typ	Max	Unit
OFF CHARACTERISTICS					
Drain-Source Voltage ($V_{GS} = 0\text{ Vdc}, I_D = 0.25\text{ mA}$) Temperature Coefficient (Positive)	$V_{(BR)DSS}$	30	-	-	Vdc
		-	27	-	$\text{mV}/^\circ\text{C}$
Zero Gate Drain Current ($V_{DS} = 30\text{ Vdc}, V_{GS} = 0\text{ Vdc}$) ($V_{DS} = 30\text{ Vdc}, V_{GS} = 0\text{ Vdc}, T_J = 125^\circ\text{C}$)	I_{DSS}	-	-	1.0	μAdc
		-	-	10	
Gate Body Leakage Current ($V_{GS} = \pm 20\text{ Vdc}, V_{DS} = 0$)	I_{GSS}	-	-	100	nAdc

ON CHARACTERISTICS (Note 3)

Gate Threshold Voltage ($V_{DS} = V_{GS}, I_D = 0.25\text{ mA}$) Temperature Coefficient (Negative)	$V_{GS(th)}$	1.0	1.7	-	Vdc
		-	3.5	-	$\text{mV}/^\circ\text{C}$
Static Drain-Source Resistance ($V_{GS} = 10\text{ Vdc}, I_D = 3.5\text{ Adc}$) ($V_{GS} = 4.5\text{ Vdc}, I_D = 2.0\text{ Adc}$)	$R_{DS(on)}$	-	0.085	0.100	Ω
		-	0.130	0.160	
Forward Transconductance ($V_{DS} = 15\text{ Vdc}, I_D = 3.5\text{ Adc}$)	g_{FS}	-	5.0	-	mhos

DYNAMIC CHARACTERISTICS

Input Capacitance	$(V_{DS} = 25\text{ Vdc}, V_{GS} = 0\text{ Vdc}, f = 1.0\text{ MHz})$	C_{iss}	-	405	-	pF
Output Capacitance		C_{oss}	-	200	-	
Reverse Transfer Capacitance		C_{rss}	-	55	-	

SWITCHING CHARACTERISTICS (Note 4)

Turn-On Delay Time	$(V_{DD} = 20\text{ Vdc}, I_D = 2.0\text{ Adc}, V_{GS} = 10\text{ Vdc}, R_G = 6.0\ \Omega)$	$t_{d(on)}$	-	12.5	25	ns
Rise Time		t_r	-	16	30	
Turn-Off Delay Time		$t_{d(off)}$	-	50	90	
Fall Time		t_f	-	35	65	

1. Negative signs for P-Channel device omitted for clarity.

3. Pulse Test: Pulse Width $\leq 300\ \mu\text{s}$, Duty Cycle $\leq 2\%$.

4. Switching characteristics are independent of operating junction temperature.

MMDFS3P303

MOSFET ELECTRICAL CHARACTERISTICS – continued ($T_J = 25^\circ\text{C}$ unless otherwise noted) (Notes 1. & 3)

Characteristics	Symbol	Min	Typ	Max	Unit	
SWITCHING CHARACTERISTICS – continued (Note 4)						
Turn-On Delay Time	$(V_{DD} = 20\text{ Vdc}, I_D = 2.0\text{ Adc}, V_{GS} = 4.5\text{ Vdc}, R_G = 6.0\ \Omega)$	$t_{d(on)}$	–	19	–	ns
Rise Time		t_r	–	36	–	
Turn-Off Delay Time		$t_{d(off)}$	–	27	–	
Fall Time		t_f	–	31	–	
Gate Charge	$(V_{DS} = 20\text{ Vdc}, I_D = 3.5\text{ Adc}, V_{GS} = 10\text{ Vdc})$	Q_T	–	14	25	nC
		Q_1	–	1.8	–	
		Q_2	–	4.5	–	
		Q_3	–	2.85	–	

DRAIN SOURCE DIODE CHARACTERISTICS

Forward On-Voltage (Note 3)	$(I_S = 1.7\text{ Adc}, V_{GS} = 0\text{ Vdc})$	V_{SD}	–	0.9	1.2	V
Reverse Recovery Time	$(V_{GS} = 0\text{ V}, I_S = 3.5\text{ A}, dI_S/dt = 100\text{ A}/\mu\text{s})$	t_{rr}	–	26.6	–	ns
		t_a	–	18.8	–	
		t_b	–	7.8	–	
Reverse Recovery Stored Charge		Q_{RR}	–	0.03	–	μC

SCHOTTKY RECTIFIER ELECTRICAL CHARACTERISTICS ($T_C = 25^\circ\text{C}$ unless otherwise noted)

Maximum Instantaneous Forward Voltage (Note 3) $I_F = 100\text{ mA}, I_F = 3.0\text{ Adc}, I_F = 6.0\text{ Adc}$	V_F	$T_J = 25^\circ\text{C}$	$T_J = 125^\circ\text{C}$	Volts
		0.28	0.13	
		0.42	0.33	
		0.50	0.45	
Maximum Instantaneous Reverse Current (Note 3) $V_R = 30\text{ V}$	I_R	$T_J = 25^\circ\text{C}$	$T_J = 125^\circ\text{C}$	μA
		250	–	
		–	25	mA
Maximum Voltage Rate of Change $V_R = 30\text{ V}$	dV/dt	10,000		$\text{V}/\mu\text{s}$

1. Negative signs for P-Channel device omitted for clarity.
6. Pulse Test: Pulse Width $\leq 300\ \mu\text{s}$, Duty Cycle $\leq 2\%$.
7. Switching characteristics are independent of operating junction temperature.

TYPICAL FET ELECTRICAL CHARACTERISTICS

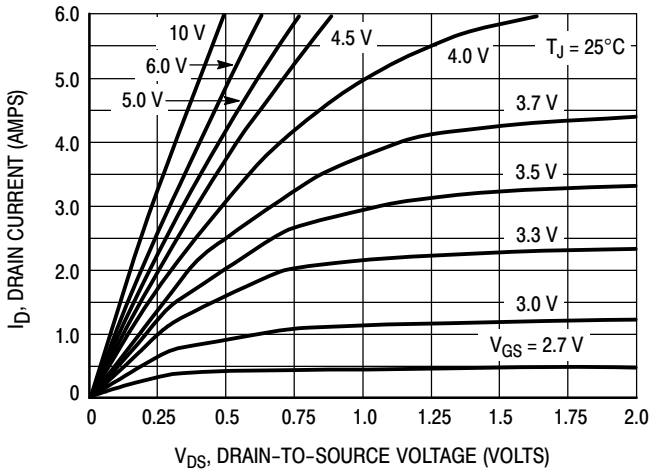

Figure 1. On-Region Characteristics

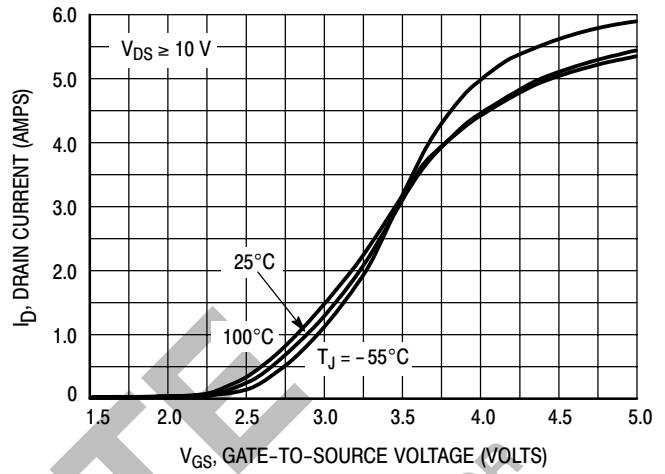

Figure 2. Transfer Characteristics

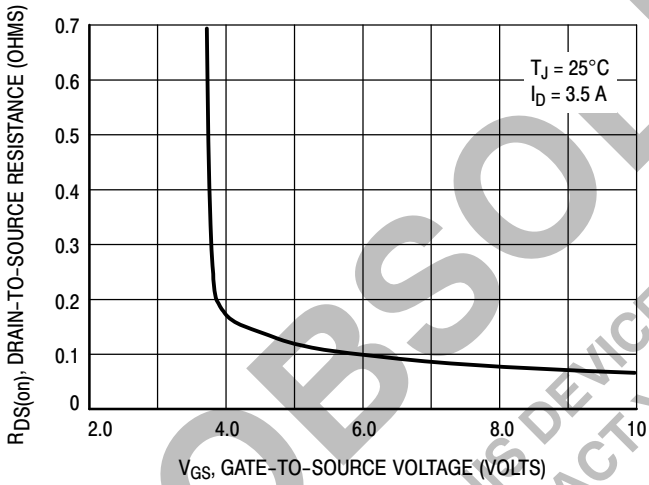

Figure 3. On-Resistance versus Gate-to-Source Voltage

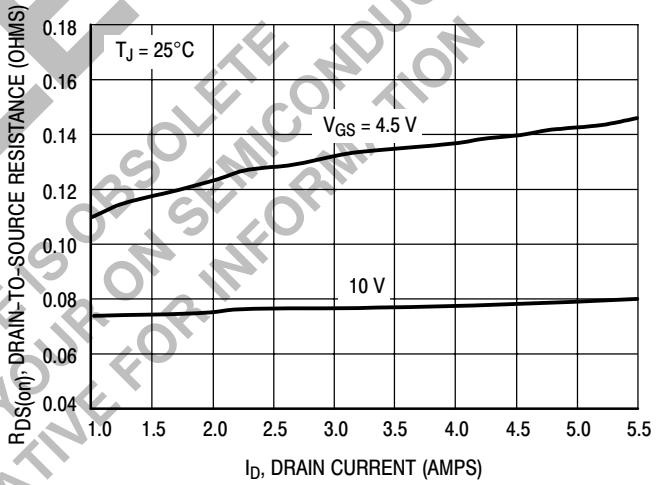

Figure 4. On-Resistance versus Drain Current and Gate Voltage

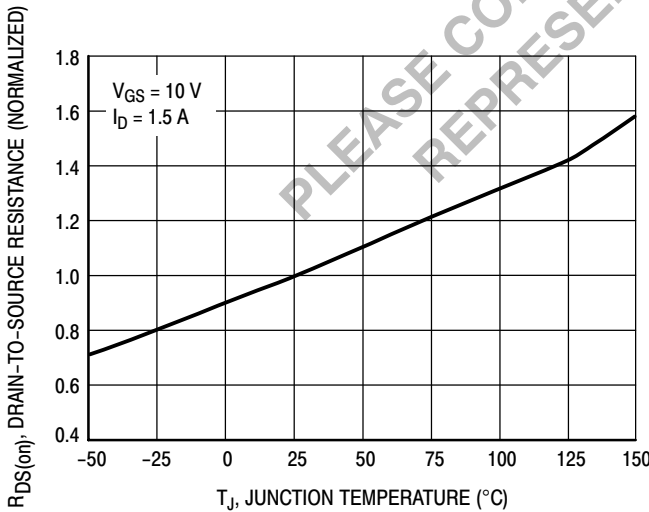

Figure 5. On-Resistance Variation with Temperature

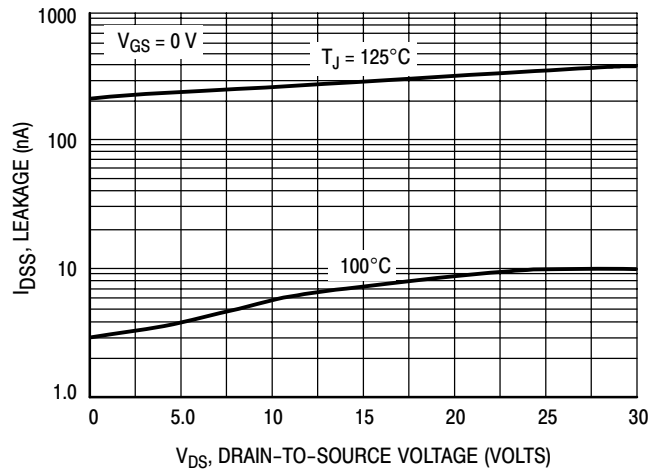

Figure 6. Drain-to-Source Leakage Current versus Voltage

TYPICAL FET ELECTRICAL CHARACTERISTICS

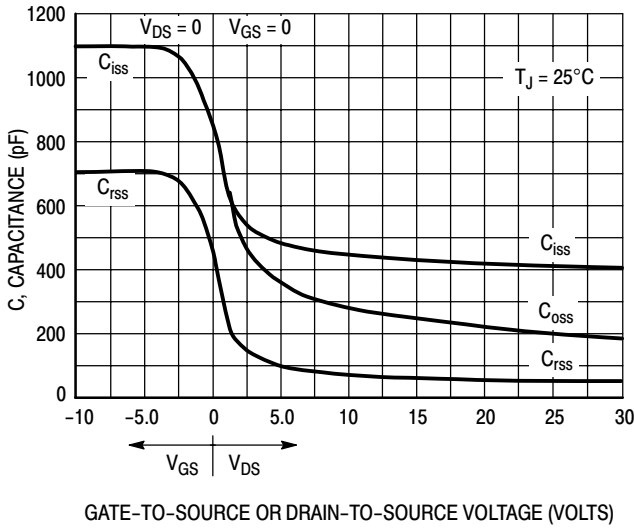

Figure 7. Capacitance Variation

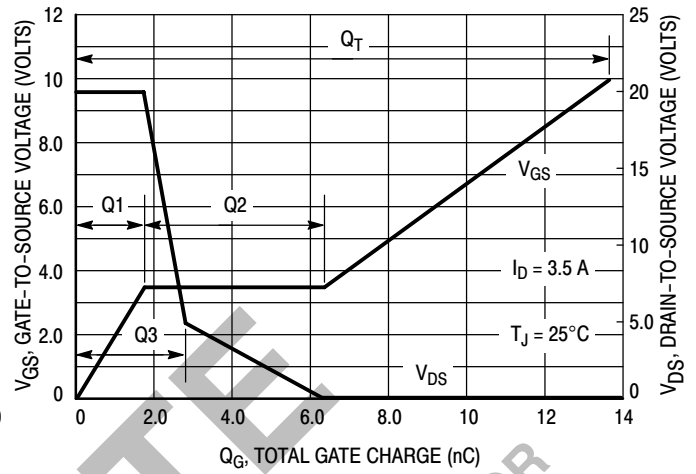

Figure 8. Gate-To-Source and Drain-To-Source Voltage versus Total Charge

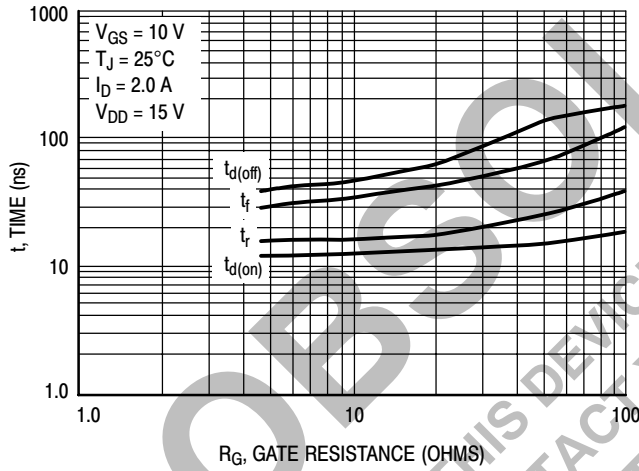

Figure 9. Resistive Switching Time Variation versus Gate Resistance

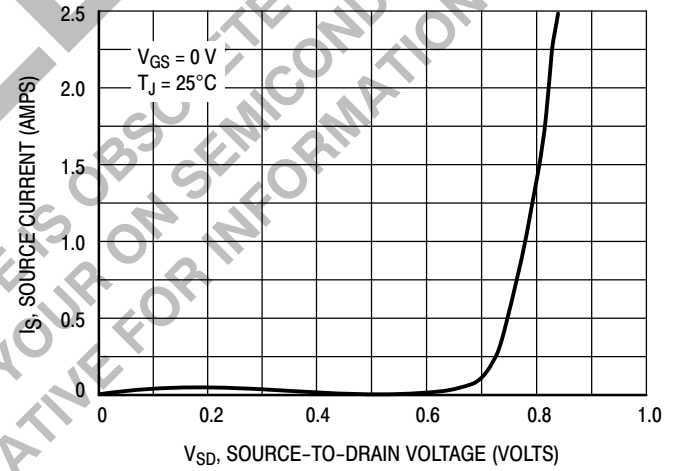

Figure 10. Diode Forward Voltage versus Current

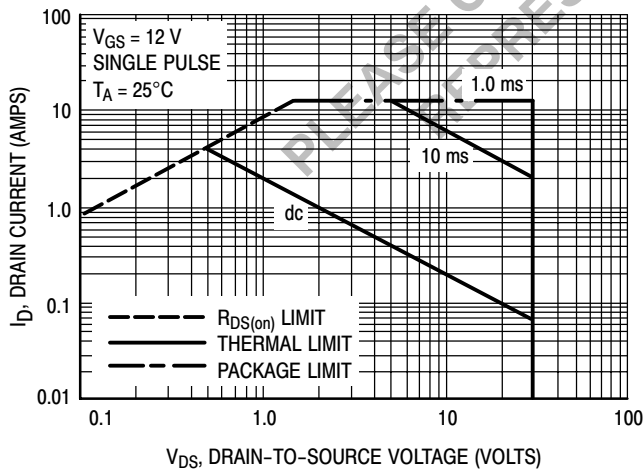

Figure 11. Maximum Rated Forward Biased Safe Operating Area

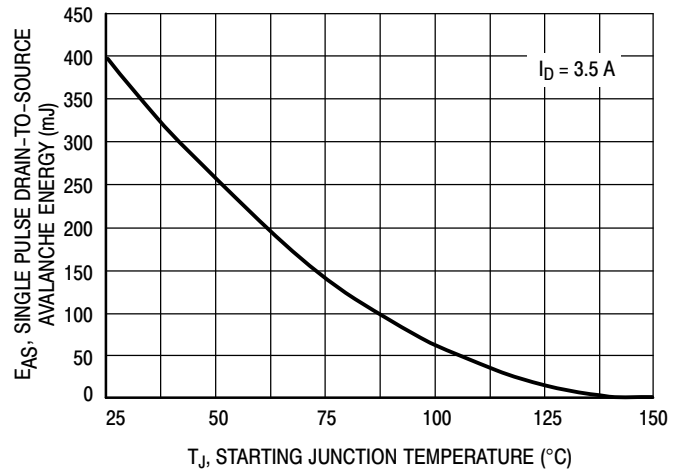

Figure 12. Maximum Avalanche Energy versus Starting Junction Temperature

MMDFS3P303

TYPICAL FET ELECTRICAL CHARACTERISTICS

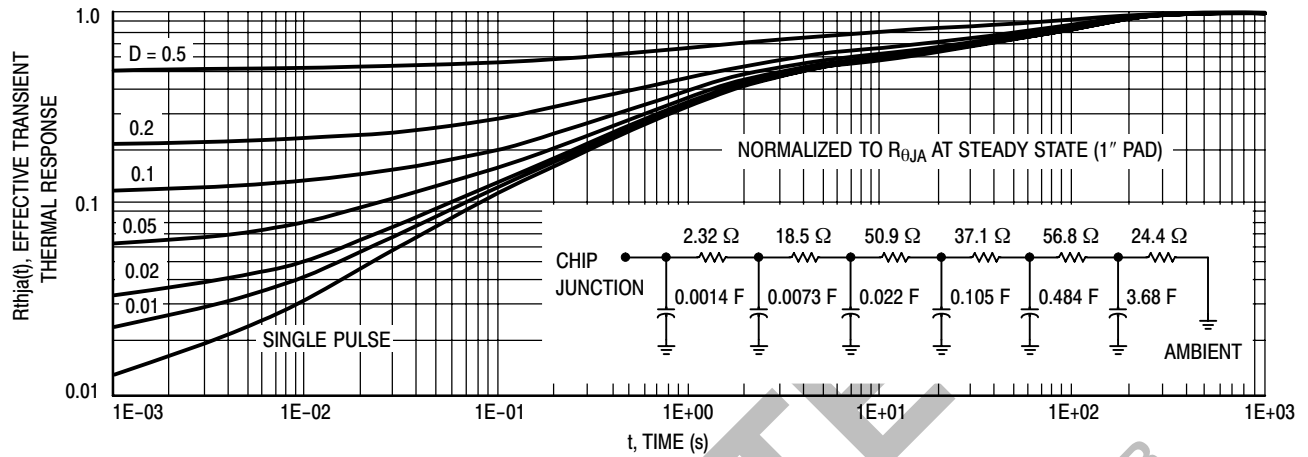

Figure 13. FET Thermal Response

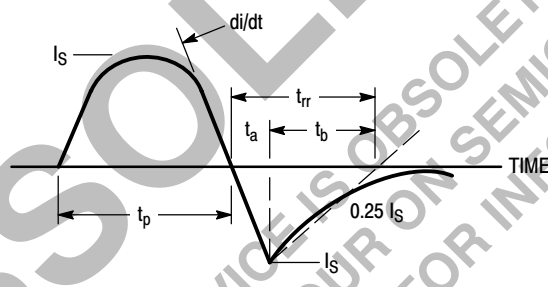

Figure 14. Diode Reverse Recovery Waveform

TYPICAL SCHOTTKY ELECTRICAL CHARACTERISTICS

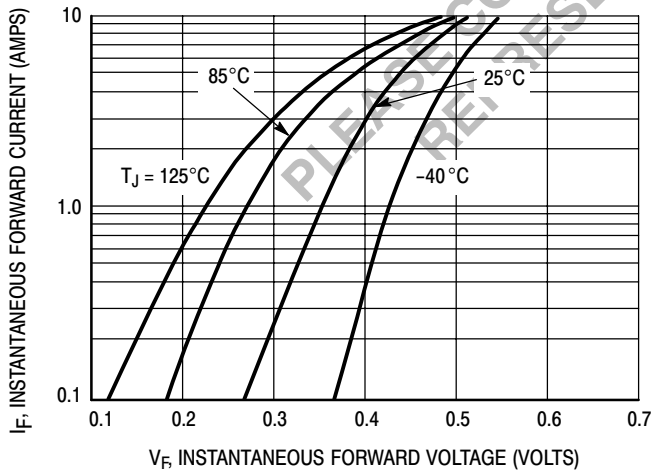

Figure 15. Typical Forward Voltage

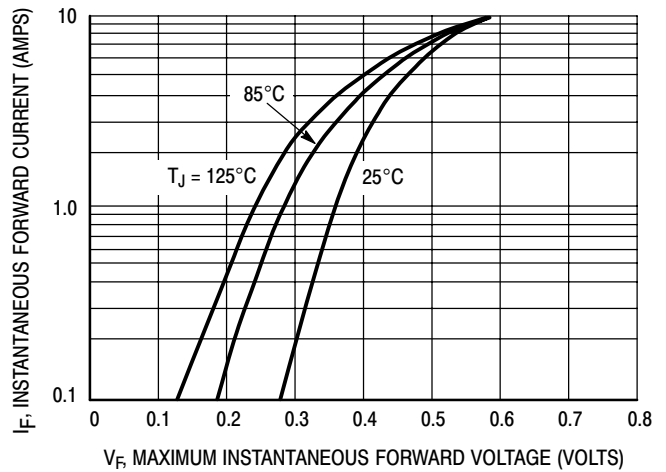

Figure 16. Maximum Forward Voltage

MMDFS3P303

TYPICAL SCHOTTKY ELECTRICAL CHARACTERISTICS

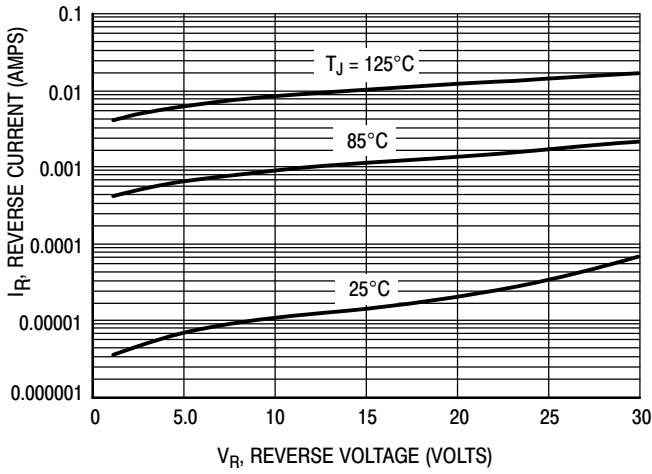

Figure 17. Typical Reverse Current

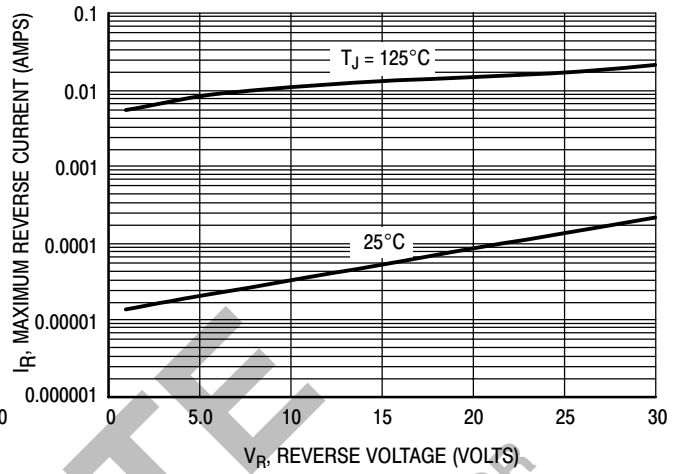

Figure 18. Maximum Reverse Current

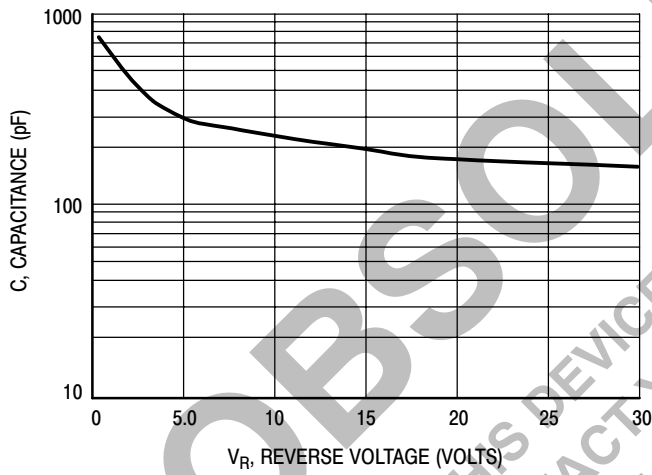

Figure 19. Typical Capacitance

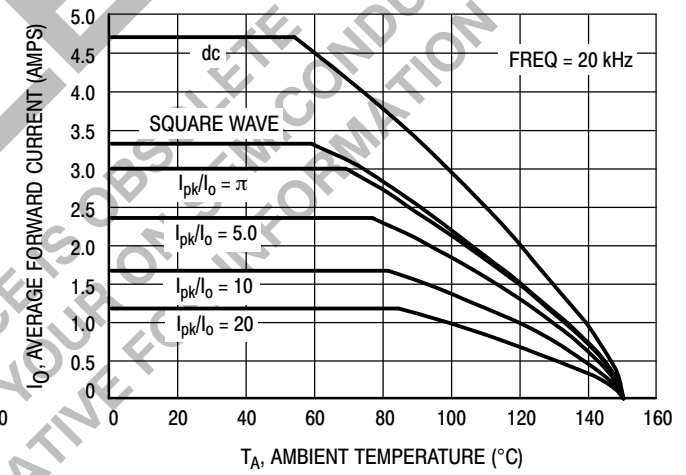

Figure 20. Current Derating

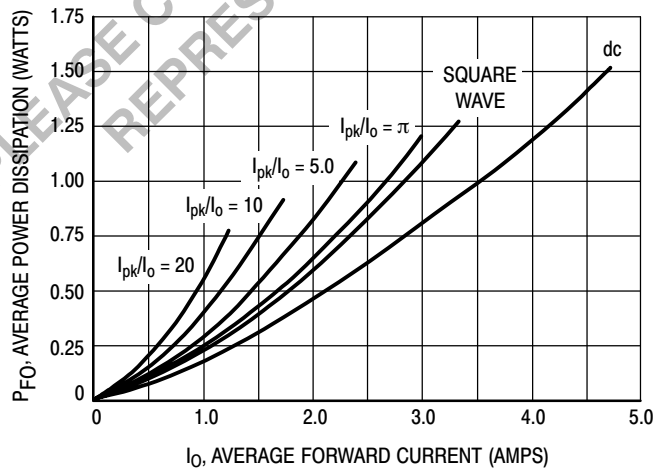

Figure 21. Forward Power Dissipation

TYPICAL SCHOTTKY ELECTRICAL CHARACTERISTICS

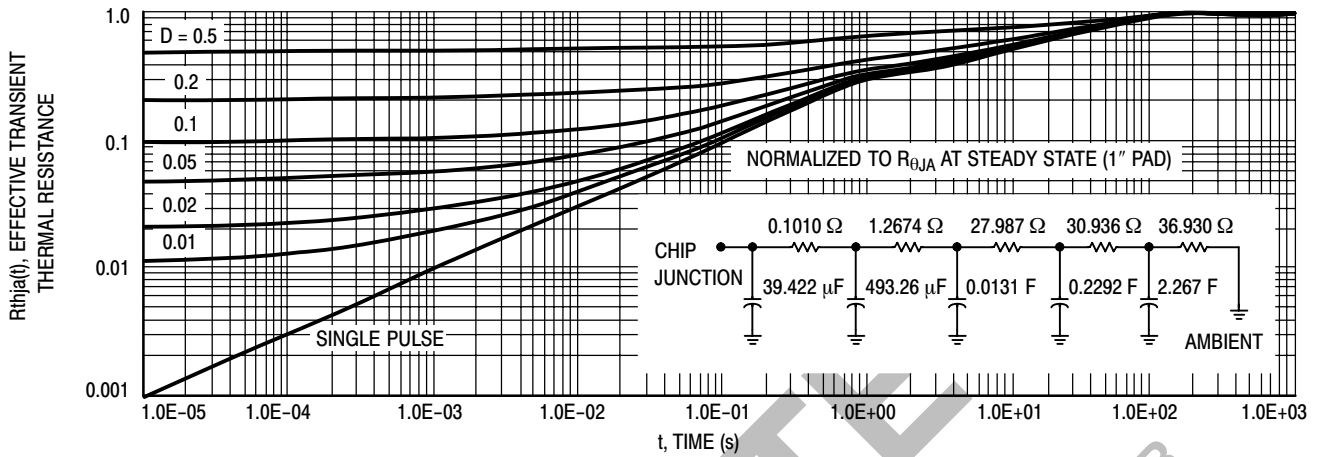
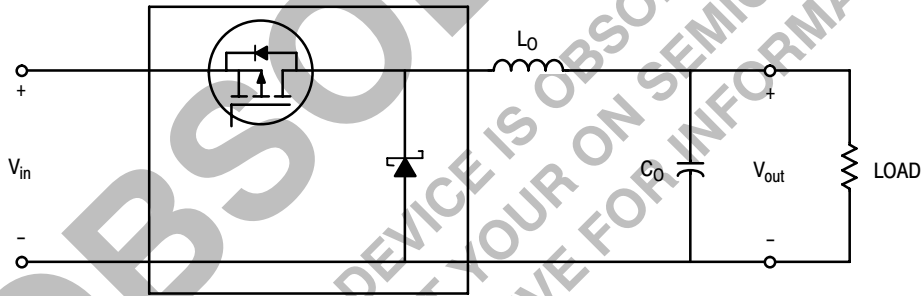

Figure 22. Schottky Thermal Response

TYPICAL APPLICATIONS

STEP DOWN SWITCHING REGULATORS



Buck Regulator

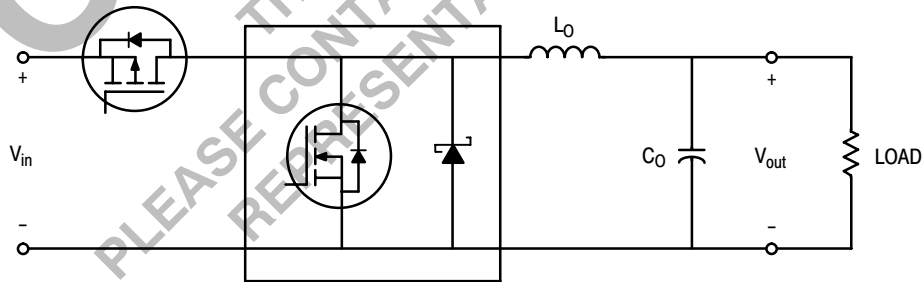

Synchronous Buck Regulator

MMDFS3P303

TYPICAL APPLICATIONS

STEP UP SWITCHING REGULATORS

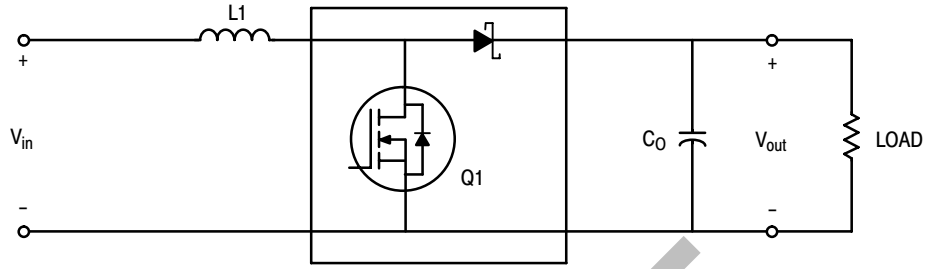

Boost Regulator

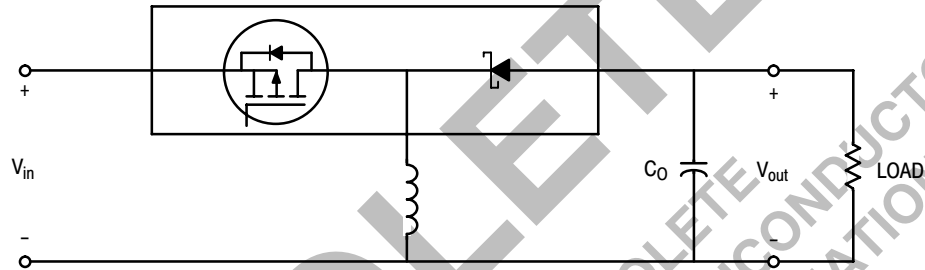

Buck-Boost Regulator

MULTIPLE BATTERY CHARGERS

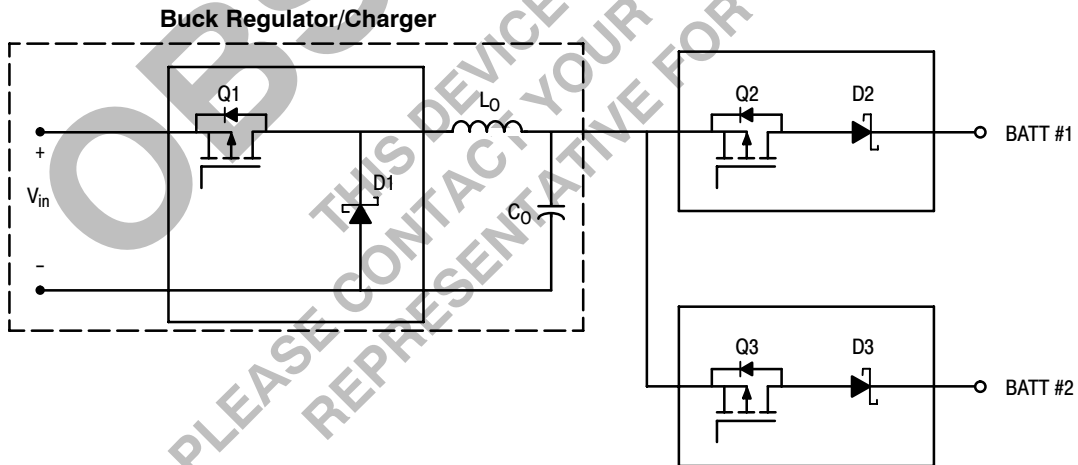

PLEASE CONTACT YOUR ONSEMI CONDUCTOR REPRESENTATIVE FOR INFORMATION

MMDFS3P303

TYPICAL APPLICATIONS

Li-Ion BATTERY PACK APPLICATIONS

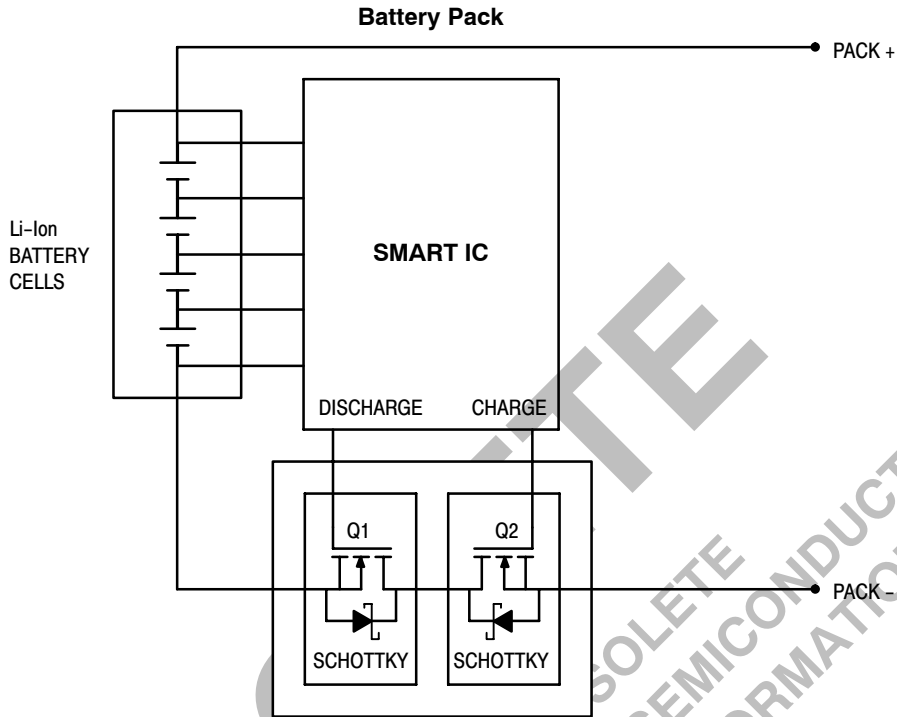

- Applicable in battery packs which require a high current level.
- During charge cycle Q2 is on and Q1 is off. Schottky can reduce power loss during fast charge.
- During discharge Q1 is on and Q2 is off. Again, Schottky can reduce power dissipation.
- Under normal operation, both transistors are on.

SO-8 FOOTPRINT

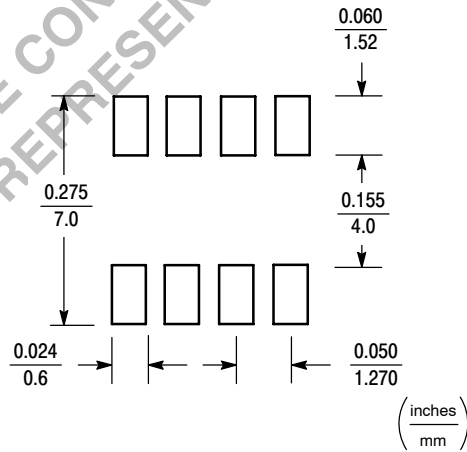

MMDFS3P303

PACKAGE DIMENSIONS

SO-8
CASE 751-07
ISSUE V

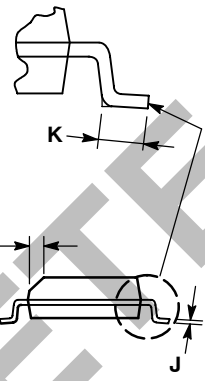
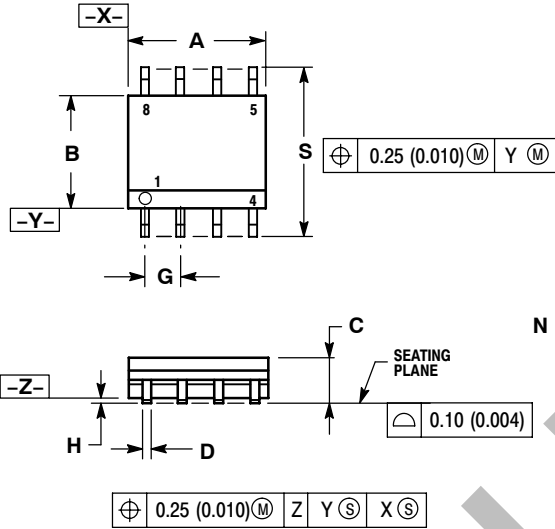

NOTES:

1. DIMENSIONING AND TOLERANCING PER ANSI Y14.5M, 1982.
2. CONTROLLING DIMENSION: MILLIMETER.
3. DIMENSION A AND B DO NOT INCLUDE MOLD PROTRUSION.
4. MAXIMUM MOLD PROTRUSION 0.15 (0.006) PER SIDE.
5. DIMENSION D DOES NOT INCLUDE DAMBAR PROTRUSION. ALLOWABLE DAMBAR PROTRUSION SHALL BE 0.127 (0.005) TOTAL IN EXCESS OF THE D DIMENSION AT MAXIMUM MATERIAL CONDITION.

DIM	MILLIMETERS		INCHES	
	MIN	MAX	MIN	MAX
A	4.80	5.00	0.189	0.197
B	3.80	4.00	0.150	0.157
C	1.35	1.75	0.053	0.069
D	0.33	0.51	0.013	0.020
G	1.27 BSC		0.050 BSC	
H	0.10	0.25	0.004	0.010
J	0.19	0.25	0.007	0.010
K	0.40	1.27	0.016	0.050
M	0°	8°	0°	8°
N	0.25	0.50	0.010	0.020
S	5.80	6.20	0.228	0.244

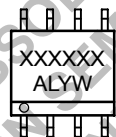

STYLE 18:

1. ANODE
2. ANODE
3. SOURCE
4. GATE
5. DRAIN
6. DRAIN
7. CATHODE
8. CATHODE

OBSOLETE
THIS DEVICE IS OBSOLETE
PLEASE CONTACT YOUR ON SEMICONDUCTOR SALES REPRESENTATIVE FOR INFORMATION

FETKY is a trademark of International Rectifier Corporation.

ON Semiconductor and **ON** are registered trademarks of Semiconductor Components Industries, LLC (SCILLC). SCILLC reserves the right to make changes without further notice to any products herein. SCILLC makes no warranty, representation or guarantee regarding the suitability of its products for any particular purpose, nor does SCILLC assume any liability arising out of the application or use of any product or circuit, and specifically disclaims any and all liability, including without limitation special, consequential or incidental damages. "Typical" parameters which may be provided in SCILLC data sheets and/or specifications can and do vary in different applications and actual performance may vary over time. All operating parameters, including "Typicals" must be validated for each customer application by customer's technical experts. SCILLC does not convey any license under its patent rights nor the rights of others. SCILLC products are not designed, intended, or authorized for use as components in systems intended for surgical implant into the body, or other applications intended to support or sustain life, or for any other application in which the failure of the SCILLC product could create a situation where personal injury or death may occur. Should Buyer purchase or use SCILLC products for any such unintended or unauthorized application, Buyer shall indemnify and hold SCILLC and its officers, employees, subsidiaries, affiliates, and distributors harmless against all claims, costs, damages, and expenses, and reasonable attorney fees arising out of, directly or indirectly, any claim of personal injury or death associated with such unintended or unauthorized use, even if such claim alleges that SCILLC was negligent regarding the design or manufacture of the part. SCILLC is an Equal Opportunity/Affirmative Action Employer. This literature is subject to all applicable copyright laws and is not for resale in any manner.

PUBLICATION ORDERING INFORMATION

LITERATURE FULFILLMENT:
Literature Distribution Center for ON Semiconductor
P.O. Box 5163, Denver, Colorado 80217 USA
Phone: 303-675-2175 or 800-344-3860 Toll Free USA/Canada
Fax: 303-675-2176 or 800-344-3867 Toll Free USA/Canada
Email: orderlit@onsemi.com

N. American Technical Support: 800-282-9855 Toll Free USA/Canada
Europe, Middle East and Africa Technical Support:
Phone: 421 33 790 2910
Japan Customer Focus Center
Phone: 81-3-5773-3850

ON Semiconductor Website: www.onsemi.com
Order Literature: <http://www.onsemi.com/orderlit>

For additional information, please contact your local Sales Representative