

Customer Part:

Description

- Standard 1.6 x 1.2mm SMD crystal in a hermetically sealed ceramic package with a sealed metal lid
- Model IQXC-26
- Model Issue number 4

Frequency Parameters

- Frequency 32.0MHz
- Frequency Tolerance ±15.00ppm
- Tolerance Condition @ 25°C
- Frequency Stability ±15.00ppm
- Operating Temperature Range -20.00 to 70.00°C
- Overtone Order Fundamental
- Ageing ±5ppm max per year @ 25°C

Electrical Parameters

- Load Capacitance (CL) 8.00pF
- Shunt Capacitance (C0) 7pF max
- Drive Level 100µW max
- ESR 100.00Ω max

Environmental Parameters

- Storage Temperature Range: -40 to 85°C
- Shock: IEC 60068-2-27: 1000G, 1ms, 3 times in each of 3 mutually perpendicular planes
- Vibration: IEC 60068-2-6: 1.5mm amplitude, 10Hz-55Hz, 1min in 3 mutually perpendicular planes, duration 2hrs each plane (total 6hrs)

Compliance

- RoHS Status (2015/863/EU) Compliant
- REACH Status Compliant
- MSL Rating (JDEC-STD-033): Not Applicable

Packaging Details

- Pack Style: Reel Tape & reel in accordance with EIA-481-D
Pack Size: 3,000
- *Alternative packing option available*

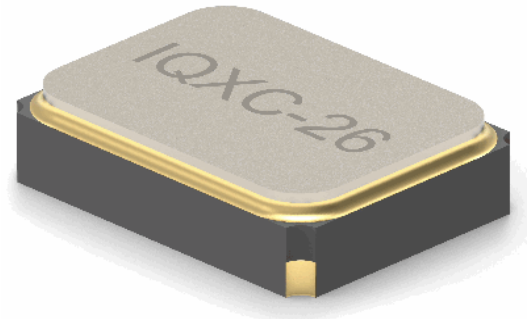

Outline (mm)

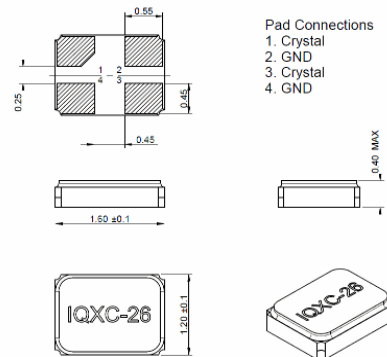

NOTE: The pad style on the base of the device may differ slightly from the drawing. The chamfer may appear on pad 1 or 4. This causes no change to the electrical performance of the device.

Recommended Solder Pad Layout

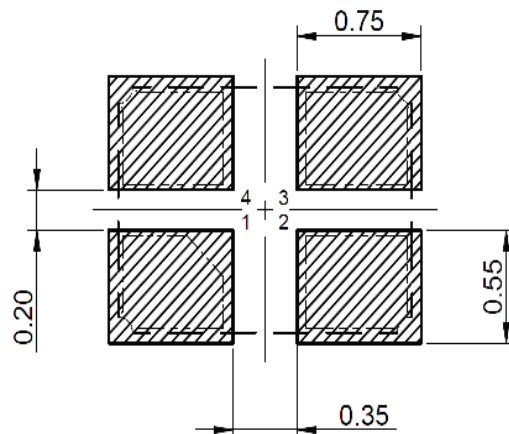

Sales Office Contact Details:

UK: +44 (0)1460 270200
Germany: 0800 1808 443

France: 0800 901 383
USA: +1.760.318.2824

Email: info@iqdfrequencyproducts.com
Web: www.iqdfrequencyproducts.com