



# Bridgelux® Gen 7 V8 Array

Product Data Sheet DS104



# Introduction

V Series



The V Series™ LED array products deliver high quality light in a compact and cost-effective solid state lighting package. These chip-on-board (CoB) arrays can be efficiently driven at twice the nominal drive current, enabling design flexibility not previously possible. This high flux density light source is designed to support a wide range of high quality, low cost directional luminaires and replacement lamps for commercial and residential applications.

The V8 LED array is available in a variety of CCT and CRI combinations providing substantial design flexibility and energy efficiencies.

Lighting system designs incorporating these LED arrays deliver increased system level efficacy and longer service life. Typical lighting applications include, but are not limited to, replacement lamps, accent, spot, track, down light, wide area, security, and wall pack.

## Features

- Efficacy of 155 lm/W typical for 3000K, 80 CRI
- Compact high flux density light source
- Uniform, high quality illumination
- Minimum 70, 80, and 90 CRI options
- Streamlined thermal path
- ENERGY STAR® / ANSI compliant color binning structure with 3 SDCM standard
- More energy efficient than incandescent, halogen and fluorescent lamps
- Low voltage DC operation
- Instant light with unlimited dimming
- V<sub>f</sub> bin code backside marking

## Benefits

- Enhanced optical control
- Clean white light without pixilation
- High quality, true color reproduction
- Significantly reduced thermal resistance and increased operating temperatures
- Uniform, consistent white light
- Lower operating costs
- Easy to use with daylight and motion detectors to enable increased energy savings
- Reduced maintenance costs
- Environmentally friendly, no disposal issues



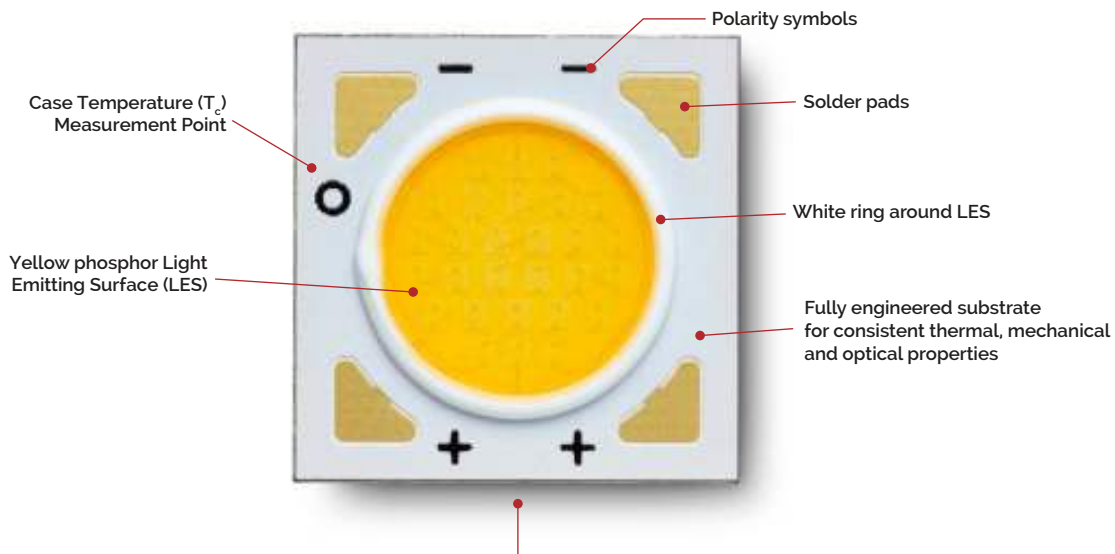
# Contents

Product Feature Map	2
Product Nomenclature	2
Product Selection Guide	3
Performance at Commonly Used Drive Currents	5
Electrical Characteristics	7
Eye Safety	8
Absolute Maximum Ratings	9
Performance Curves	10
Typical Color Spectrum	12
Typical Radiation Pattern	13
Mechanical Dimensions	14
Color Binning Information	15
Packaging and Labeling	16
Design Resources	18
Precautions	18
Disclaimers	18
About Bridgelux	19

# Product Feature Map

Bridgelux arrays are fully engineered devices that provide consistent thermal and optical performance on an engineered mechanical platform. The V Series arrays are the most compact CoB devices across all of

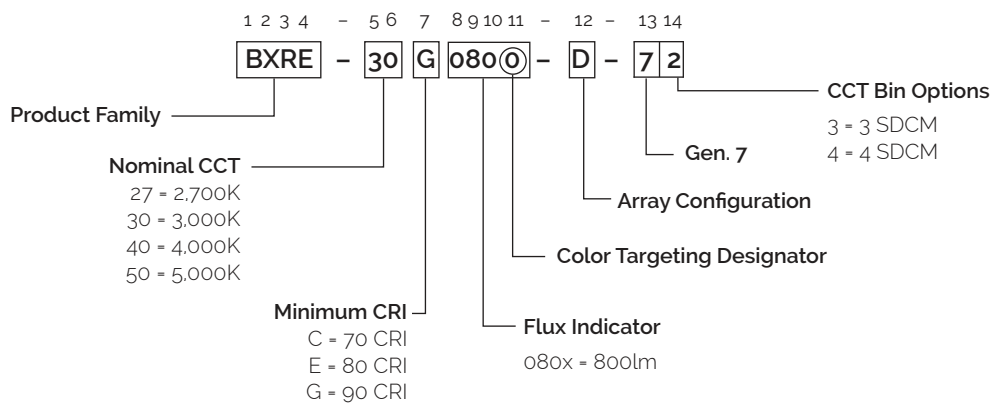
Bridgelux's LED Array products. The arrays incorporate several features to simplify design integration and assembly. Please visit [www.bridgelux.com](http://www.bridgelux.com) for more information on the V Series family of products.



Note: Part number and lot codes are scribed on back of array

## Product Nomenclature

The part number designation for Bridgelux V Series LED arrays is explained as follows:



# Product Selection Guide

The following product configurations are available:

**Table 1:** Selection Guide, Pulsed Measurement Data ( $T_j = T_c = 25^\circ\text{C}$ )

Part Number	Nominal CCT <sup>1</sup> (K)	CRI <sup>2</sup>	Nominal Drive Current <sup>3</sup> (mA)	Typical Pulsed Flux <sup>4,5,6</sup> $T_c = 25^\circ\text{C}$ (lm)	Minimum Pulsed Flux <sup>6,7</sup> $T_c = 25^\circ\text{C}$ (lm)	Typical $V_f$ (V)	Typical Power (W)	Typical Efficacy (lm/W)
BXRE-27E0800-D-73	2700	80	350	896	789	17.3	6.1	148
BXRE-27E0800-E-73	2700	80	175	899	791	34.7	6.1	148
BXRE-27G0800-D-73	2700	90	350	751	661	17.3	6.1	124
BXRE-27G0800-E-73	2700	90	175	753	663	34.7	6.1	124
BXRE-30E0800-D-73	3000	80	350	939	826	17.3	6.1	155
BXRE-30E0800-E-73	3000	80	175	941	828	34.7	6.1	155
BXRE-30G0800-D-73	3000	90	350	781	687	17.3	6.1	129
BXRE-30G0800-E-73	3000	90	175	783	689	34.7	6.1	129
BXRE-40E0800-D-73	4000	80	350	975	858	17.3	6.1	161
BXRE-40E0800-E-73	4000	80	175	978	860	34.7	6.1	161
BXRE-40G0800-D-73	4000	90	350	836	735	17.3	6.1	138
BXRE-40G0800-E-73	4000	90	175	838	737	34.7	6.1	138
BXRE-50C0800-D-74	5000	70	350	1066	938	17.3	6.1	176
BXRE-50C0800-E-74	5000	70	175	1069	941	34.7	6.1	176

Notes for Table 1:

- Nominal CCT as defined by ANSI C78.377-2011.
- CRI values are minimums and tested at  $T_j = T_c = 25^\circ\text{C}$ . Minimum Rg value for 80 CRI products is 0, the minimum Rg values for 90 CRI products is 50.
- Drive current is referred to as nominal drive current.
- Products tested under pulsed condition (10ms pulse width) at nominal test current where  $T_j$  (junction temperature) =  $T_c$  (case temperature) =  $25^\circ\text{C}$ .
- Typical performance values are provided as a reference only and are not a guarantee of performance.
- Bridgelux maintains a  $\pm 7\%$  tolerance on flux measurements.
- Minimum flux values at the nominal test current are guaranteed by 100% test.

# Product Selection Guide

**Table 2:** Selection Guide, Stabilized DC Performance ( $T_c = 85^\circ\text{C}$ )

Part Number	Nominal CCT <sup>1</sup> (K)	CRI <sup>2</sup>	Nominal Drive Current <sup>3</sup> (mA)	Typical DC Flux <sup>4,5</sup> $T_c = 85^\circ\text{C}$ (lm)	Minimum DC Flux <sup>6</sup> $T_c = 85^\circ\text{C}$ (lm)	Typical $V_f$ (V)	Typical Power (W)	Typical Efficacy (lm/W)
BXRE-27E0800-D-73	2700	80	350	807	710	16.7	5.8	138
BXRE-27E0800-E-73	2700	80	175	809	712	33.4	5.9	138
BXRE-27G0800-D-73	2700	90	350	676	595	16.7	5.8	116
BXRE-27G0800-E-73	2700	90	175	678	596	33.4	5.9	116
BXRE-30E0800-D-73	3000	80	350	845	743	16.7	5.8	145
BXRE-30E0800-E-73	3000	80	175	847	745	33.4	5.9	145
BXRE-30G0800-D-73	3000	90	350	703	619	16.7	5.8	120
BXRE-30G0800-E-73	3000	90	175	705	620	33.4	5.9	120
BXRE-40E0800-D-73	4000	80	350	877	772	16.7	5.8	150
BXRE-40E0800-E-73	4000	80	175	880	774	33.4	5.9	150
BXRE-40G0800-D-73	4000	90	350	752	662	16.7	5.8	129
BXRE-40G0800-E-73	4000	90	175	754	664	33.4	5.9	129
BXRE-50C0800-D-74	5000	70	350	959	844	16.7	5.8	164
BXRE-50C0800-E-74	5000	70	175	962	846	33.4	5.9	164

Notes for Table 2:

1. Nominal CCT as defined by ANSI C78.377-2011.
2. CRI values are minimums and tested at  $T_j = T_c = 25^\circ\text{C}$ . Minimum Rg value for 80 CRI products is 0, the minimum Rg values for 90 CRI products is 50.
3. Drive current is referred to as nominal drive current.
4. Typical stabilized DC performance values are provided as reference only and are not a guarantee of performance.
5. Typical performance is estimated based on operation under DC (direct current) with LED array mounted onto a heat sink with thermal interface material and the case temperature maintained at  $85^\circ\text{C}$ . Based on Bridgelux test setup, values may vary depending on the thermal design of the luminaire and/or the exposed environment to which the product is subjected.
6. Minimum flux values at elevated temperatures are provided for reference only and are not guaranteed by 100% production testing. Based on Bridgelux test setup, values may vary depending on the thermal design of the luminaire and/or the exposed environment to which the product is subjected.

# Performance at Commonly Used Drive Currents

V Series LED arrays are tested to the specifications shown using the nominal drive currents in Table 1. V Series may also be driven at other drive currents dependent on specific application design requirements. The performance at any drive current can be derived from the current vs. voltage characteristics shown in Figures 1 and 2 and the flux vs. current characteristics shown in Figure 3 and 4. The performance at commonly used drive currents is summarized in Table 3.

**Table 3:** Product Performance at Commonly Used Drive Currents

Part Number	CRI	Drive Current <sup>1</sup> (mA)	Typical $V_f$ $T_c = 25^\circ\text{C}$ (V)	Typical Power $T_c = 25^\circ\text{C}$ (W)	Typical Flux <sup>2</sup> $T_c = 25^\circ\text{C}$ (lm)	Typical DC Flux <sup>3</sup> $T_c = 85^\circ\text{C}$ (lm)	Typical Efficacy $T_c = 25^\circ\text{C}$ (lm/W)
BXRE-27E0800-D-73	80	175	16.6	2.9	462	416	159
		250	16.9	4.2	651	586	154
		<b>350</b>	<b>17.3</b>	<b>6.1</b>	<b>896</b>	<b>807</b>	<b>148</b>
		500	17.8	8.9	1244	1120	140
		700	18.4	12.9	1676	1509	130
BXRE-27E0800-E-73	80	88	33.0	2.9	465	419	160
		125	33.9	4.2	655	589	155
		<b>175</b>	<b>34.7</b>	<b>6.1</b>	<b>899</b>	<b>809</b>	<b>148</b>
		250	35.5	8.9	1247	1122	140
		350	36.8	12.9	1682	1514	131
BXRE-27G0800-D-73	90	175	16.6	2.9	387	349	133
		250	16.9	4.2	546	491	129
		<b>350</b>	<b>17.3</b>	<b>6.1</b>	<b>751</b>	<b>676</b>	<b>124</b>
		500	17.8	8.9	1042	938	117
		700	18.4	12.9	1405	1264	109
BXRE-27G0800-E-73	90	88	33.0	2.9	390	351	134
		125	33.9	4.2	549	494	129
		<b>175</b>	<b>34.7</b>	<b>6.1</b>	<b>753</b>	<b>678</b>	<b>124</b>
		250	35.5	8.9	1045	940	118
		350	36.8	12.9	1410	1269	109
BXRE-30E0800-D-73	80	175	16.6	2.9	484	436	167
		250	16.9	4.2	682	614	161
		<b>350</b>	<b>17.3</b>	<b>6.1</b>	<b>939</b>	<b>845</b>	<b>155</b>
		500	17.8	8.9	1303	1173	146
		700	18.4	12.9	1756	1580	136
BXRE-30E0800-E-73	80	88	33.0	2.9	487	439	168
		125	33.9	4.2	686	617	162
		<b>175</b>	<b>34.7</b>	<b>6.1</b>	<b>941</b>	<b>847</b>	<b>155</b>
		250	35.5	8.9	1306	1175	147
		350	36.8	12.9	1762	1586	137

Notes for Table 3:

1. Alternate drive currents in Table 3 are provided for reference only and are not a guarantee of performance.
2. Bridgelux maintains a  $\pm 7\%$  tolerance on flux measurements.
3. Typical stabilized DC performance values are provided as reference only and are not a guarantee of performance.

# Performance at Commonly Used Drive Currents

**Table 3:** Product Performance at Commonly Used Drive Currents (continued)

Part Number	CRI	Drive Current <sup>1</sup> (mA)	Typical V <sub>f</sub> T <sub>c</sub> = 25°C (V)	Typical Power T <sub>c</sub> = 25°C (W)	Typical Flux <sup>2</sup> T <sub>c</sub> = 25°C (lm)	Typical DC Flux <sup>3</sup> T <sub>c</sub> = 85°C (lm)	Typical Efficacy T <sub>c</sub> = 25°C (lm/W)
BXRE-30G0800-D-73	90	175	16.6	2.9	403	363	139
		250	16.9	4.2	568	511	134
		<b>350</b>	<b>17.3</b>	<b>6.1</b>	<b>781</b>	<b>703</b>	<b>129</b>
		500	17.8	8.9	1084	976	122
		700	18.4	12.9	1461	1315	113
BXRE-30G0800-E-73	90	88	33.0	2.9	406	365	140
		125	33.9	4.2	571	514	135
		<b>175</b>	<b>34.7</b>	<b>6.1</b>	<b>783</b>	<b>705</b>	<b>129</b>
		250	35.5	8.9	1087	978	122
		350	36.8	12.9	1466	1320	114
BXRE-40E0800-D-73	80	175	16.6	2.9	503	453	173
		250	16.9	4.2	709	638	168
		<b>350</b>	<b>17.3</b>	<b>6.1</b>	<b>975</b>	<b>877</b>	<b>161</b>
		500	17.8	8.9	1353	1218	152
		700	18.4	12.9	1824	1641	141
BXRE-40E0800-E-73	80	88	33.0	2.9	506	456	174
		125	33.9	4.2	712	641	168
		<b>175</b>	<b>34.7</b>	<b>6.1</b>	<b>978</b>	<b>880</b>	<b>161</b>
		250	35.5	8.9	1356	1221	153
		350	36.8	12.9	1830	1647	142
BXRE-40G0800-D-73	90	175	16.6	2.9	431	388	148
		250	16.9	4.2	607	547	144
		<b>350</b>	<b>17.3</b>	<b>6.1</b>	<b>836</b>	<b>752</b>	<b>138</b>
		500	17.8	8.9	1160	1044	130
		700	18.4	12.9	1563	1407	121
BXRE-40G0800-E-73	90	88	33.0	2.9	434	391	149
		125	33.9	4.2	611	550	144
		<b>175</b>	<b>34.7</b>	<b>6.1</b>	<b>838</b>	<b>754</b>	<b>138</b>
		250	35.5	8.9	1163	1046	131
		350	36.8	12.9	1569	1412	122
BXRE-50C0800-D-74	70	175	16.6	2.9	550	495	189
		250	16.9	4.2	775	697	183
		<b>350</b>	<b>17.3</b>	<b>6.1</b>	<b>1066</b>	<b>959</b>	<b>176</b>
		500	17.8	8.9	1480	1332	166
		700	18.4	12.9	1994	1794	154
BXRE-50C0800-E-74	70	88	33.0	2.9	553	498	191
		125	33.9	4.2	779	701	184
		<b>175</b>	<b>34.7</b>	<b>6.1</b>	<b>1069</b>	<b>962</b>	<b>176</b>
		250	35.5	8.9	1483	1334	167
		350	36.8	12.9	2001	1801	155

Notes for Table 3:

1. Alternate drive currents in Table 3 are provided for reference only and are not a guarantee of performance.
2. Bridgelux maintains a ± 7% tolerance on flux measurements.
3. Typical stabilized DC performance values are provided as reference only and are not a guarantee of performance.



# Electrical Characteristics

**Table 4:** Electrical Characteristics

Part Number	Drive Current (mA)	Forward Voltage Pulsed, $T_c = 25^\circ\text{C}$ (V) <sup>1, 2, 3, 8</sup>			Typical Coefficient of Forward Voltage <sup>4</sup> $\Delta V_f / \Delta T_c$ (mV/ $^\circ\text{C}$ )	Typical Thermal Resistance Junction to Case <sup>5,6</sup> $R_{j-c}$ ( $^\circ\text{C}/\text{W}$ )	Driver Selection Voltages <sup>7</sup> (V)	
		Minimum	Typical	Maximum			$V_f$ Min. Hot $T_c = 105^\circ\text{C}$ (V)	$V_f$ Max. Cold $T_c = -40^\circ\text{C}$ (V)
BXRE-xxx080x-D-7x	350	16.0	17.3	18.6	-7.38	0.75	15.4	19.1
	700	17.0	18.5	19.8	-7.38	0.88	16.4	20.3
BXRE-xxx080x-E-7x	175	32.0	34.7	37.2	-14.76	0.75	33.2	37.7
	350	34.1	36.9	39.7	-14.76	0.88	35.3	40.1

Notes for Table 4:

- Parts are tested in pulsed conditions,  $T_c = 25^\circ\text{C}$ . Pulse width is 10ms.
- Voltage minimum and maximum are provided for reference only and are not a guarantee of performance.
- Bridgelux maintains a tester tolerance of  $\pm 0.10\text{V}$  on forward voltage measurements.
- Typical coefficient of forward voltage tolerance is  $\pm 0.1\text{mV}$  for nominal current.
- Thermal resistance values are based from test data of a 3000K 80 CRI product.
- Thermal resistance value was calculated using total electrical input power; optical power was not subtracted from input power. The thermal interface material used during testing is not included in the thermal resistance value.
- $V_f$  min hot and max cold values are provided as reference only and are not guaranteed by test. These values are provided to aid in driver design and selection over the operating range of the product.
- This product has been designed and manufactured per IEC 62031:2014. This product has passed dielectric withstand voltage testing at 1160 V. The working voltage designated for the insulation is 80V d.c. The maximum allowable voltage across the array must be determined in the end product application.

# Eye Safety

**Table 5:** Eye Safety Risk Group (RG) Classifications

Part Number	Drive Current <sup>3</sup> (mA)	CCT <sup>1,3</sup>		
		2700K/3000K	4000K	5000K <sup>2</sup>
BXRE-xxx080x-D-7x	350	RG1	RG1	RG1
	500	RG1	RG1	RG2
	700	RG1	RG1	RG2
BXRE-xxx080x-E-7x	175	RG1	RG1	RG1
	250	RG1	RG1	RG2
	350	RG1	RG1	RG2

Notes for Table 5:

1. Eye safety classification for the use of Bridgelux V Series LED arrays is in accordance with specification IEC/TR 62778: Application of IEC 62471 for the assessment of blue light hazard to light sources and luminaires.
2. For products classified as RG2 at 5000K  $E_{thr} = 1315.8$  lx.
3. Please contact your Bridgelux sales representative for  $E_{thr}$  values at specific drive currents and CCTs not listed.

# Absolute Maximum Ratings

**Table 6:** Maximum Ratings

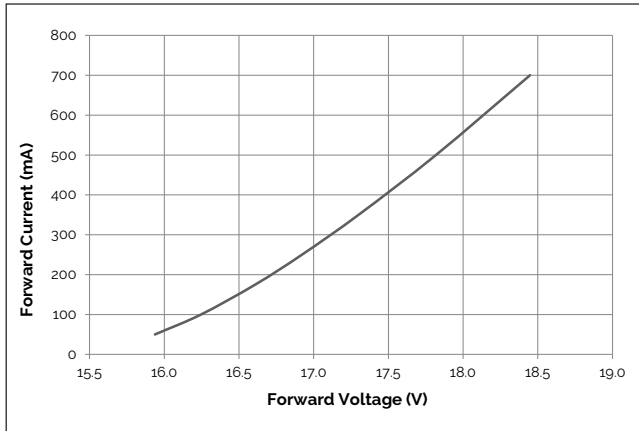
Parameter	Maximum Rating	
LED Junction Temperature (T <sub>j</sub> )	125°C	
Storage Temperature	-40°C to +105°C	
Operating Case Temperature <sup>1</sup> (T <sub>c</sub> )	105°C	
Soldering Temperature <sup>2</sup>	300°C or lower for a maximum of 6 seconds	
	BXRE-xxx080x-D-7x	BXRE-xxx080x-E-7x
Maximum Drive Current <sup>3</sup>	700mA	350mA
Maximum Peak Pulsed Drive Current <sup>4</sup>	1000mA	500mA
Maximum Reverse Voltage <sup>5</sup>	-35V	-60V

Notes for Table 6:

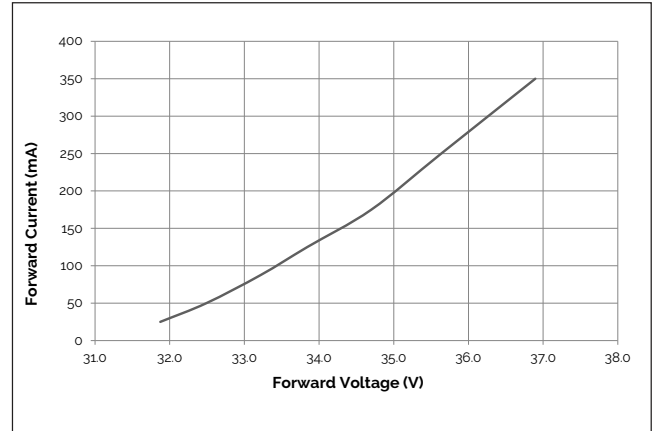
1. For IEC 62717 requirement, please consult your Bridgelux sales representative.
2. Refer to Bridgelux Application Note AN101: Handling and Assembly of Bridgelux V Series LED Arrays.
3. Arrays may be driven at higher currents however lumen maintenance may be reduced.
4. Bridgelux recommends a maximum duty cycle of 10% and pulse width of 20 ms when operating LED Arrays at maximum peak pulsed current specified. Maximum peak pulsed currents indicate values where LED Arrays can be driven without catastrophic failures.
5. Light emitting diodes are not designed to be driven in reverse voltage and will not produce light under this condition. Maximum rating provided for reference only.

# Performance Curves

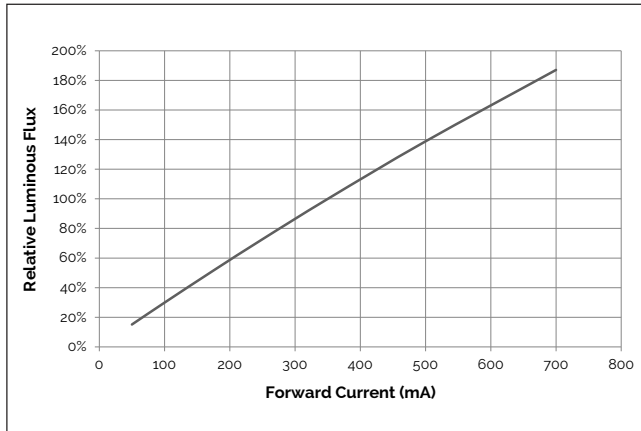
**Figure 1: V8D Drive Current vs. Voltage ( $T_j = T_c = 25^\circ\text{C}$ )<sup>1</sup>**



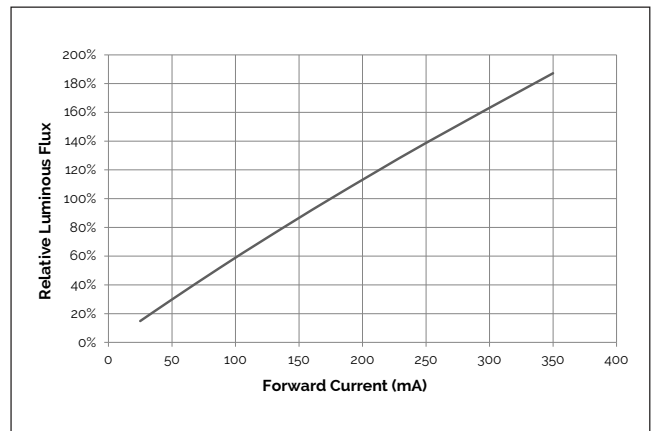
**Figure 2: V8E Drive Current vs. Voltage ( $T_j = T_c = 25^\circ\text{C}$ )<sup>1</sup>**



**Figure 3: V8D Typical Relative Luminous Flux vs. Drive Current ( $T_j = T_c = 25^\circ\text{C}$ )<sup>1</sup>**



**Figure 4: V8E Typical Relative Luminous Flux vs. Drive Current ( $T_j = T_c = 25^\circ\text{C}$ )<sup>1</sup>**

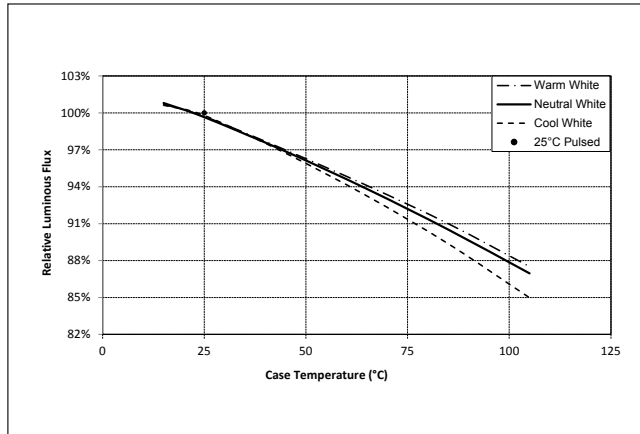


Notes for Figures 1 - 4:

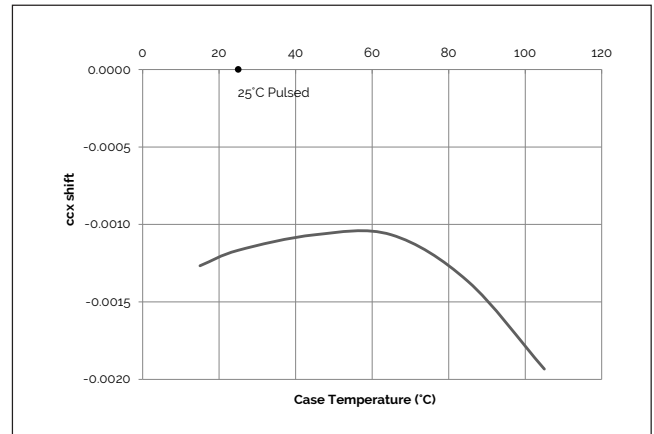
1. Bridgelux does not recommend driving high power LEDs at low currents. Doing so may produce unpredictable results. Pulse width modulation (PWM) is recommended for dimming effects.
2. Characteristics shown for 3000K and 90 CRI.

# Performance Curves

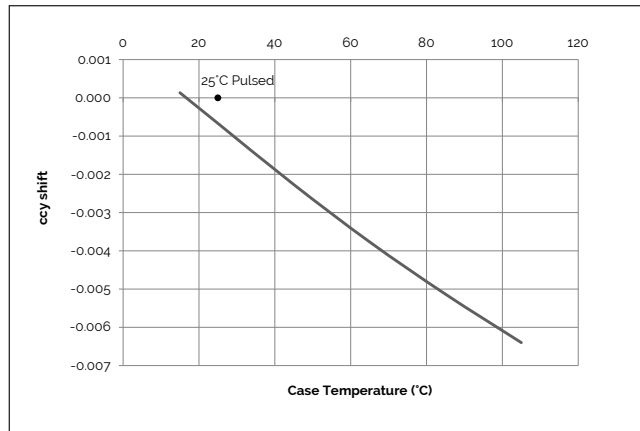
**Figure 5: Typical DC Flux vs. Case Temperature**



**Figure 6: Typical DC ccx Shift vs. Case Temperature**

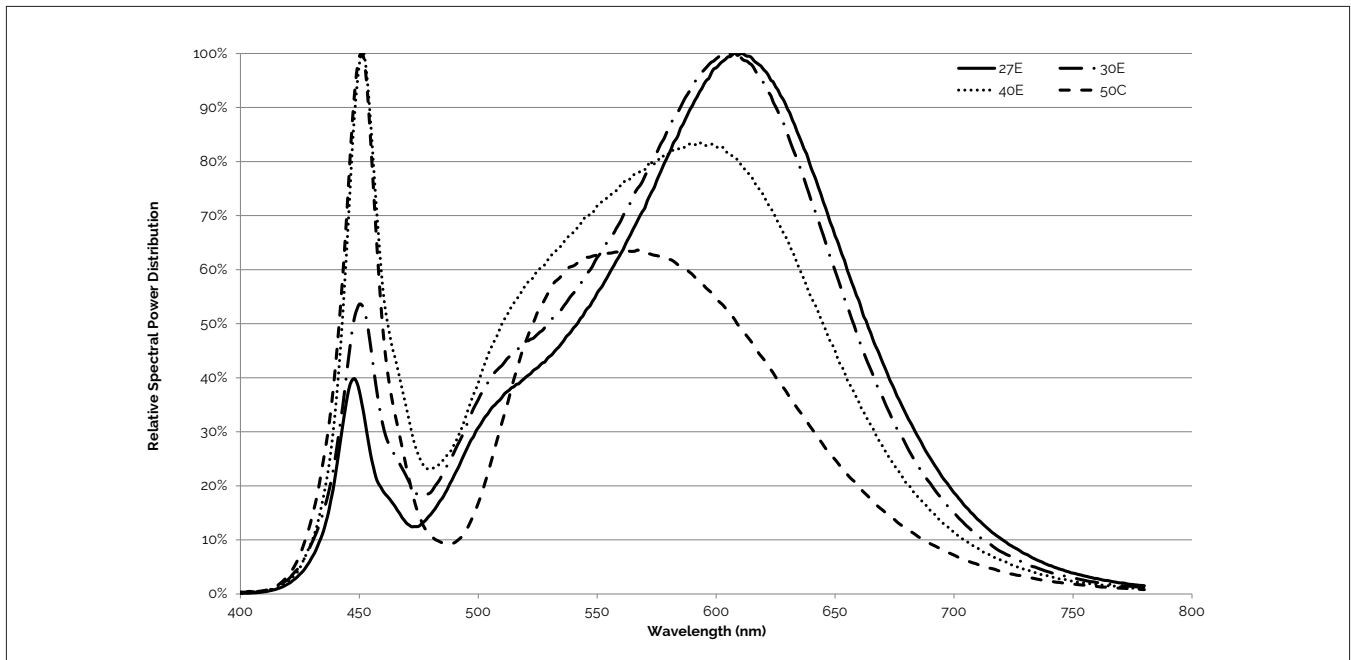


**Figure 7: Typical DC ccy Shift vs. Case Temperature**



# Typical Color Spectrum

Figure 8: Typical Color Spectrum

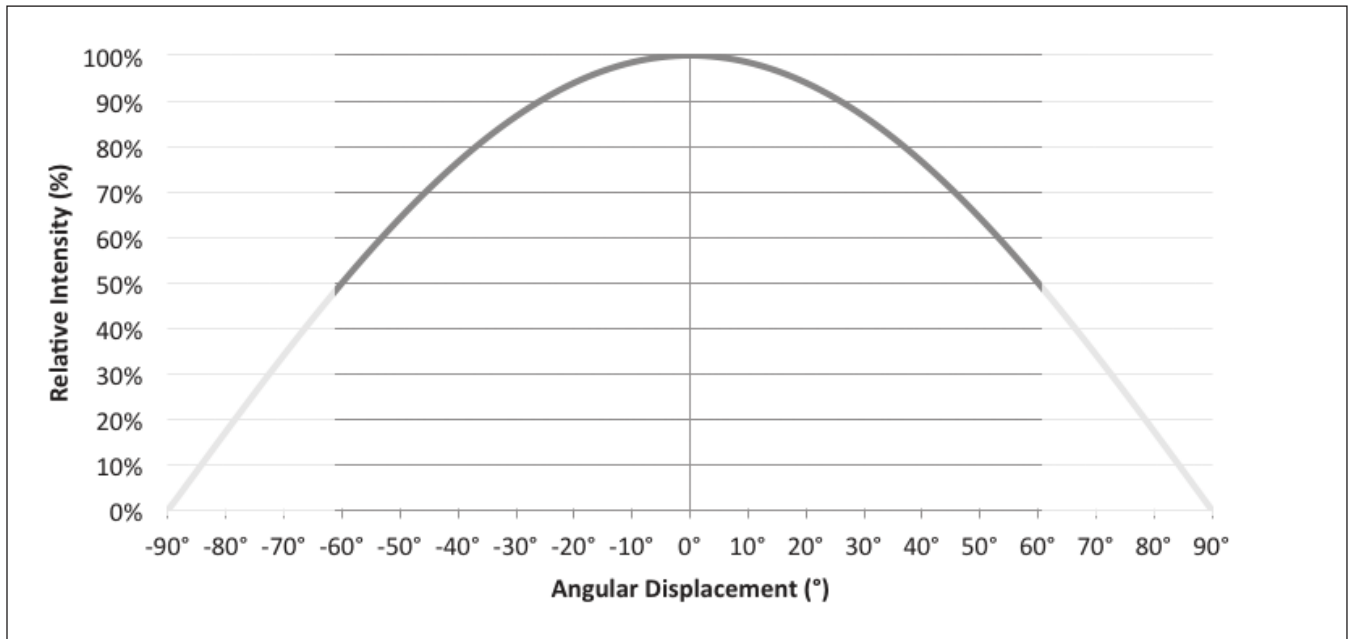


Note for Figure 8:

1. Color spectra measured at nominal current for  $T_j = T_c = 25^\circ\text{C}$ .
2. Color spectra shown is 3000K and 80 CRI.
3. Color spectra shown is 4000K and 80 CRI.
4. Color spectra shown is 5000K and 70 CRI.

# Typical Radiation Pattern

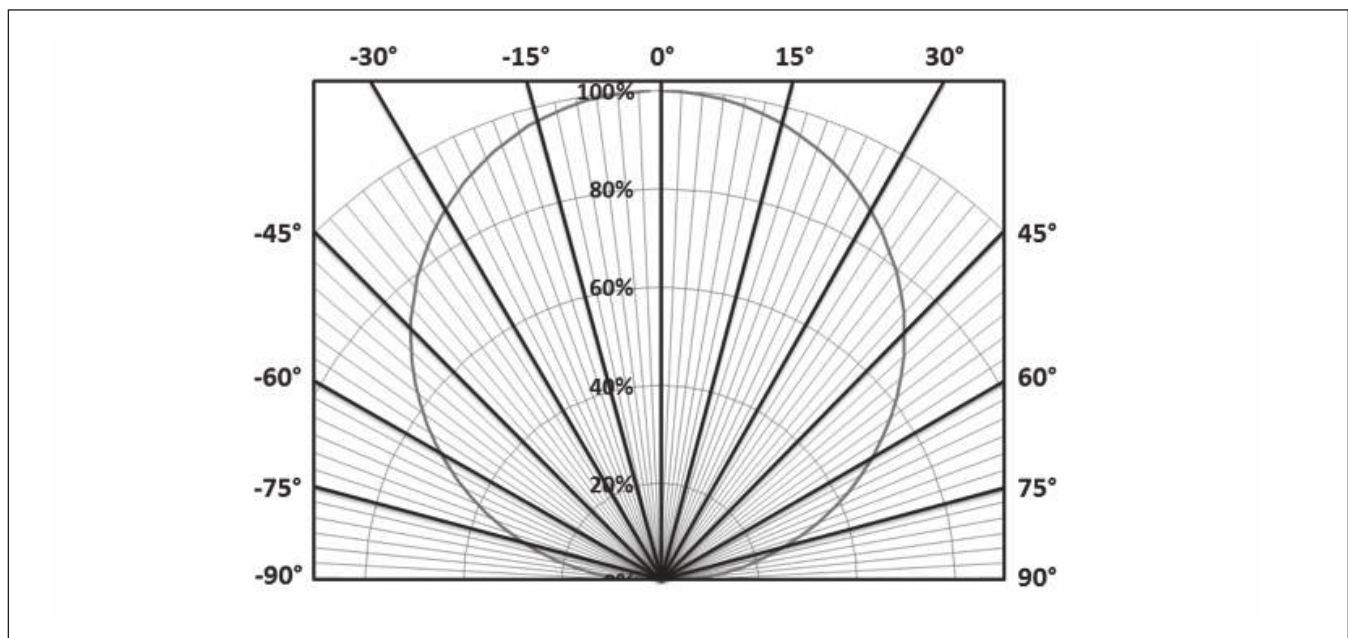
Figure 9: Typical Spatial Radiation Pattern



Note for Figure 9:

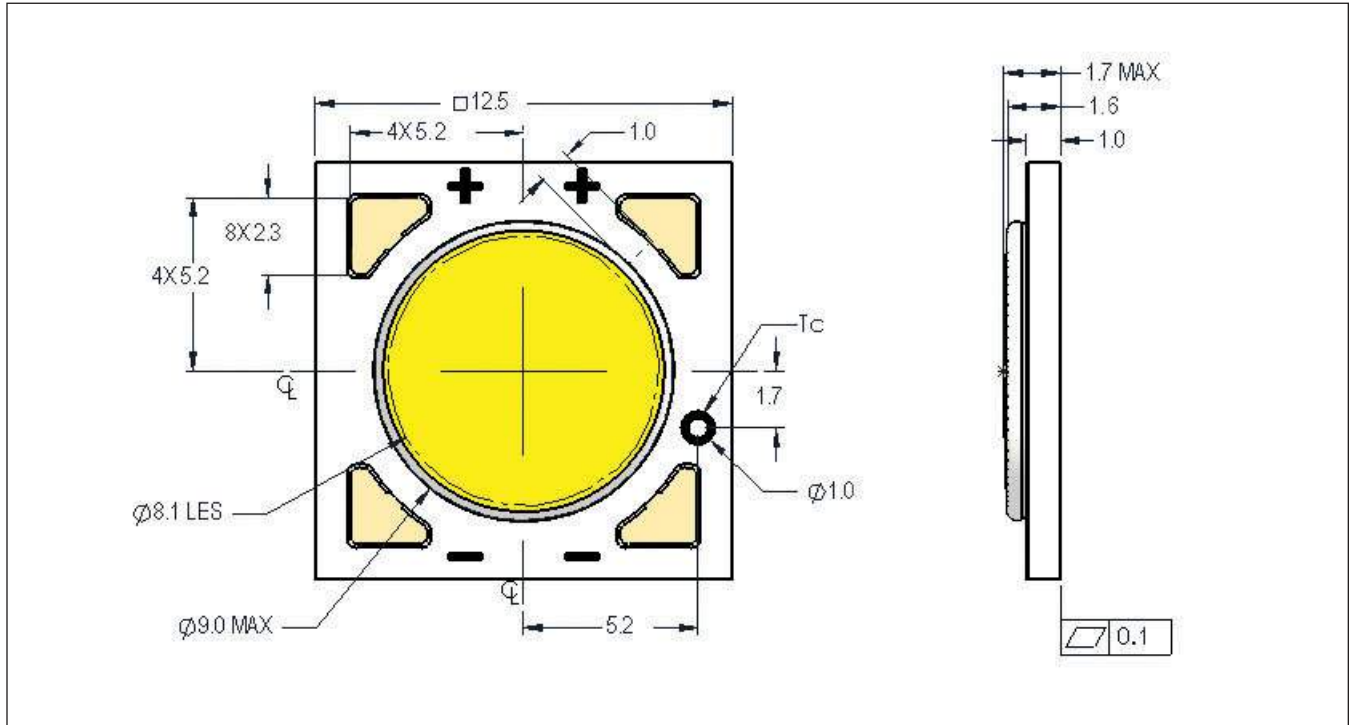
1. Typical viewing angle is 120°.
2. The viewing angle is defined as the off axis angle from the centerline where intensity is ½ of the peak value.

Figure 10: Typical Polar Radiation Pattern



# Mechanical Dimensions

**Figure 11: V8 LED Array**



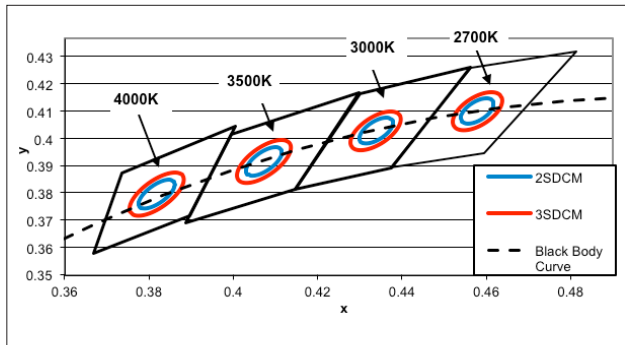
Notes for Figure 11:

1. Drawings are not to scale.
2. Drawing dimensions are in millimeters.
3. Solder pads are labeled "+" and "-" to denote positive and negative polarity, respectively.
4. Unless otherwise specified, tolerances are  $\pm 0.1\text{mm}$ .
5. Refer to Application Notes AN101 for product handling, mounting and heat sink recommendations.
6. The optical center of the LED Array is nominally defined by the mechanical center of the array to a tolerance of  $\pm 0.2\text{mm}$ .
7. Bridgelux maintains a flatness of 0.10mm across the mounting surface of the array.



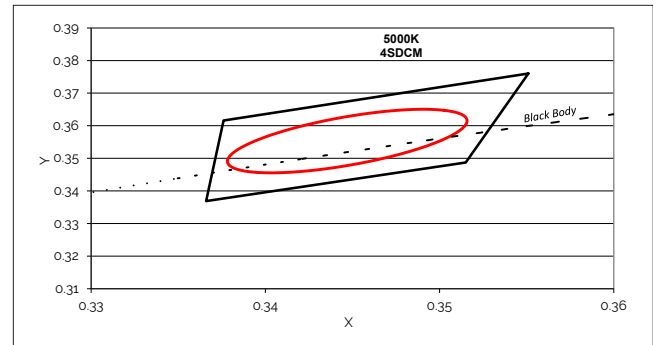
# Color Binning Information

**Figure 12: Graph of Warm and Neutral White Test Bins in xy Color Space**



Note: Pulsed Test Conditions,  $T_c = 25^\circ\text{C}$

**Figure 13: Graph of Cool White Test Bins in xy Color Space**



**Table 7: Warm and Neutral White xy Bin Coordinates and Associated Typical CCT**

Bin Code	2700K	3000K	3500K	4000K
ANSI Bin (for reference only)	(2580K - 2870K)	(2870K - 3220K)	(3220K - 3710K)	(3710K - 4260K)
72 (2 SDCM)	(2674K - 2769K)	(2995K - 3107K)	(3404K - 3548K)	(3895K - 4081K)
73 (3 SDCM)	(2651K - 2794K)	(2968K - 3136K)	(3369K - 3586K)	(3851K - 4130K)
Center Point (x,y)	(0.4578, 0.4101)	(0.4338, 0.403)	(0.4073, 0.3917)	(0.3818, 0.3797)

**Table 8: Cool White xy Bin Coordinates and Associated Typical CCT**

Bin Code	5000K
ANSI Bin (for reference only)	(4745K - 5311K)
74 (4 SDCM)	(4801K - 5282K)
Center Point (x,y)	(0.3447, 0.3553)

# Packaging and Labeling

Figure 14: Drawing for V8 Packaging Tube



Notes for Figure 14:

1. Each tube holds 40 V8 COB arrays.
2. One tube is sealed in an anti-static bag. Four bags are placed in a shipping box. Depending on quantities ordered, a bigger shipping box, containing four boxes may be used to ship products.
3. Each bag and box is to be labeled as shown above.
4. Dimensions for each tube are 8.3mm (W) x 14.3mm (H) x 530mm (L). Dimensions for the anti-static bag are 75 (W) x 615 (L) x 31 (T) mm. Dimensions for the shipping box are 58.7 x 133 x 7.9 cm

# Packaging and Labeling

**Figure 15: Gen. 7 Product Labeling**

Bridgelux COB arrays have laser markings on the back side of the substrate to help with product identification. In addition to the product identification markings, Bridgelux COB arrays also contain markings for internal Bridgelux manufacturing use only. The image below shows which markings are for customer use and which ones are for Bridgelux internal use only. The Bridgelux internal manufacturing markings are subject to change without notice, however these will not impact the form, function or performance of the COB array.



# Design Resources

## Application Notes

Bridgelux has developed a comprehensive set of application notes and design resources to assist customers in successfully designing with the V Series product family of LED array products. For all available application notes visit [www.bridgelux.com](http://www.bridgelux.com).

## Optical Source Models

Optical source models and ray set files are available for all Bridgelux products. Please contact your Bridgelux Sales Representative for more information.

## 3D CAD Models

Three dimensional CAD models depicting the product outline of all Bridgelux V Series LED arrays are available in both IGS and STEP formats. Please contact your Bridgelux sales representative for assistance.

## LM80

LM80 testing has been completed and the LM80 report is now available. Please contact your Bridgelux sales representatives for LM-80 report.

# Precautions

## CAUTION: CHEMICAL EXPOSURE HAZARD

Exposure to some chemicals commonly used in luminaire manufacturing and assembly can cause damage to the LED array. Please consult Bridgelux Application Note AN101 for additional information.

## CAUTION: RISK OF BURN

Do not touch the V Series LED array during operation. Allow the array to cool for a sufficient period of time before handling. The V Series LED array may reach elevated temperatures such that could burn skin when touched

## CAUTION

### CONTACT WITH LIGHT EMITTING SURFACE (LES)

Avoid any contact with the LES. Do not touch the LES of the LED array or apply stress to the LES (yellow phosphor resin area). Contact may cause damage to the LED array.

Optics and reflectors must not be mounted in contact with the LES (yellow phosphor resin area). Use the mechanical features of the LED array housing and/or edges to locate and secure optical devices as needed.

# Disclaimers

## MINOR PRODUCT CHANGE POLICY

The rigorous qualification testing on products offered by Bridgelux provides performance assurance. Slight cosmetic changes that do not affect form, fit, or function may occur as Bridgelux continues product optimization.

## STANDARD TEST CONDITIONS

Unless otherwise stated, array testing is performed at the nominal drive current.

# About Bridgelux: We Build Light That Transforms

At Bridgelux, we help companies, industries and people experience the power and possibility of light. Since 2002, we've designed LED solutions that are high performing, energy efficient, cost effective and easy to integrate. Our focus is on light's impact on human behavior, delivering products that create better environments, experiences and returns—both experiential and financial. And our patented technology drives new platforms for commercial and industrial luminaires.

**For more information about the company, please visit**  
**[bridgelux.com](http://bridgelux.com)**  
**[twitter.com/Bridgelux](https://twitter.com/Bridgelux)**  
**[facebook.com/Bridgelux](https://facebook.com/Bridgelux)**  
**[youtube.com/user/Bridgelux](https://youtube.com/user/Bridgelux)**  
**[linkedin.com/company/bridgelux-inc-\\_2](https://linkedin.com/company/bridgelux-inc-_2)**  
**WeChat ID: BridgeluxInChina**



46430 Fremont Boulevard  
Fremont, CA 94538 USA  
Tel (925) 583-8400  
**[www.bridgelux.com](http://www.bridgelux.com)**

© 2017 Bridgelux, Inc. All rights reserved 2017. Product specifications are subject to change without notice. Bridgelux and the Bridgelux stylized logo design are registered trademarks, and Decor Series is a trademark of Bridgelux, Inc. All other trademarks are the property of their respective owners.

**Bridgelux Gen 7 V8 Array Series Product Data Sheet DS104 Rev. D (12/2017)**