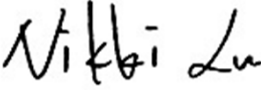
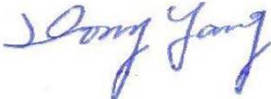

## PSE Technology Corporation

# SPECIFICATION FOR APPROVAL

CUSTOMER	
NOMINAL FREQUENCY	125.000000 MHz
PRODUCT TYPE	TYPE NX 5.0x3.2 SEAM SEALED CRYSTAL CLOCK OSCILLATOR
SPEC. NO. ( P/N )	NX5011B0125.000000
CUSTOMER P/N	
ISSUE DATE	May 18, 2016
VERSION	A

APPROVED	PREPARED	QA
		
<b>APPROVED BY CUSTOMER :</b>		<b>AVL Status</b>
<b>Please return one copy with approval to PSE-TW</b>		

### PSE Technology Corporation

No.2, Tzu-Chiang 5th Rd, Chung Li Industrial Park,  
 Chung Li City, Taoyuan County, Taiwan (R.O.C.)  
 TEL: 886-3-451-8888  
 FAX: 886-3-461-3865  
<http://www.saronix-ecera.com.tw>

- \*Pb-free
- \*RoHS Compliant
- \*HF-Halogen Free
- \*REACH Compliant

\*\*\* A company of  **PERICOM Semiconductor Corporation** \*\*\*

Pericom Internal Reference NO. NX51C50001



# TYPE NX 5.0x3.2 SEAM SEALED CRYSTAL CLOCK OSCILLATOR

**NX5011B0125.000000**

VER. A 18-May-16

## ELECTRICAL SPECIFICATIONS

Item	Symbol	Specifications	Units	Notes
Nominal Frequency	F <sub>0</sub>	125.000000	MHz	
Frequency Stability	FT	± 25	ppm	**See note
Operating Temperature Range	TR	-20 to +70	°C	
Supply Voltage	V <sub>DD</sub>	+3.3 ± 5.0%	V	+3.3V Typ., also support +2.5V
Logic Type	LT	LVC MOS		
Supply Current, Output Enabled	I <sub>DD</sub> /OE	60	mA	Max.
Supply Current, Output Disabled	I <sub>DD</sub> /OD	40	mA	Max.
Duty Cycle (Symmetry)	DC/SY	45 / 55	%	Measured 50% of Waveform
Rise / Fall Time	T <sub>R</sub> /T <sub>F</sub>	3	ns	Max. measured 20/80% of Waveform
Output Voltage "0" Level	V <sub>OL</sub>	0.4	V	Max.
Output Voltage "1" Level	V <sub>OH</sub>	V <sub>DD</sub> -0.4	V	Min.
Output Load	CL	15	pF	Max.
Jitter, Phase	RMS	0.4 / 0.6	ps	Typ./Max. 12KHz~20MHz Frequency Band
Jitter, Accumulated	RMS(1-σ)	6	ps	Max, 20,000 Consecutive Periods
Jitter, Peak to Peak	Pk-Pk	40	ps	Max, 100,000 Random Periods
Storage Temperature Range		-55 to +125	°C	

※ This product doesn't include harmful substance that stipulated by SONY SS-00259 Level 1 and S-AT2-001 Level 1 standard. RoHS Compliant (Pb - Free).

\*\*Stability includes all combinations of Operating Temperature, Load changes, rated Input (Supply) Voltage changes, Initial Calibration Tolerance (25°C), Aging (1 year at 25°C Average Effective Ambient Temperature), Shock and Vibration.

### Output Enable / Disable Function

Parameter	Min.	Typ.	Max.	Units	Notes
Input Voltage (Pin1), Output Enable	0.7V <sub>DD</sub>			V	Or Open
Input Voltage (Pin1), Output Disable (low power standby)			0.3V <sub>DD</sub>	V	Output is Hi-Z
Output Disable Delay			100	ns	
Output Enable Delay			100	ns	
Start Up Time			10	ms	

# TYPE NX 5.0x3.2 SEAM SEALED CRYSTAL CLOCK OSCILLATOR

***NX5011B0125.000000***

VER. A 18-May-16

## TEST CIRCUIT

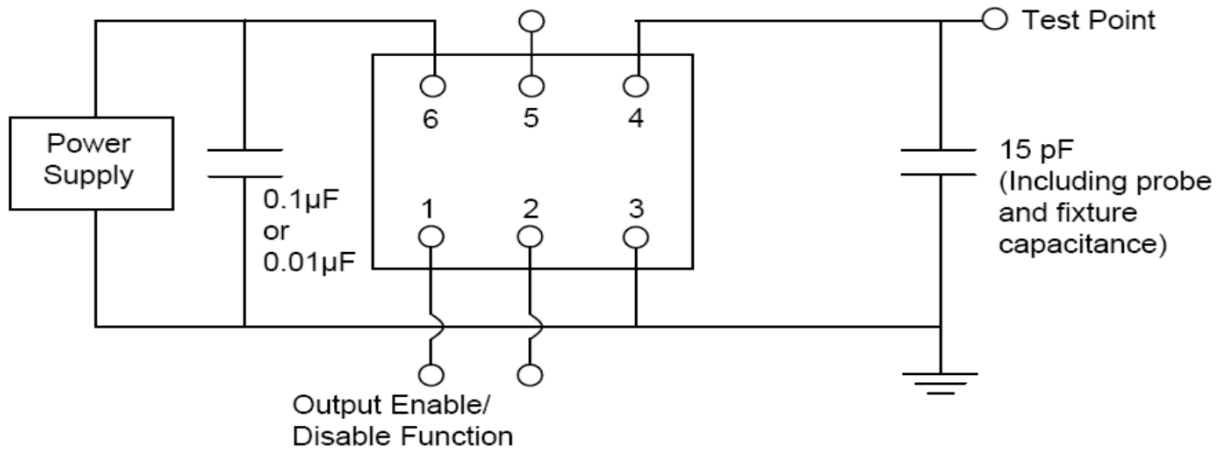

## OUTPUT WAVEFORM

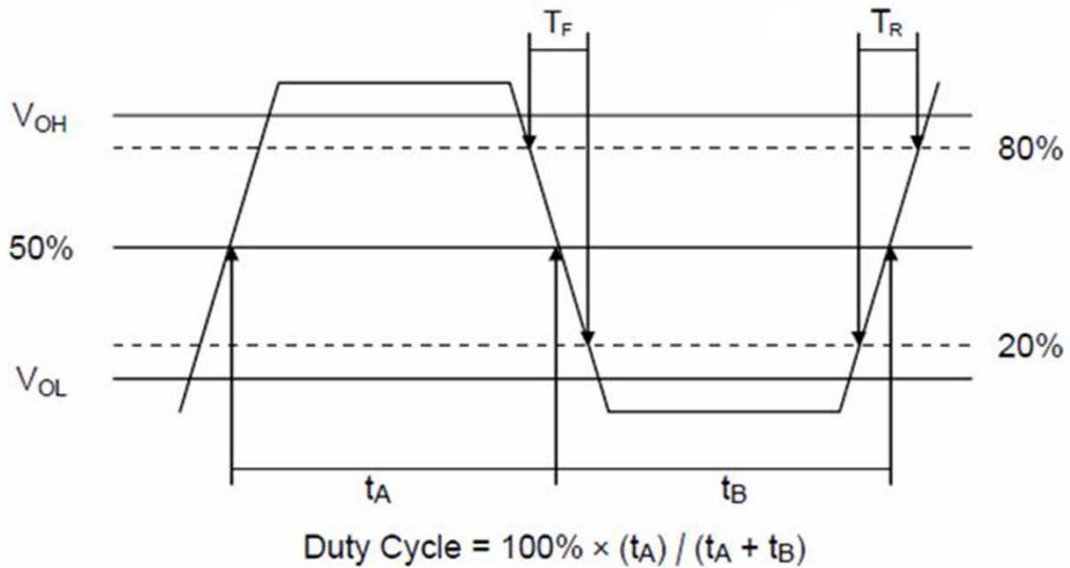

# TYPE NX 5.0x3.2 SEAM SEALED CRYSTAL CLOCK OSCILLATOR

**NX5011B0125.000000**

VER. A 18-May-16

## RELIABILITY SPECIFICATIONS

### ENVIRONMENTAL:

- a) THERMAL SHOCK: MIL-STD-883, Method 1011, Condition A
- b) MOISTURE RESISTANCE: MIL-STD-883, Method 1004
- c) VIBRATION: MIL-STD-883, Method 2007, Condition A
- d) RESISTANCE TO SOLDERING HEAT: J-STD-020D Table 5-2 Pb-free devices (except 2 cycles max)
- e) HAZARDOUS SUBSTANCE: Pb - free and RoHS Compliant.

### MECHANICAL:

- a) SHOCK: MIL-STD-883, Method 2002, Condition B
- b) SOLDERABILITY: JESD22-B102-D Method 2 (Preconditioning E)
- c) TERMINAL STRENGTH: MIL-STD-883, Method 2004, Test Condition D
- d) GROSS LEAK: MIL-STD-883, Method 1014, Condition C
- e) FINE LEAK: MIL-STD-883, Method 1014, Condition A2,  $R1=2 \times 10^{-8}$  atm cc/s
- f) SOLVENT RESISTANCE: MIL-STD-202, Method 215

## SUGGESTED IR REFLOW PROFILE

\*As per IPC-JEDEC J-STD-020D

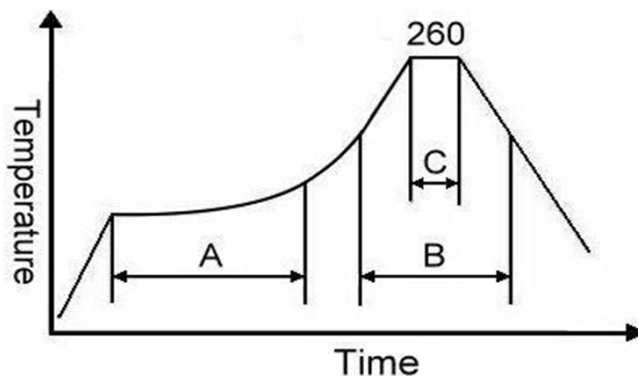

Note:

	Stage	Temperature	Time
A	Preheat	150~200°C	60~120 Sec
B	Primary Heat	217°C	60~150 Sec
C	Peak	260°C	10 Sec

For soldering reflow profile and reliability test ratings go to: <http://www.pericom.com/pdf/sre/reflow.pdf>

# TYPE NX 5.0x3.2 SEAM SEALED CRYSTAL CLOCK OSCILLATOR

**NX5011B0125.000000**

VER. A 18-May-16

## MARKING

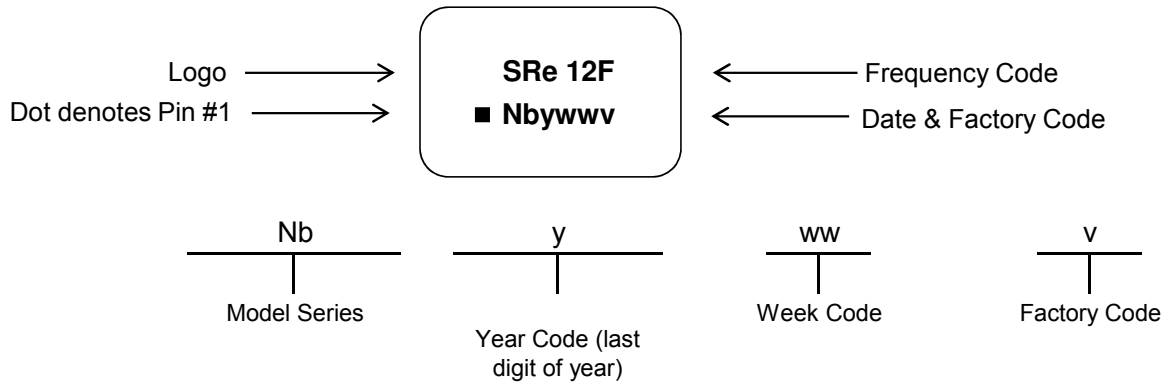

## MECHANICAL DRAWINGS ( Scale:None. Dimensions are in mm.)

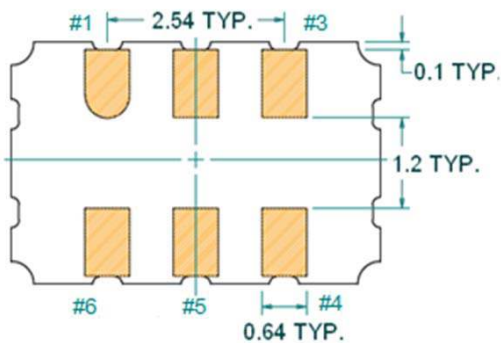
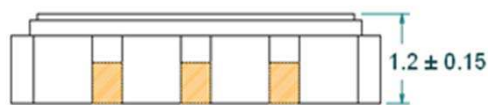
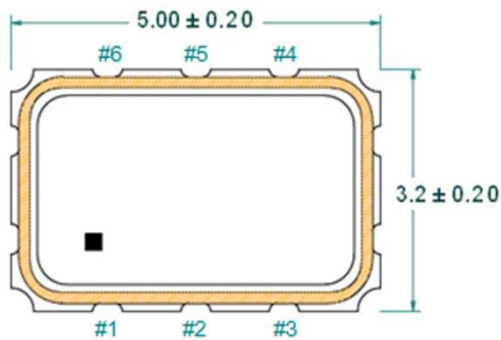

### Recommended Land Pattern\*

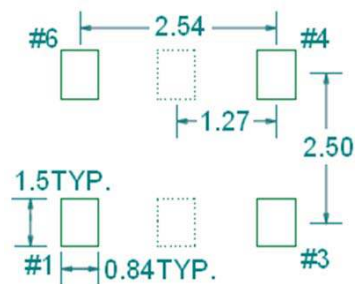

\*Note: pads 2 and 5 are optional (shown as dotted lines). XO's are designed to fit on industry standard, 4 pad layouts.

Pin	Function
1	OE Function
2	N/C
3	Ground
4	Output
5	N/C
6	V <sub>DD</sub>

\*Extended high frequency power decoupling is recommended (see test circuit for minimum recommendation). To ensure optimal performance, do not route RF traces beneath the package.

# TYPE NX 5.0x3.2 SEAM SEALED CRYSTAL CLOCK OSCILLATOR

**NX5011B0125.000000**

VER. A 18-May-16

## TAPE&REEL

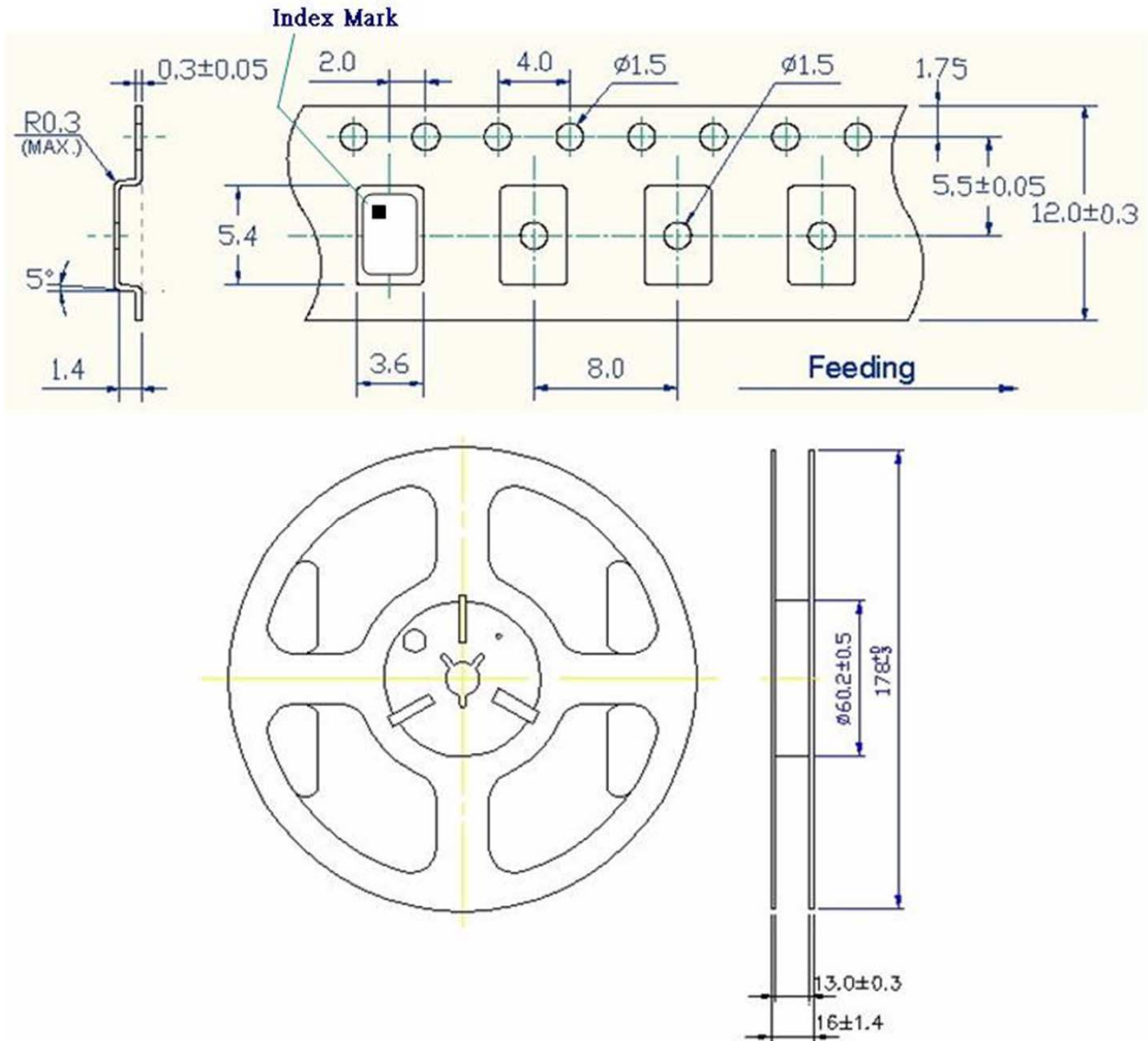

1. 230mm minimum leader which consist of carrier and/or tape followed by a minimum of 160mm of empty carrier tape sealed with cover tape.
2. 160mm minimum trailer of empty carrier tape sealed with cover tape.

# TYPE NX 5.0x3.2 SEAM SEALED CRYSTAL CLOCK OSCILLATOR

**NX5011B0125.000000**

VER. A 18-May-16

## PACKING

