

# AN7510

## Dual 1-W BTL audio power amplifier

### ■ Overview

The AN7510 is an audio power amplifier IC for stereo system. The BTL (Balanced Transformer-Less) method can provide fewer external parts and more easy design for applications.

### ■ Features

- 1-W output (8 Ω) with supply voltage of 5 V
- On-chip standby function
- On-chip volume function

### ■ Applications

- Televisions, audio equipment, personal computers, and active speakers

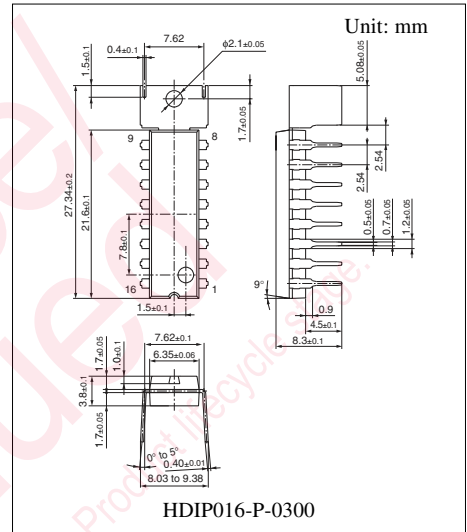

Note) The package of this product will be changed to lead-free type (HDIP016-P-0300A). See the new package dimensions section later of this datasheet.

### ■ Block Diagram

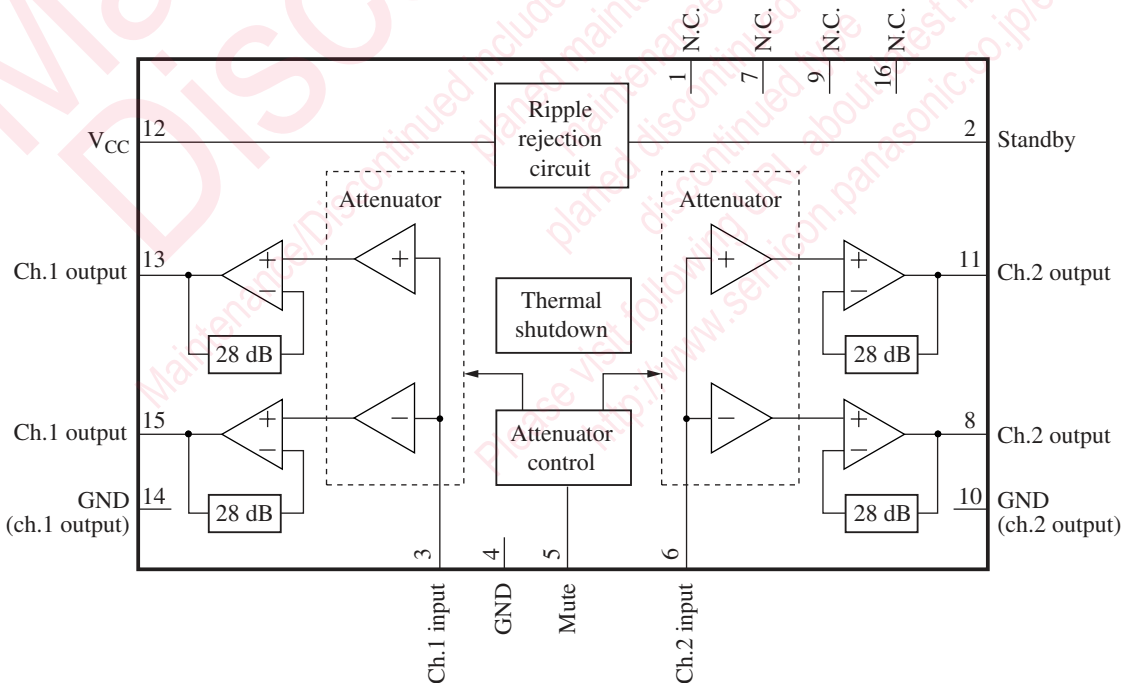

### ■ Pin Descriptions

Pin No.	Description	Pin No.	Description
1	N.C.	9	N.C.
2	Standby (standby state if this pin is open.)	10	Ground (output ch.2)
3	Ch.1 input	11	Ch.2 + output
4	Ground (input)	12	Power voltage
5	Muting (muting off if this pin is open.)	13	Ch.1 + output
6	Ch.2 input	14	Ground (output ch.1)
7	N.C.	15	Ch.1 – output
8	Ch.2 – output	16	N.C.

Note) Please do not apply voltage or current to the N.C. pin from outside.

### ■ Absolute Maximum Ratings

Parameter	Symbol	Rating	Unit
Supply voltage <sup>*2</sup>	$V_{CC}$	14	V
Supply current	$I_{CC}$	2.0	A
Power dissipation <sup>*3</sup>	$P_D$	1 127	mW
Operating ambient temperature <sup>*1</sup>	$T_{opr}$	-25 to +70	°C
Storage temperature <sup>*1</sup>	$T_{stg}$	-55 to +150	°C

Note) \*1: Except for the operating ambient temperature and storage temperature, all ratings are for  $T_a = 25^\circ\text{C}$ .

\*2: At no signal.

\*3: The power dissipation shown is the value for  $T_a = 70^\circ\text{C}$ .

### ■ Recommended Operating Range

Parameter	Symbol	Range	Unit
Supply voltage	$V_{CC}$	3.5 to 13.5	V

■ Electrical Characteristics at  $V_{CC} = 5.0\text{ V}$ ,  $R_L = 8\ \Omega$ ,  $f = 1\text{ kHz}$ ,  $T_a = 25^\circ\text{C} \pm 2^\circ\text{C}$

Parameter	Symbol	Conditions	Min	Typ	Max	Unit
Quiescent circuit current	$I_{CQ}$	$V_{IN} = 0\text{ mV}$	—	50	100	mA
Standby current	$I_{STB}$	$V_{IN} = 0\text{ mV}$	—	1	10	$\mu\text{A}$
Output noise voltage *	$V_{NO}$	$R_g = 10\text{ k}\Omega$	—	0.14	0.4	mV[rms]
Voltage gain	$G_V$	$P_O = 0.25\text{ W}$	32	34	36	dB
Total harmonic distortion	THD	$P_O = 0.25\text{ W}$	—	0.05	0.5	%
Maximum output power	$P_{O1}$	THD = 10%	0.8	1.1	—	W
Ripple rejection ratio *	RR	$R_g = 10\text{ k}\Omega$ , $V_R = 0.5\text{ V[rms]}$ , $f_R = 120\text{ Hz}$	30	50	—	dB
Output offset voltage	$V_{OFF}$	$R_g = 10\text{ k}\Omega$	-300	0	300	mV
Muting effect *	MT	$P_O = 0.25\text{ W}$	70	86	—	dB
Channel balance	CB	$P_O = 0.25\text{ W}$	-1	0	1	dB
Channel crosstalk	CT	$P_O = 0.25\text{ W}$	55	65	—	dB

Note) \*: In measuring, the filter for the range of 15 Hz to 30 kHz (12 dB/OCT) is used.

■ Terminal Equivalent Circuits

Pin No.	Pin name	Equivalent circuit	Voltage
1	N.C.	Open	—
2	Standby pin		5 V
3	Ch.1 input pin		—

■ Terminal Equivalent Circuits (continued)

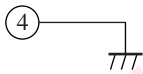
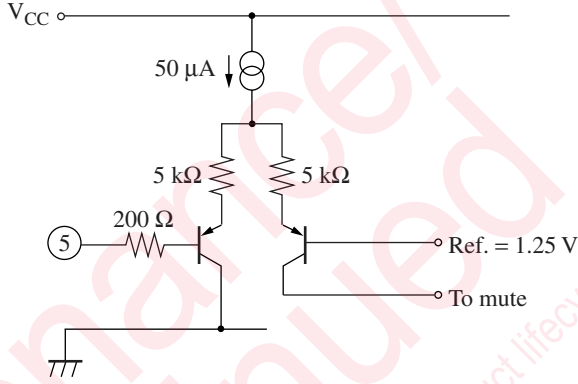
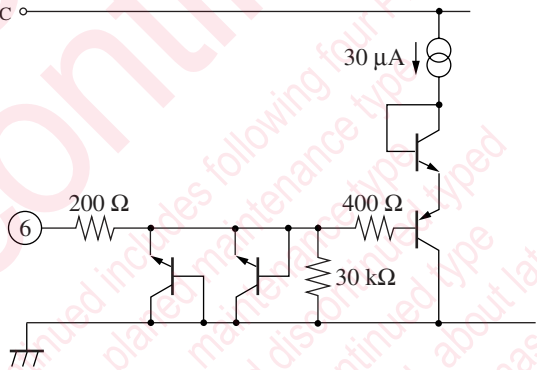
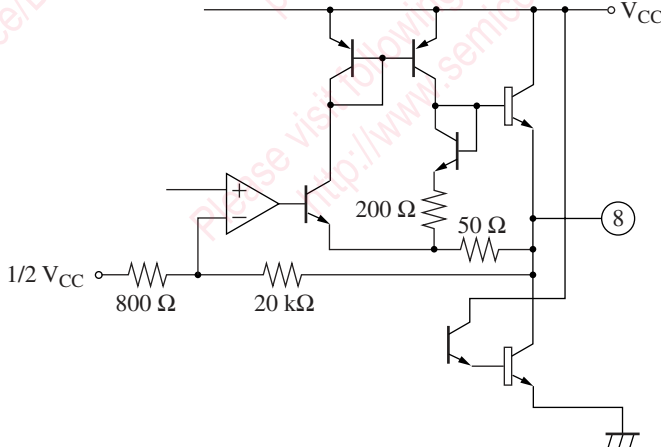
Pin No.	Pin name	Equivalent circuit	Voltage
4	GND		0 V
5	Muting pin		—
6	Ch.1 input pin		—
7	N.C.	Open	—
8	Ch.2 – output pin		2.15 V
9	N.C.	Open	—

■ Terminal Equivalent Circuits (continued)

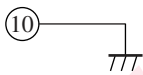
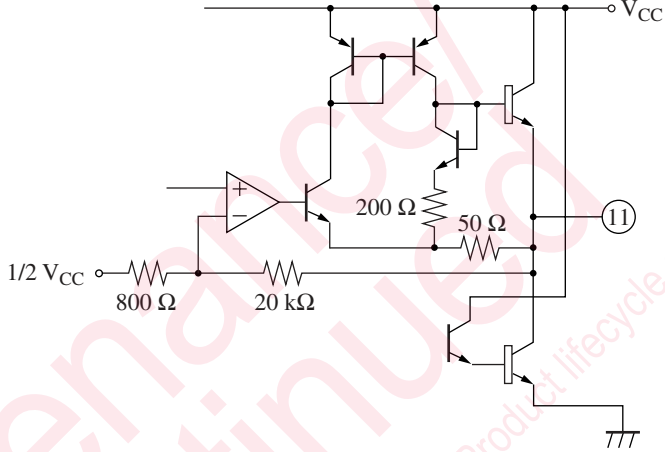
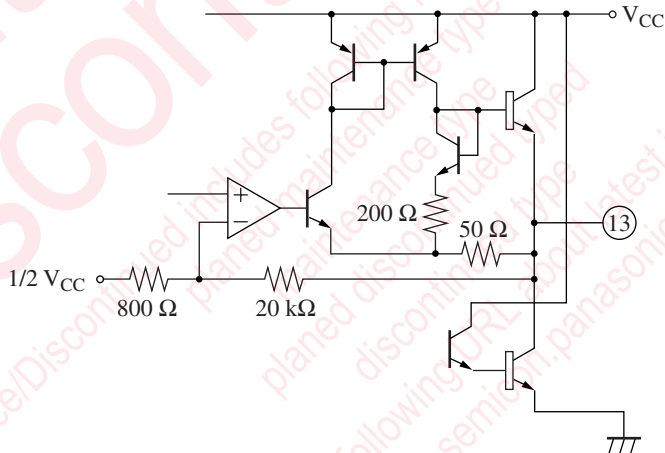
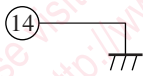
Pin No.	Pin name	Equivalent circuit	Voltage
10	GND		0 V
11	Ch.2 + output pin		2.15 V
12	V <sub>CC</sub>	—	5.0 V
13	Ch.1 + output pin		2.15 V
14	GND		0 V

■ Terminal Equivalent Circuits (continued)

Pin No.	Pin name	Equivalent circuit	Voltage
15	Ch.1 – output pin		2.15 V
16	N.C.	Open	—

■ Usage Notes

- Please avoid the short circuit to  $V_{CC}$ , ground, or load short circuit.
- Please connect the cooling fin with the GND potential.
- The thermal shutdown circuit operates at about  $T_j = 150^\circ\text{C}$ . However, the thermal shutdown circuit is reset automatically if the temperature drops.
- Please carefully design the heat radiation especially when you take out high power at high  $V_{CC}$ .
- Please connect only the ground of signal with the signal GND of the amplifier in the previous stage.

■ Technical Data

- $P_D - T_a$  curve of HDIP016-P-0300

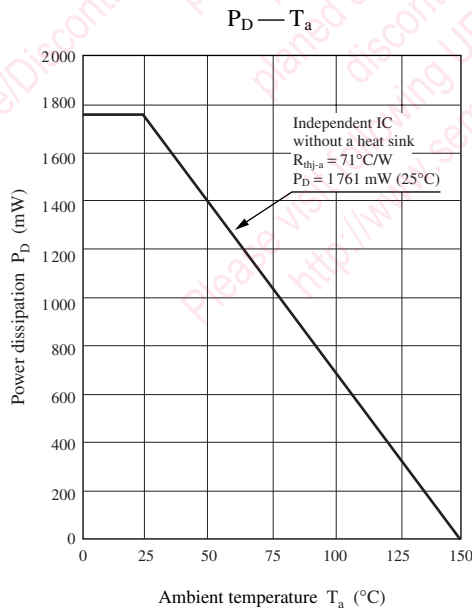

■ Technical Data (continued)

• Main characteristics

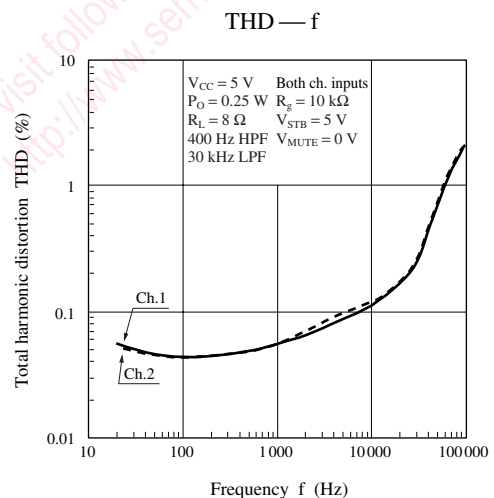
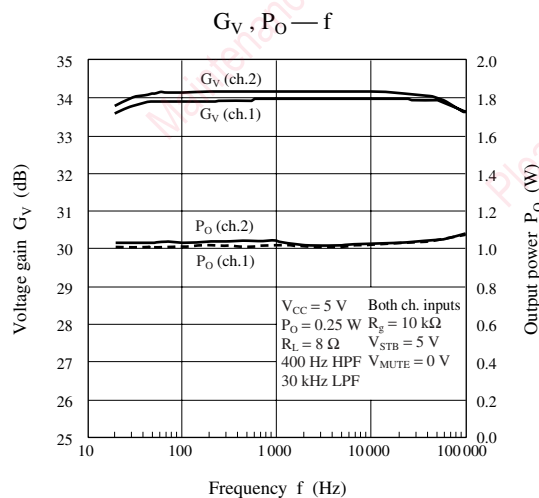
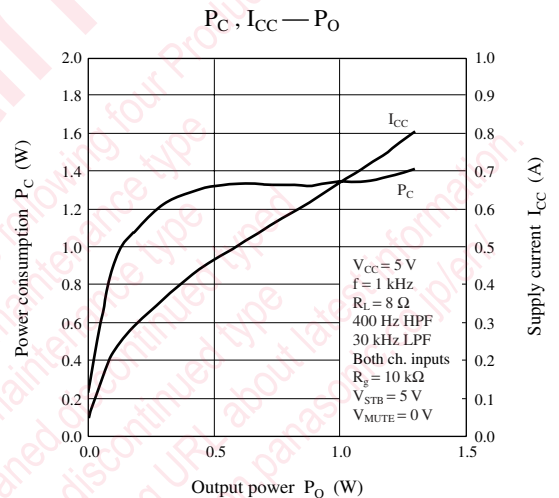
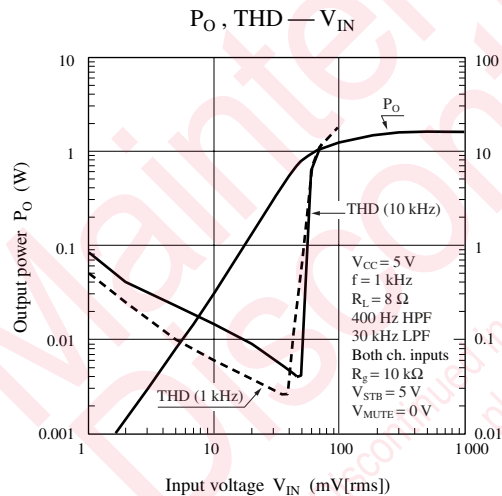
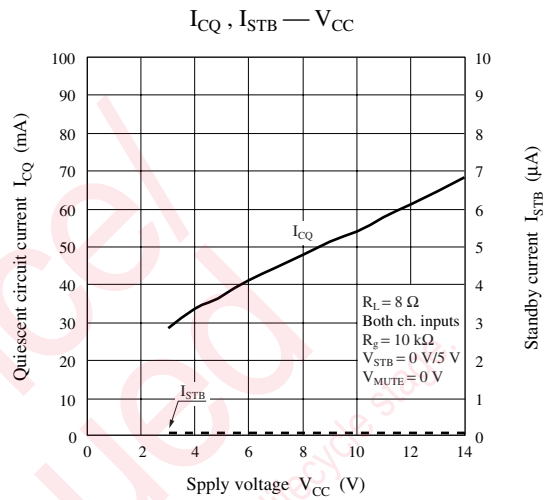
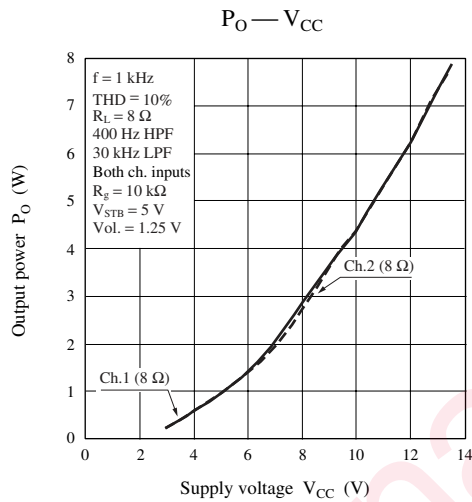

■ Technical Data (continued)

• Main characteristics (continued)

$G_V$ , THD —  $V_{CC}$

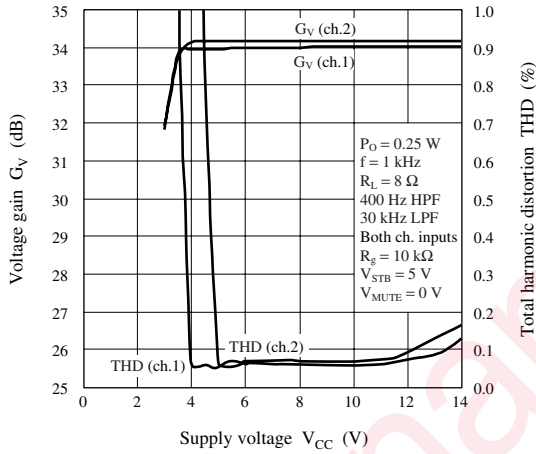

RR —  $V_{CC}$

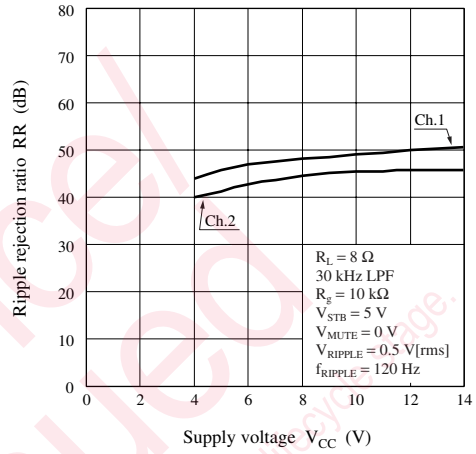

RR —  $V_{RIPPLE}$

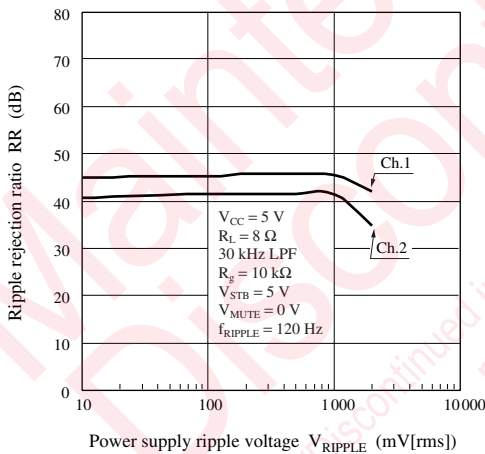

RR —  $f_{RIPPLE}$

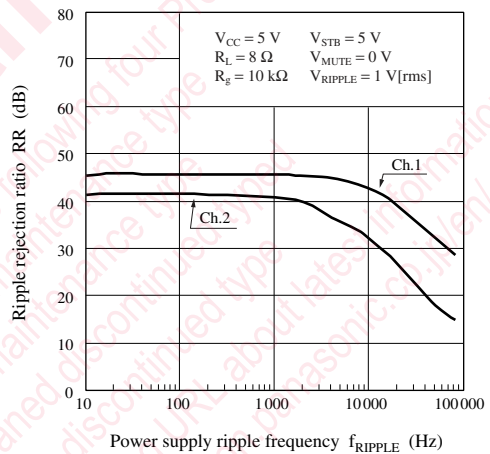

CT —  $V_{CC}$

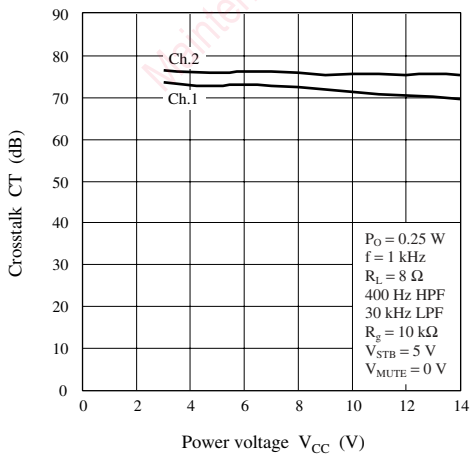

CT —  $V_{IN}$

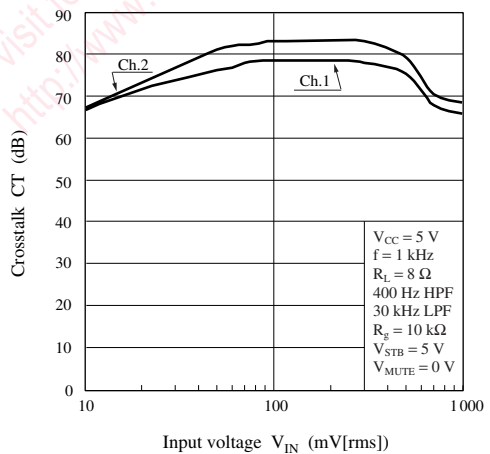



■ Technical Data (continued)

• Main characteristics (continued)

CT — f

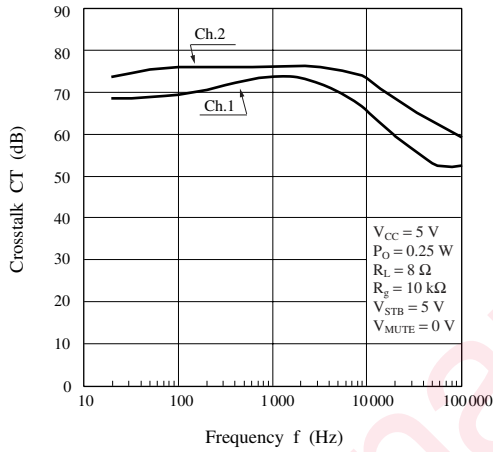

$V_{NO} — V_{CC}$

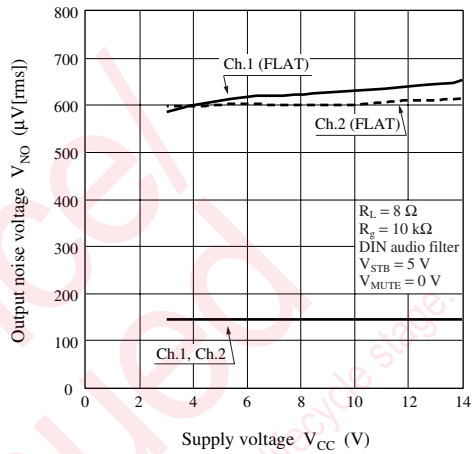

$V_{NO} — R_g$

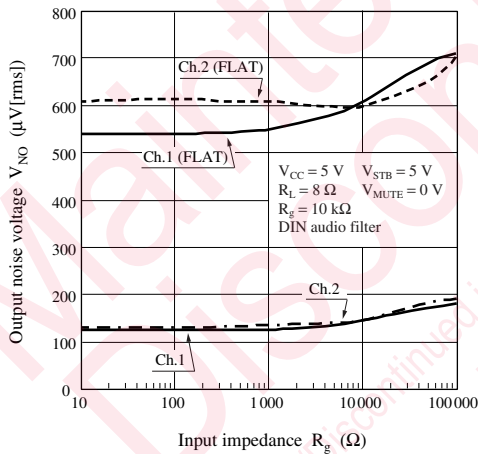

MT —  $V_{IN}$

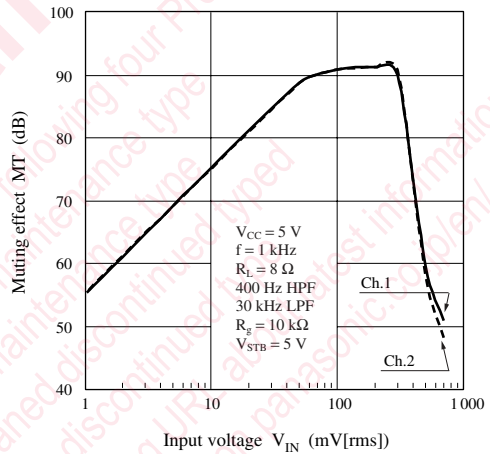

MT — f

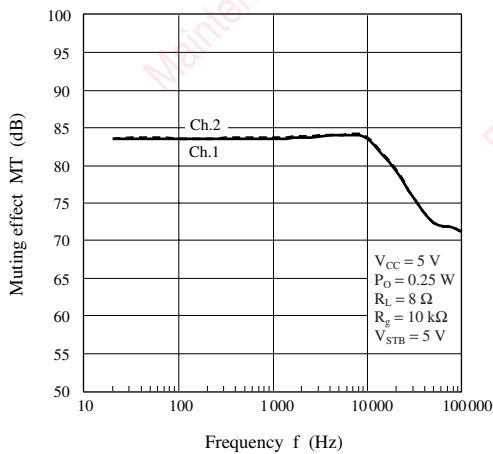

$I_{CQ} — V_{STB}$

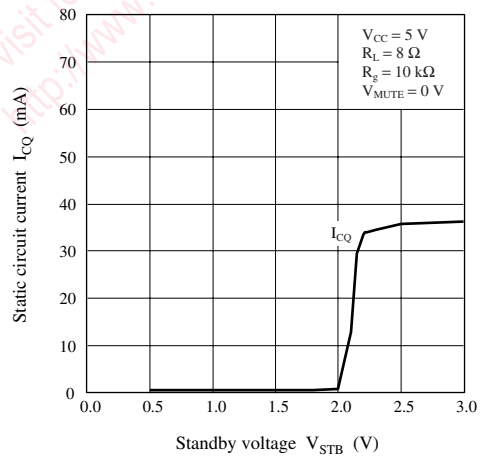

■ Technical Data (continued)

• Example of PCB pattern

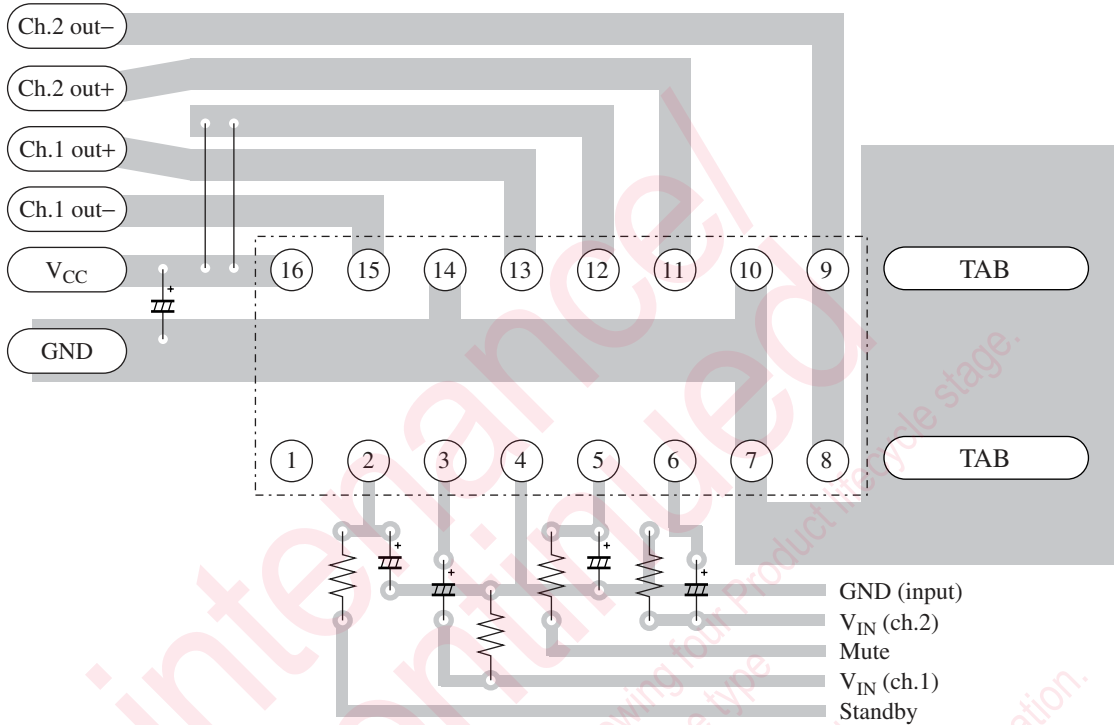

■ Application Circuit Example

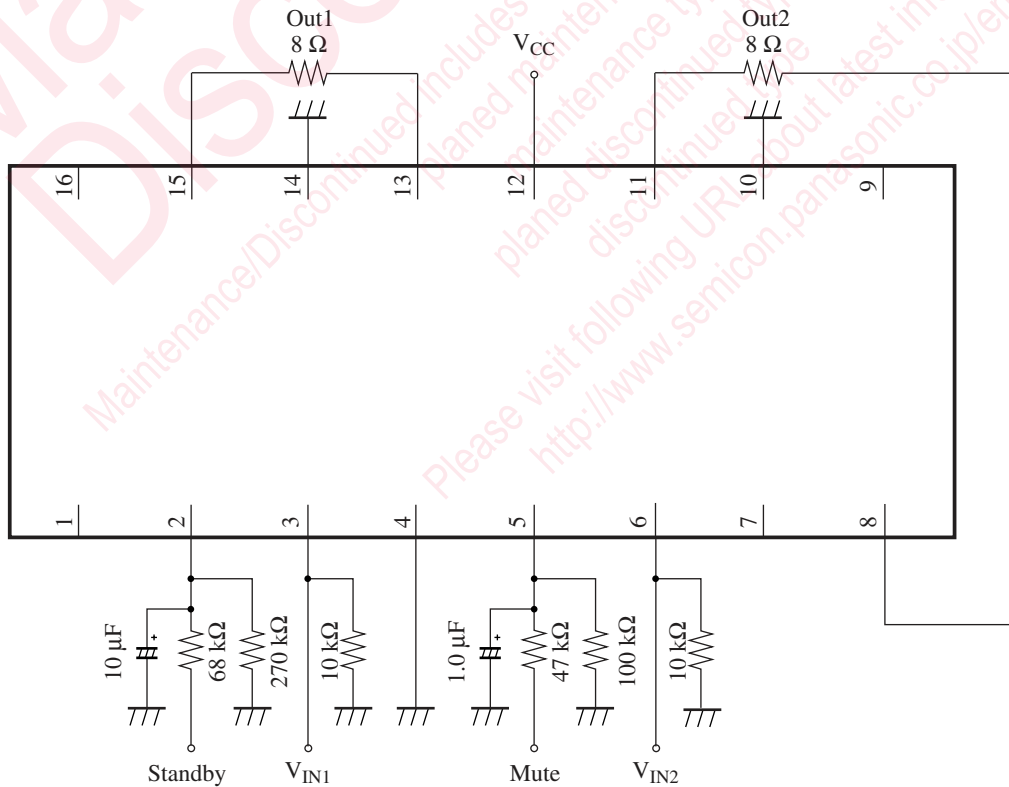

■ New Package Dimensions (Unit: mm)

- HDIP016-P-0300A (Lead-free package)

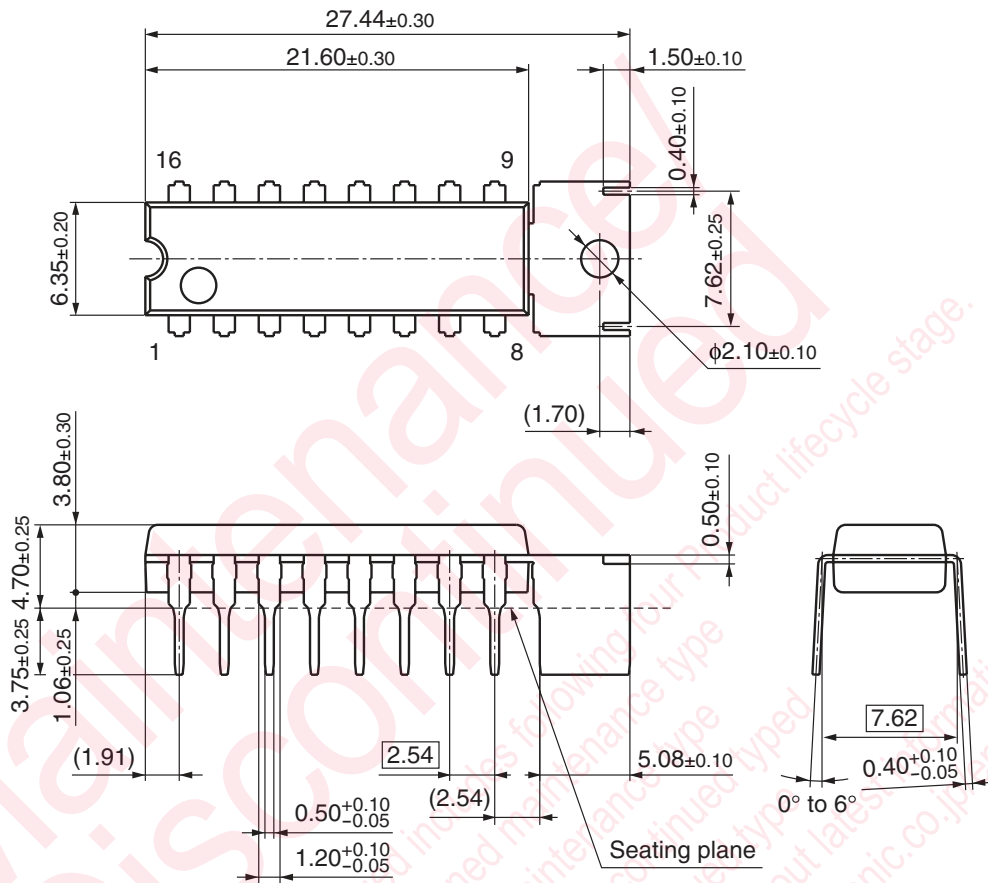

## Request for your special attention and precautions in using the technical information and semiconductors described in this book

- (1) If any of the products or technical information described in this book is to be exported or provided to non-residents, the laws and regulations of the exporting country, especially, those with regard to security export control, must be observed.
- (2) The technical information described in this book is intended only to show the main characteristics and application circuit examples of the products, and no license is granted under any intellectual property right or other right owned by our company or any other company. Therefore, no responsibility is assumed by our company as to the infringement upon any such right owned by any other company which may arise as a result of the use of technical information described in this book.
- (3) The products described in this book are intended to be used for standard applications or general electronic equipment (such as office equipment, communications equipment, measuring instruments and household appliances).  
Consult our sales staff in advance for information on the following applications:
  - Special applications (such as for airplanes, aerospace, automobiles, traffic control equipment, combustion equipment, life support systems and safety devices) in which exceptional quality and reliability are required, or if the failure or malfunction of the products may directly jeopardize life or harm the human body.
  - Any applications other than the standard applications intended.
- (4) The products and product specifications described in this book are subject to change without notice for modification and/or improvement. At the final stage of your design, purchasing, or use of the products, therefore, ask for the most up-to-date Product Standards in advance to make sure that the latest specifications satisfy your requirements.
- (5) When designing your equipment, comply with the range of absolute maximum rating and the guaranteed operating conditions (operating power supply voltage and operating environment etc.). Especially, please be careful not to exceed the range of absolute maximum rating on the transient state, such as power-on, power-off and mode-switching. Otherwise, we will not be liable for any defect which may arise later in your equipment.  
Even when the products are used within the guaranteed values, take into the consideration of incidence of break down and failure mode, possible to occur to semiconductor products. Measures on the systems such as redundant design, arresting the spread of fire or preventing glitch are recommended in order to prevent physical injury, fire, social damages, for example, by using the products.
- (6) Comply with the instructions for use in order to prevent breakdown and characteristics change due to external factors (ESD, EOS, thermal stress and mechanical stress) at the time of handling, mounting or at customer's process. When using products for which damp-proof packing is required, satisfy the conditions, such as shelf life and the elapsed time since first opening the packages.
- (7) This book may be not reprinted or reproduced whether wholly or partially, without the prior written permission of Matsushita Electric Industrial Co., Ltd.