



American Opto Plus LED Corp.

L314GT

3mm Green Lamp LED

DESCRIPTION

- Round type
- T1 (3mm) diameter
- Lens color: Green Transparent
- With flange
- Solder leads without stand-off

FEATURES

- Emitted color: Green
- Technology: GaP
- Viewing angle: 30°
- Peak wavelength $\lambda_p = 565\text{nm}$

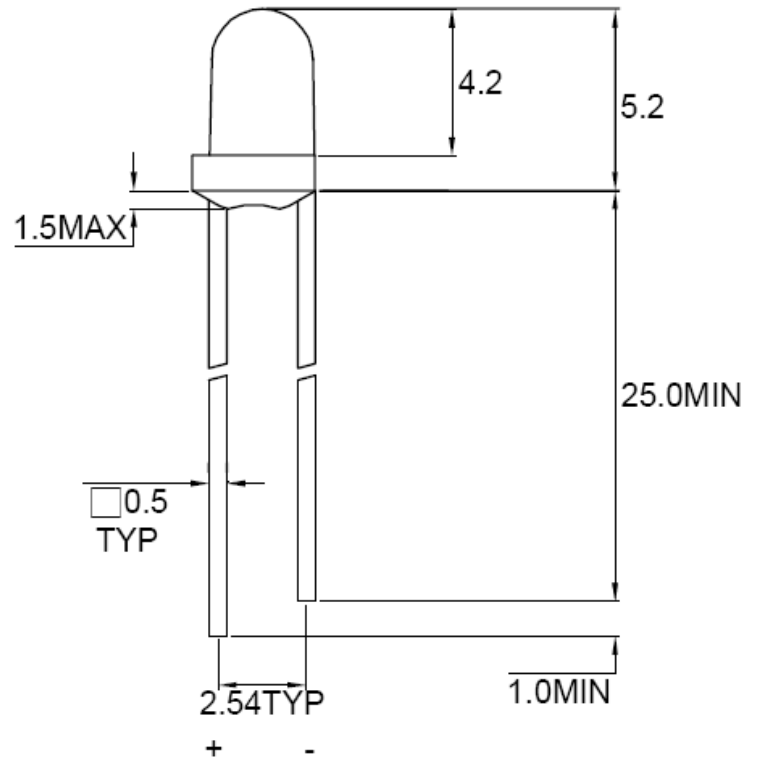
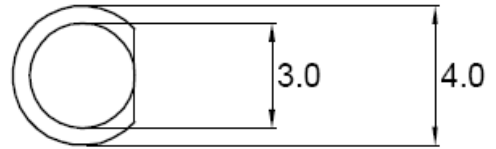

NOTES:

1. All dimensions are in millimeters tolerance is $\pm 0.25\text{mm}$ unless otherwise noted;

Directivity Radiation

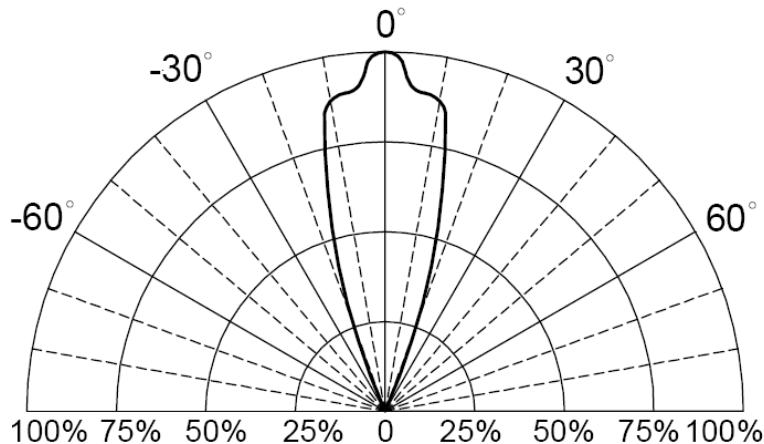



American Opto Plus LED Corp.

L314GT

3mm Green Lamp LED

ABSOLUTE MAXIMUM RATINGS

(Ta=25°C)

Parameter	Symbol	Ratings	Unit
Forward Current	I _f	15	mA
Peak Forward Current Duty (1/10@10KHz)	I _{fp}	80	mA
Power Dissipation	P _D	50	mW
Reverse Current @ 5V	I _r	10	μA
Operating temperature range	T _{opr}	-40~+85	°C
Storage temperature range	T _{stg}	-40~+100	°C

OPTICAL-ELECTRICAL CHARACTERISTICS

(Ta=25°C)

Parameter	Symbol	Test Condition	Min	Typ	Max	Unit
Luminous Intensity	I _v	I _F =20mA	20	35	--	mcd
Peak Wavelength	λ _D		--	--	565	nm
Spectral Line Half-Width	Δλ		--	30	--	nm
Forward Voltage	V _f		1.7	2.1	--	V
Viewing angle	2θ ½		--	30	--	Deg

- *Note: 1. The forward voltage data did not include ±0.1V testing tolerance.
2. The luminous intensity data did not include ±15% testing tolerance.



American Opto Plus LED Corp.

L314GT

3mm Green Lamp LED

TYPICAL ELECTRO-OPTICAL CHARACTERISTIC CURVES

Fig.1 Forward current vs. Forward Voltage

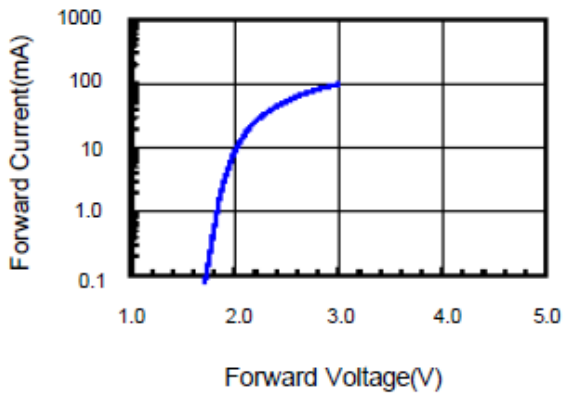

Fig.2 Relative Intensity vs. Forward Current

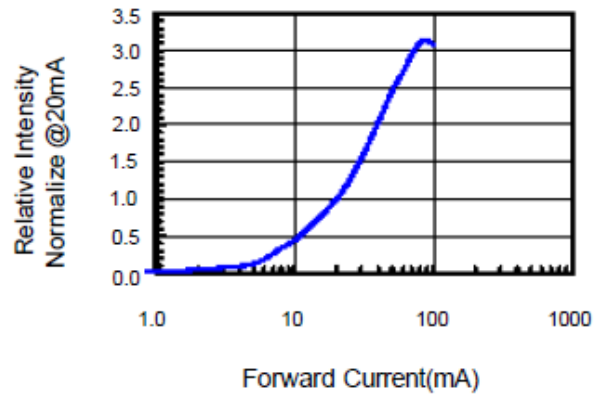

Fig.3 Forward Voltage vs. Temperature

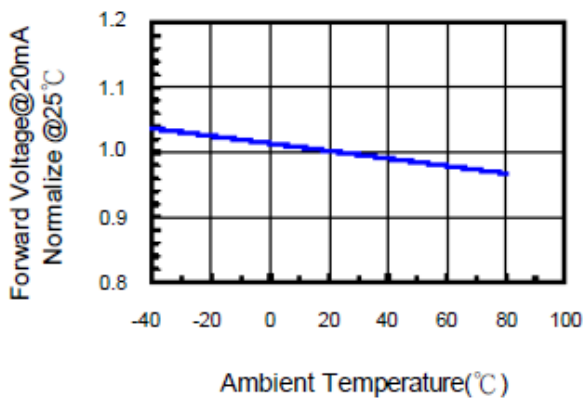

Fig.4 Relative Intensity vs. Temperature

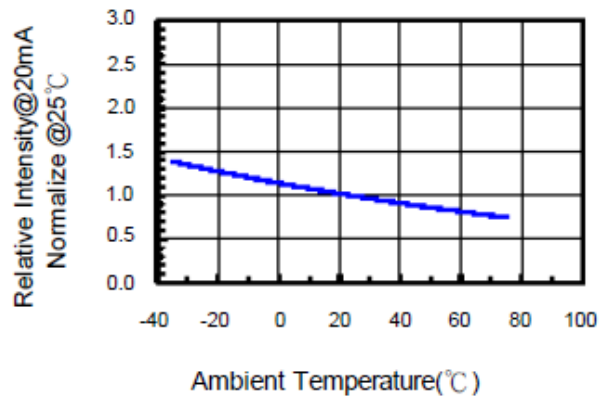

Fig.5 Relative Intensity vs. Wavelength

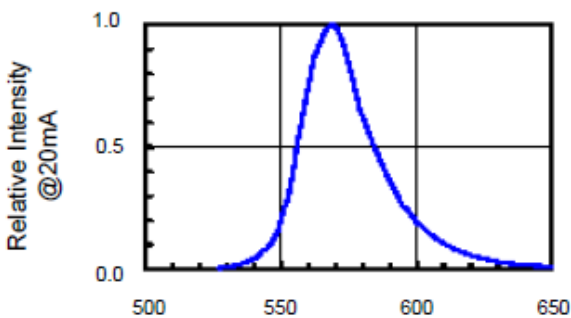

Fig.6 Directive Radiation



American Opto Plus LED Corp.

L314GT

3mm Green Lamp LED

SOLDERING CONDITION (Pb-Free)

1. Iron:

Soldering Iron: 30W Max

Temperature 350°C Max

Soldering Time: 3 Seconds Max (One Time)

Distance: 2mm Min (From solder joint to body)

2. Wave Soldering Profile

Dip Soldering

Preheat: 120°C Max

Preheat time: 60 seconds Max

Ramp-up

2°C/sec (Max)

Ramp-Down: -5°C/sec (Max)

Solder Bath: 260°C Max

Dipping Time: 3 seconds Max

Distance: 2mm Min (from solder joint to body)

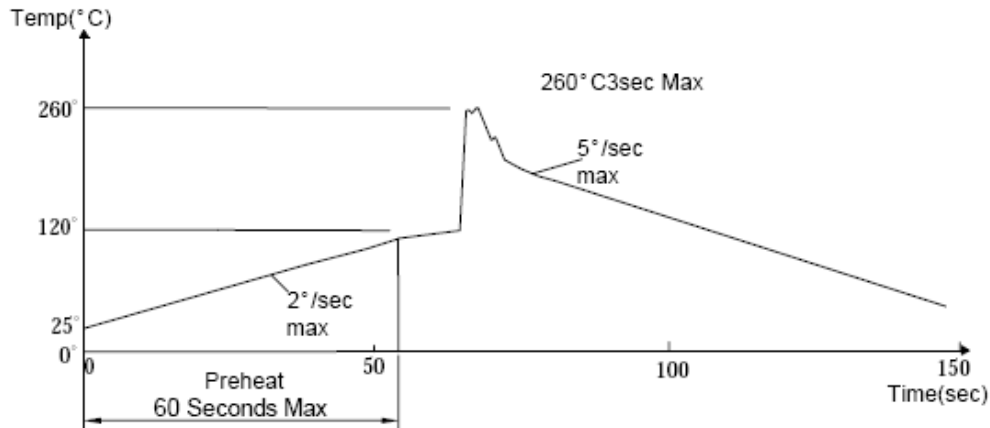



American Opto Plus LED Corp.

L314GT

3mm Green Lamp LED

RELIABILITY TEST:

Test Item	Test Condition	Description	Reference Standard
Operating Life Test	1.Under Room Temperature 2.If=20mA 3.t=1000 hrs (-24hrs, +72hrs)	This test is conducted for the purpose of determining the resistance of a part in electrical and thermal stressed.	MIL-STD-750: 1026 MIL-STD-883: 1005 JIS C 7021: B-1
High Temperature Storage Test	1.Ta=105 °C±5°C 2.t=1000 hrs (-24hrs, +72hrs)	The purpose of this is the resistance of the device which is laid under condition of high temperature for hours.	MIL-STD-883:1008 JIS C 7021: B-10
Low Temperature Storage Test	1.Ta=-40 °C±5°C 2.t=1000 hrs (-24hrs, +72hrs)	The purpose of this is the resistance of the device which is laid under condition of low temperature for hours.	JIS C 7021: B-12
High Temperature High Humidity Test	1.Ta=65 °C±5°C 2.RH=90%~95% 3.t=240hrs ±2hrs	The purpose of this test is the resistance of the device under tropical for hours.	MIL-STD-202:103B JIS C 7021: B-11
Thermal Shock Test	1.Ta=105 °C±5°C & -40 °C±5°C (10min) (10min) 2.total 10 cycles	The purpose of this is the resistance of the device to sudden extreme changes in high and low temperature.	MIL-STD-202: 107D MIL-STD-750: 1051 MIL-STD-883: 1011
Solder Resistance Test	1.T.Sol=260 °C±5°C 2.Dwell time= 10 ±1sec.	This test intended to determine the thermal characteristic resistance of the device to sudden exposures at extreme changes in temperature when soldering the lead wire.	MIL-STD-202: 210A MIL-STD-750: 2031 JIS C 7021: A-1
Solderability Test	1.T.Sol=230 °C±5°C 2.Dwell time=5 ±1sec	This test intended to see soldering well performed or not.	MIL-STD-202: 208D MIL-STD-750: 2026 MIL-STD-883: 2003 JIS C 7021: A-2