

HEIDI-O-90

~13° x 45° oval beam optimized for Cree XP-G and XP-E. Variant with beam direction rotated 90°.

SPECIFICATION:

Dimensions	Ø 21.6 mm
Height	12.1 mm
Fastening	tape, pin
ROHS compliant	yes ⓘ



MATERIALS:

Component	Type	Material	Colour	Finish
HEIDI-O-90	Single lens	PMMA	clear	
HEIDI-TAPE	Tape	Acrylic foam	black	

ORDERING INFORMATION:

Component	Type	Qty in box	MOQ	MPQ	Box weight (kg)
CA11267_HEIDI-O-90	Single lens	3264	204	204	10.4
» Box size: 480 x 280 x 300 mm					

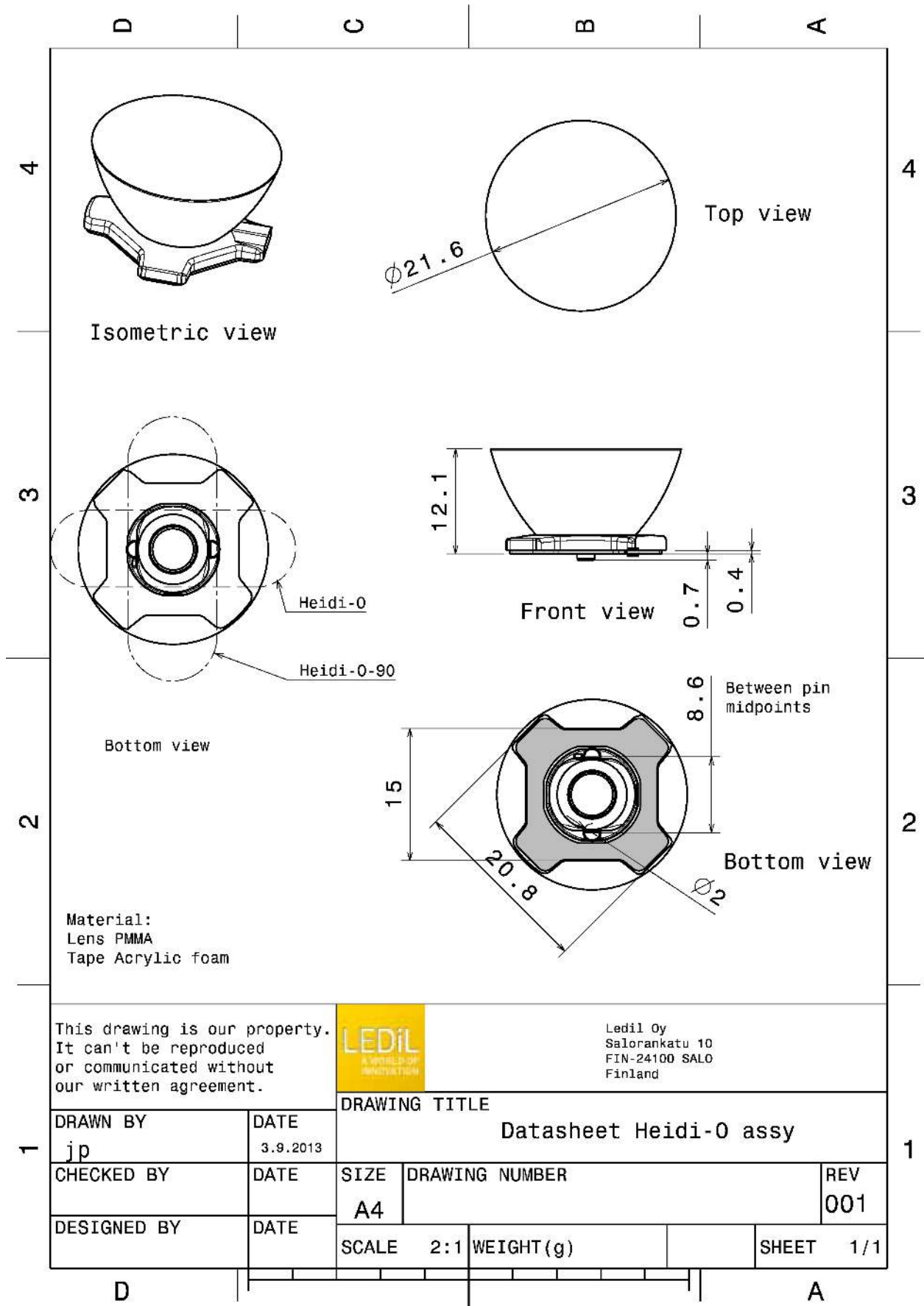

See also our general installation guide: www.ledil.com/installation_guide

OPTICAL RESULTS (MEASURED):

CREE ⇄ LED

LED XB-D
 FWHM / FWTM 12.0 + 49.0° / 34.0 + 78.0°
 Efficiency 87 %
 Peak intensity 3.5 cd/lm
 LEDs/each optic 1
 Light colour White
 Required components:

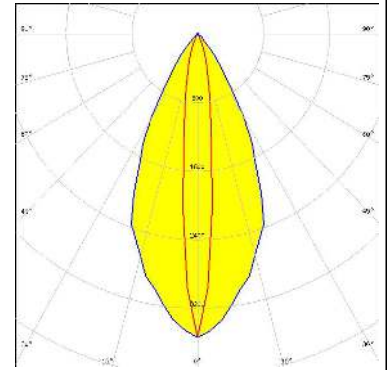

CREE ⇄ LED

LED XB-H
 FWHM / FWTM 11.0 + 52.0° / 34.0 + 80.0°
 Efficiency 80 %
 Peak intensity 3.2 cd/lm
 LEDs/each optic 1
 Light colour White
 Required components:

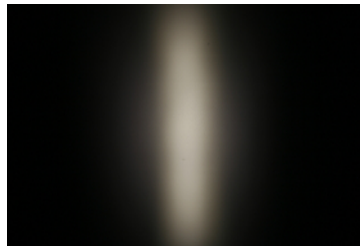

CREE ⇄ LED

LED XD16
 FWHM / FWTM 11.0 + 52.0° / 30.0 + 76.0°
 Efficiency 88 %
 Peak intensity 3.1 cd/lm
 LEDs/each optic 1
 Light colour White
 Required components:

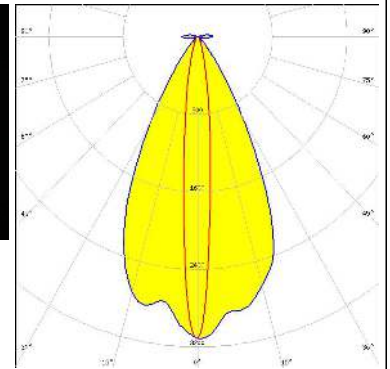
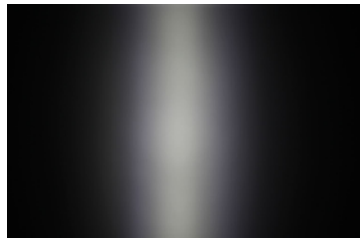

CREE ⇄ LED

LED XP-E
 FWHM / FWTM 9.0 + 50.0° / 25.0 + 72.0°
 Efficiency 87 %
 Peak intensity 4.2 cd/lm
 LEDs/each optic 1
 Light colour White
 Required components:

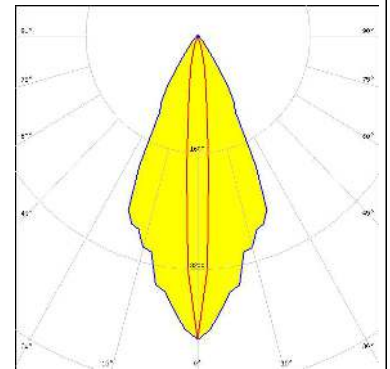

OPTICAL RESULTS (MEASURED):

CREE LED

LED XP-E2
 FWHM / FWTM 9.0 + 55.0° / 23.0 + 76.0°
 Efficiency 84 %
 Peak intensity 4.6 cd/lm
 LEDs/each optic 1
 Light colour White
 Required components:

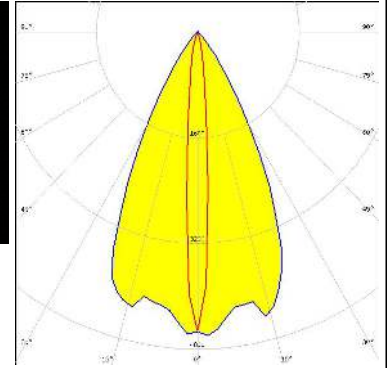
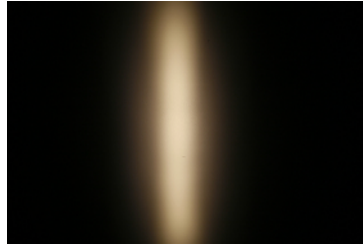

CREE LED

LED XP-G
 FWHM / FWTM 14.0 + 44.0° / 32.0 + 70.0°
 Efficiency 87 %
 Peak intensity 3.4 cd/lm
 LEDs/each optic 1
 Light colour White
 Required components:

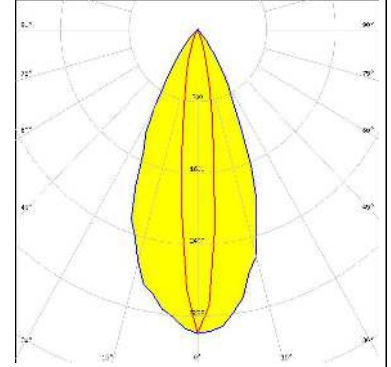

CREE LED

LED XQ-E HD
 FWHM / FWTM 7.0 + 56.0° / 23.0 + 77.0°
 Efficiency 94 %
 Peak intensity 4.7 cd/lm
 LEDs/each optic 1
 Light colour White
 Required components:

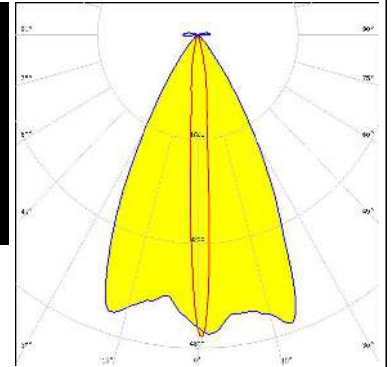



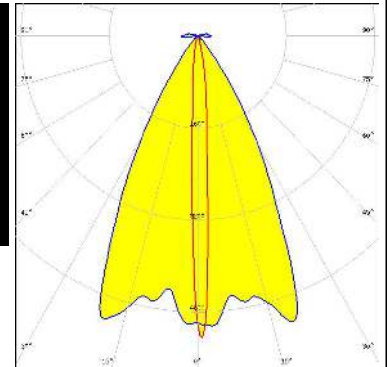

CREE LED



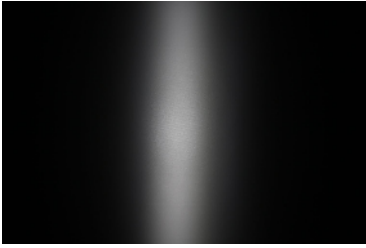
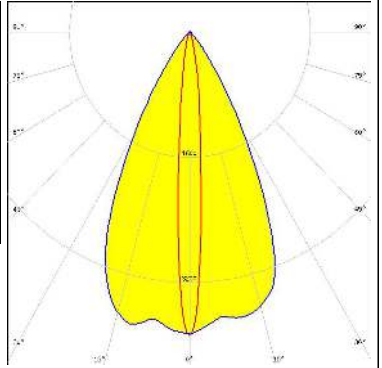
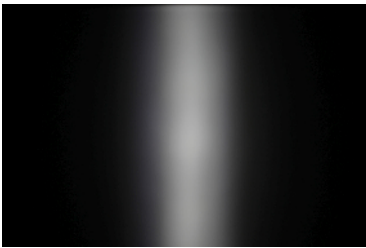
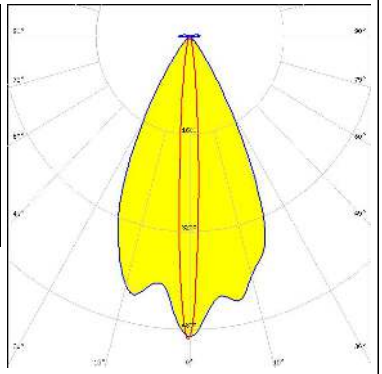

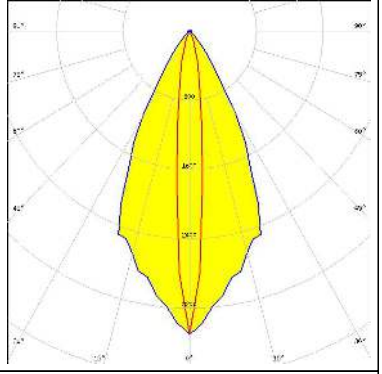

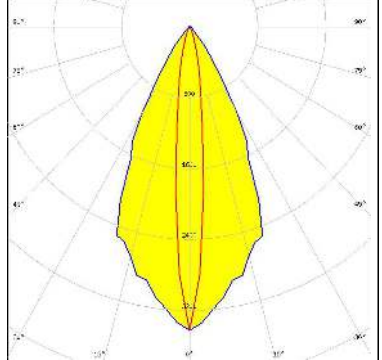
LED XQ-E HI
 FWHM / FWTM 6.0 + 57.0° / 20.0 + 76.0°
 Efficiency 94 %
 Peak intensity 5.3 cd/lm
 LEDs/each optic 1
 Light colour White
 Required components:

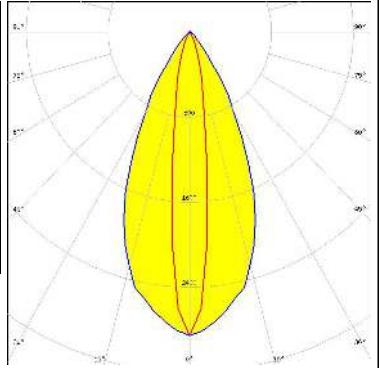

OPTICAL RESULTS (MEASURED):

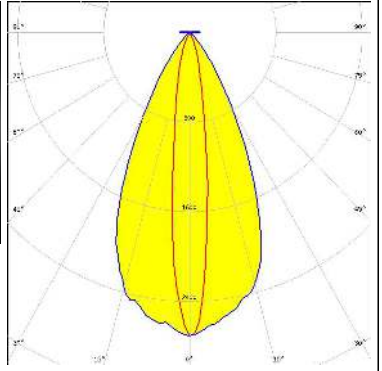
<p>LUMILEDS</p> <p>LED LUXEON C</p> <p>FWHM / FWTM 9.0 + 54.0° / 23.0 + 76.0°</p> <p>Efficiency 79 %</p> <p>Peak intensity 3.9 cd/m</p> <p>LEDs/each optic 1</p> <p>Light colour White</p> <p>Required components:</p>		
<p>LUMILEDS</p> <p>LED LUXEON CZ</p> <p>FWHM / FWTM 8.0 + 52.0° / 19.0 + 73.0°</p> <p>Efficiency 92 %</p> <p>Peak intensity 5 cd/m</p> <p>LEDs/each optic 1</p> <p>Light colour White</p> <p>Required components:</p>		
<p>NICHIA</p> <p>LED NCSxx19A</p> <p>FWHM / FWTM 10.0 + 50.0° / 30.0 + 75.0°</p> <p>Efficiency 82 %</p> <p>Peak intensity 3.5 cd/m</p> <p>LEDs/each optic 1</p> <p>Light colour White</p> <p>Required components:</p>		
<p>NICHIA</p> <p>LED NVSxx19A</p> <p>FWHM / FWTM 10.0 + 49.0° / 31.0 + 76.0°</p> <p>Efficiency 82 %</p> <p>Peak intensity 3.4 cd/m</p> <p>LEDs/each optic 1</p> <p>Light colour White</p> <p>Required components:</p>		

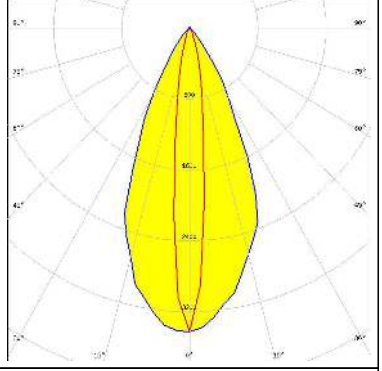
OPTICAL RESULTS (MEASURED):

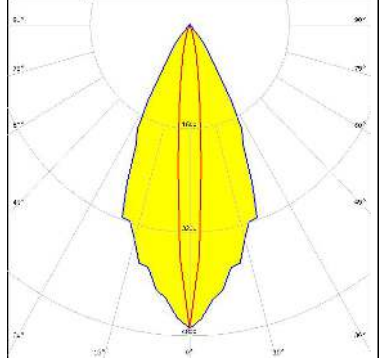
<p>NICHIA</p> <p>LED NVSxx19B/NVSxx19C FWHM / FWTM 14.0 + 48.0° / 38.0 + 78.0° Efficiency 85 % Peak intensity 2.9 cd/lm LEDs/each optic 1 Light colour White Required components:</p>		
<p>OSRAM Opto Semiconductors</p> <p>LED OSLON Square CSSRM2/CSSRM3 FWHM / FWTM 15.0 + 51.0° / 35.0 + 78.0° Efficiency 78 % Peak intensity 2.7 cd/lm LEDs/each optic 1 Light colour White Required components:</p>		
<p>OSRAM Opto Semiconductors</p> <p>LED OSLON Square EC FWHM / FWTM 12.0 + 48.0° / 34.0 + 74.0° Efficiency 86 % Peak intensity 3.4 cd/lm LEDs/each optic 1 Light colour White Required components:</p>		
<p>OSRAM Opto Semiconductors</p> <p>LED OSLON SSL 150 FWHM / FWTM 9.0 + 48.0° / 25.0 + 72.0° Efficiency 86 % Peak intensity 4.7 cd/lm LEDs/each optic 1 Light colour White Required components:</p>		

OPTICAL RESULTS (MEASURED):

OSRAM

Opto Semiconductors

LED OSLON SSL 80
 FWHM / FWTM 9.0 + 42.0° / 27.0 + 70.0°
 Efficiency 83 %
 Peak intensity 4.3 cd/lm
 LEDs/each optic 1
 Light colour White
 Required components:

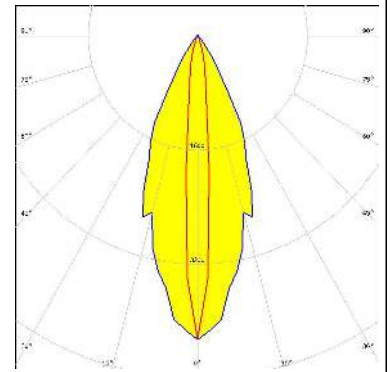

SAMSUNG

LED LH181B
 FWHM / FWTM 14.0 + 51.0° / 35.0 + 77.0°
 Efficiency 89 %
 Peak intensity 2.7 cd/lm
 LEDs/each optic 1
 Light colour White
 Required components:

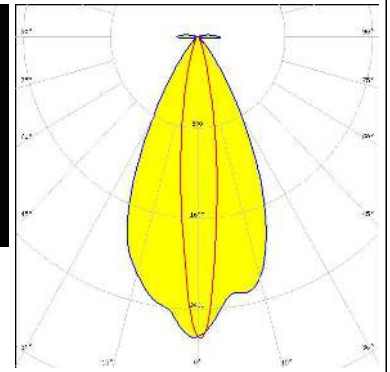
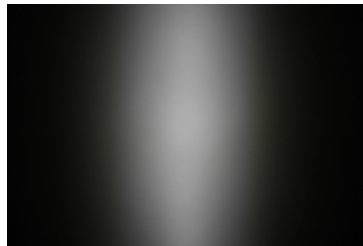

SAMSUNG

LED LH351B
 FWHM / FWTM 13.0 + 52.0° / 34.0 + 78.0°
 Efficiency 83 %
 Peak intensity 3 cd/lm
 LEDs/each optic 1
 Light colour White
 Required components:

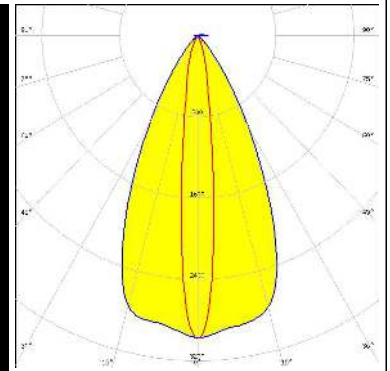
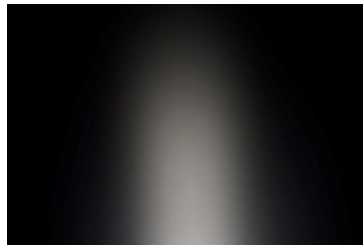

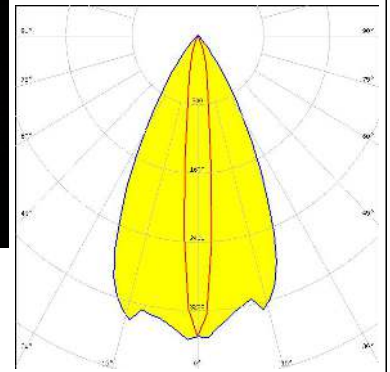
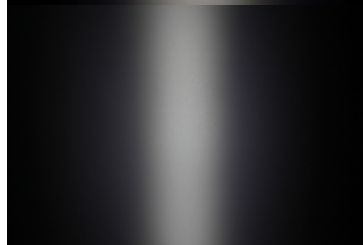

SAMSUNG

LED LH351Z
 FWHM / FWTM 11.0 + 54.0° / 31.0 + 78.0°
 Efficiency 82 %
 Peak intensity 3.5 cd/lm
 LEDs/each optic 1
 Light colour White
 Required components:

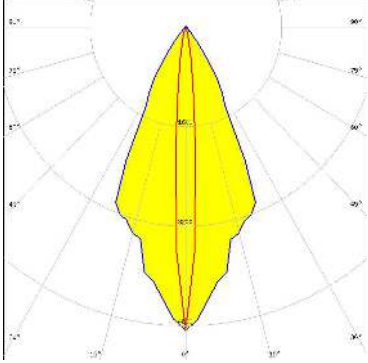

OPTICAL RESULTS (MEASURED):

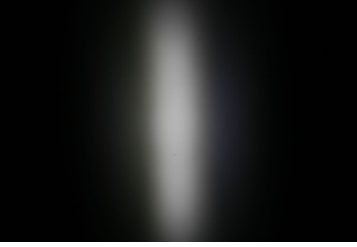
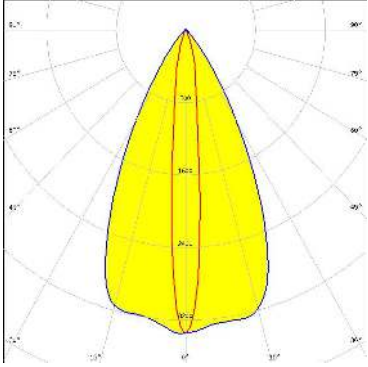
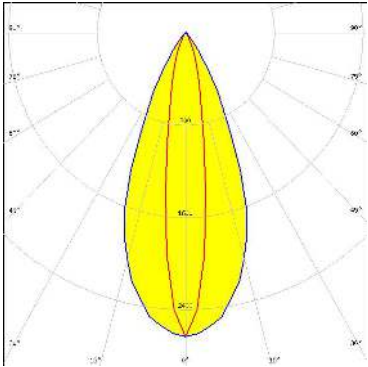
<p> SEUL SEMICONDUCTOR</p> <p>LED Z5</p> <p>FWHM / FWTM 8.0 + 50.0° / 21.0 + 72.0°</p> <p>Efficiency 86 %</p> <p>Peak intensity 4.9 cd/lm</p> <p>LEDs/each optic 1</p> <p>Light colour White</p> <p>Required components:</p>		
<p> SEUL SEMICONDUCTOR</p> <p>LED Z5M1/Z5M2</p> <p>FWHM / FWTM 11.0 + 53.0° / 31.0 + 77.0°</p> <p>Efficiency 84 %</p> <p>Peak intensity 3.4 cd/lm</p> <p>LEDs/each optic 1</p> <p>Light colour White</p> <p>Required components:</p>		
<p>SHARP</p> <p>LED Double Dome (GM2BB)</p> <p>FWHM / FWTM 16.0 + 44.0° / 40.0 + 70.0°</p> <p>Efficiency 82 %</p> <p>Peak intensity 2.6 cd/lm</p> <p>LEDs/each optic 1</p> <p>Light colour White</p> <p>Required components:</p>		

OPTICAL RESULTS (SIMULATED):

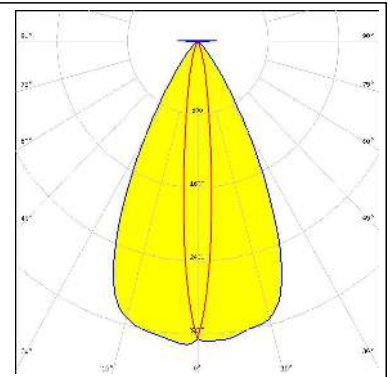
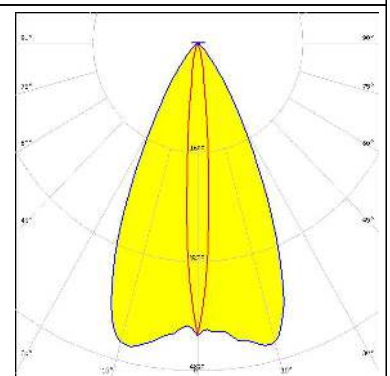
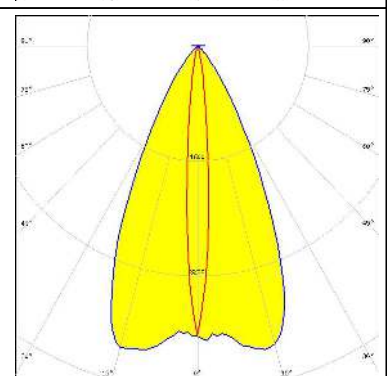
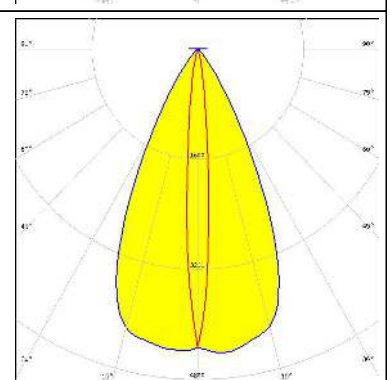
<p>LUMILEDS</p> <p>LED: LUXEON HL2Z</p> <p>FWHM / FWTM: 12.0 + 54.0° / 28.0 + 76.0°</p> <p>Efficiency: 88 %</p> <p>Peak intensity: 3.3 cd/lm</p> <p>LEDs/each optic: 1</p> <p>Light colour: White</p> <p>Required components:</p>	
<p>LUMILEDS</p> <p>LED: LUXEON SunPlus 20 Line (120 deg)</p> <p>FWHM / FWTM: 9.0 + 52.0° / 22.0 + 76.0°</p> <p>Efficiency: 91 %</p> <p>Peak intensity: 4.6 cd/lm</p> <p>LEDs/each optic: 1</p> <p>Light colour: White</p> <p>Required components:</p>	
<p>LUMILEDS</p> <p>LED: LUXEON SunPlus 20 Line (150 deg)</p> <p>FWHM / FWTM: 9.0 + 52.0° / 20.0 + 76.0°</p> <p>Efficiency: 87 %</p> <p>Peak intensity: 4.3 cd/lm</p> <p>LEDs/each optic: 1</p> <p>Light colour: White</p> <p>Required components:</p>	
<p>LUMILEDS</p> <p>LED: LUXEON Z ES</p> <p>FWHM / FWTM: 8.7 + 52.0° / 21.0 + 74.0°</p> <p>Efficiency: 92 %</p> <p>Peak intensity: 4.4 cd/lm</p> <p>LEDs/each optic: 1</p> <p>Light colour: White</p> <p>Required components:</p>	

OPTICAL RESULTS (SIMULATED):

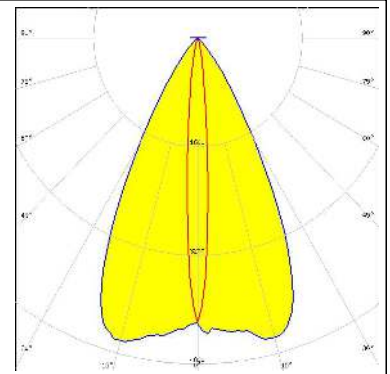
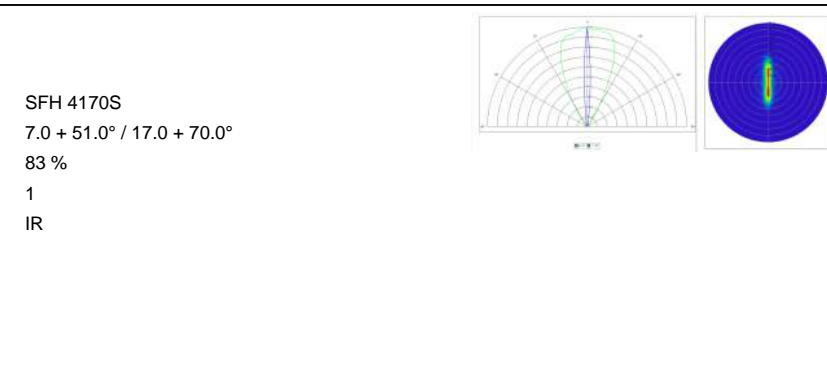
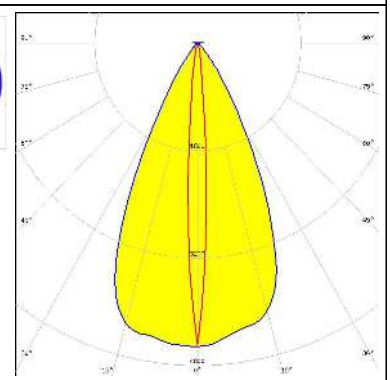
<p>OSRAM Opto Semiconductors</p> <p>LED OSCONIQ P 3030</p> <p>FWHM / FWTM 7.9 + 55.0° / 20.0 + 77.0°</p> <p>Efficiency 93 %</p> <p>Peak intensity 4.6 cd/lm</p> <p>LEDs/each optic 1</p> <p>Light colour White</p> <p>Required components:</p>		
<p>OSRAM Opto Semiconductors</p> <p>LED SFH 4170S</p> <p>FWHM / FWTM 7.0 + 51.0° / 17.0 + 70.0°</p> <p>Efficiency 83 %</p> <p>LEDs/each optic 1</p> <p>Light colour IR</p> <p>Required components:</p>		

GENERAL INFORMATION:

NOTE: The typical beam angle will be changed by different color, chip size and chip position tolerance. The typical total beam angle is the full angle measured where the luminous intensity is half of the peak value.

MATERIALS:

As part of our continuous research and improvement processes, and to ensure the best possible quality and availability of our products, LEDiL reserves the right to change material grades without notice.

PRODUCT DATA USER AGREEMENT AND DISCLAIMER:

The measured data in the provided downloadable LEDiL Product Datasheets and Mechanical 2D-Drawings is rounded and provided as reference for planning. LEDiL Oy's optical specifications have been verified by conducting performance testing of the products in accordance with the company's quality system. The reported data are averaged results of multiple measurements with typical variation. LEDiL Oy reserves the right to without prior notification make changes and improvements to its products.

LEDiL Oy assumes neither warranty, nor guarantee nor any other liability of any kind for the contents and correctness of the provided data. The provided data has been generated with highest diligence but the provided data may in reality not represent the complete possible variation range of all intrinsic parameters. Therefore, in certain cases a deviation from the provided data could occur.

LEDiL Oy reserves the right to undertake technical changes of its products without further notification which could lead to changes in the provided data. LEDiL Oy assumes no liability of any kind for the possible deviation from any provided data or any other damage resulting from the usage of the provided data.

The user agrees to this disclaimer and user agreement with the download or usage of the provided files.

LEDiL Oy

Joensuunkatu 13
FI-24240 SALO
Finland

LEDiL Inc.

228 West Page Street
Suite D
Sycamore IL 60178
USA

Ledil Optics Technology (Shenzhen) Co., Ltd.

405 , Block B
Casic Motor Building
Shenzhen 518057
P.R.CHINA

Local sales and technical support

[www.ledil.com/
where_to_buy](http://www.ledil.com/where_to_buy)

Shipping locations

Salo, Finland
Hong Kong, China

Distribution Partners

[www.ledil.com/
where_to_buy](http://www.ledil.com/where_to_buy)